

60 V, 2 A low drop power Schottky rectifier

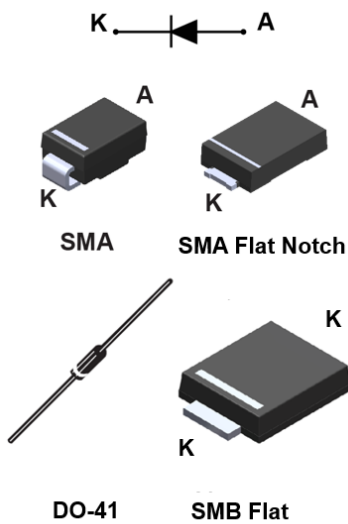

Features

- Negligible switching losses
- Low forward voltage drop for higher efficiency and extended battery life
- Surface mount miniature package
- Avalanche rated
- ECOPACK2 compliant component

Applications

- Lighting
- Desktop power supply
- Battery charger
- Set top box
- Auxiliary power

Description

This 60 V power Schottky rectifier is ideal for switch mode power supplies and high frequency converters.

Packaged in SMA, SMA Flat Notch, axial and SMB Flat, the **STPS2L60** is optimized for use in low voltage, high frequency inverters and small battery chargers.

Product status	
STPS2L60	
Product summary	
Symbol	Values
$I_{F(AV)}$	2 A
V_{RRM}	60 V
T_j (max.)	150 °C
V_F (typ.)	0.51 V

1 Characteristics

Table 1. Absolute ratings (limiting values, at 25 °C, unless otherwise specified)

Symbol	Parameter		Value	Unit	
V _{RRM}	Repetitive peak reverse voltage		60	V	
I _{F(RMS)}	Forward rms current		10	A	
I _{F(AV)}	Average forward current $\delta = 0.5$, square wave	SMB Flat	T _L = 130 °C	2	A
		SMA	T _L = 115 °C		
		SMA Flat Notch	T _L = 120 °C		
		DO-41	T _L = 110 °C		
I _{FSM}	Surge non repetitive forward current	SMB Flat, SMA, DO-41	t _p = 10 ms sinusoidal	75	A
		SMA Flat Notch		105	
P _{ARM}	Repetitive peak avalanche power	t _p = 10 μ s, T _j = 125 °C		115	W
T _{stg}	Storage temperature range		-65 to + 150	°C	
T _j	Maximum operating junction temperature ⁽¹⁾		+ 150	°C	

1. $(dP_{tot}/dT_j) < (1/R_{th(j-a)})$ condition to avoid thermal runaway for a diode on its own heatsink.

Table 2. Thermal resistance parameter

Symbol	Parameter		Max. value	Unit
R _{th(j-l)}	Junction to lead	SMB Flat	15	°C/W
		SMA	25	
		SMA Flat Notch	20	
	Junction to lead	Lead length = 10 mm	DO-41	

For more information, please refer to the following application note :

- AN5088 : Rectifiers thermal management, handling and mounting recommendations

Table 3. Static electrical characteristics

Symbol	Parameter	Test conditions		Min.	Typ.	Max.	Unit
I _R ⁽¹⁾	Reverse leakage current	T _j = 25 °C	V _R = V _{RRM}	-		100	μ A
		T _j = 100 °C		-	2	10	mA
V _F ⁽¹⁾	Forward voltage drop	T _j = 25 °C	I _F = 2 A	-		0.60	V
		T _j = 125 °C		-	0.51	0.55	
		T _j = 25 °C	I _F = 4 A	-		0.77	
		T _j = 125 °C		-	0.62	0.67	

1. Pulse test: t_p = 380 μ s, $\delta < 2\%$

To evaluate the conduction losses use the following equation: $P = 0.43 \times I_{F(AV)} + 0.06 I_{F(RMS)}^2$

For more information, please refer to the following application notes related to the power losses :

- AN604: Calculation of conduction losses in a power rectifier
- AN4021: Calculation of reverse losses on a power diode

1.1 Characteristics (curves)

Figure 1. Average forward power dissipation versus average forward current

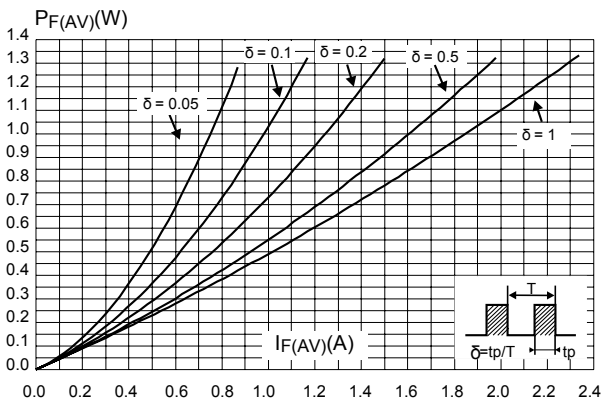

Figure 2. Average forward current versus ambient temperature ($\delta = 0.5$, DO-41, SMA)

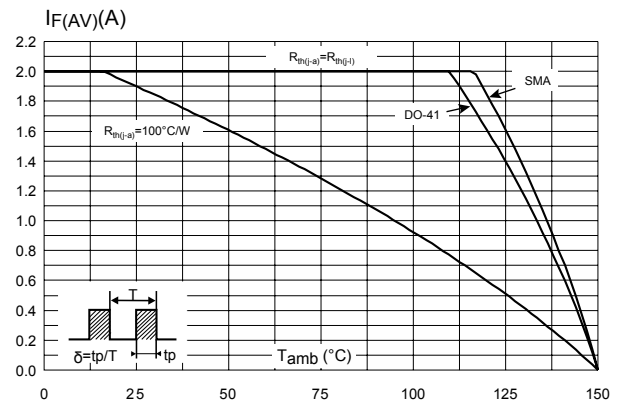

Figure 3. Average forward current versus ambient temperature ($\delta = 0.5$, SMB Flat)

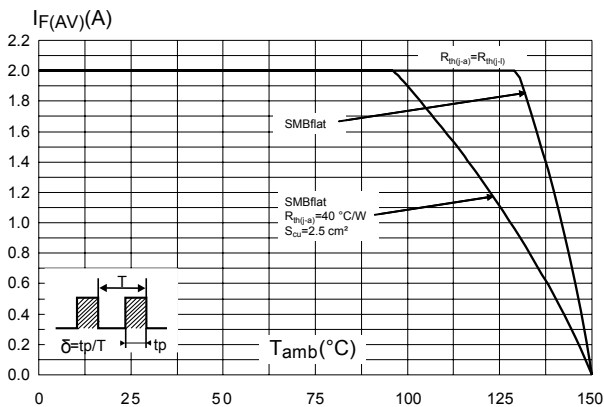

Figure 4. Normalized avalanche power derating versus pulse duration ($T_j = 125^\circ\text{C}$)

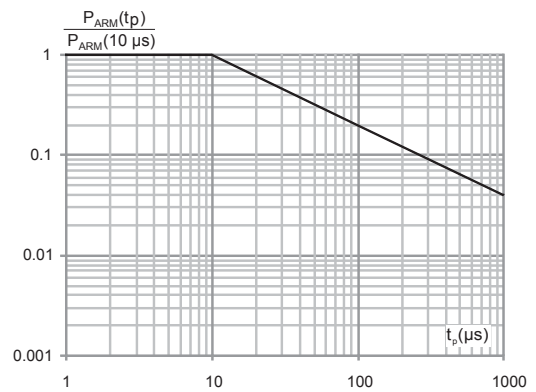

Figure 5. Relative variation of thermal impedance junction to ambient versus pulse duration (SMA)

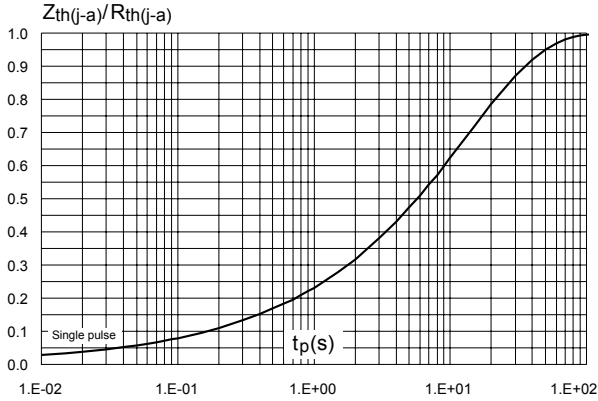

Figure 6. Relative variation of thermal impedance junction to ambient versus pulse duration (DO-41)

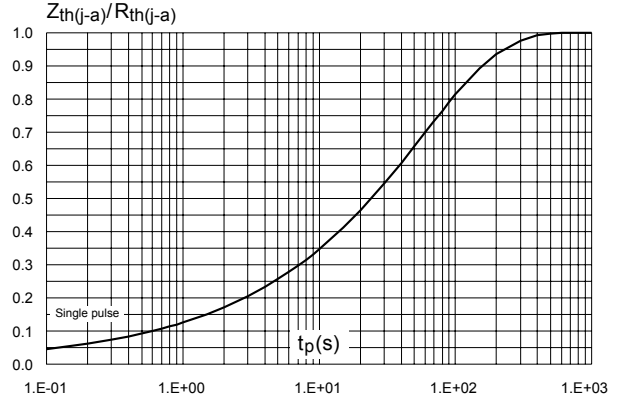

Figure 7. Relative variation of thermal impedance junction to lead versus pulse duration (SMB Flat)

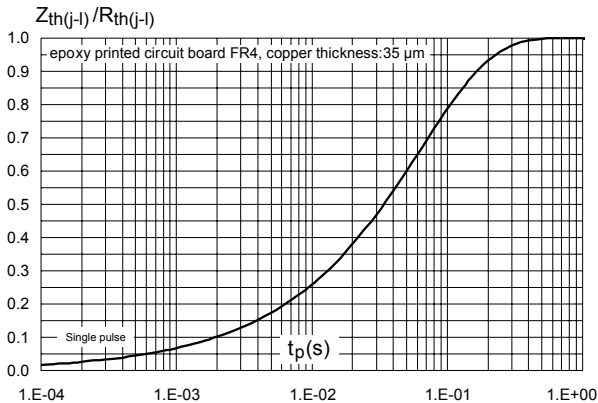

Figure 8. Junction capacitance versus reverse voltage applied (typical values)

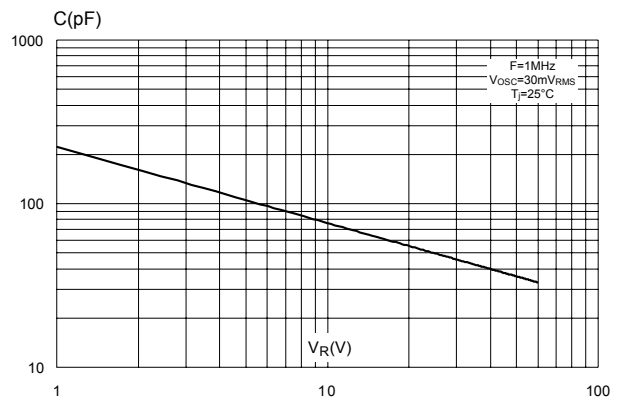

Figure 9. Reverse leakage current versus reverse voltage applied (typical values)

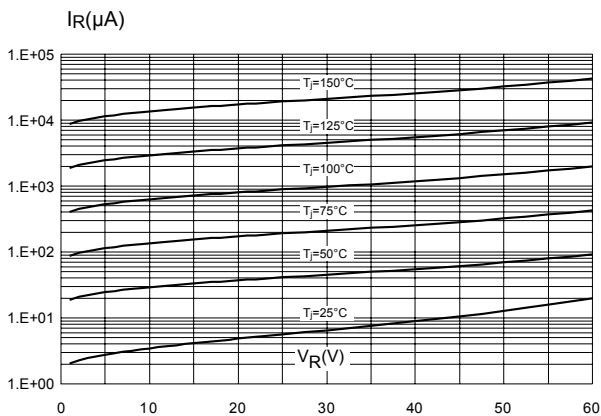

Figure 10. Forward voltage drop versus forward current

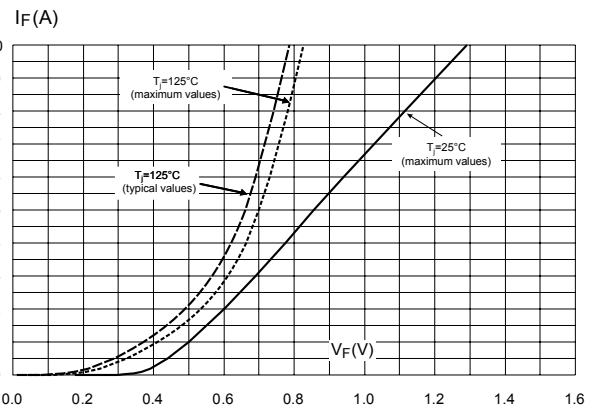

Figure 11. Thermal resistance junction to ambient versus copper surface under each lead (SMA)

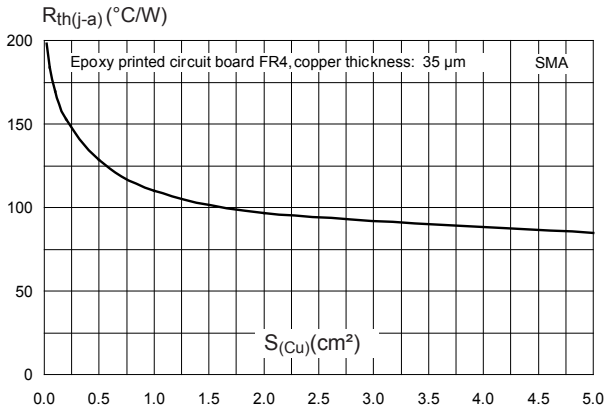

Figure 12. Thermal resistance versus lead length (DO-41)

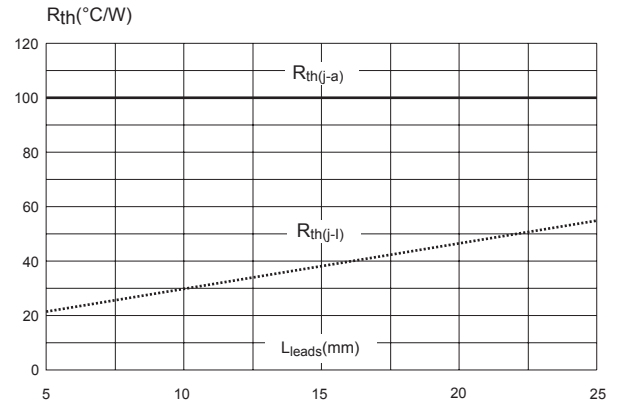

Figure 13. Thermal resistance junction to ambient versus copper surface under each lead (SMB Flat)

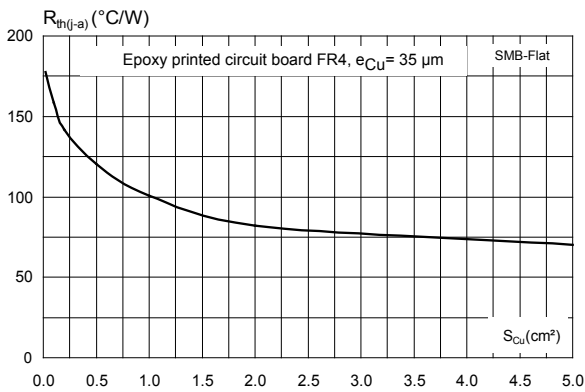
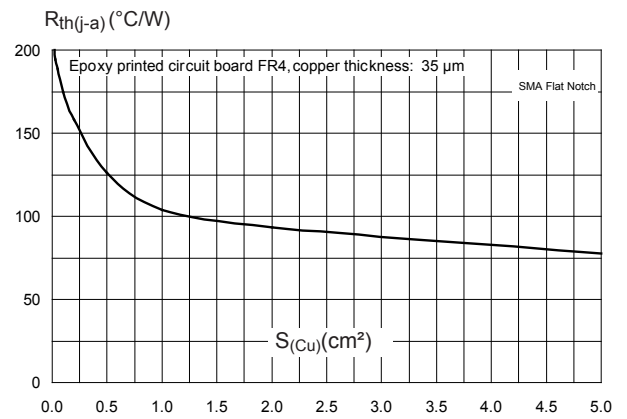

Figure 14. Thermal resistance junction to ambient versus copper surface under each lead (SMA Flat Notch)



2 Package information

In order to meet environmental requirements, ST offers these devices in different grades of **ECOPACK** packages, depending on their level of environmental compliance. ECOPACK specifications, grade definitions and product status are available at: www.st.com. ECOPACK is an ST trademark.

2.1 SMA package information

- Epoxy meets UL94, V0
- Cooling method : by conduction (C)

Figure 15. SMA package outline

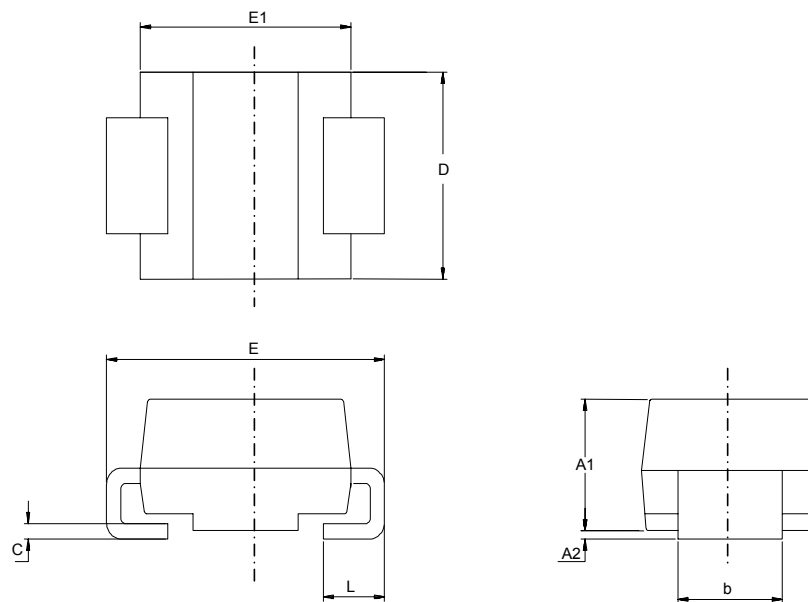
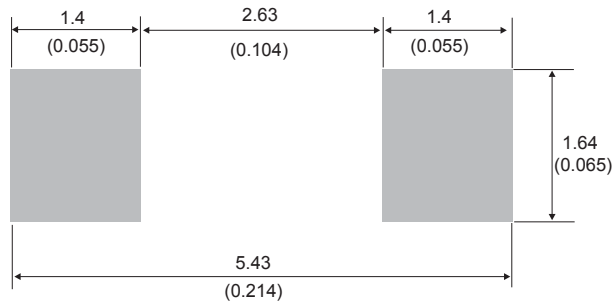

Table 4. SMA package mechanical data

Ref.	Dimensions			
	Millimeters		Inches (for reference only)	
	Min.	Max.	Min.	Max.
A1	1.90	2.45	0.074	0.097
A2	0.05	0.20	0.001	0.008
b	1.25	1.65	0.049	0.065
c	0.15	0.40	0.005	0.016
D	2.25	2.90	0.088	0.115
E	4.80	5.35	0.188	0.211
E1	3.95	4.60	0.155	0.182
L	0.75	1.50	0.029	0.060

Figure 16. SMA recommended footprint in mm (inches)



2.2 SMA Flat Notch package information

- Epoxy meets UL94, V0
- Cooling method: by conduction (C)
- Band indicates cathode

Figure 17. SMA Flat Notch package outline

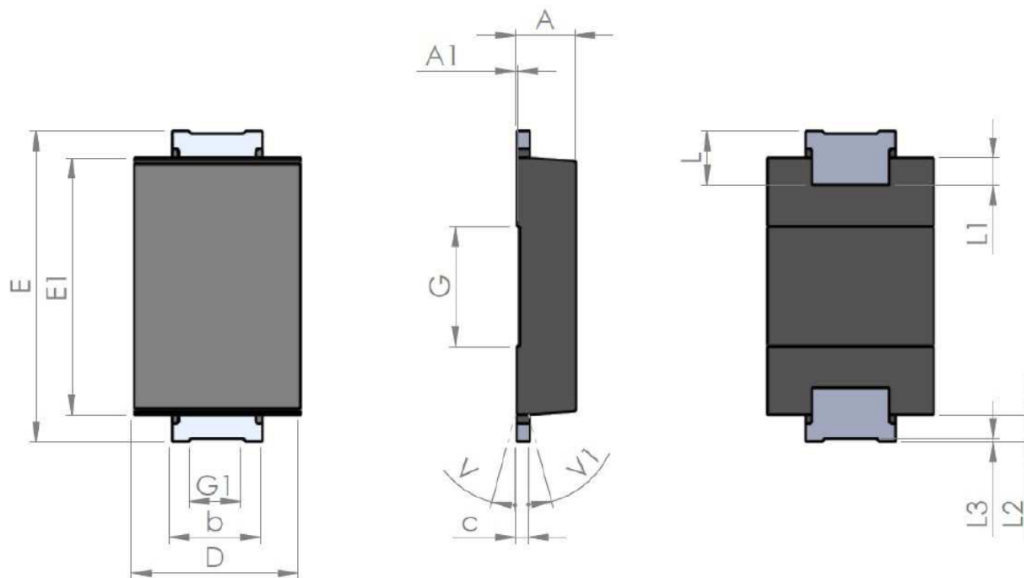
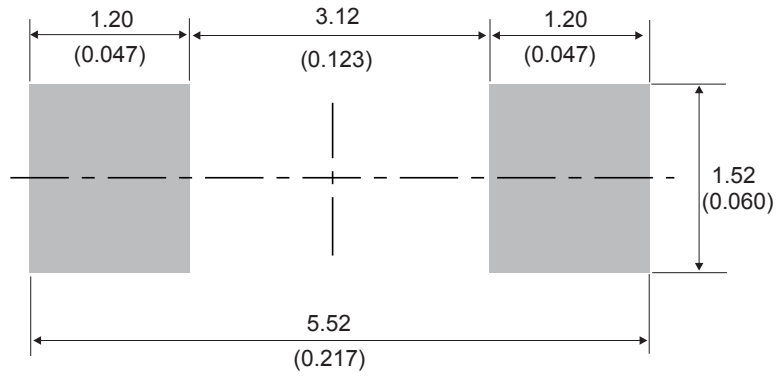

Table 5. SMA Flat Notch package mechanical data

Ref.	Dimensions					
	Millimeters			Inches (for reference only)		
	Min.	Typ.	Max.	Min.	Typ.	Max.
A1	0.90		1.10	0.035		0.044
A1		0.05			0.002	
b	1.25		1.65	0.049		0.065
C	0.15		0.40	0.005		0.016
D	2.25		2.90	0.088		0.115
E	5.00		5.35	0.196		0.211
E1	3.95		4.60	0.155		0.182
G		2.00			0.079	
G1		0.85			0.033	
L	0.75		1.20	0.029		
L1		0.45			0.018	
L2		0.45			0.018	
L3		0.05			0.002	
V			8°			8°
V1			8°			8°

Figure 18. SMA Flat Notch recommended footprint in mm (inches)



2.3 SMB Flat package information

- Epoxy meets UL94, V0
- Lead-free package

Figure 19. SMB Flat package outline

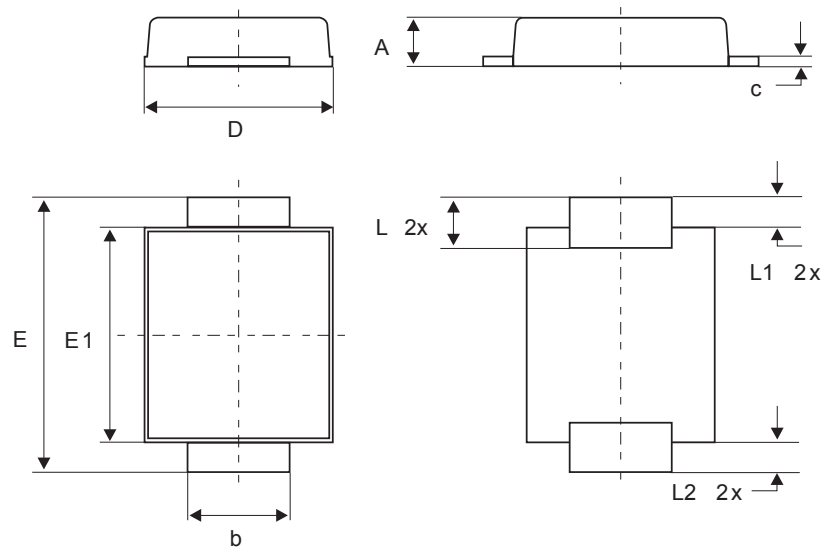
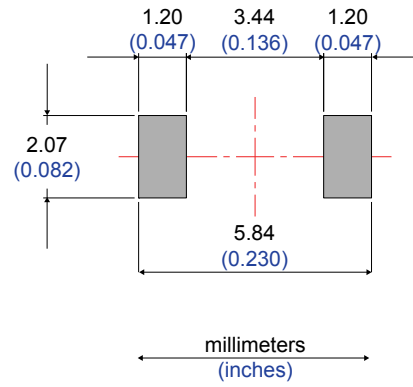

Table 6. SMB Flat mechanical data

Ref.	Dimensions					
	Millimeters			Inches (for reference only)		
	Min.	Typ.	Max.	Min.	Typ.	Max.
A	0.90		1.10	0.035		0.043
b	1.95		2.20	0.077		0.087
c	0.15		0.40	0.006		0.016
D	3.30		3.95	0.130		0.156
E	5.10		5.60	0.201		0.220
E1	4.05		4.60	0.159		0.181
L	0.75		1.50	0.030		0.059
L1		0.40			0.016	
L2		0.60			0.024	

Figure 20. Footprint recommendations, dimensions in mm (inches)



2.4 DO-41 Package information

- Epoxy meets UL 94, V0

Figure 21. DO-41 package outline

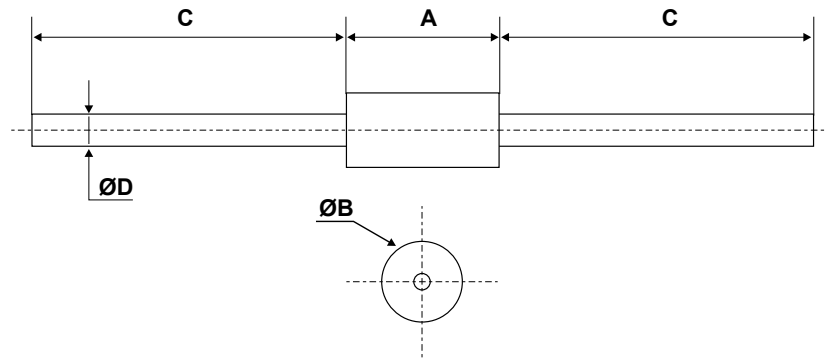

Table 7. DO-41 package mechanical data

Ref.	Dimensions					
	Millimeters			Inches (for reference only)		
	Min.	Typ.	Max.	Min.	Typ.	Max.
A	4.1	-	5.20	0.160	-	0.205
B	2.00	-	2.71	0.080	-	0.107
C	25.40	-		1.000	-	
D	0.71	-	0.86	0.028	-	0.0034

3 Ordering information

Table 8. Ordering information

Order code	Marking	Package	Weight	Base qty.	Delivery mode
STPS2L60A	S26	SMA	0.068 g	5000	Tape and reel
STPS2L60AFN	A26	SMA Flat Notch	0.039 g	10 000	Tape and reel
STPS2L60	STPS2L60	DO-41	0.34 g	2000	Ammopack
STPS2L60UF	FG26	SMB Flat	0.050 g	5000	Tape and reel

Revision history

Table 9. Document revision history

Date	Version	Changes
Jul-2003	2A	Last update.
Aug-2004	3	SMA package dimensions update. Reference A1 max changed from 2.70 mm (0.106 inch) to 2.03 mm (0.080 inch).SMA package dimensions update. Reference A1 max changed from 2.70 mm (0.106 inch) to 2.03 mm (0.080 inch).
18-Sep-2008	4	Reformatted to current standards. Added SMB flat package.
30-Sep-2009	5	Updated table 7 package dimensions.
23-Sep-2011	6	Updated SMA package information.
30-Nov-2018	7	Updated Table 1. Absolute ratings (limiting values, at 25 °C, unless otherwise specified) and Figure 4. Normalized avalanche power derating versus pulse duration (T_j = 125 °C) .
27-Sep-2019	8	Added Section 2.2 SMA Flat Notch package information .

IMPORTANT NOTICE – PLEASE READ CAREFULLY

STMicroelectronics NV and its subsidiaries (“ST”) reserve the right to make changes, corrections, enhancements, modifications, and improvements to ST products and/or to this document at any time without notice. Purchasers should obtain the latest relevant information on ST products before placing orders. ST products are sold pursuant to ST’s terms and conditions of sale in place at the time of order acknowledgement.

Purchasers are solely responsible for the choice, selection, and use of ST products and ST assumes no liability for application assistance or the design of Purchasers’ products.

No license, express or implied, to any intellectual property right is granted by ST herein.

Resale of ST products with provisions different from the information set forth herein shall void any warranty granted by ST for such product.

ST and the ST logo are trademarks of ST. For additional information about ST trademarks, please refer to www.st.com/trademarks. All other product or service names are the property of their respective owners.

Information in this document supersedes and replaces information previously supplied in any prior versions of this document.

© 2019 STMicroelectronics – All rights reserved