

74LVTH162374

Low Voltage 16-Bit D-Type Flip-Flop with 3-STATE Outputs and 25Ω Series Resistors in the Outputs

Features

- Input and output interface capability to systems at 5V V_{CC}
- Bushold data inputs eliminate the need for external pull-up resistors to hold unused inputs
- Live insertion/extraction permitted
- Power Up/Power Down high impedance provides glitch-free bus loading
- Outputs include equivalent series resistance of 25Ω to make external termination resistors unnecessary and reduce overshoot and undershoot
- Functionally compatible with the 74 series 16374
- Latch-up performance exceeds 500mA
- ESD performance:
 - Human-body model > 2000V
 - Machine model > 200V
 - Charged-device model > 1000V
- Also packaged in plastic Fine-Pitch Ball Grid Array (FBGA) (Preliminary)

General Description

The LVTH162374 contains sixteen non-inverting D-type flip-flops with 3-STATE outputs and is intended for bus oriented applications. The device is byte controlled. A buffered clock (CP) and Output Enable (\overline{OE}) are common to each byte and can be shorted together for full 16-bit operation.

The LVTH162374 is designed with equivalent 25Ω series resistance in both the HIGH and LOW states of the output. This design reduces line noise in applications such as memory address drivers, clock drivers, and bus transceivers/transmitters.

The LVTH162374 data inputs include bushold, eliminating the need for external pull-up resistors to hold unused inputs.

These flip-flops are designed for low-voltage (3.3V) V_{CC} applications, but with the capability to provide a TTL interface to a 5V environment. The LVTH162374 is fabricated with an advanced BiCMOS technology to achieve high speed operation similar to 5V ABT while maintaining a low power dissipation.

Ordering Information

Order Number	Package Number	Pb-Free	Package Description	Supplied As
74LVTH162374GX ⁽¹⁾	BGA54A (Preliminary)	Yes	54-Ball Fine-Pitch Ball Grid Array (FBGA), JEDEC MO-205, 5.5mm Wide	Tape and Reel
74LVTH162374MEA	MS48A	Yes	48-Lead Small Shrink Outline Package (SSOP), JEDEC MO-118, 0.300" Wide	Tubes
74LVTH162374MEX	MS48A	Yes	48-Lead Small Shrink Outline Package (SSOP), JEDEC MO-118, 0.300" Wide	Tape and Reel
74LVTH162374MTD	MTD48	Yes	48-Lead Thin Shrink Small Outline Package (TSSOP), JEDEC MO-153, 6.1mm Wide	Tubes
74LVTH162374MTX	MTD48	Yes	48-Lead Thin Shrink Small Outline Package (TSSOP), JEDEC MO-153, 6.1mm Wide	Tape and Reel

Notes:

1. BGA package available in Tape and Reel only.

Connection Diagrams

Pin Assignments for SSOP and TSSOP

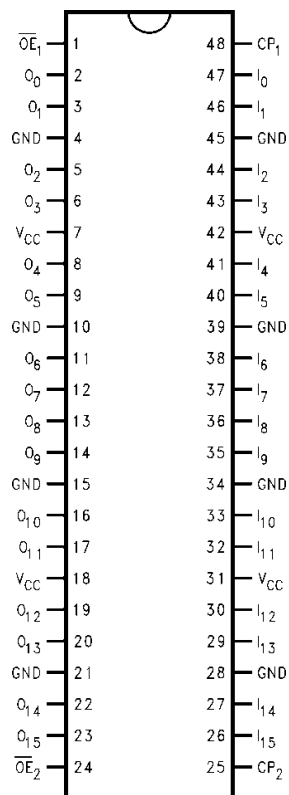

Pin Assignment for FPGA

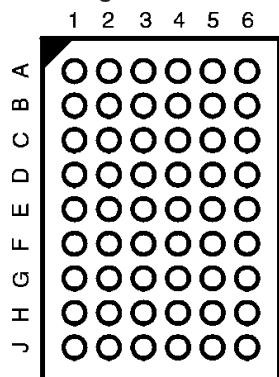

(Top Thru View)

Pin Description

Pin Name	Description
\overline{OE}_n	Output Enable Input (Active LOW)
CP_n	Clock Pulse Input
I_0-I_{15}	Inputs
O_0-O_{15}	3-STATE Outputs
NC	No Connect

FBGA Pin Assignments

	1	2	3	4	5	6
A	O_0	NC	\overline{OE}_1	CP_1	NC	I_0
B	O_2	O_1	NC	NC	I_1	I_2
C	O_4	O_3	V_{CC}	V_{CC}	I_3	I_4
D	O_6	O_5	GND	GND	I_5	I_6
E	O_8	O_7	GND	GND	I_7	I_8
F	O_{10}	O_9	GND	GND	I_9	I_{10}
G	O_{12}	O_{11}	V_{CC}	V_{CC}	I_{11}	I_{12}
H	O_{14}	O_{13}	NC	NC	I_{13}	I_{14}
J	O_{15}	NC	\overline{OE}_2	CP_2	NC	I_{15}

Logic Symbol

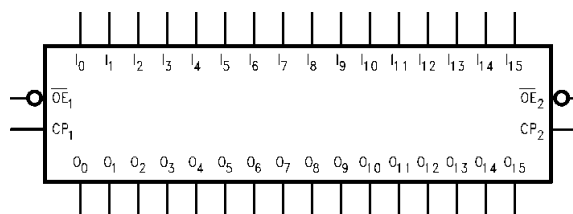

Truth Tables

Inputs			Outputs
CP_1	\overline{OE}_1	I_0-I_7	O_0-O_7
\nearrow	L	H	H
\nearrow	L	L	L
L	L	X	O_o
X	H	X	Z

Inputs			Outputs
CP_2	\overline{OE}_2	I_8-I_{15}	O_8-O_{15}
\nearrow	L	H	H
\nearrow	L	L	L
L	L	X	O_o
X	H	X	Z

H = HIGH Voltage Level

L = LOW Voltage Level

X = Immaterial

Z = HIGH Impedance

O_o = Previous O_o before LOW-to-HIGH of CP

Functional Description

The LVTH162374 consists of sixteen edge-triggered flip-flops with individual D-type inputs and 3-STATE true outputs. The device is byte controlled with each byte functioning identically, but independent of the other. The control pins can be shorted together to obtain full 16-bit operation. Each byte has a buffered clock and buffered Output Enable common to all flip-flops within that byte. The description which follows applies to each byte. Each

flip-flop will store the state of their individual D-type inputs that meet the setup and hold time requirements on the LOW-to-HIGH Clock (CP_n) transition. With the Output Enable (\overline{OE}_n) LOW, the contents of the flip-flops are available at the outputs. When \overline{OE}_n is HIGH, the outputs go to the high impedance state. Operation of the \overline{OE}_n input does not affect the state of the flip-flops.

Logic Diagrams

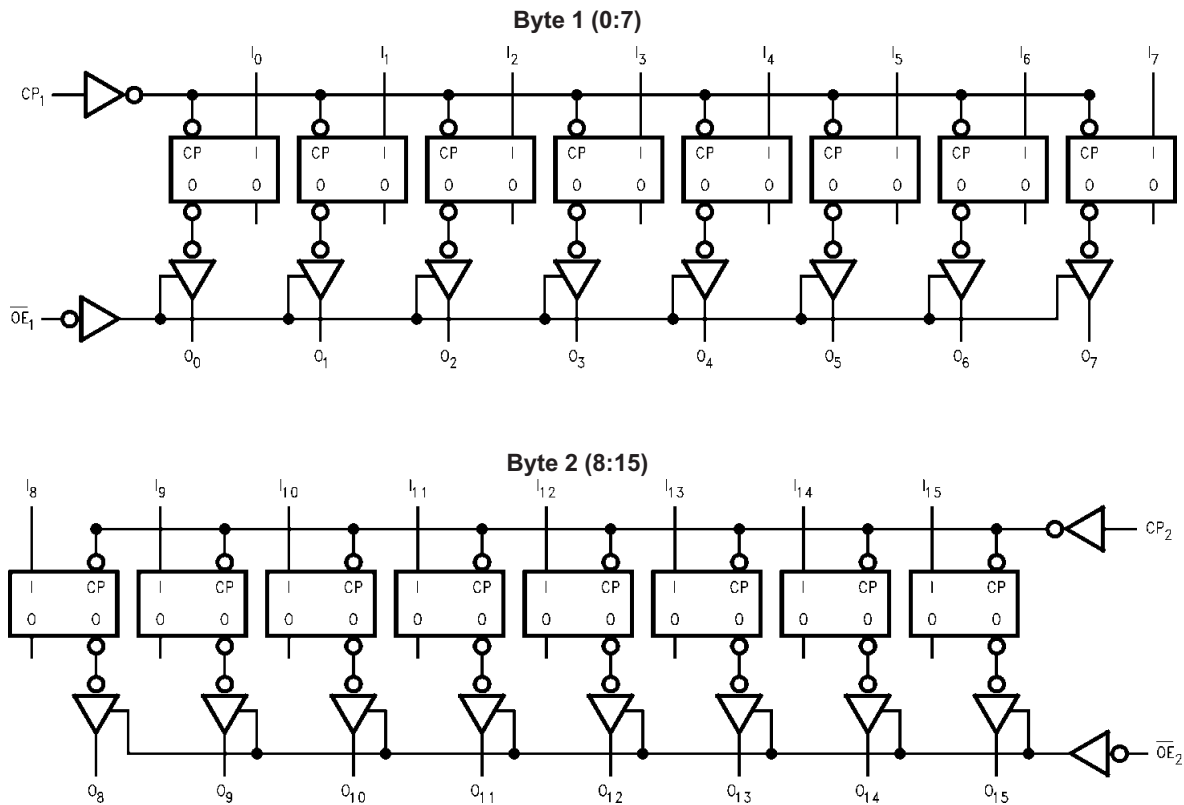

Please note that these diagrams are provided for the understanding of logic operation and should not be used to estimate propagation delays.

Absolute Maximum Ratings

Stresses exceeding the absolute maximum ratings may damage the device. The device may not function or be operable above the recommended operating conditions and stressing the parts to these levels is not recommended. In addition, extended exposure to stresses above the recommended operating conditions may affect device reliability. The absolute maximum ratings are stress ratings only.

Symbol	Parameter	Conditions	Value	Units
V_{CC}	Supply Voltage		-0.5 to +4.6	V
V_I	DC Input Voltage		-0.5 to +7.0	V
V_O	DC Output Voltage	Output in 3-STATE	-0.5 to +7.0	V
		Output in HIGH or LOW State ⁽²⁾	-0.5 to +7.0	
I_{IK}	DC Input Diode Current	$V_I < GND$	-50	mA
I_{OK}	DC Output Diode Current	$V_O < GND$	-50	mA
I_O	DC Output Current	$V_O > V_{CC}$ Output at HIGH State	64	mA
		$V_O > V_{CC}$ Output at LOW State	128	
I_{CC}	DC Supply Current per Supply Pin		±64	mA
I_{GND}	DC Ground Current per Ground Pin		±128	mA
T_{STG}	Storage Temperature		-65 to +150	°C

Note:

- I_O Absolute Maximum Rating must be observed.

Recommended Operating Conditions

The Recommended Operating Conditions table defines the conditions for actual device operation. Recommended operating conditions are specified to ensure optimal performance to the datasheet specifications. Fairchild does not recommend exceeding them or designing to absolute maximum ratings.

Symbol	Parameter	Min.	Max.	Units
V_{CC}	Supply Voltage	2.7	3.6	V
V_I	Input Voltage	0	5.5	V
I_{OH}	HIGH Level Output Current		-12	mA
I_{OL}	LOW Level Output Current		12	mA
T_A	Free-Air Operating Temperature	-40	85	°C
$\Delta t/\Delta V$	Input Edge Rate, $V_{IN} = 0.8V-2.0V$, $V_{CC} = 3.0V$	0	10	ns/V

DC Electrical Characteristics

Symbol	Parameter	V _{CC} (V)	Conditions	T _A = -40°C to +85°C		Units	
				Min.	Max.		
V _{IK}	Input Clamp Diode Voltage	2.7	I _I = -18mA		-1.2	V	
V _{IH}	Input HIGH Voltage	2.7–3.6	V _O ≤ 0.1V or V _O ≥ V _{CC} – 0.1V	2.0		V	
V _{IL}	Input LOW Voltage	2.7–3.6			0.8	V	
V _{OH}	Output HIGH Voltage	2.7–3.6	I _{OH} = -100μA	V _{CC} – 0.2V		V	
		3.0	I _{OH} = -12mA	2.0			
V _{OL}	Output LOW Voltage	2.7	I _{OL} = 100μA		0.2	V	
		3.0	I _{OL} = 12mA		0.8		
I _{I(HOLD)}	Bushold Input Minimum Drive	3.0	V _I = 0.8V	75		μA	
			V _I = 2.0V	-75			
I _{I(OD)}	Bushold Input Over-Drive Current to Change State	3.0	(3)	500		μA	
			(4)	-500			
I _I	Input Current	3.6	V _I = 5.5V		10	μA	
			Control Pins	V _I = 0V or V _{CC}			±1
			Data Pins	V _I = 0V			-5
				V _I = V _{CC}			1
I _{OFF}	Power Off Leakage Current	0	0V ≤ V _I or V _O ≤ 5.5V		±100	μA	
I _{PU/PD}	Power Up/Down 3-STATE Output Current	0–1.5	V _O = 0.5V to 3.0V, V _I = GND or V _{CC}		±100	μA	
I _{OZL}	3-STATE Output Leakage Current	3.6	V _O = 0.5V		-5	μA	
I _{OZH}	3-STATE Output Leakage Current	3.6	V _O = 3.0V		5	μA	
I _{OZH+}	3-STATE Output Leakage Current	3.6	V _{CC} < V _O ≤ 5.5V		10	μA	
I _{CCH}	Power Supply Current	3.6	Outputs HIGH		0.19	mA	
I _{CCL}	Power Supply Current	3.6	Outputs LOW		5	mA	
I _{CCZ}	Power Supply Current	3.6	Outputs Disabled		0.19	mA	
I _{CCZ+}	Power Supply Current	3.6	V _{CC} ≤ V _O ≤ 5.5V, Outputs Disabled		0.19	mA	
ΔI _{CC}	Increase in Power Supply Current ⁽⁵⁾	3.6	One Input at V _{CC} – 0.6V Other Inputs at V _{CC} or GND		0.2	mA	

Notes:

- An external driver must source at least the specified current to switch from LOW-to-HIGH.
- An external driver must sink at least the specified current to switch from HIGH-to-LOW.
- This is the increase in supply current for each input that is at the specified voltage level rather than V_{CC} or GND.

Dynamic Switching Characteristics⁽⁶⁾

Symbol	Parameter	V _{CC} (V)	Conditions C _L = 50pF, R _L = 500Ω	T _A = -40°C to +85°C			Units
				Min.	Typ.	Max	
V _{OLP}	Quiet Output Maximum Dynamic V _{OL}	3.3	(7)		0.8		V
V _{OLV}	Quiet Output Minimum Dynamic V _{OL}	3.3	(7)		-0.8		V

Note:

6. Characterized in SSOP package. Guaranteed parameter, but not tested.
7. Max number of outputs defined as (n). n-1 data inputs are driven 0V to 3V. Output under test held LOW.

AC Electrical Characteristics

Symbol	Parameter	T _A = -40°C to +85°C, C _L = 50pF, R _L = 500Ω				Units
		V _{CC} = 3.3V ±0.3V		V _{CC} = 2.7V		
		Min.	Max.	Min.	Max.	
f _{MAX}	Maximum Clock Frequency	160		150		MHz
t _{PHL}	Propagation Delay, CP to On	2.0	5.1	2.0	5.3	ns
t _{PLH}		1.6	5.3	1.6	6.2	
t _{PZL}	Output Enable Time	1.8	5.0	1.8	6.0	ns
t _{PZH}		1.2	5.6	1.2	6.9	
t _{PLZ}	Output Disable Time	1.9	5.0	1.9 2.0	5.1	ns
t _{PHZ}		2.0	5.4		5.7	
t _S	Setup Time	1.8		2.0		ns
t _H	Hold Time	0.8		0.1		ns
t _W	Pulse Width	3.0		3.0		ns
t _{OSHL}	Output to Output Skew ⁽⁸⁾		1.0		1.0	ns
t _{OSLH}			1.0		1.0	

Note:

8. Skew is defined as the absolute value of the difference between the actual propagation delay for any two separate outputs of the same device. The specification applies to any outputs switching in the same direction, either HIGH-to-LOW (t_{OSHL}) or LOW-to-HIGH (t_{OSLH}).

Capacitance⁽⁹⁾

Symbol	Parameter	Conditions	Typ.	Units
C _{IN}	Input Capacitance	V _{CC} = OPEN, V _I = 0V or V _{CC}	4	pF
C _{PD}	Power Dissipation Capacitance	V _{CC} = 3.0V, V _O = 0V or V _{CC}	8	pF

Note:

9. Capacitance is measured at frequency f = 1MHz, per MIL-STD-883, Method 3012.

Physical Dimensions

Dimensions are in millimeters unless otherwise noted.

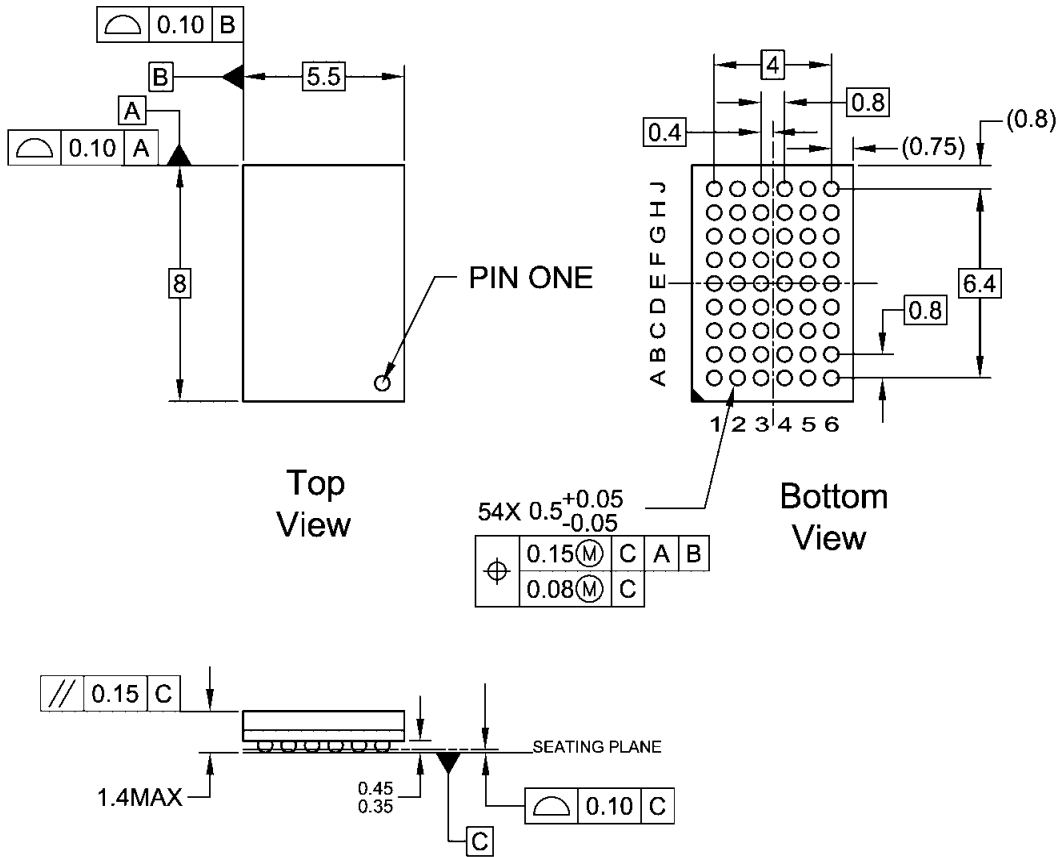

NOTES:

- A. THIS PACKAGE CONFORMS TO JEDEC M0-205
- B. ALL DIMENSIONS IN MILLIMETERS
- C. LAND PATTERN RECOMMENDATION: NSMD (Non Solder Mask Defined)
.35MM DIA PADS WITH A SOLDERMASK OPENING OF .45MM CONCENTRIC TO PADS
- D. DRAWING CONFORMS TO ASME Y14.5M-1994

BGA54ArevD

**Figure 1. 54-Ball Fine-Pitch Ball Grid Array (FBGA), JEDEC M0-205, 5.5mm Wide
Package Number BGA54A
(Preliminary)**

Physical Dimensions (Continued)

Dimensions are in inches (millimeters) unless otherwise noted.

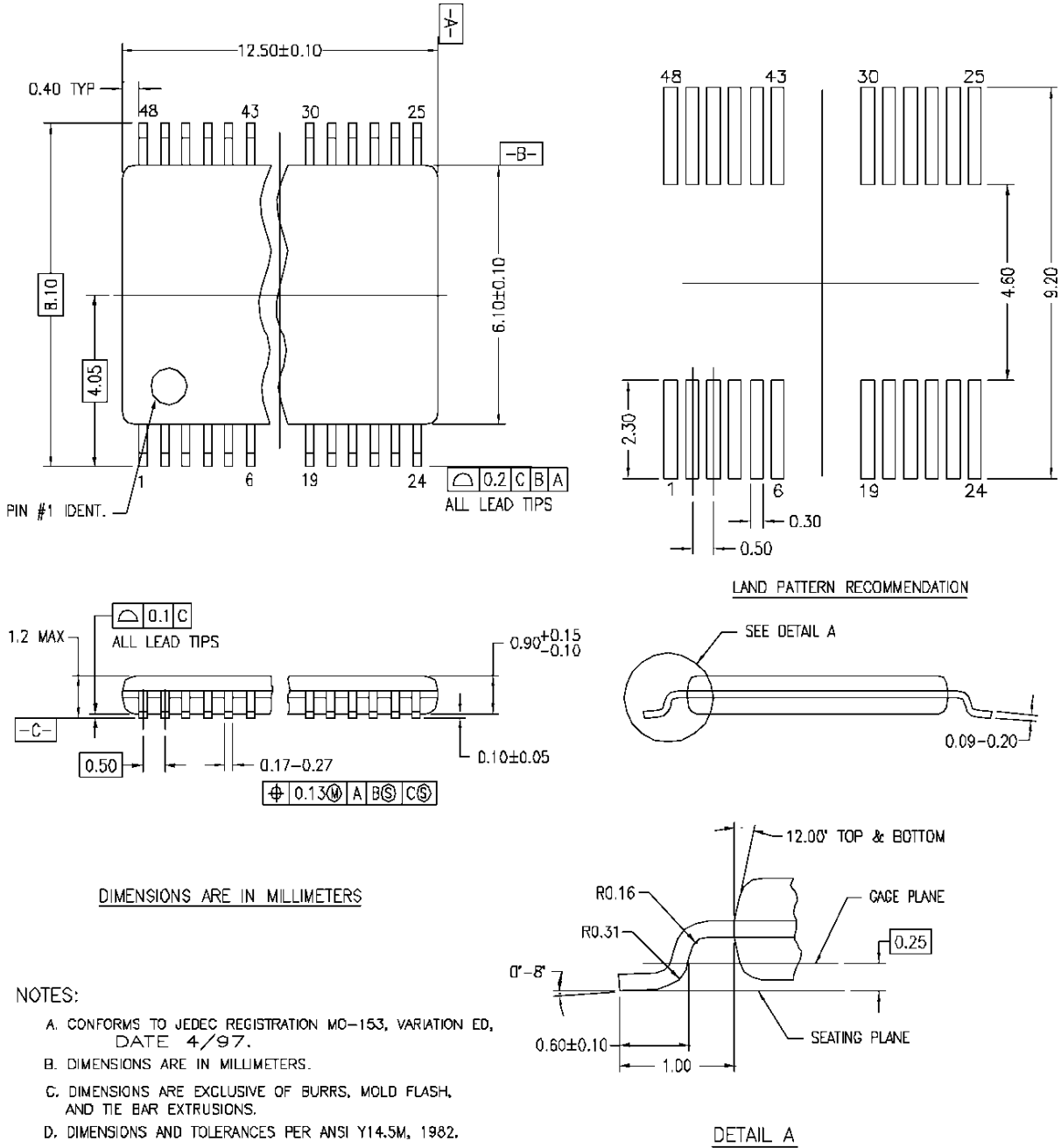

NOTES:

- A. CONFORMS TO JEDEC REGISTRATION MO-153, VARIATION ED, DATE 4/97.
- B. DIMENSIONS ARE IN MILLIMETERS.
- C. DIMENSIONS ARE EXCLUSIVE OF BURRS, MOLD FLASH, AND TIE BAR EXTRUSIONS.
- D. DIMENSIONS AND TOLERANCES PER ANSI Y14.5M, 1982.

MTD48REVC

Figure 3. 48-Lead Thin Shrink Small Outline Package (TSSOP), JEDEC MO-153, 6.1mm Wide Package Number MDT48



TRADEMARKS

The following are registered and unregistered trademarks and service marks Fairchild Semiconductor owns or is authorized to use and is not intended to be an exhaustive list of all such trademarks.

ACEX®	Green FPS™	Power247®	SuperSOT™-8
Build it Now™	Green FPS™ e-Series™	POWEREDGE®	SyncFET™
CorePLUS™	GTO™	Power-SPM™	The Power Franchise®
CROSSVOLT™	i-Lo™	PowerTrench®	the power franchise
CTL™	IntelliMAX™	Programmable Active Droop™	TinyBoost™
Current Transfer Logic™	ISOPLANAR™	QFET®	TinyBuck™
EcoSPARK®	MegaBuck™	QS™	TinyLogic®
F ®	MICROCOUPLER™	QT Optoelectronics™	TINYOPTO™
Fairchild®	MicroFET™	Quiet Series™	TinyPower™
Fairchild Semiconductor®	MicroPak™	RapidConfigure™	TinyPWM™
FACT Quiet Series™	Motion-SPM™	SMART START™	TinyWire™
FACT®	OPTOLOGIC®	SPM®	μSerDes™
FAST®	OPTOPLANAR®	STEALTH™	UHC®
FastvCore™	 ®	SuperFET™	UniFET™
FPS™	PDP-SPM™	SuperSOT™-3	VCX™
FRFET®	Power220®	SuperSOT™-6	
Global Power Resource SM			

DISCLAIMER

FAIRCHILD SEMICONDUCTOR RESERVES THE RIGHT TO MAKE CHANGES WITHOUT FURTHER NOTICE TO ANY PRODUCTS HEREIN TO IMPROVE RELIABILITY, FUNCTION, OR DESIGN. FAIRCHILD DOES NOT ASSUME ANY LIABILITY ARISING OUT OF THE APPLICATION OR USE OF ANY PRODUCT OR CIRCUIT DESCRIBED HEREIN; NEITHER DOES IT CONVEY ANY LICENSE UNDER ITS PATENT RIGHTS, NOR THE RIGHTS OF OTHERS. THESE SPECIFICATIONS DO NOT EXPAND THE TERMS OF FAIRCHILD'S WORLDWIDE TERMS AND CONDITIONS, SPECIFICALLY THE WARRANTY THEREIN, WHICH COVERS THESE PRODUCTS.

LIFE SUPPORT POLICY

FAIRCHILD'S PRODUCTS ARE NOT AUTHORIZED FOR USE AS CRITICAL COMPONENTS IN LIFE SUPPORT DEVICES OR SYSTEMS WITHOUT THE EXPRESS WRITTEN APPROVAL OF FAIRCHILD SEMICONDUCTOR CORPORATION.

As used herein:

- Life support devices or systems are devices or systems which, (a) are intended for surgical implant into the body, or (b) support or sustain life, and (c) whose failure to perform when properly used in accordance with instructions for use provided in the labeling, can be reasonably expected to result in significant injury to the user.
- A critical component is any component of a life support device or system whose failure to perform can be reasonably expected to cause the failure of the life support device or system, or to affect its safety or effectiveness.

PRODUCT STATUS DEFINITIONS

Definition of Terms

Datasheet Identification	Product Status	Definition
Advance Information	Formative or In Design	This datasheet contains the design specifications for product development. Specifications may change in any manner without notice.
Preliminary	First Production	This datasheet contains preliminary data; supplementary data will be published at a later date. Fairchild Semiconductor reserves the right to make changes at any time without notice to improve design.
No Identification Needed	Full Production	This datasheet contains final specifications. Fairchild Semiconductor reserves the right to make changes at any time without notice to improve design.
Obsolete	Not In Production	This datasheet contains specifications on a product that has been discontinued by Fairchild semiconductor. The datasheet is printed for reference information only.

Rev. 130