

Not Recommended for New Designs

This product was manufactured for Maxim by an outside wafer foundry using a process that is no longer available. It is not recommended for new designs. The data sheet remains available for existing users.

A Maxim replacement or an industry second-source may be available. Please see the QuickView data sheet for this part or contact technical support for assistance.

For further information, [contact Maxim's Applications Tech Support](#).



Dual/Quad Precision Op Amps

MXL1013/MXL1014

General Description

The Maxim MXL1013 is a precision dual op amp that upgrades the performance of popular devices such as the MC1458/MC1558, LM158 and OP221. The Maxim MXL1014 is a precision quad op amp that directly upgrades designs in the industry-standard 14-pin DIP configuration and has specifications similar to the LT1013. The MXL1013 and MXL1014 are pin compatible with industry standards such as the LT1013 and LT1014.

Precision specifications include: 40µV offset voltage, 0.3µV/°C drift (TCV_{OS}), 117dB CMRR, and 120dB PSRR. While supply current is typically only 350µA per amplifier, the outputs can source and sink more than 20mA.

Both the MXL1013 and the MXL1014 can be operated from a single +5V power supply. The input voltage range includes ground and the outputs swing to within a few millivolts of ground.

Applications

- Battery-Powered Precision Instrumentation
- Strain-Gauge Signal Conditioners
- Thermocouple Amplifiers
- Instrumentation Amplifiers
- 4mA to 20mA Current-Loop Transmitters
- Multiple-Limit Threshold Detection
- Active Filters
- Multiple Gain Blocks

Features

- ◆ **Single-Supply Operation**
Input Voltage Range Extends to Ground
Output Swings to Ground while Sinking Current
- ◆ **150µV Max Offset Voltage**
- ◆ **Low Drift: 2µV/°C Max**
- ◆ **0.8nA Max Offset Current**
- ◆ **Guaranteed High Gain**
5mA Load Current: 1.5 Million Min
17mA Load Current: 0.8 Million Min
- ◆ **500µA Max Supply Current per Amplifier**
- ◆ **Low Voltage Noise: 0.1Hz to 10Hz, 0.55µV_{p-p}**
- ◆ **Lower Current Noise than OP07: 0.07 pA/√Hz**

Ordering Information

PART	TEMP. RANGE	PIN-PACKAGE
MXL1013CN8	0°C to +70°C	8 Plastic DIP
MXL1013DN8	0°C to +70°C	8 Plastic DIP
MXL1013DS8	0°C to +70°C	8 SO
MXL1013DC/D	0°C to +70°C	Dice*
MXL1013IN8	-40°C to +85°C	8 Plastic DIP
MXL1013IS8	-40°C to +85°C	8 SO
MXL1013AMJ8	-55°C to +125°C	8 CERDIP**
MXL1013MJ8	-55°C to +125°C	8 CERDIP**

Ordering Information continued on last page.

* Dice are specified at T_A = +25°C, D.C. parameters only.

** Contact factory for availability and processing to MIL-STD-883.

Pin Configurations

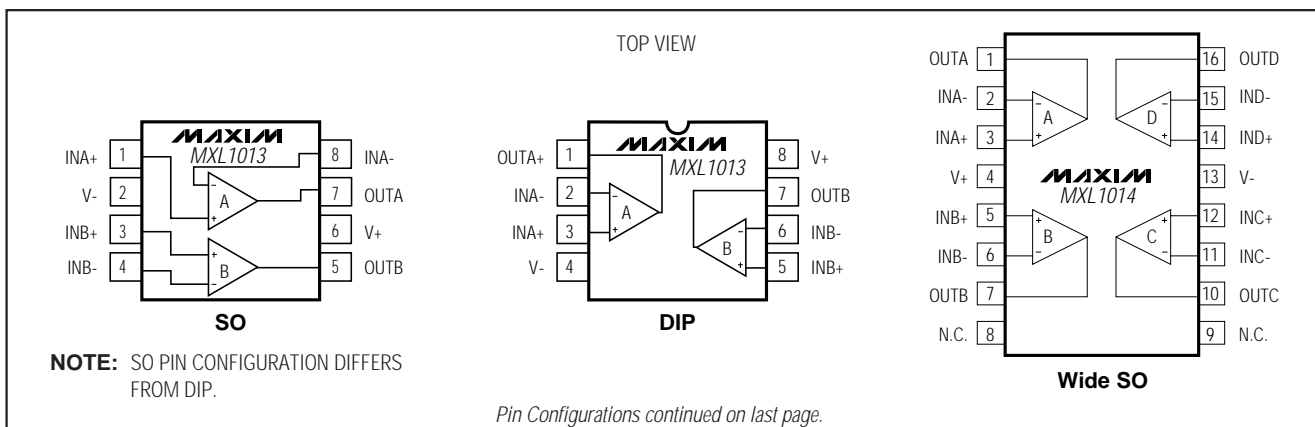

Dual/Quad Precision Op Amps

ABSOLUTE MAXIMUM RATINGS

Supply Voltage.....	±22V	14-Pin CERDIP (derate 9.09mW/°C above +70°C).....	727mW
Input Voltage.....	Equal to Positive Supply Voltage	16-Pin Wide SO (derate 9.52mW/°C above +70°C).....	762mW
5V Below Negative Supply Voltage	Operating Temperature Ranges:	
Output Short-Circuit Duration.....	Continuous	MXL1013/MXL1014C_.....	0°C to +70°C
Differential Input Voltage.....	±30V	MXL1013/MXL1014I_.....	-40°C to +85°C
Continuous Power Dissipation (T _A = +70°C)		MXL1013/MXL1014AM_M_.....	-55°C to +125°C
8-Pin Plastic DIP (derate 9.09mW/°C above +70°C).....	727mW	Storage Temperature Range.....	-65°C to +150°C
8-Pin SO (derate 5.88mW/°C above +70°C).....	471mW	Lead Temperature (soldering, 10sec).....	+300°C
8-Pin CERDIP (derate 8.00mW/°C above +70°C).....	640mW		
14-Pin Plastic DIP (derate 10.00mW/°C above +70°C).....	800mW		

Stresses beyond those listed under "Absolute Maximum Ratings" may cause permanent damage to the device. These are stress ratings only, and functional operation of the device at these or any other conditions beyond those indicated in the operational sections of the specifications is not implied. Exposure to absolute maximum rating conditions for extended periods may affect device reliability.

ELECTRICAL CHARACTERISTICS (Note 1)

(V_S = ±15V, V_{CM} = 0V, T_A = +25°C, unless otherwise noted.)

PARAMETER	SYMBOL	CONDITIONS	MXL1013AM MXL1014AM			MXL1013C/D/I/M MXL1014C/D/I/M			UNITS
			MIN	TYP	MAX	MIN	TYP	MAX	
Input Offset Voltage	V _{OS}	MXL1013		40	150		60	300	μV
		MXL1014		50	180		60	300	
		MXL101_D/I					200	800	
Long-Term Input Offset Voltage Stability				0.4			0.5		μV/Mo.
Input Offset Current	I _{OS}			0.15	0.80		0.2	1.5	nA
Input Bias Current	I _B			12	20		15	30	nA
Input Noise Voltage	e _n	0.1Hz to 10Hz		0.55			0.55		μV _{p-p}
Input Noise-Voltage Density	e _n	f _O = 10Hz		24			24		nV/√Hz
		f _O = 1000Hz		22			22		
Input Noise-Current Density	i _n	f _O = 10Hz		0.07			0.07		pA/√Hz
Input Resistance (Note 2)		Differential	100	400		70	300		MΩ
		Common mode		5			4		GΩ
Large-Signal Voltage Gain	A _{VOL}	V _O = ±10V, R _L = 2kΩ	1.5	8.0		1.2	7.0		V/μV
		V _O = ±10V, R _L = 600Ω	0.8	2.5		0.5	2.0		
Input Voltage Range			+13.5	+13.8		+13.5	+13.8		V
			-15.0	-15.3		-15.0	-15.3		
Common-Mode Rejection Ratio	CMRR	V _{CM} = +13.5V, -15.0V	100	117		97	114		dB

Dual/Quad Precision Op Amps

MXL1013/MXL1014

ELECTRICAL CHARACTERISTICS (continued) (Note 1)

($V_S = \pm 15V$, $V_{CM} = 0V$, $T_A = +25^\circ C$, unless otherwise noted.)

PARAMETER	SYMBOL	CONDITIONS	MXL1013AM MXL1014AM			MXL1013C/D/I/M MXL1014C/D/I/M			UNITS
			MIN	TYP	MAX	MIN	TYP	MAX	
Power-Supply Rejection Ratio	PSRR	$V_S = \pm 2V$ to $\pm 18V$	103	120		100	117		dB
Channel Separation		$V_O = \pm 10V$, $R_L = 2k\Omega$	123	140		120	137		dB
Output Voltage Swing	V_{OUT}	$R_L = 2k\Omega$	± 13	± 14		± 12.5	± 14		V
Slew Rate			0.2	0.4		0.2	0.4		V/ μs
Supply Current	I_S	Per amplifier		0.35	0.50		0.35	0.55	mA

Note 1: When amplifier is sinking current at the output a minimum load of $1k\Omega$ is recommended.

Note 2: Guaranteed by design.

ELECTRICAL CHARACTERISTICS (Note 1)

($V_{S+} = +5V$, $V_{S-} = 0V$, $V_{OUT} = +1.4V$, $V_{CM} = 0V$, $T_A = +25^\circ C$, unless otherwise noted.)

PARAMETER	SYMBOL	CONDITIONS	MXL1013AM MXL1014AM			MXL1013C/D/I/M MXL1014C/D/I/M			UNITS
			MIN	TYP	MAX	MIN	TYP	MAX	
Input Offset Voltage	V_{OS}	MXL1013		60	250		90	450	μV
		MXL1014		70	280		90	450	
		MXL101_D/I					250	950	
Input Offset Current	I_{OS}			0.2	1.3		0.3	2.0	nA
Input Bias Current	I_B			15	35		18	50	nA
Large-Signal Voltage Gain	A_{VOL}	$V_O = 5mV$ to $4V$, $R_L = 500\Omega$		1.0			1.0		V/ μV
Input Voltage Range			+3.5	+3.8		+3.5	+3.8		V
			0	-0.3		0	-0.3		
Output Voltage Swing	V_{OUT}	Output low, no load		15	25		15	25	mV
		Output low, 600Ω to ground		5	10		5	10	
		Output low, $I_{SINK} = 1mA$		220	350		220	350	
		Output high, no load		4.0	4.4		4.0	4.4	V
		Output high, 600Ω to ground		3.4	4.0		3.4	4.0	
Supply Current	I_S	Per amplifier		0.31	0.45		0.32	0.50	mA

Dual/Quad Precision Op Amps

MXL1013/MXL1014

ELECTRICAL CHARACTERISTICS (Note 1)

($V_S = \pm 15V$, $V_{CM} = 0V$, $T_A = -40^\circ C$ to $+85^\circ C$ for MXL1013I and MXL1014I, $T_A = 0^\circ C$ to $+70^\circ C$ for MXL1013C/D and MXL1014C/D, unless otherwise noted.)

PARAMETER	SYMBOL	CONDITIONS	MXL1013C/D/I MXL1014C/D/I			UNITS	
			MIN	TYP	MAX		
Input Offset Voltage	V_{OS}	MXL101_C		80	400	μV	
		MXL101_D/I		230	1000		
		MXL101_C: $V_S = 5V, 0V, V_O = 1.4V$		110	570		
		MXL101_D/I: $V_S = 5V, 0V; V_O = 1.4V$		280	1200		
Input Offset-Voltage Drift	TCV_{OS}	(Note 2)		0.4	2.5	$\mu V/^\circ C$	
		MXL101_D/I (Note 2)		0.7	5.0		
Input Offset Current	I_{OS}			0.3	2.8	nA	
		$V_S = 5V, 0V; V_O = 1.4V$		0.5	6.0		
Input Bias Current	I_B			16	38	nA	
		$V_S = 5V, 0V; V_O = 1.4V$		24	90		
Large-Signal Voltage Gain	A_{VOL}	$V_O = \pm 10V, R_L = 2k\Omega$	0.7	4.0		V/ μV	
Common-Mode Rejection Ratio	CMRR	$V_{CM} = +13.0V, -15.0V$	94	113		dB	
Power-Supply Rejection Ratio	PSRR	$V_S = \pm 2V$ to $\pm 18V$	97	116		dB	
Output Voltage Swing	V_{OUT}	$R_L = 2k\Omega$	± 12.0	± 13.9		V	
		$V_S = 5V, 0V,$ $R_L = 600\Omega$	Output low	6	13		mV
			Output high	3.2	3.9		V
Supply Current per Amplifier	I_S			0.37	0.60	mA	
		$V_S = 5V, 0V, V_O = 1.4V$		0.34	0.55		

Dual/Quad Precision Op Amps

MXL1013/MXL1014

ELECTRICAL CHARACTERISTICS (Note 1)

($V_S = \pm 15V$, $V_{CM} = 0V$, $T_A = -55^\circ C$ to $+125^\circ C$, unless otherwise noted.)

PARAMETER	SYMBOL	CONDITIONS		MXL1013AM			MXL1014AM			MXL1013M MXL1014M			UNITS	
				MIN	TYP	MAX	MIN	TYP	MAX	MIN	TYP	MAX		
Input Offset Voltage	V_{OS}	$V_S = 5V, 0V, V_O = 1.4V$		$T_A = -55^\circ C$ to $+100^\circ C$ (Note 3)		80	300		90	350		110	550	μV
						80	450		90	480		100	750	
				$T_A = +125^\circ C, V_{CM} = 0.1V$		120	450		150	480		200	750	
				$T_A = +125^\circ C, V_{CM} = 0V$		250	900		300	960		400	1500	
Input Offset-Voltage Drift	TCV_{OS}	(Note 2)		0.4	2.0		0.4	2.0		0.5	2.5	$\mu V/^\circ C$		
Input Offset Current	I_{OS}	$V_S = 5V, 0V; V_O = 1.4V$		0.3	2.5		0.3	2.8		0.4	5.0	nA		
				0.6	6.0		0.7	7.0		0.9	10.0			
Input Bias Current	I_B	$V_S = 5V, 0V; V_O = 1.4V$		15	30		15	30		18	45	nA		
				20	80		25	90		28	120			
Large-Signal Voltage Gain	A_{VOL}	$V_O = \pm 10V, R_L = 2k\Omega$		0.5	2.0		0.4	2.0		0.25	2.0	$V/\mu V$		
Common-Mode Rejection Ratio	CMRR	$V_{CM} = +13.0V, -14.9V$		97	114		96	114		94	113	dB		
Power-Supply Rejection Ratio	PSRR	$V_S = \pm 2V$ to $\pm 18V$		100	117		100	117		97	116	dB		
Output Voltage Swing	V_{OUT}	$R_L = 2k\Omega$		± 12.0	± 13.8		± 12.0	± 13.8		± 11.5	± 13.8	V		
		$V_S = 5V, 0V, R_L = 600\Omega$ to ground	Output low	6	15		6	15		6	18	mV		
			Output high	3.2	3.8		3.2	3.8		3.1	3.8	V		
Supply Current per Amplifier	I_S	$V_S = 5V, 0V; V_O = 1.4V$		0.38	0.60		0.38	0.60		0.38	0.70	mA		
				0.34	0.55		0.34	0.55		0.34	0.65			

Note 1: When amplifier is sinking current at the output, a minimum load of $1k\Omega$ is recommended.

Note 2: Guaranteed by design.

Note 3: This parameter is guaranteed by design and is not tested.

Dual/Quad Precision Op Amps

Typical Operating Characteristics

($T_A = +25^\circ\text{C}$, unless otherwise noted.)

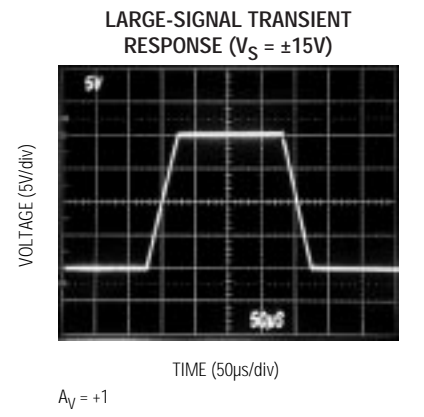
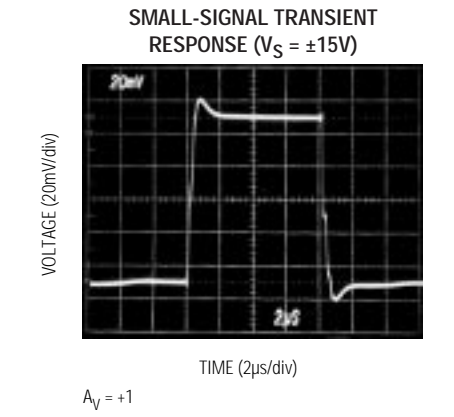
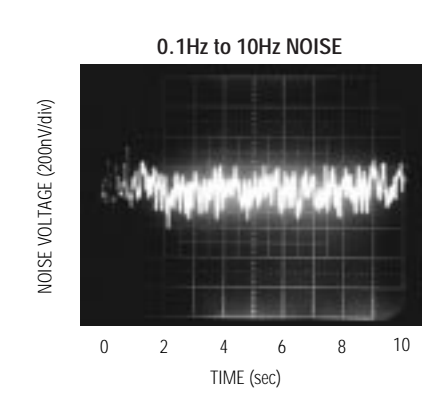
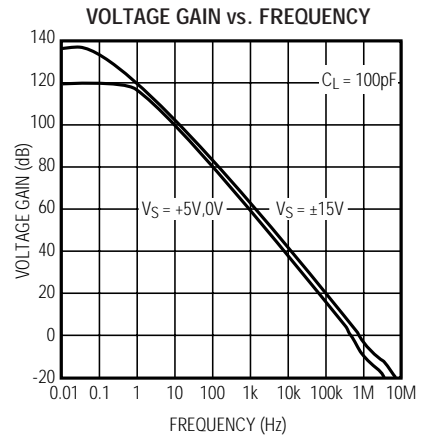
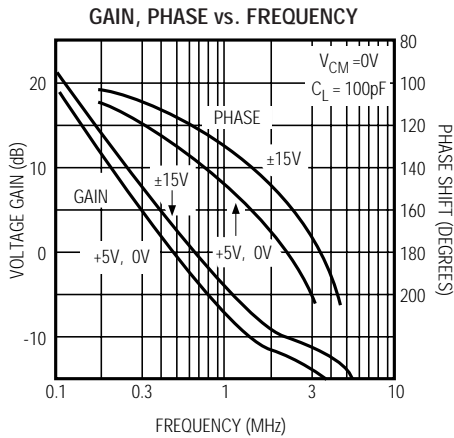
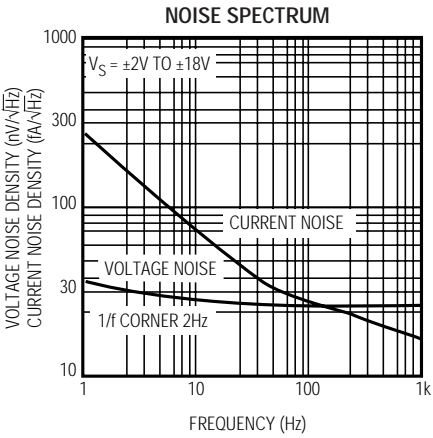
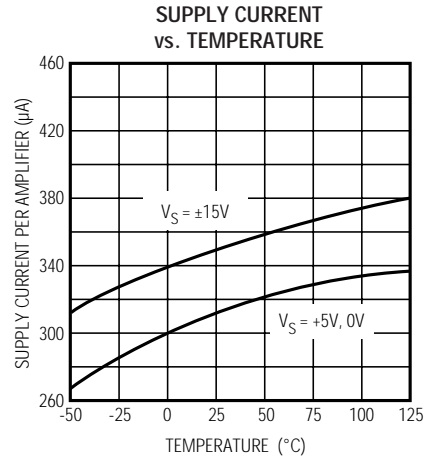
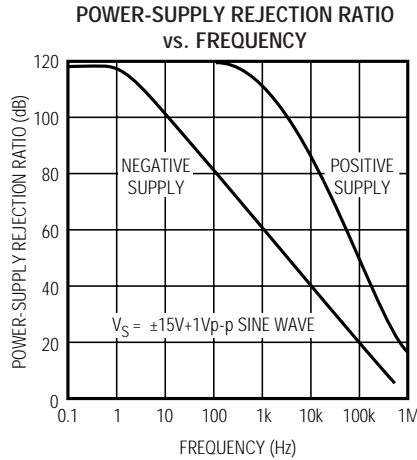
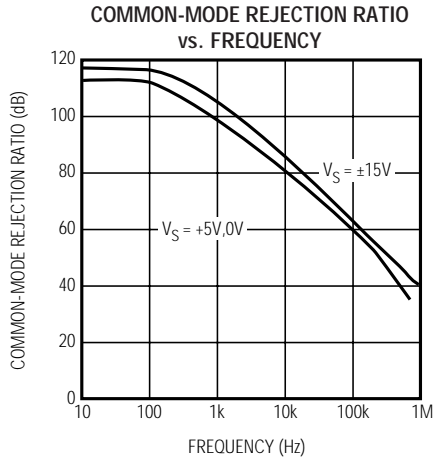

Dual/Quad Precision Op Amps

Typical Operating Characteristics (continued)

MXL1013/MXL1014

SMALL-SIGNAL TRANSIENT RESPONSE ($V_S = 5V, 0V$)

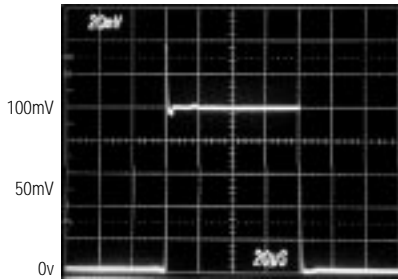

TIME (20µs/div)

$A_V = +1$
 $R_L = 600\Omega$ to GND

LARGE-SIGNAL TRANSIENT RESPONSE ($V_S = 5V, 0V$)

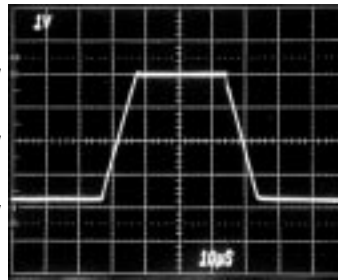

TIME (10µs/div)

$A_V = +1$
 $R_L = 4.7k\Omega$ to 5V

LARGE-SIGNAL TRANSIENT RESPONSE ($V_S = 5V, 0V$)

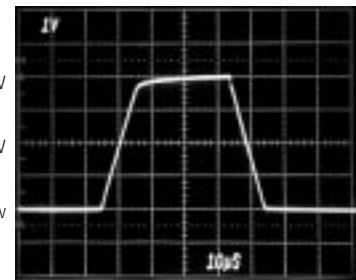

TIME (10µs/div)

$A_V = +1$
No load

Pin Configurations (continued)

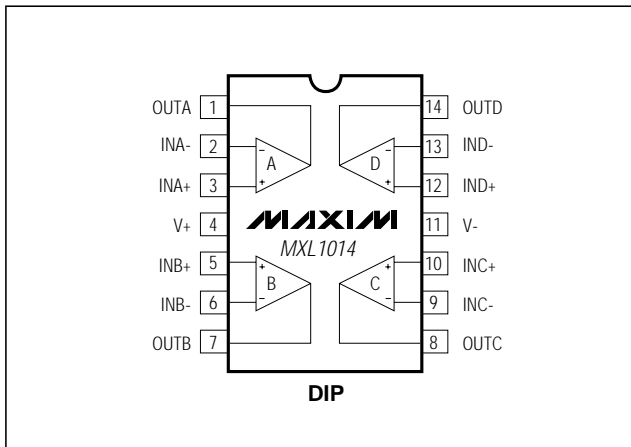

Chip Topography

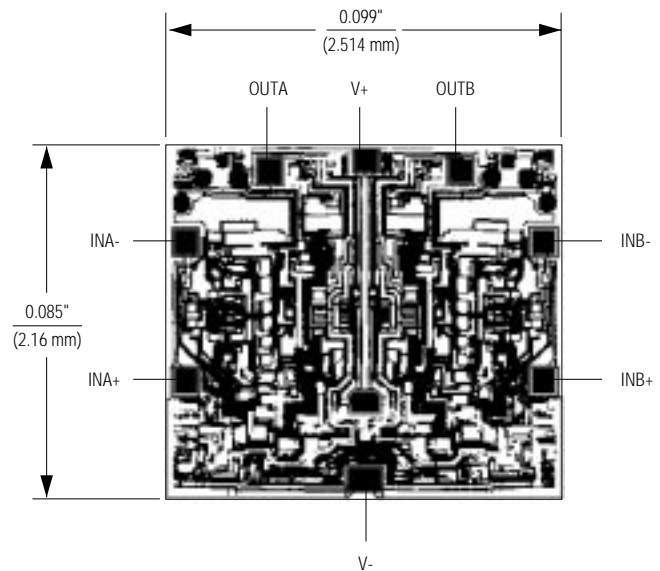

Ordering Information (continued)

PART	TEMP. RANGE	PIN-PACKAGE
MXL1014CN	0°C to +70°C	14 Plastic DIP
MXL1014DS	0°C to +70°C	16 Wide SO
MXL1014DN	0°C to +70°C	14 Plastic DIP
MXL1014IN	-40°C to +85°C	14 Plastic DIP
MXL1014IS	-40°C to +85°C	16 Wide SO
MXL1014AMJ	-55°C to +125°C	14 CERDIP**
MXL1014MJ	-55°C to +125°C	14 CERDIP**

**Contact factory for availability and processing to MIL-STD-883.

Dual/Quad Precision Op Amps

Package Information

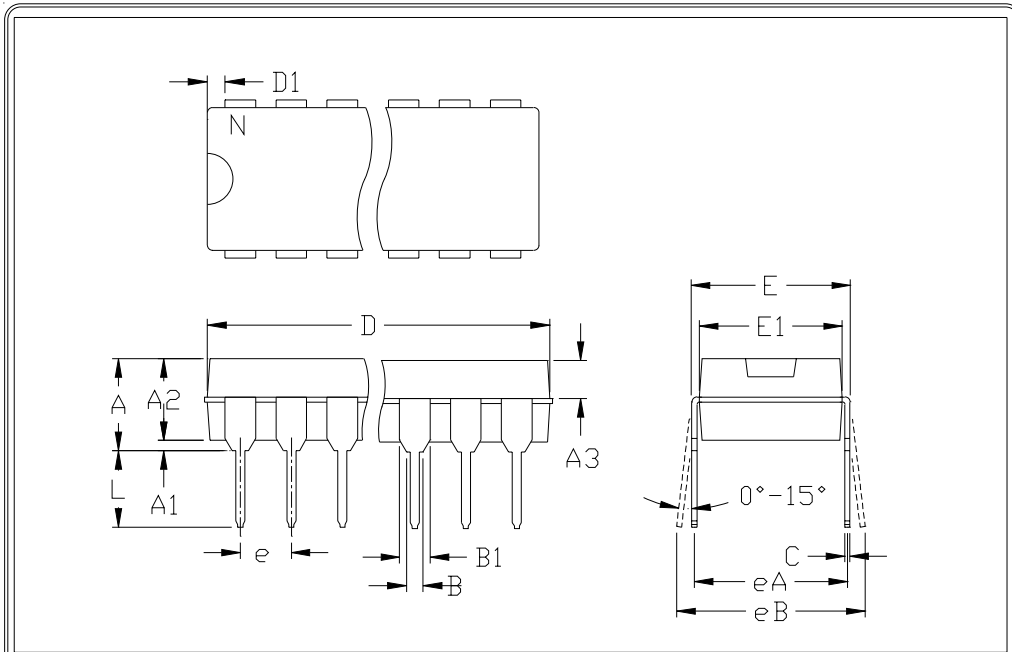

	INCHES		MILLIMETERS	
	MIN	MAX	MIN	MAX
A	---	0.200	---	5.08
A1	0.015	---	0.38	---
A2	0.125	0.175	3.18	4.45
A3	0.055	0.080	1.40	2.03
B	0.016	0.022	0.41	0.56
B1	0.045	0.065	1.14	1.65
C	0.008	0.012	0.20	0.30
D1	0.005	0.080	0.13	2.03
E	0.300	0.325	7.62	8.26
E1	0.240	0.310	6.10	7.87
e	0.100	---	2.54	---
eA	0.300	---	7.62	---
eB	---	0.400	---	10.16
L	0.115	0.150	2.92	3.81

	INCHES		MILLIMETERS		N	MS001
	MIN	MAX	MIN	MAX		
D	0.348	0.390	8.84	9.91	8	AB
D	0.735	0.765	18.67	19.43	14	AC
D	0.745	0.765	18.92	19.43	16	AA
D	0.885	0.915	22.48	23.24	18	AD
D	1.015	1.045	25.78	26.54	20	AE
D	1.14	1.265	28.96	32.13	24	AF
D	1.360	1.380	34.54	35.05	28	*5

- NOTES:
1. D&E DO NOT INCLUDE MOLD FLASH
 2. MOLD FLASH OR PROTRUSIONS NOT TO EXCEED .15mm (.006")
 3. CONTROLLING DIMENSION: MILLIMETER
 4. MEETS JEDEC MS001-XX AS SHOWN IN ABOVE TABLE
 5. SIMILAR TO JEDEC MO-058AB
 6. N = NUMBER OF PINS



PACKAGE FAMILY OUTLINE: PDIP .300"



21-0043 A
DOCUMENT CONTROL NUMBER REV

Maxim cannot assume responsibility for use of any circuitry other than circuitry entirely embodied in a Maxim product. No circuit patent licenses are implied. Maxim reserves the right to change the circuitry and specifications without notice at any time.

8 _____ Maxim Integrated Products, 120 San Gabriel Drive, Sunnyvale, CA 94086 408-737-7600