

National Semiconductor is now part of  
Texas Instruments.

Search <http://www.ti.com/> for the latest technical  
information and details on our current products and services.

# LMV710/LMV711/LMV715

## Low Power, RRIO Operational Amplifiers with High Output Current Drive and Shutdown Option

### General Description

The LMV710/LMV711/LMV715 are BiCMOS operational amplifiers with a CMOS input stage. These devices have greater than RR input common mode voltage range, rail-to-rail output and high output current drive. They offer a bandwidth of 5 MHz and a slew rate of 5 V/μs.

On the LMV711/LMV715, a separate shutdown pin can be used to disable the device and reduces the supply current to 0.2 μA (typical). They also feature a turn on time of less than 10 μs. It is an ideal solution for power sensitive applications, such as cellular phone, pager, palm computer, etc. In addition, once the LMV715 is in shutdown the output will be "Tri-stated".

The LMV710 is offered in the space saving 5-Pin SOT23 Tiny package. The LMV711/LMV715 are offered in the space saving 6-Pin SOT23 Tiny package.

The LMV710/LMV711/LMV715 are designed to meet the demands of low power, low cost, and small size required by cellular phones and similar battery powered portable electronics.

### Features

(For 5V supply, typical unless otherwise noted).

- Low offset voltage 3 mV, max
- Gain-bandwidth product 5 MHz, typ
- Slew rate 5 V/μs, typ
- Space saving packages 5-Pin and 6-Pin SOT23
- Turn on time from shutdown <10 μs
- Industrial temperature range -40°C to +85°C
- Supply current in shutdown mode 0.2 μA, typ
- Guaranteed 2.7V and 5V performance
- Unity gain stable
- Rail-to-rail input and output
- Capable of driving 600Ω load

### Applications

- Wireless phones
- GSM/TDMA/CDMA power amp control
- AGC, RF power detector
- Temperature compensation
- Wireless LAN
- Bluetooth
- HomeRF

### Typical Application

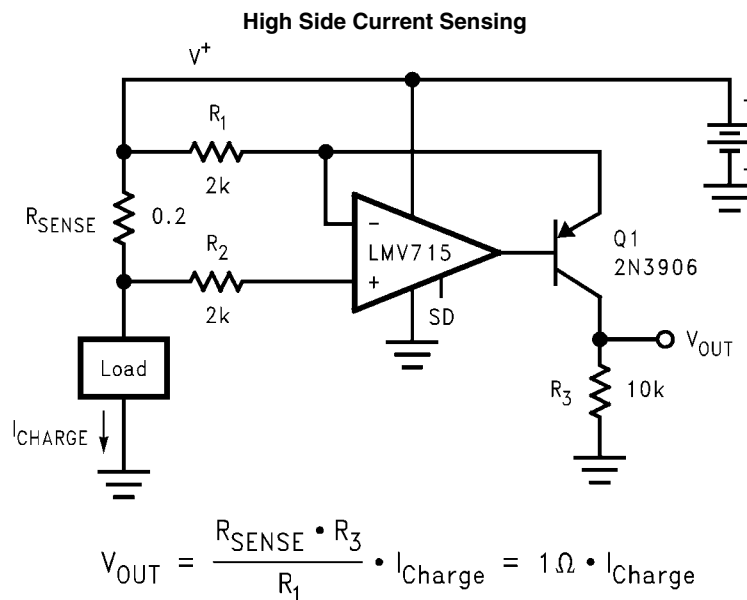

10132513

**Absolute Maximum Ratings** (Note 1)

If Military/Aerospace specified devices are required, please contact the National Semiconductor Sales Office/Distributors for availability and specifications.

ESD Tolerance (Note 2)	
Machine Model	100V
Human Body Model	2000V
Differential Input Voltage	± Supply Voltage
Voltage at Input/Output Pin	(V <sup>+</sup> ) + 0.4V (V <sup>-</sup> ) - 0.4V
Supply Voltage (V <sup>+</sup> - V <sup>-</sup> )	5.5V
Output Short Circuit to V <sup>+</sup>	(Note 3)
Output Short Circuit to V <sup>-</sup>	(Note 4)

Current at Input Pin	± 10 mA
Mounting Temp.	
Infrared or Convection (20 sec)	235°C
Storage Temperature Range	-65°C to 150°C
Junction Temperature (T <sub>JMAX</sub> )	150°C
(Note 5)	

**Operating Ratings** (Note 1)

Supply Voltage	2.7V to 5.0V
Temperature Range	-40°C to 85°C
Thermal Resistance (θ <sub>JA</sub> )	
MF05A Package, 5-Pin SOT23	265 °C/W
MF06A package, 6-Pin SOT23	265 °C/W

**2.7V Electrical Characteristics**

Unless otherwise specified, all limits guaranteed for T<sub>J</sub> = 25°C. V<sup>+</sup> = 2.7V, V<sup>-</sup> = 0V, V<sub>CM</sub> = 1.35V and R<sub>L</sub> > 1 MΩ. **Boldface** limits apply at the temperature extremes.

Symbol	Parameter	Condition	Typ (Note 6)	Limits (Note 7)	Units
V <sub>OS</sub>	Input Offset Voltage	V <sub>CM</sub> = 0.85V and V <sub>CM</sub> = 1.85V	0.4	3 <b>3.2</b>	mV max
I <sub>B</sub>	Input Bias Current		4		pA
CMRR	Common Mode Rejection Ratio	0 ≤ V <sub>CM</sub> ≤ 2.7V	75	50 <b>45</b>	dB min
PSRR	Power Supply Rejection Ratio	2.7V ≤ V <sup>+</sup> ≤ 5V, V <sub>CM</sub> = 0.85V	110	70 <b>68</b>	dB min
		2.7V ≤ V <sup>+</sup> ≤ 5V, V <sub>CM</sub> = 1.85V	95	70 <b>68</b>	dB min
V <sub>CM</sub>	Input Common-Mode Voltage Range	For CMRR ≥ 50 dB	-0.3	-0.2	V
			3	2.9	
I <sub>SC</sub>	Output Short Circuit Current	Sourcing V <sub>O</sub> = 0V	28	15 <b>12</b>	mA min
		Sinking V <sub>O</sub> = 2.7V	40	25 <b>22</b>	mA min
V <sub>O</sub>	Output Swing	R <sub>L</sub> = 10 kΩ to 1.35V	2.68	2.62 <b>2.60</b>	V min
			0.01	0.12 <b>0.15</b>	V max
		R <sub>L</sub> = 600Ω to 1.35V	2.55	2.52 <b>2.50</b>	V min
			0.05	0.23 <b>0.30</b>	V max
V <sub>O</sub> (SD)	Output Voltage Level in Shutdown Mode (LMV711 only)		50	200	mV
I <sub>O</sub> (SD)	Output Leakage Current in Shutdown Mode (LMV715 Only)		1		pA
C <sub>O</sub> (SD)	Output Capacitance in Shutdown Mode (LMV715 Only)		32		pF
I <sub>S</sub>	Supply Current	On Mode	1.22	1.7 <b>1.9</b>	mA max
		Shutdown Mode, V <sub>SD</sub> = 0V	0.002	10	μA

Symbol	Parameter	Condition	Typ (Note 6)	Limits (Note 7)	Units
A <sub>v</sub>	Large Signal Voltage	Sourcing R <sub>L</sub> = 10 kΩ V <sub>O</sub> = 1.35V to 2.3V	115	80 <b>76</b>	dB min
		Sinking R <sub>L</sub> = 10 kΩ V <sub>O</sub> = 0.4V to 1.35V	113	80 <b>76</b>	dB min
		Sourcing R <sub>L</sub> = 600Ω V <sub>O</sub> = 1.35V to 2.2V	110	80 <b>76</b>	dB min
		Sinking R <sub>L</sub> = 600Ω V <sub>O</sub> = 0.5V to 1.35V	100	80 <b>76</b>	dB min
SR	Slew Rate	(Note 8)	5		V/μs
GBWP	Gain-Bandwidth Product		5		MHz
φ <sub>m</sub>	Phase Margin		60		Deg
T <sub>ON</sub>	Turn-on Time from Shutdown		<10		μs
V <sub>SD</sub>	Shutdown Pin Voltage Range	On Mode	1.5 to 2.7	2.4 to 2.7	V
		Shutdown Mode	0 to 1	0 to 0.8	V
e <sub>n</sub>	Input-Referred Voltage Noise	f = 1 kHz	20		$\frac{nV}{\sqrt{Hz}}$

### 3.2V Electrical Characteristics

Unless otherwise specified, all limits guaranteed for T<sub>J</sub> = 25°C. V<sub>+</sub> = 3.2V, V<sub>-</sub> = 0V, V<sub>CM</sub> = 1.6V. **Boldface** limits apply at the temperature extremes.

Symbol	Parameter	Conditions	Typ (Note 6)	Limit (Note 7)	Units
V <sub>O</sub>	Output Swing	I <sub>O</sub> = 6.5 mA	3.0	2.95 <b>2.92</b>	V min
			0.01	0.18 <b>0.25</b>	V max

### 5V Electrical Characteristics

Unless otherwise specified, all limits guaranteed for T<sub>J</sub> = 25°C. V<sub>+</sub> = 5V, V<sub>-</sub> = 0V, V<sub>CM</sub> = 2.5V, and R<sub>L</sub> > 1 MΩ. **Boldface** limits apply at the temperature extremes.

Symbol	Parameter	Condition	Typ (Note 6)	Limits (Note 7)	Units
V <sub>OS</sub>	Input Offset Voltage	V <sub>CM</sub> = 0.85V and V <sub>CM</sub> = 1.85V	0.4	3 <b>3.2</b>	mV max
I <sub>B</sub>	Input Bias Current		4		pA
CMRR	Common Mode Rejection Ratio	0V ≤ V <sub>CM</sub> ≤ 5V	70	50 <b>48</b>	dB min
PSRR	Power Supply Rejection Ratio	2.7V ≤ V <sub>+</sub> ≤ 5V, V <sub>CM</sub> = 0.85V	110	70 <b>68</b>	dB min
		2.7V ≤ V <sub>+</sub> ≤ 5V, V <sub>CM</sub> = 1.85V	95	70 <b>68</b>	dB min
V <sub>CM</sub>	Input Common-Mode Voltage Range	For CMRR ≥ 50 dB	-0.3	-0.2	V
			5.3	5.2	

Symbol	Parameter	Condition	Typ (Note 6)	Limits (Note 7)	Units
$I_{sc}$	Output Short Circuit Current	Sourcing $V_O = 0V$	35	25 <b>21</b>	mA min
		Sinking $V_O = 5V$	40	25 <b>21</b>	mA min
$V_O$	Output Swing	$R_L = 10\text{ k}\Omega$ to 2.5V	4.98	4.92 <b>4.90</b>	V min
			0.01	0.12 <b>0.15</b>	V max
		$R_L = 600\Omega$ to 2.5V	4.85	4.82 <b>4.80</b>	V min
			0.05	0.23 <b>0.3</b>	V max
$V_O$ (SD)	Output Voltage Level in Shutdown Mode (LMV711 only)		50	200	mV
$I_O$ (SD)	Output Leakage Current in Shutdown Mode (LMV715 Only)		1		pA
$C_O$ (SD)	Output Capacitance in shutdown Mode (LMV715 Only)		32		pF
$I_S$	Supply Current	On Mode	1.17	1.7 <b>1.9</b>	mA max
		Shutdown Mode	0.2	10	$\mu$ A
$A_V$	Large Signal Voltage Gain	Sourcing $R_L = 10\text{ k}\Omega$ $V_O = 2.5V$ to 4.6V	123	80 <b>76</b>	dB min
		Sinking $R_L = 10\text{ k}\Omega$ $V_O = 0.4V$ to 2.5V	120	80 <b>76</b>	dB min
		Sourcing $R_L = 600\Omega$ $V_O = 2.5V$ to 4.5V	110	80 <b>76</b>	dB min
		Sinking $R_L = 600\Omega$ $V_O = 0.5V$ to 2.5V	118	80 <b>76</b>	dB min
SR	Slew Rate	(Note 8)	5		V/ $\mu$ s
GBWP	Gain-Bandwidth Product		5		MHz
$\phi_m$	Phase Margin		60		Deg
$T_{ON}$	Turn-on Time from Shutdown		<10		$\mu$ s
$V_{SD}$	Shutdown Pin Voltage Range	On Mode	2 to 5	2.4 to 5	V
		Shutdown Mode	0 to 1.5	0 to 0.8	
$e_n$	Input-Referred Voltage Noise	$f = 1\text{ kHz}$	20		$\frac{nV}{\sqrt{Hz}}$

**Note 1:** Absolute Maximum Ratings indicate limits beyond which damage to the device may occur. Operating Ratings indicate conditions for which the device is intended to be functional, but specific performance is not guaranteed. For guaranteed specifications and the test conditions, see the Electrical Characteristics.

**Note 2:** Human body model, 1.5 k $\Omega$  in series with 100 pF. Machine model, 0 $\Omega$  in series with 100 pF.

**Note 3:** Shorting circuit output to  $V^+$  will adversely affect reliability.

**Note 4:** Shorting circuit output to  $V^-$  will adversely affect reliability.

**Note 5:** The maximum power dissipation is a function of  $T_{J(MAX)}$ ,  $\theta_{JA}$ , and  $T_A$ . The maximum allowable power dissipation at any ambient temperature is  $P_D = (T_{J(MAX)} - T_A)/\theta_{JA}$ . All numbers apply for packages soldered directly into a PC board.

**Note 6:** Typical values represent the most likely parametric norm.

**Note 7:** All limits are guaranteed by testing or statistical analysis.

**Note 8:** Number specified is the slower of the positive and negative slew rates.

**Typical Performance Characteristics** Unless otherwise specified,  $V_S = +5V$ , single supply,  $T_A = 25^\circ C$ .

**Supply Current vs. Supply Voltage (On Mode)**

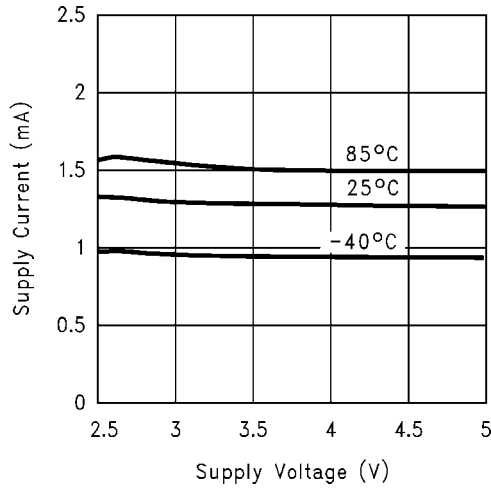

10132527

**LMV711/LMV715 Supply Current vs. Supply Voltage (Shutdown Mode)**

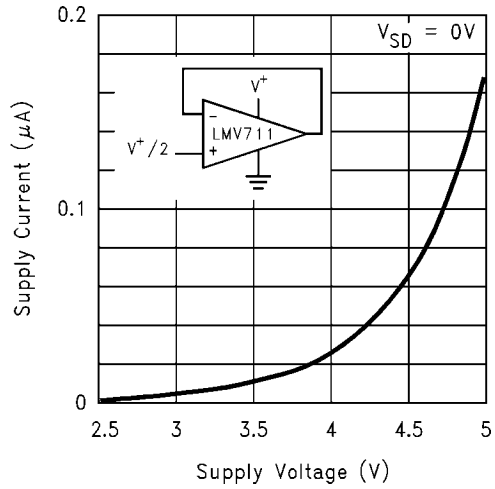

10132528

**Output Positive Swing vs. Supply Voltage**

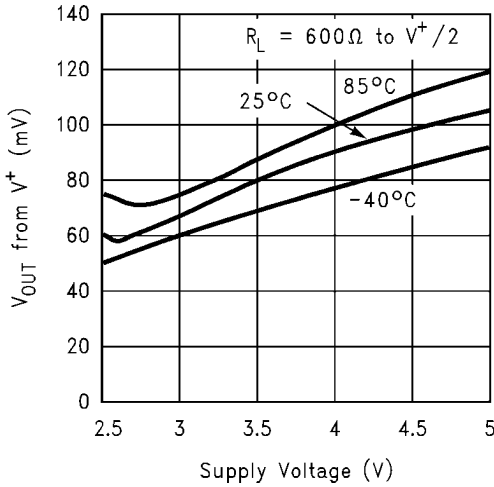

10132529

**Output Negative Swing vs. Supply Voltage**

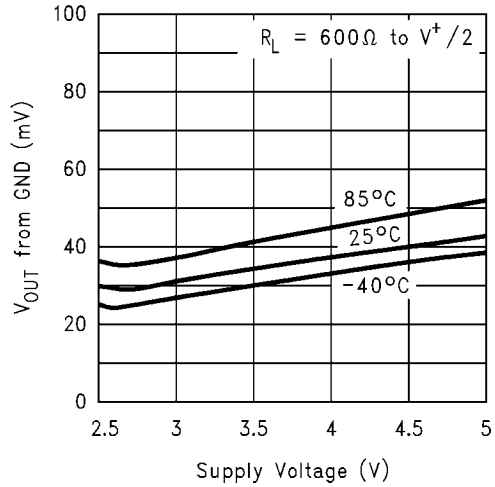

10132530

**Output Positive Swing vs. Supply Voltage**

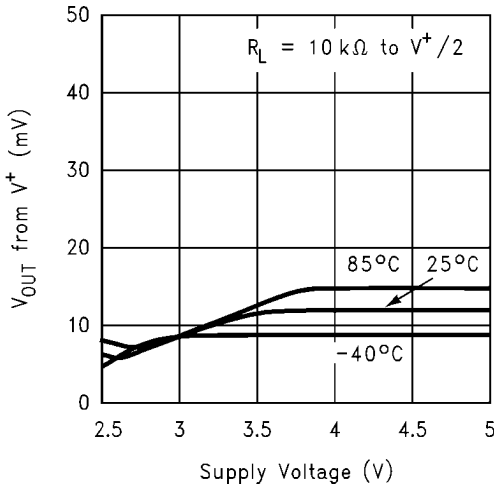

10132531

**Output Negative Swing vs. Supply Voltage**

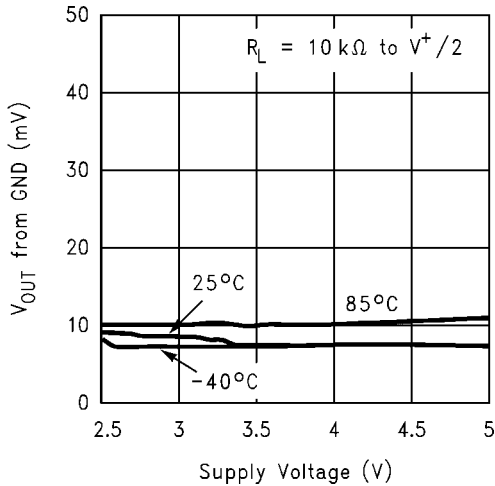

10132532

Output Positive Swing vs. Supply Voltage

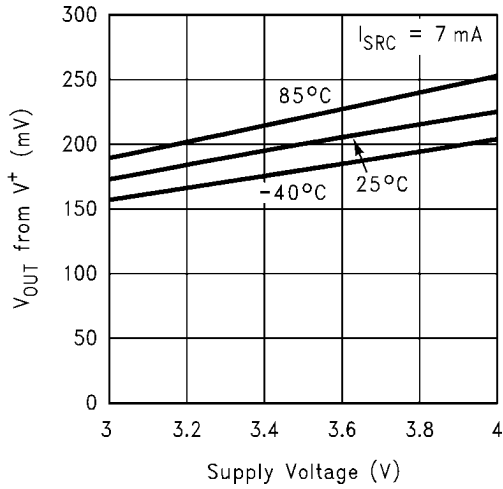

10132533

Output Negative Swing vs. Supply Voltage

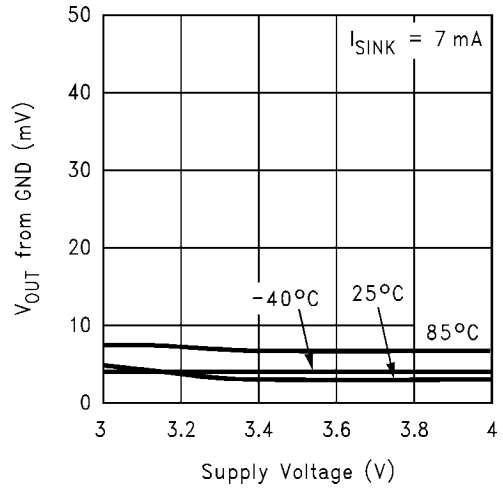

10132534

Input Voltage Noise vs. Frequency

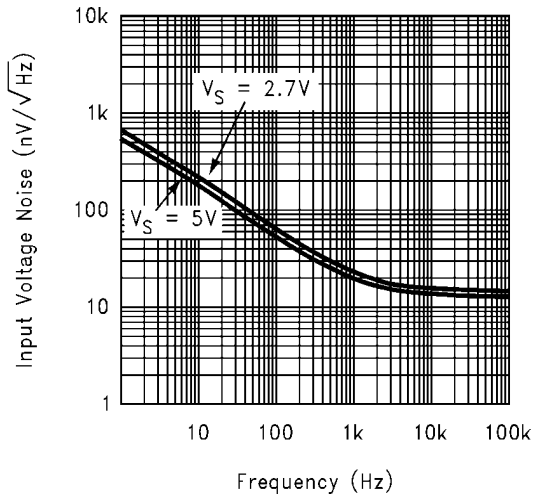

10132535

PSRR vs. Frequency

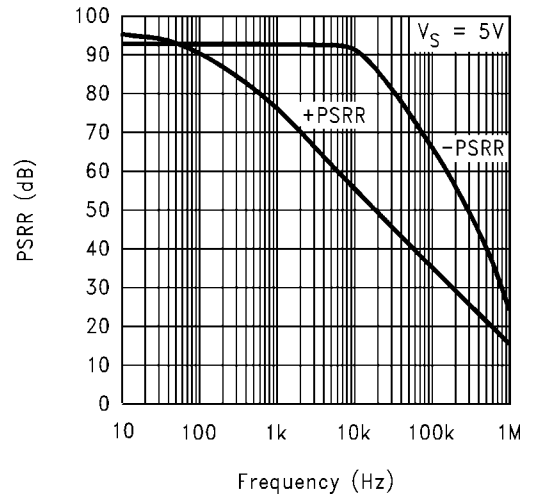

10132536

CMRR vs. Frequency

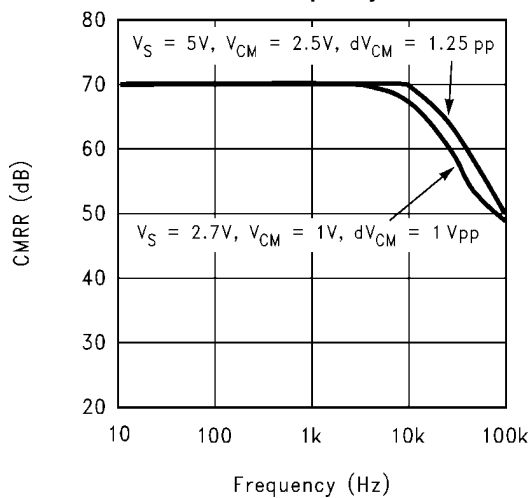

10132537

LMV711/LMV715 Turn On Characteristics

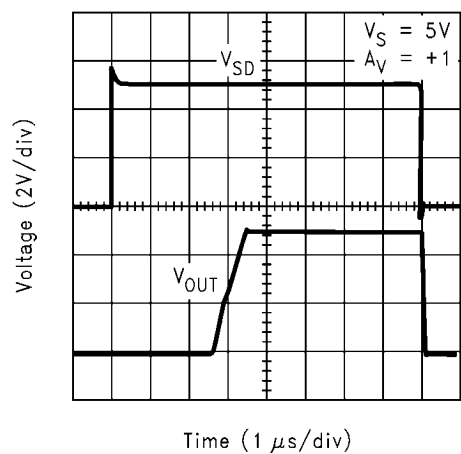

10132538

**Sourcing Current vs. Output Voltage**

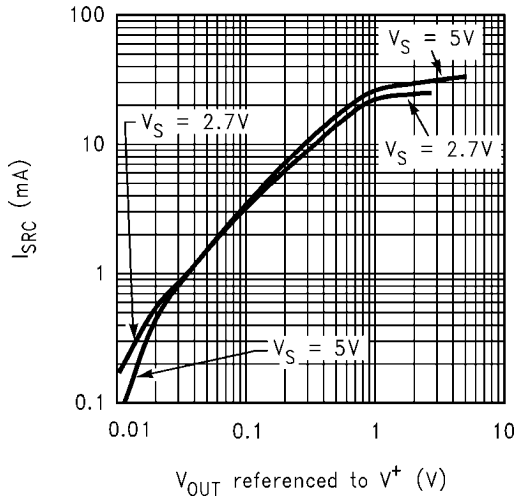

10132539

**Sinking Current vs. Output Voltage**

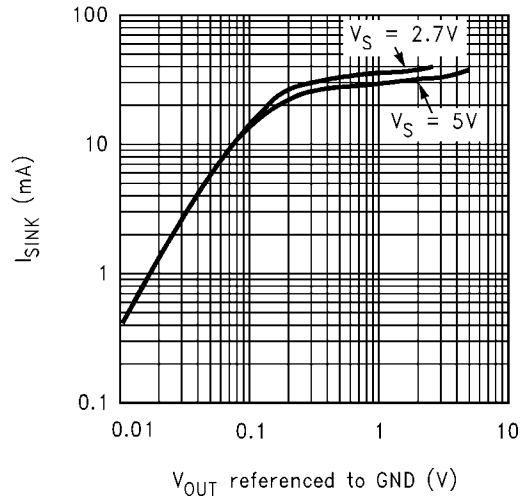

10132540

**THD+N vs. Frequency ( $V_S = 5V$ )**

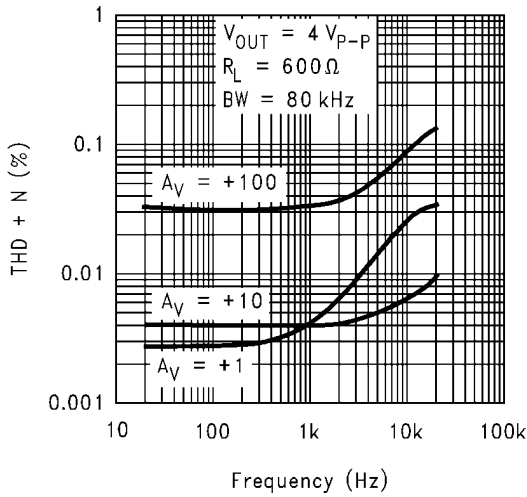

10132541

**THD+N vs. Frequency ( $V_S = 2.7V$ )**

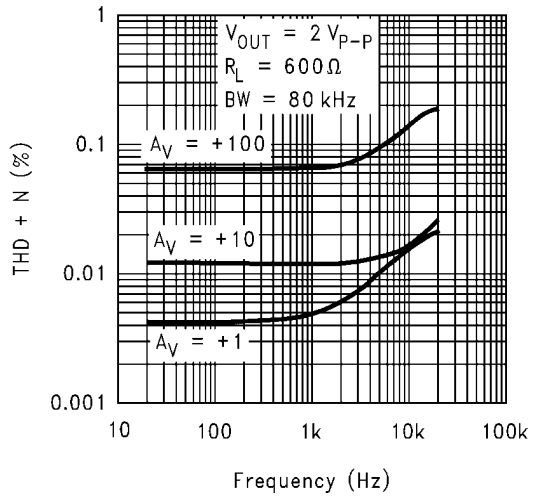

10132542

**THD+N vs.  $V_{OUT}$**

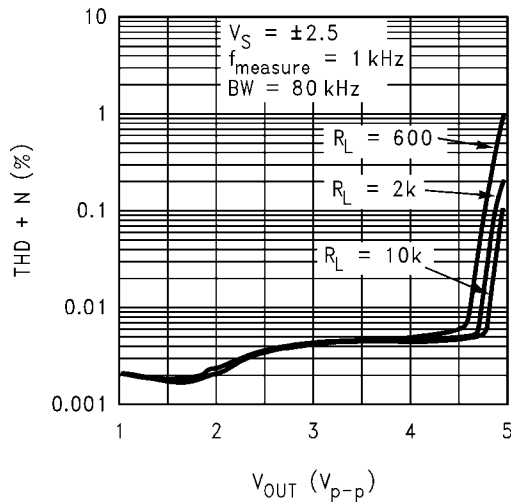

10132543

**THD+N vs.  $V_{OUT}$**

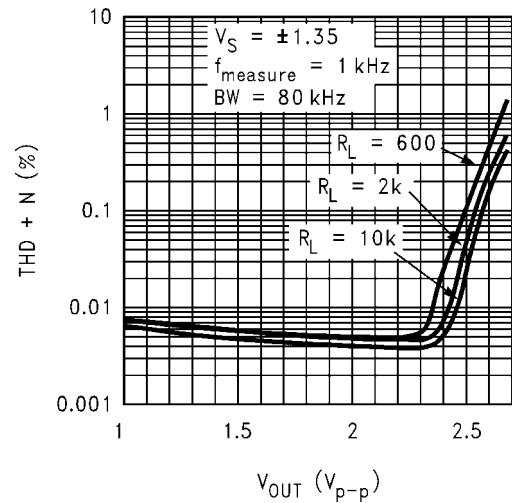

10132544



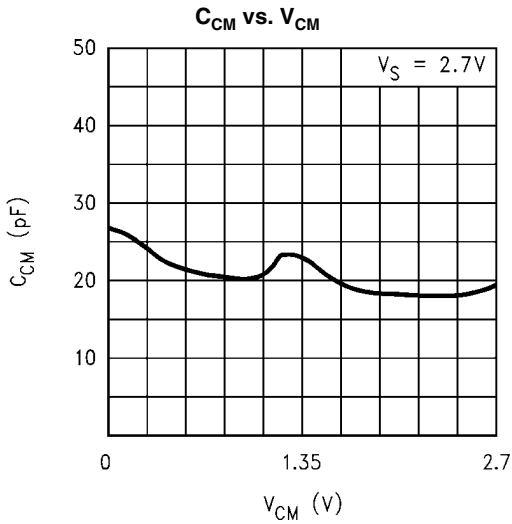

10132545

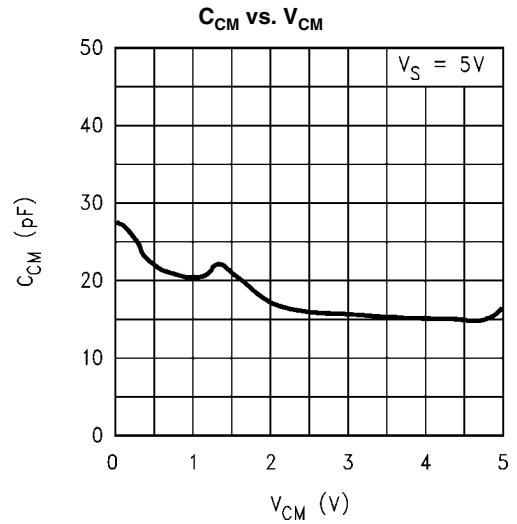

10132546

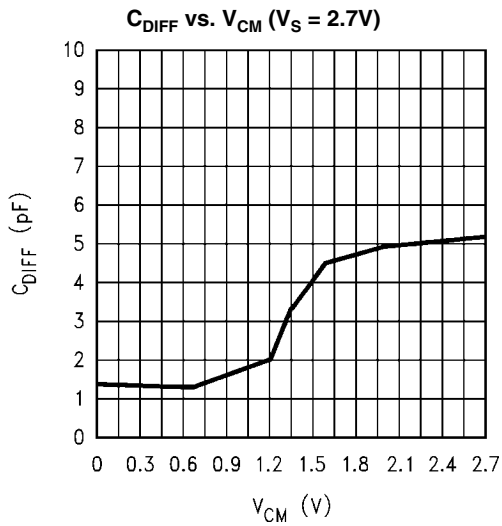

10132547

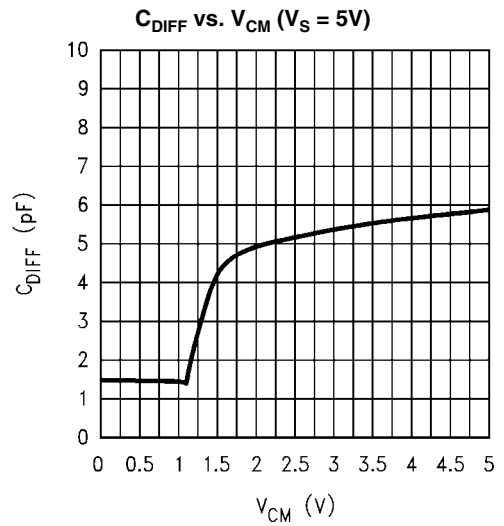

10132548

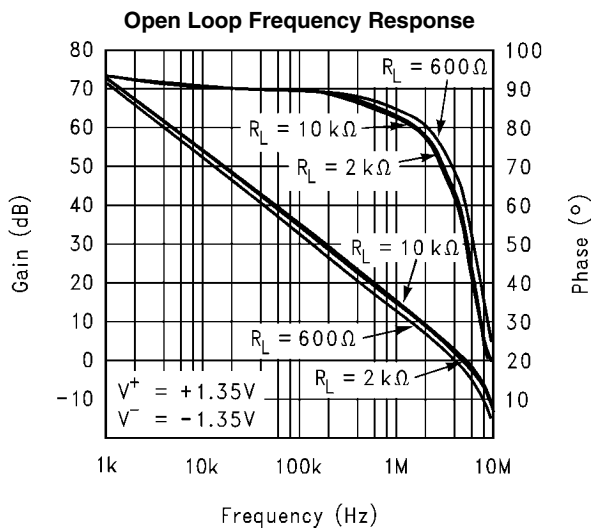

10132512

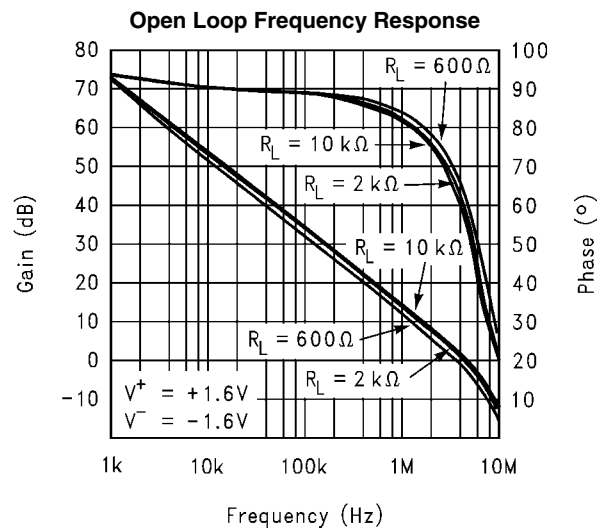

10132510

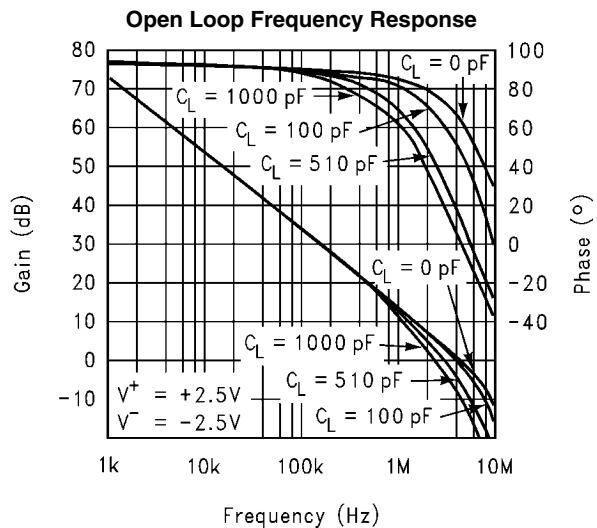
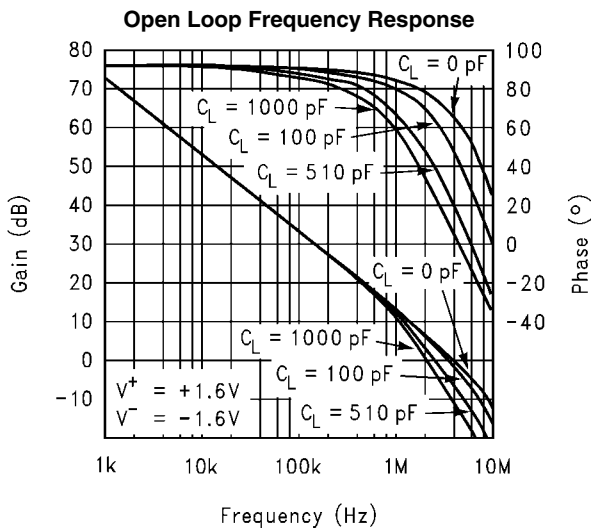
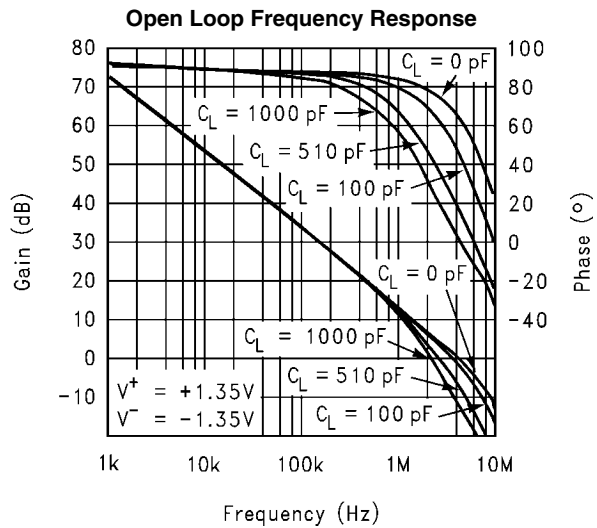
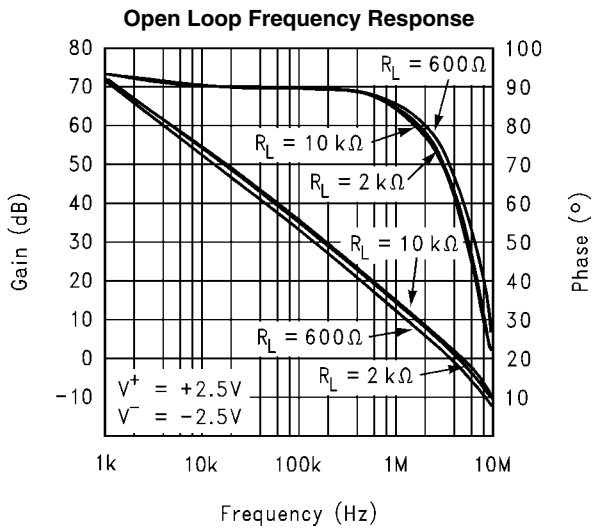

### Non-Inverting Large Signal Pulse Response

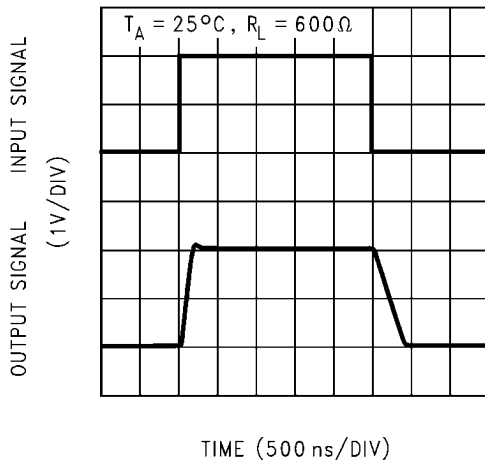

### Non-Inverting Small Signal Pulse Response

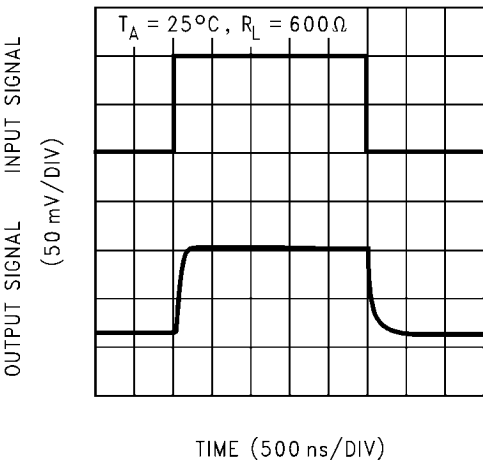

**Inverting Large Signal Pulse Response**

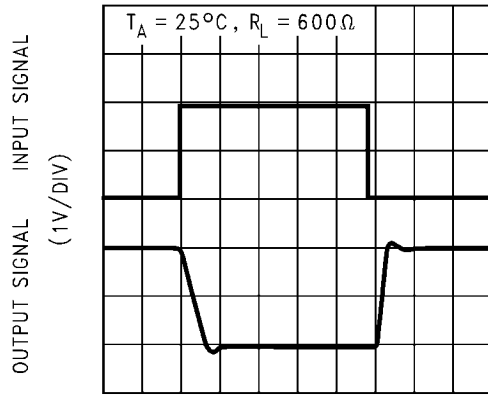

TIME (500 ns/DIV)

10132504

**Inverting Small Signal Pulse Response**

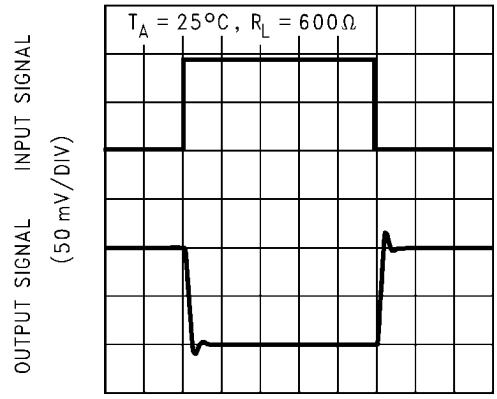

TIME (500 ns/DIV)

10132505

**$V_{OS}$  vs.  $V_{CM}$**

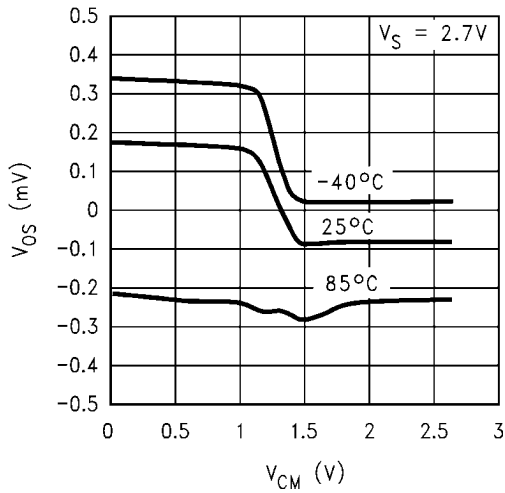

10132549

**$V_{OS}$  vs.  $V_{CM}$**

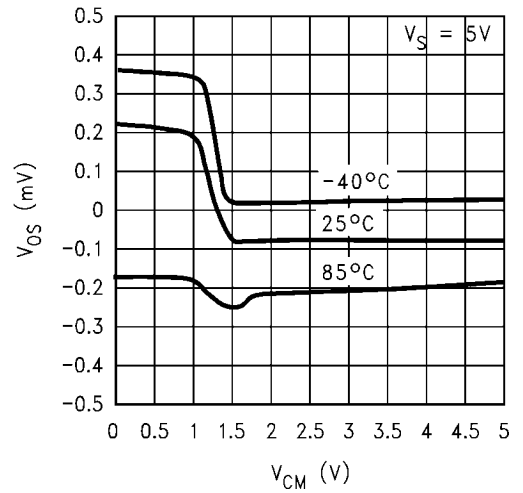

10132550

## Application Information

### 1.0 SUPPLY BYPASSING

The application circuits in this datasheet do not show the power supply connections and the associated bypass capacitors for simplification. When the circuits are built, it is always required to have bypass capacitors. Ceramic disc capacitors (0.1  $\mu\text{F}$ ) or solid tantalum (1  $\mu\text{F}$ ) with short leads, and located close to the IC are usually necessary to prevent interstage coupling through the power supply internal impedance. Inadequate bypassing will manifest itself by a low frequency oscillation or by high frequency instabilities. Sometimes, a 10  $\mu\text{F}$  (or larger) capacitor is used to absorb low frequency variations and a smaller 0.1  $\mu\text{F}$  disc is paralleled across it to prevent any high frequency feedback through the power supply lines.

### 2.0 SHUTDOWN MODE

The LMV711/LMV715 have a shutdown pin. To conserve battery life in portable applications, they can be disabled when the shutdown pin voltage is pulled low. For LMV711 during shutdown mode, the output stays at about 50 mV from the lower rail, and the current drawn from the power supply is 0.2  $\mu\text{A}$  (typical). This makes the LMV711 an ideal solution for power sensitive applications. For the LMV715 during shutdown mode, the output will be "Tri-stated".

The shutdown pin should never be left unconnected. In applications where shutdown operation is not needed and the LMV711 or LMV715 is used, the shutdown pin should be connected to  $V^+$ . Leaving the shutdown pin floating will result in an undefined operation mode and the device may oscillate between shutdown and active modes.

### 3.0 RAIL-TO-RAIL INPUT

The rail-to-rail input is achieved by using paralleled PMOS and NMOS differential input stages. (See Simplified Schematics in this datasheet). When the common mode input voltage changes from ground to the positive rail, the input stage goes through three modes. First, the NMOS pair is cut-off and the PMOS pair is active. At around 1.4V, both PMOS and NMOS pairs operate, and finally the PMOS pair is cut-off and NMOS pair is active. Since both input stages have their own offset voltage ( $V_{OS}$ ), the offset of the amplifier becomes a function of the common-mode input voltage. See curves for  $V_{OS}$  vs.  $V_{CM}$  in curve section.

As shown in the curve, the  $V_{OS}$  has a crossover point at 1.4V above  $V^-$ . Proper design must be done in both DC and AC coupled applications to avoid problems. For large input signals that include the  $V_{OS}$  crossover point in their dynamic range, it will cause distortion in the output signal. One way to avoid such distortion is to keep the signal away from the crossover point. For example, in a unity gain buffer configuration and with  $V_S = 5\text{V}$ , a 3V peak-to-peak signal center at 2.5V will contain input-crossover distortion. To avoid this, the input signal should be centered at 3.5V instead. Another way to avoid large signal distortion is to use a gain of  $-1$  circuit which avoids any voltage excursions at the input terminals of the amplifier. See *Figure 1*. In this circuit, the common mode DC voltage ( $V_{CM}$ ) can be set at a level away from the  $V_{OS}$  crossover point.

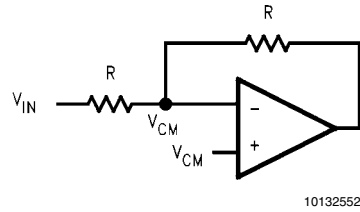

FIGURE 1.

When the input is a small signal and this small signal falls inside the  $V_{OS}$  transition range, the gain, CMRR and some other parameters will be degraded. To resolve this problem, the small signal should be placed such that it avoids the  $V_{OS}$  crossover point.

To achieve maximum output swing, the output should be biased at mid-supply. This is normally done by biasing the input at mid-supply. But with supply voltage range from 2V to 3.4V, the input of the op amp should not be biased at mid-supply because of the transition of the  $V_{OS}$ . *Figure 2* shows an example of how to get away from the  $V_{OS}$  crossover point and maintain a maximum swing with a 2.7V supply. *Figure 3* shows the waveforms of  $V_{IN}$  and  $V_{OUT}$ .

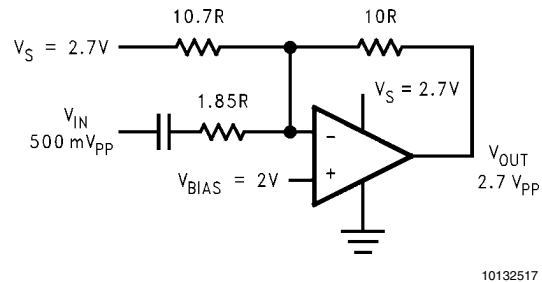

FIGURE 2.

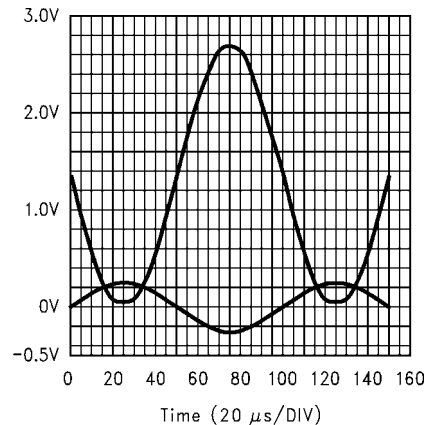
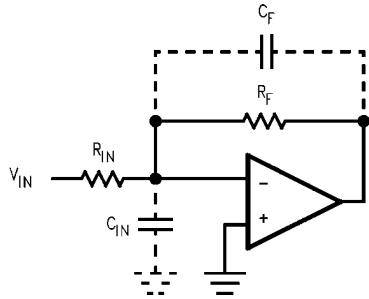

FIGURE 3.

The inputs can be driven 300 mV beyond the supply rails without causing phase reversal at the output. However, the inputs should not be allowed to exceed the maximum ratings.

#### 4.0 COMPENSATION OF INPUT CAPACITANCE

In the application (Figure 4) where a large feedback resistor is used, the feedback resistor can react with the input capacitance of the op amp and introduce an additional pole to the close loop frequency response.



10132518

**FIGURE 4. Cancelling the Effect of Input Capacitance**

This pole occurs at frequency  $f_p$ , where

$$f_p = \frac{1}{2\pi(R_{IN} || R_F)C_{IN}}$$

Any stray capacitance due to external circuit board layout, any source capacitance from transducer or photodiode connected to the summing node will also be added to the input capacitance. If  $f_p$  is less than or close to the unity-gain bandwidth (5 MHz) of the op amp, the phase margin of the loop is reduced and can cause the system to be unstable.

To avoid this problem, make sure that  $f_p$  occurs at least 2 octaves beyond the expected -3 dB frequency corner of the close loop frequency response. If not, a feedback capacitor  $C_F$  can be placed in parallel with  $R_F$  such that

$$\frac{1}{2\pi R_F C_F} = \frac{1}{2\pi(R_{IN} || R_F)(C_F + C_{IN})}$$

The paralleled  $R_F$  and  $C_F$  introduce a zero, which cancels the effect from the pole.

#### 5.0 CAPACITIVE LOAD TOLERANCE

The LMV710/LMV711/ LMV715 can directly drive 200 pF in unity-gain without oscillation. The unity-gain follower is the most sensitive configuration to capacitive loading. Direct capacitive loading reduces the phase margin of amplifiers. The combination of the amplifier's output impedance and the capacitive load induces phase lag. This results in either an underdamped pulse response or oscillation. To drive a heavier capacitive load, circuit in Figure 5 can be used.

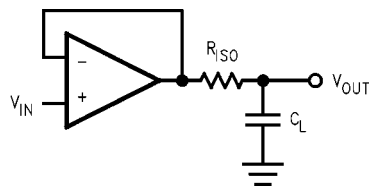

10132521

**FIGURE 5. Indirectly Driving A Capacitive Load using Resistive Isolation**

In Figure 5, the isolation resistor  $R_{ISO}$  and the load capacitor  $C_L$  form a pole to increase stability by adding more phase margin to the overall system. The desired performance depends on the value of  $R_{ISO}$ . The bigger the  $R_{ISO}$  resistor value, the more stable  $V_{OUT}$  will be. But the DC accuracy is not great when the  $R_{ISO}$  gets bigger. If there were a load resistor in Figure 5, the output would be voltage divided by  $R_{ISO}$  and the load resistor.

The circuit in Figure 6 is an improvement to the one in Figure 5 because it provides DC accuracy as well as AC stability. In this circuit,  $R_F$  provides the DC accuracy by using feed-forward techniques to connect  $V_{IN}$  to  $R_L$ .  $C_F$  and  $R_{ISO}$  serve to counteract the loss of phase margin by feeding the high frequency component of the output signal back to the amplifier's inverting input, thereby preserving phase margin in the overall feedback loop. Increased capacitive drive is possible by increasing the value of  $C_F$ . This in turn will slow down the pulse response.

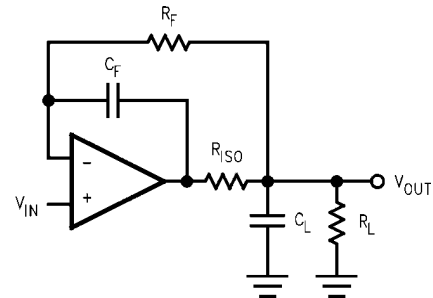

10132522

**FIGURE 6. Indirectly Driving A Capacitive A Load with DC Accuracy**

#### 6.0 APPLICATION CIRCUITS

##### PEAK DETECTOR

Peak detectors are used in many applications, such as test equipment, measurement instrumentation, ultrasonic alarm systems, etc. Figure 7 shows the schematic diagram of a peak detector using LMV710 or LMV711 or LMV715. This peak detector basically consists of a clipper, a parallel RC network, and a voltage follower.

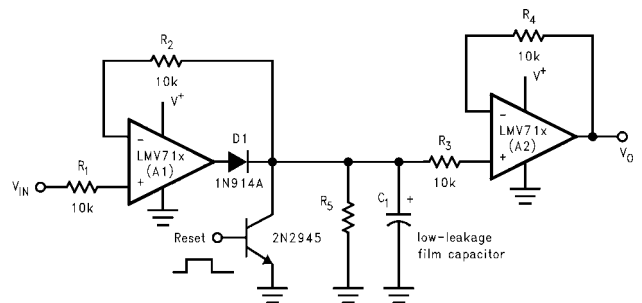

10132523

**FIGURE 7. Peak Detector**

The capacitor  $C_1$  is first discharged by applying a positive pulse to the reset transistor. When a positive voltage  $V_{IN}$  is applied to the input, the input voltage is higher than the voltage across  $C_1$ . The output of the op amp goes high and forward biases the diode  $D_1$ . The capacitor  $C_1$  is charged to  $V_{IN}$ . When the input becomes less than the current capacitor voltage, the output of the op amp A1 goes low and the diode

$D_1$  is reverse biased. This isolates the  $C_1$  and leaves it with the charge equivalent to the peak of the input voltage. The follower prevents unintentional discharging of  $C_1$  by loading from the following circuit.

$R_5$  and  $C_1$  are properly selected so that the capacitor is charged rapidly to  $V_{IN}$ . During the holding period, the capacitor slowly discharge through  $C_1$ , via leakage of the capacitor and the reverse-biased diode, or op amp bias currents. In any cases the discharging time constant is much larger than the charge time constant. And the capacitor can hold its voltage long enough to minimize the output ripple.

Resistors  $R_2$  and  $R_3$  limit the current into the inverting input of A1 and the non-inverting input of A2 when power is disconnected from the circuit. The discharging current from  $C_1$  during power off may damage the input circuitry of the op amps.

The peak detector can be reset by applying a positive pulse to the reset transistor. The charge on the capacitor is dumped into ground, and the detector is ready for another cycle.

The maximum input voltage to this detector should be less than  $(V^+ - V_D)$ , where  $V_D$  is the forward voltage drop of the diode. Otherwise, the input voltage should be scaled down before applying to the circuit.

**HIGH SIDE CURRENT SENSING**

The high side current sensing circuit (Figure 8) is commonly used in a battery charger to monitor charging current to pre-

vent over-charging. A sense resistor  $R_{SENSE}$  is connected to the battery directly. This system requires an op amp with rail-to-rail input. The LMV710/LMV711/LMV715 are ideal for this application because its common mode input range can go beyond the positive rail.

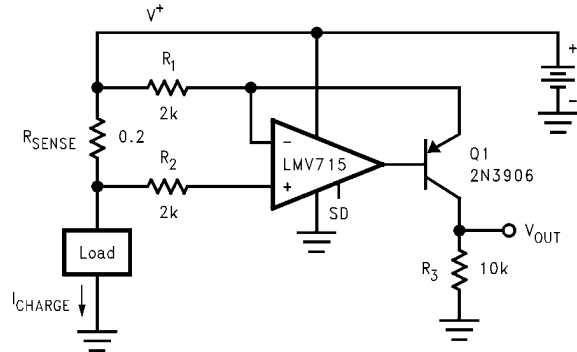

$$V_{OUT} = \frac{R_{SENSE} \cdot R_3}{R_1} \cdot I_{Charge} = 1\Omega \cdot I_{Charge}$$

10132513

**FIGURE 8. High Side Current Sensing**

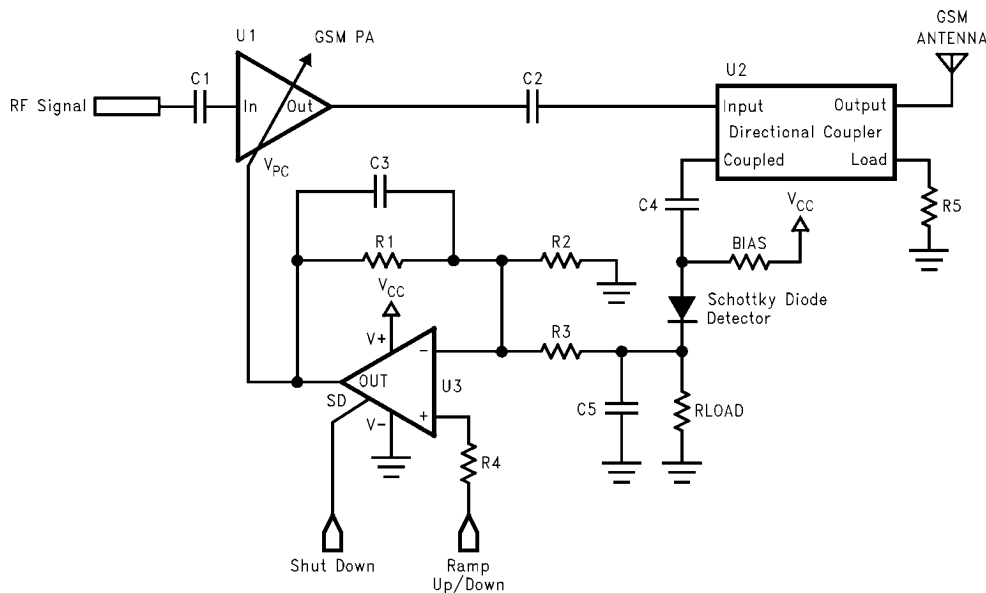

10132506

**FIGURE 9. Typical of GSM P.A. Control Loop**

**GSM POWER AMPLIFIER CONTROL LOOP**

There are four critical sections in the GSM Power Amplifier Control Loop. The class-C  $R_F$  power amplifier provides amplification of the  $R_F$  signal. A directional coupler couples small amount of  $R_F$  energy from the output of the  $R_F$  P. A. to an envelope detector diode. The detector diode senses the signal level and rectifies it to a DC level to indicate the signal strength at the antenna. An op amp is used as an error amplifier to process the diode voltage and ramping voltage. This loop control the power amplifier gain via the op amp and forces the detector diode voltage and ramping voltage to be

equal. Power control is accomplished by changing the ramping voltage.

The LMV710/LMV711/LMV715 are well suited as an error amplifier in this application. The LMV711/LMV715 have an extra shutdown pin to switch the op amp to shutdown mode. In shutdown mode, the LMV711/LMV715 consume very low current. The LMV711 provides a ground voltage to the power amplifier control pin  $V_{PC}$ . Therefore, the power amplifier can be turned off to save battery life. The LMV715 output will be "tri-stated" when in shutdown.

### Simplified Schematic

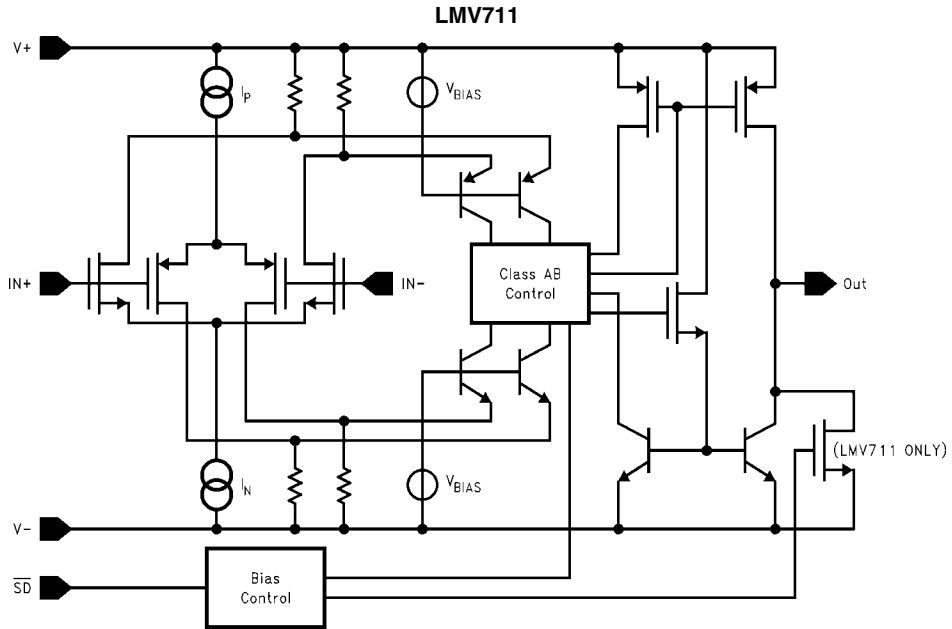

10132516

### Connection Diagrams

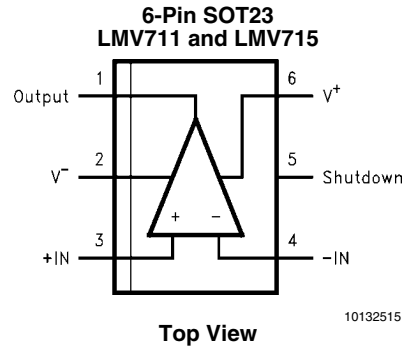
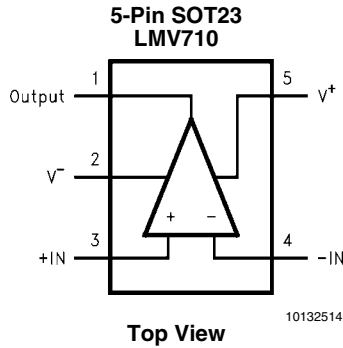

### Ordering Information

Package	Temperature Range Industrial -40°C to +85°C	Packaging Marking	Transport Media	NSC Drawing
5-Pin SOT23	LMV710M5	A48A	1k Units Tape and Reel	MF05A
	LMV710M5X		3k Units Tape and Reel	
6-Pin SOT23	LMV711M6	A47A	1k Units Tape and Reel	MF06A
	LMV711M6X		3k Units Tape and Reel	
	*LMV715MF	A75A	1k Units Tape and Reel	
	*LMV715MFX		3k Units Tape and Reel	

\*LMV715MF/LMV715MFX are not recommended for new designs with a last time buy date of 12/1/2009.

# SOT-23 Tape and Reel Specification

## Tape Format

Tape Section	# Cavities	Cavity Status	Cover Tape Status
Leader (Start End)	0 (min)	Empty	Sealed
	75 (min)	Empty	Sealed
Carrier	3000	Filled	Sealed
	1000	Filled	Sealed
Trailer (Hub End)	125 (min)	Empty	Sealed
	0 (min)	Empty	Sealed

## Tape Dimensions

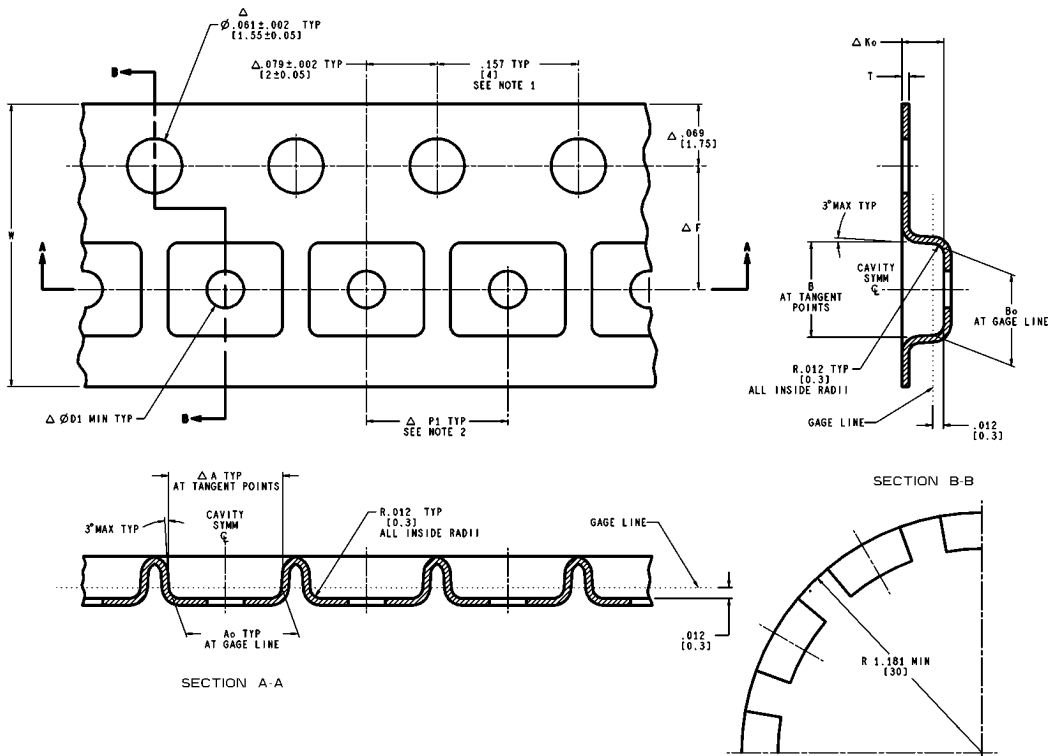

BEND RADIUS  
NOT TO SCALE

39-1461 (Rev R)

10132555

TAPE SIZE	DIM A	DIM A <sub>0</sub>	DIM B	DIM B <sub>0</sub>	DIM F	DIM K <sub>0</sub>	DIM P1	DIM T	DIM W
8 mm	.130 (3.3)	.124 (3.15)	.130 (3.3)	.126 (3.2)	.138 ± .002 (3.5 ± 0.05)	.055 ± .004 (1.4 ± 0.1)	.157 (4)	.008 ± .004 (0.2 ± 0.1)	.315 ± .012 (8 ± 0.3)

**Note:** UNLESS OTHERWISE SPECIFIED

1. CUMULATIVE PITCH TOLERANCE FOR FEEDING HOLES AND CAVITIES (CHIP POCKETS) NOT TO EXCEED .008 IN / 0.2mm OVER 10 PITCH SPAN.

2. THRU HOLE INSIDE CAVITY IS CENTERED WITHIN CAVITY.

3. SMALLEST ALLOWABLE TAPE BENDING RADIUS: 1.181 IN / 30mm.

4. DIMENSIONS WITH  $\Delta$  ARE CRITICAL. DIMENSIONS TO BE ABSOLUTELY INSPECTED.



# Reel Dimensions

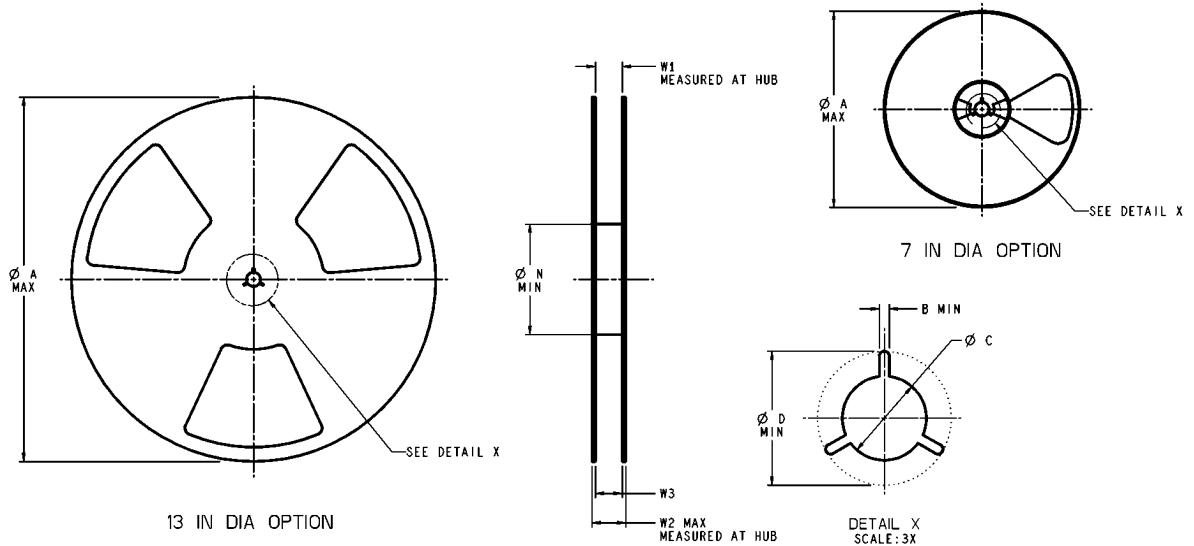

39-1922 (Rev H)

10132554

TAPE SIZE	DIM A	DIM B	DIM C	DIM D	DIM N	DIM W1	DIM W2	DIM W3 (LSL-USL)
8 mm	7.00 (177.8)	.059 (1.5)	.512 + .020/-0.008 (13 +0.5/-0.2)	.795 (20.2)	2.165 (55)	.331 + .059/-0.000 (8.4 + 1.5/0)	.567 (14.4)	.311 - .429 (7.9 - 10.9)

**Note:** UNLESS OTHERWISE SPECIFIED

1. MATERIAL:  
POLYSTYRENE/PVC (WITH ANTISTATIC COATING).  
OR POLYSTYRENE/PVC, ANTISTATIC  
OR POLYSTYRENE/PVC, CONDUCTIVE.
2. CONTROLLING DIMENSION IS MILLIMETER, DIMENSIONS IN INCHES ROUNDED.
3. SURFACE RESISTIVITY:  $10^{10}$  OHM/SQ MAXIMUM.
4. ALL OUTPUT REELS SHALL BE UNIFORM IN SHADE.
5. PACKING OF REELS IN CONTAINERS MUST ENSURE NO DAMAGE TO THE REEL.
6. SURFACE FINISH OF THE FLANGES SHALL BE SMOOTH, MATTE FINISH PREFERRED.
7. ALL EDGES, ESPECIALLY THE TAPE ENTRY EDGES, MUST BE FREE OF BURRS.
8. THE REEL SHOULD NOT WARP IN THE STORAGE TEMPERATURE OF 67°C MAXIMUM.
9. GLASS TRANSITION TEMPERATURE ( $T_g$ ) OF THE PLASTIC REEL SHALL BE LOWER THAN -20°C.

10. ALL GATING FROM THE MOLD MUST BE PROPERLY REMOVED.
11. NO FLASHES ARE TO BE PRESENT ALONG THE PARTING LINES.
12. ALLOWABLE RADIUS FOR CORNERS AND EDGES IS .012 INCHES/0.3 MILLIMETERS MINIMUM.
13. SINK MARKS THAT WILL CAUSE A CHANGE TO THE SPECIFIED DIMENSIONS OR SHAPE OF THE REELS ARE NOT ALLOWED.
14. MOLDED REELS SHALL BE FREE OF COSMETIC DEFECTS SUCH AS VOIDS, FLASHING, EXCESSIVE FLOW MARKS, ETC.
15. THERE MUST BE NO MISMATCH BETWEEN MATING PARTS.
16. MOLDED REELS SHALL BE ANTISTATIC COATED OR BLENDED.
17. THE SOT23-5L AND SOT23-6L PACKAGE USE THE 7-INCH REEL.

**Physical Dimensions** inches (millimeters) unless otherwise noted

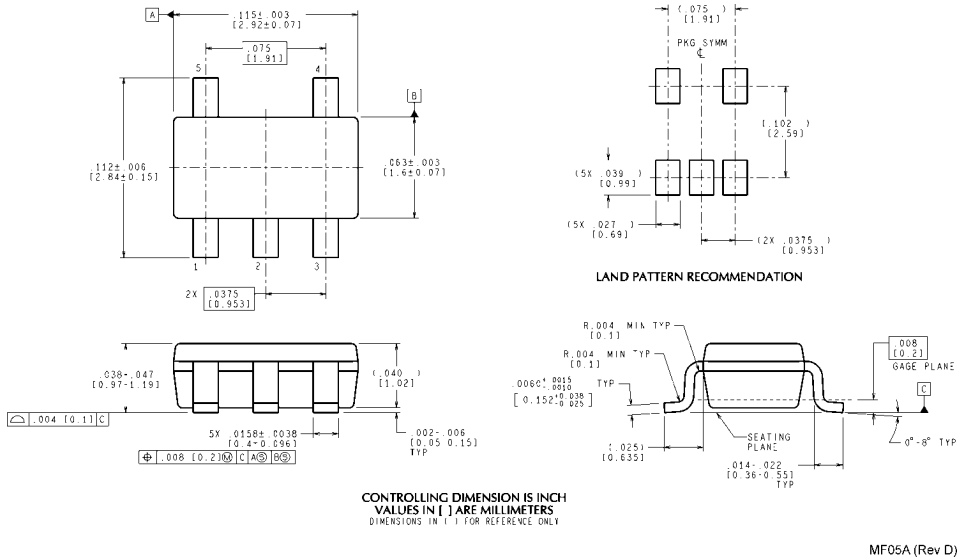

**SOT23-5  
NS Package Number MF05A**

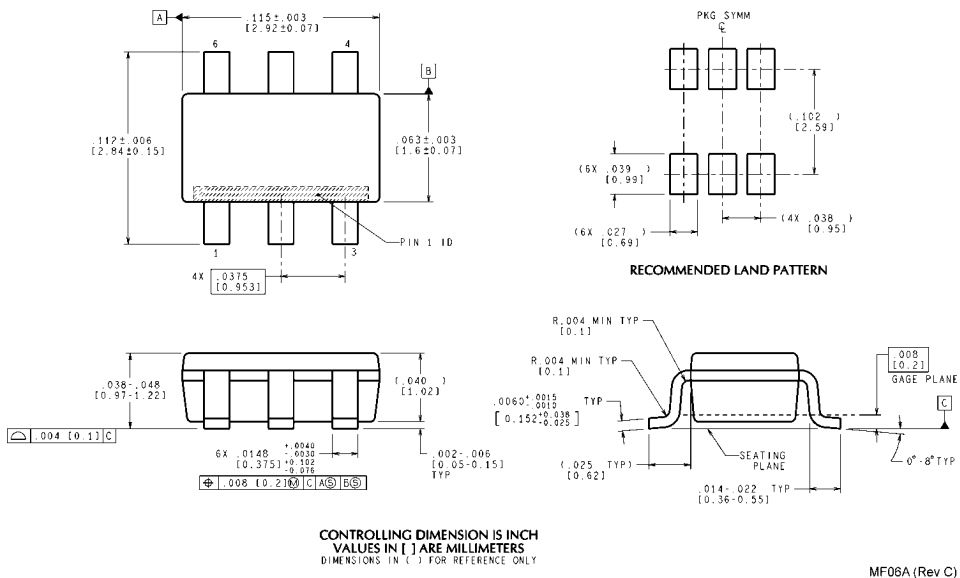

**SOT23-6  
NS Package Number MF06A**

## Notes

For more National Semiconductor product information and proven design tools, visit the following Web sites at:

Products		Design Support	
Amplifiers	<a href="http://www.national.com/amplifiers">www.national.com/amplifiers</a>	WEBENCH® Tools	<a href="http://www.national.com/webench">www.national.com/webench</a>
Audio	<a href="http://www.national.com/audio">www.national.com/audio</a>	App Notes	<a href="http://www.national.com/appnotes">www.national.com/appnotes</a>
Clock and Timing	<a href="http://www.national.com/timing">www.national.com/timing</a>	Reference Designs	<a href="http://www.national.com/refdesigns">www.national.com/refdesigns</a>
Data Converters	<a href="http://www.national.com/adc">www.national.com/adc</a>	Samples	<a href="http://www.national.com/samples">www.national.com/samples</a>
Interface	<a href="http://www.national.com/interface">www.national.com/interface</a>	Eval Boards	<a href="http://www.national.com/evalboards">www.national.com/evalboards</a>
LVDS	<a href="http://www.national.com/lvds">www.national.com/lvds</a>	Packaging	<a href="http://www.national.com/packaging">www.national.com/packaging</a>
Power Management	<a href="http://www.national.com/power">www.national.com/power</a>	Green Compliance	<a href="http://www.national.com/quality/green">www.national.com/quality/green</a>
Switching Regulators	<a href="http://www.national.com/switchers">www.national.com/switchers</a>	Distributors	<a href="http://www.national.com/contacts">www.national.com/contacts</a>
LDOs	<a href="http://www.national.com/ldo">www.national.com/ldo</a>	Quality and Reliability	<a href="http://www.national.com/quality">www.national.com/quality</a>
LED Lighting	<a href="http://www.national.com/led">www.national.com/led</a>	Feedback/Support	<a href="http://www.national.com/feedback">www.national.com/feedback</a>
Voltage Reference	<a href="http://www.national.com/vref">www.national.com/vref</a>	Design Made Easy	<a href="http://www.national.com/easy">www.national.com/easy</a>
PowerWise® Solutions	<a href="http://www.national.com/powerwise">www.national.com/powerwise</a>	Solutions	<a href="http://www.national.com/solutions">www.national.com/solutions</a>
Serial Digital Interface (SDI)	<a href="http://www.national.com/sdi">www.national.com/sdi</a>	Mil/Aero	<a href="http://www.national.com/milaero">www.national.com/milaero</a>
Temperature Sensors	<a href="http://www.national.com/tempsensors">www.national.com/tempsensors</a>	Solar Magic®	<a href="http://www.national.com/solarmagic">www.national.com/solarmagic</a>
Wireless (PLL/VCO)	<a href="http://www.national.com/wireless">www.national.com/wireless</a>	Analog University®	<a href="http://www.national.com/AU">www.national.com/AU</a>

THE CONTENTS OF THIS DOCUMENT ARE PROVIDED IN CONNECTION WITH NATIONAL SEMICONDUCTOR CORPORATION ("NATIONAL") PRODUCTS. NATIONAL MAKES NO REPRESENTATIONS OR WARRANTIES WITH RESPECT TO THE ACCURACY OR COMPLETENESS OF THE CONTENTS OF THIS PUBLICATION AND RESERVES THE RIGHT TO MAKE CHANGES TO SPECIFICATIONS AND PRODUCT DESCRIPTIONS AT ANY TIME WITHOUT NOTICE. NO LICENSE, WHETHER EXPRESS, IMPLIED, ARISING BY ESTOPPEL OR OTHERWISE, TO ANY INTELLECTUAL PROPERTY RIGHTS IS GRANTED BY THIS DOCUMENT.

TESTING AND OTHER QUALITY CONTROLS ARE USED TO THE EXTENT NATIONAL DEEMS NECESSARY TO SUPPORT NATIONAL'S PRODUCT WARRANTY. EXCEPT WHERE MANDATED BY GOVERNMENT REQUIREMENTS, TESTING OF ALL PARAMETERS OF EACH PRODUCT IS NOT NECESSARILY PERFORMED. NATIONAL ASSUMES NO LIABILITY FOR APPLICATIONS ASSISTANCE OR BUYER PRODUCT DESIGN. BUYERS ARE RESPONSIBLE FOR THEIR PRODUCTS AND APPLICATIONS USING NATIONAL COMPONENTS. PRIOR TO USING OR DISTRIBUTING ANY PRODUCTS THAT INCLUDE NATIONAL COMPONENTS, BUYERS SHOULD PROVIDE ADEQUATE DESIGN, TESTING AND OPERATING SAFEGUARDS.

EXCEPT AS PROVIDED IN NATIONAL'S TERMS AND CONDITIONS OF SALE FOR SUCH PRODUCTS, NATIONAL ASSUMES NO LIABILITY WHATSOEVER, AND NATIONAL DISCLAIMS ANY EXPRESS OR IMPLIED WARRANTY RELATING TO THE SALE AND/OR USE OF NATIONAL PRODUCTS INCLUDING LIABILITY OR WARRANTIES RELATING TO FITNESS FOR A PARTICULAR PURPOSE, MERCHANTABILITY, OR INFRINGEMENT OF ANY PATENT, COPYRIGHT OR OTHER INTELLECTUAL PROPERTY RIGHT.

### LIFE SUPPORT POLICY

**NATIONAL'S PRODUCTS ARE NOT AUTHORIZED FOR USE AS CRITICAL COMPONENTS IN LIFE SUPPORT DEVICES OR SYSTEMS WITHOUT THE EXPRESS PRIOR WRITTEN APPROVAL OF THE CHIEF EXECUTIVE OFFICER AND GENERAL COUNSEL OF NATIONAL SEMICONDUCTOR CORPORATION.** As used herein:

Life support devices or systems are devices which (a) are intended for surgical implant into the body, or (b) support or sustain life and whose failure to perform when properly used in accordance with instructions for use provided in the labeling can be reasonably expected to result in a significant injury to the user. A critical component is any component in a life support device or system whose failure to perform can be reasonably expected to cause the failure of the life support device or system or to affect its safety or effectiveness.

National Semiconductor and the National Semiconductor logo are registered trademarks of National Semiconductor Corporation. All other brand or product names may be trademarks or registered trademarks of their respective holders.

Copyright© 2009 National Semiconductor Corporation

For the most current product information visit us at [www.national.com](http://www.national.com)



**National Semiconductor Americas Technical Support Center**  
 Email: [support@nsc.com](mailto:support@nsc.com)  
 Tel: 1-800-272-9959

**National Semiconductor Europe Technical Support Center**  
 Email: [europe.support@nsc.com](mailto:europe.support@nsc.com)  
 German Tel: +49 (0) 180 5010 771  
 English Tel: +44 (0) 870 850 4288

**National Semiconductor Asia Pacific Technical Support Center**  
 Email: [ap.support@nsc.com](mailto:ap.support@nsc.com)

**National Semiconductor Japan Technical Support Center**  
 Email: [jpn.feedback@nsc.com](mailto:jpn.feedback@nsc.com)