

National Semiconductor is now part of
Texas Instruments.

Search <http://www.ti.com/> for the latest technical
information and details on our current products and services.

LM4818 Boomer® Audio Power Amplifier Series

350mW Audio Power Amplifier with Shutdown Mode

General Description

The LM4818 is a mono bridged power amplifier that is capable of delivering 350mW_{RMS} output power into a 16Ω load or 300mW_{RMS} output power into an 8Ω load with 10% THD+N from a 5V power supply.

The LM4818 Boomer audio power amplifier is designed specifically to provide high quality output power and minimize PCB area with surface mount packaging and a minimal amount of external components. Since the LM4818 does not require output coupling capacitors, bootstrap capacitors or snubber networks, it is optimally suited for low-power portable applications.

The closed loop response of the unity-gain stable LM4818 can be configured using external gain-setting resistors. The device is available in SO package type to suit various applications.

Key Specifications

- THD+N at 1kHz, 350mW continuous average output power into 16Ω 10% (max)
- THD+N at 1kHz, 300mW continuous average output power into 8Ω 10% (max)
- Shutdown Current 0.7μA (typ)

Features

- SOP surface mount packaging.
- Switch on/off click suppression.
- Unity-gain stable.
- Minimum external components.

Applications

- General purpose audio
- Portable electronic devices
- Information Appliances (IA)

Typical Application

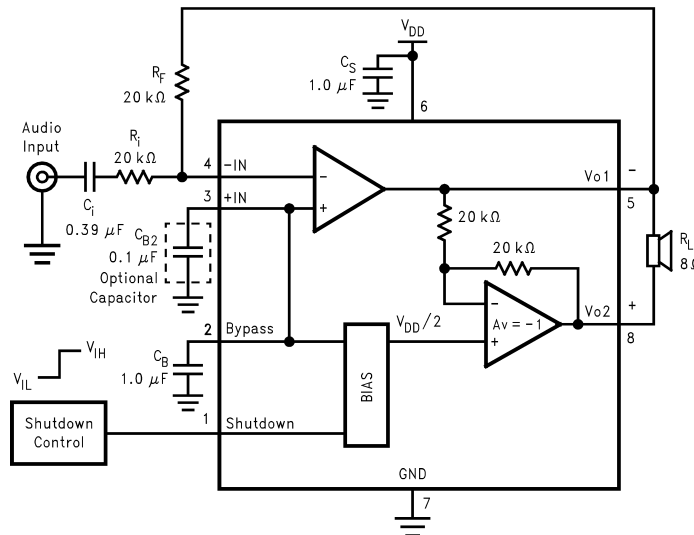

20038901

FIGURE 1. Typical Audio Amplifier Application Circuit

Connection Diagrams

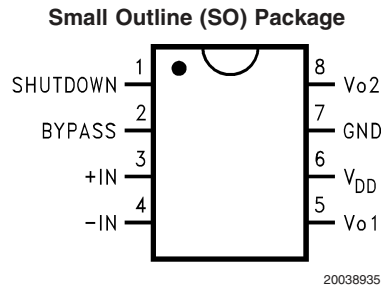

Top View
Order Number LM4818M
See NS Package Number M08A

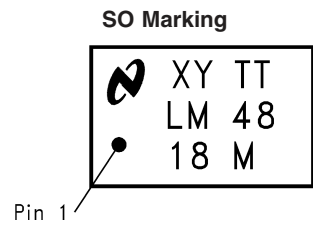

Top View
XY - Date Code
TT - Die Traceability
Bottom 2 lines - Part Number

Absolute Maximum Ratings (Notes 2, 3)

If Military/Aerospace specified devices are required, please contact the National Semiconductor Sales Office/Distributors for availability and specifications.

Supply Voltage	6.0V
Storage Temperature	-65°C to +150°C
Input Voltage	-0.3V to $V_{DD} + 0.3V$
Power Dissipation (P_D) (Note 4)	Internally Limited
ESD Susceptibility (Note 5)	2.5kV
ESD Susceptibility (Note 6)	200V
Junction Temperature (T_J)	150°C
Soldering Information (Note 1)	

Small Outline Package

Vapor Phase (60 seconds) 215°C

Infrared (15 seconds) 220°C

Thermal Resistance

 θ_{JC} (SOP) 35°C/W θ_{JA} (SOP) 170°C/W**Operating Ratings** (Notes 2, 3)

Temperature Range

 $T_{MIN} \leq T_A \leq T_{MAX}$ -40°C $\leq T_A \leq$ 85°CSupply Voltage $2.0V \leq V_{CC} \leq 5.5V$ **Electrical Characteristics $V_{DD} = 5V$** (Notes 2, 3)The following specifications apply for $V_{DD} = 5V$, $R_L = 16\Omega$ unless otherwise stated. Limits apply for $T_A = 25^\circ C$.

Symbol	Parameter	Conditions	LM4818		Units (Limits)
			Typical	Limit	
			(Note 7)	(Notes 8, 9)	
I_{DD}	Quiescent Power Supply Current	$V_{IN} = 0V, I_o = 0A$	1.5	3.0	mA (max)
I_{SD}	Shutdown Current	$V_{PIN1} = V_{DD}$ (Note 10)	1.0	5.0	μA (max)
I_{SDIH}	Shutdown Voltage Input High			4.0	V (min)
I_{SDIL}	Shutdown Voltage Input Low			1.0	V (max)
V_{OS}	Output Offset Voltage	$V_{IN} = 0V$	5	50	mV (max)
P_O	Output Power	THD = 10%, $f_{IN} = 1kHz$	350		mW
		THD = 10%, $f_{IN} = 1kHz, R_L = 8\Omega$	300		mW
THD+N	Total Harmonic Distortion + Noise	$P_O = 270mW_{RMS}, A_{VD} = 2, f_{IN} = 1kHz$	1		%

Electrical Characteristics $V_{DD} = 3V$ (Notes 2, 3)The following specifications apply for $V_{DD} = 3V$ and $R_L = 16\Omega$ load unless otherwise stated. Limits apply to $T_A = 25^\circ C$.

Symbol	Parameter	Conditions	LM4818		Units (Limits)
			Typical	Limit	
			(Note 7)	(Notes 8, 9)	
I_{DD}	Quiescent Power Supply Current	$V_{IN} = 0V, I_o = 0A$	1.0	3.0	mA (max)
I_{SD}	Shutdown Current	$V_{PIN1} = V_{DD}$ (Note 10)	0.7	5.0	μA (max)
I_{SDIH}	Shutdown Voltage Input High			2.4	V (min)
I_{SDIL}	Shutdown Voltage Input Low			0.6	V (max)
V_{OS}	Output Offset Voltage	$V_{IN} = 0V$	5	50	mV
P_O	Output Power	THD = 10%, $f_{IN} = 1kHz$	110		mW
		THD = 10%, $f_{IN} = 1kHz, R_L = 8\Omega$	90		mW
THD+N	Total Harmonic Distortion + Noise	$P_O = 80mW_{RMS}, A_{VD} = 2, f_{IN} = 1kHz$	1		%

Electrical Characteristics $V_{DD} = 3V$ (Notes 2, 3)

The following specifications apply for $V_{DD} = 3V$ and $R_L = 16\Omega$ load unless otherwise stated. Limits apply to $T_A = 25^\circ C$. (Continued)

Note 1: See AN-450 "Surface Mounting and their Effects on Product Reliability" for other methods of soldering surface mount devices.

Note 2: All voltages are measured with respect to the ground pin, unless otherwise specified.

Note 3: *Absolute Maximum Ratings* indicate limits beyond which damage to the device may occur. *Operating Ratings* indicate conditions for which the device is functional, but do not guarantee specific performance limits. *Electrical Characteristics* state DC and AC electrical specifications under particular test conditions which guarantee specific performance limits. This assumes that the device is within the Operating Ratings. Specifications are not guaranteed for parameters where no limit is given. However, the typical value is a good indication of device's performance.

Note 4: The maximum power dissipation must be derated at elevated temperatures and is dictated by T_{JMAX} , θ_{JA} , and the ambient temperature T_A . The maximum allowable power dissipation is $P_{DMAX} = (T_{JMAX} - T_A) / \theta_{JA}$. For the LM4818, $T_{JMAX} = 150^\circ C$ and the typical junction-to-ambient thermal resistance (θ_{JA}) when board mounted is $170^\circ C/W$ for the SOP package.

Note 5: Human body model, 100pF discharged through a 1.5 k Ω resistor.

Note 6: Machine Model, 220pF–240pF capacitor is discharged through all pins.

Note 7: Typical specifications are specified at $25^\circ C$ and represent the parametric norm.

Note 8: Tested limits are guaranteed to National's AOQL (Average Outgoing Quality Level).

Note 9: Datasheet min/max specification limits are guaranteed by designs, test, or statistical analysis.

Note 10: The Shutdown pin (pin 1) should be driven as close as possible to V_{DD} for minimum current in Shutdown Mode.

External Components Description (Figure 1)

Components		Functional Description
1.	R_i	Combined with R_f , this inverting input resistor sets the closed-loop gain. R_i also forms a high pass filter with C_i at $f_c = 1/(2\pi R_i C_i)$.
2.	C_i	This input coupling capacitor blocks DC voltage at the amplifier's terminals. Combined with R_i , it creates a high pass filter with R_i at $f_c = 1/(2\pi R_i C_i)$. Refer to the section, Proper Selection of External Components for an explanation of how to determine the value of C_i .
3.	R_f	Combined with R_i , this is the feedback resistor that sets the closed-loop gain: $A_v = 2(R_f/R_i)$.
4.	C_s	This is the power supply bypass capacitor that filters the voltage applied to the power supply pin. Refer to the Application Information section for proper placement and selection of C_s .
5.	C_B	This is the bypass pin capacitor that filters the voltage at the BYPASS pin. Refer to the section, Proper Selection of External Components for information concerning proper placement and selection of C_B .
6.	C_{B2}	This is an optional capacitor that is not needed in the majority of applications. If the capacitor is not used, pin 3 should be connected directly to pin2. Refer to the section Proper Selection of External Components for more information concerning C_{B2} .

Typical Performance Characteristics

THD+N vs Frequency

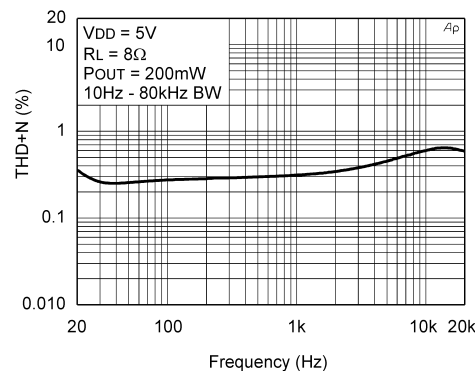

THD+N vs Frequency

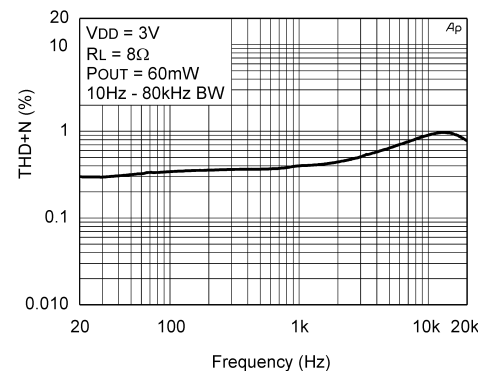

Typical Performance Characteristics (Continued)

THD+N vs Frequency

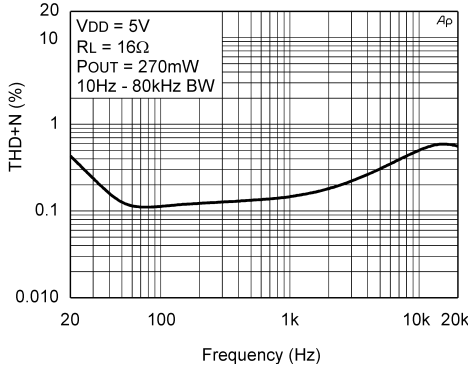

THD+N vs Frequency

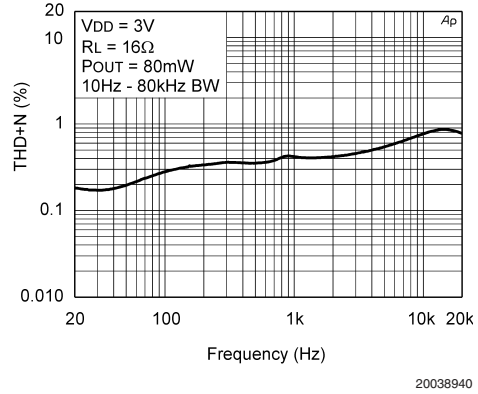

THD+N vs Frequency

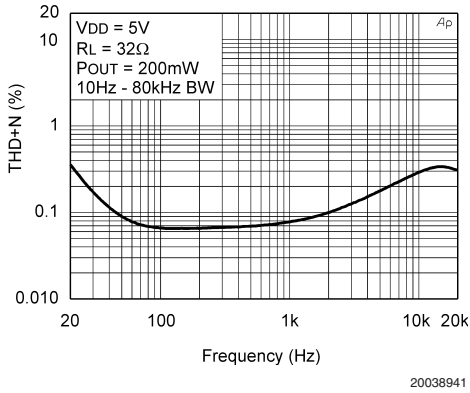

THD+N vs Frequency

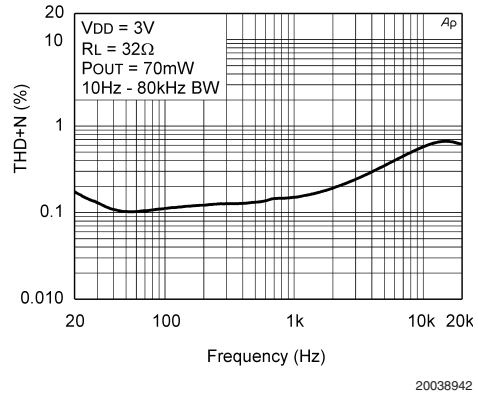

THD+N vs Output Power

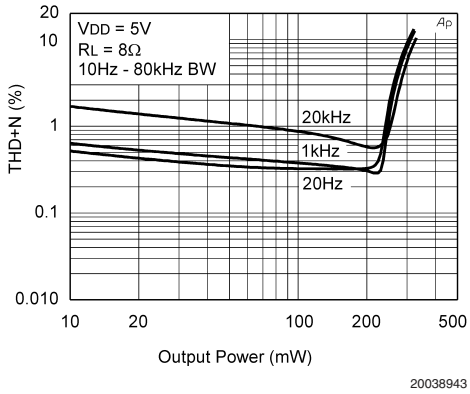

THD+N vs Output Power

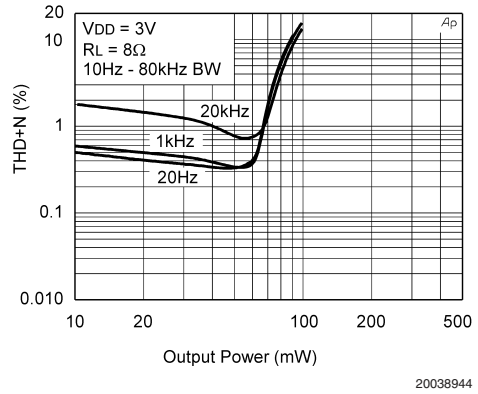

Typical Performance Characteristics (Continued)

THD+N vs Output Power

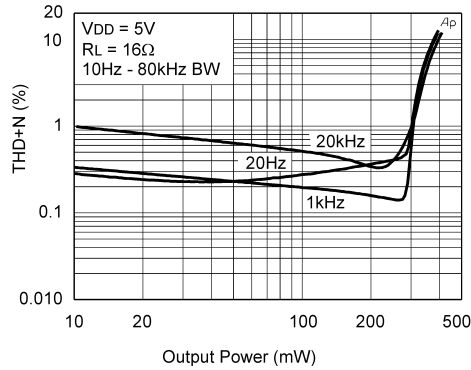

THD+N vs Output Power

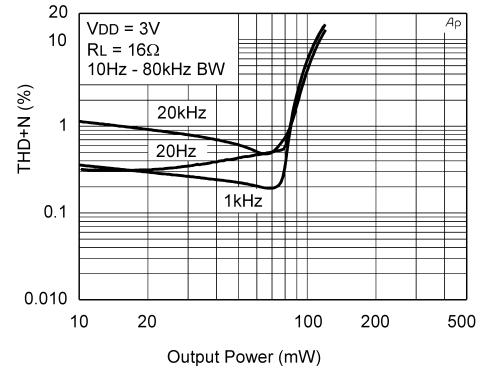

THD+N vs Output Power

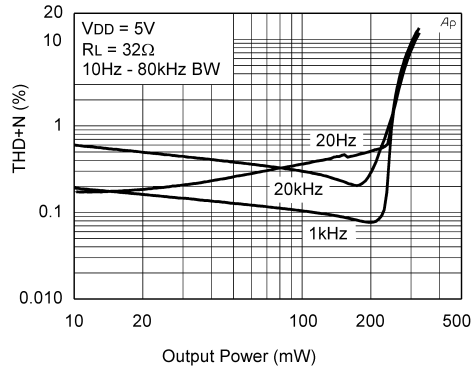

THD+N vs Output Power

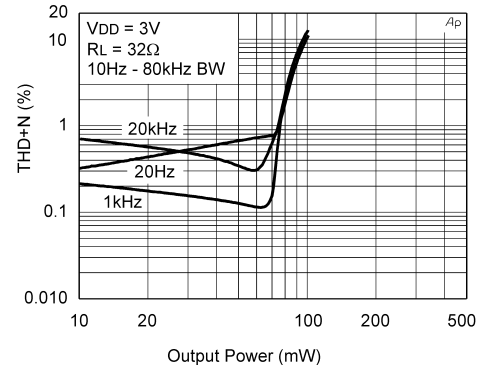

Output Power vs Supply Voltage
RL = 8Ω

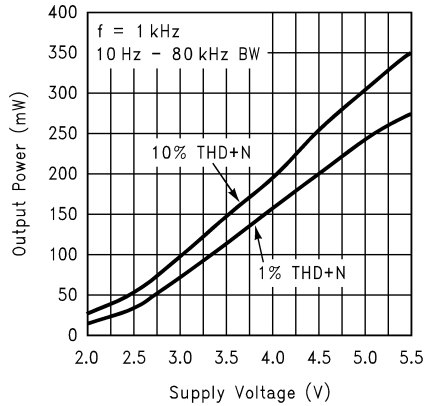

Output Power vs Supply Voltage
RL = 16Ω

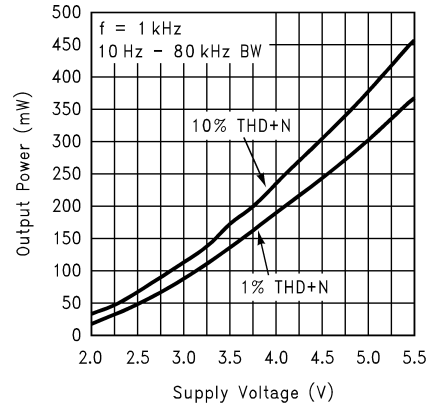

Typical Performance Characteristics (Continued)

Output Power vs Supply Voltage
 $R_L = 32\Omega$

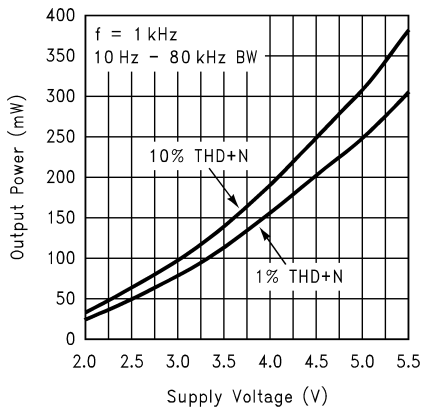

20038951

Output Power vs Load Resistance

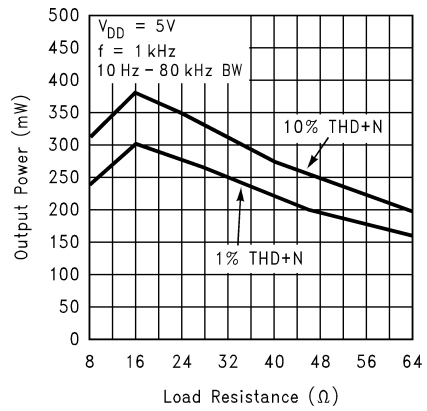

20038950

Power Dissipation vs Output Power
 $V_{DD} = 5V$

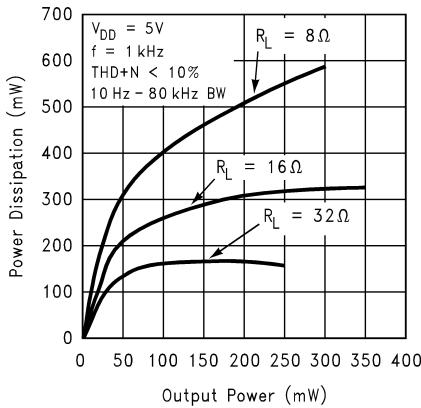

20038953

Power Dissipation vs Output Power
 $V_{DD} = 3V$

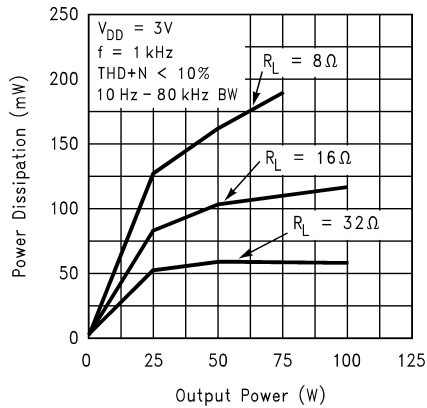

20038952

Power Derating Curves

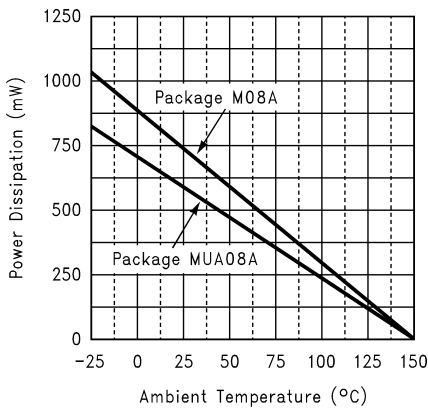

20038955

Frequency Response vs Input Capacitor Size

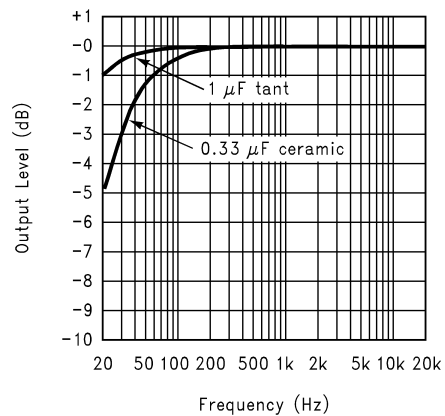

20038954

Typical Performance Characteristics (Continued)

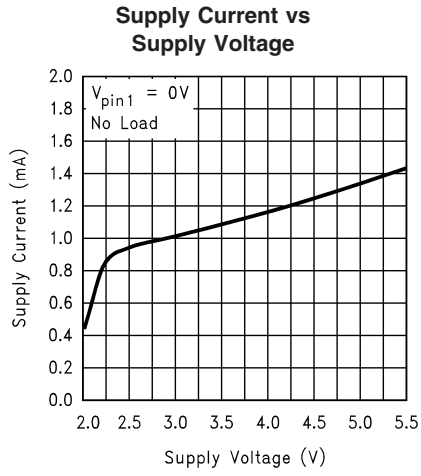

Application Information

BRIDGE CONFIGURATION EXPLANATION

As shown in *Figure 1*, the LM4818 consist of two operational amplifiers. External resistors, R_i and R_f set the closed-loop gain of the first amplifier (and the amplifier overall), whereas two internal 20k Ω resistors set the second amplifier's gain at -1. The LM4818 is typically used to drive a speaker connected between the two amplifier outputs.

Figure 1 shows that the output of Amp1 serves as the input to Amp2, which results in both amplifiers producing signals identical in magnitude but 180° out of phase. Taking advantage of this phase difference, a load is placed between V_{O1} and V_{O2} and driven differentially (commonly referred to as "bridge mode"). This results in a differential gain of

$$A_{VD} = 2 * (R_f/R_i) \quad (1)$$

Bridge mode is different from single-ended amplifiers that drive loads connected between a single amplifier's output and ground. For a given supply voltage, bridge mode has a distinct advantage over the single-ended configuration: its differential output doubles the voltage swing across the load. This results in four times the output power when compared to a single-ended amplifier under the same conditions. This increase in attainable output assumes that the amplifier is not current limited or the output signal is not clipped. To ensure minimum output signal clipping when choosing an amplifier's closed-loop gain, refer to the **Audio Power Amplifier Design Example** section.

Another advantage of the differential bridge output is no net DC voltage across the load. This results from biasing V_{O1} and V_{O2} at half-supply. This eliminates the coupling capacitor that single supply, single-ended amplifiers require. Eliminating an output coupling capacitor in a single-ended configuration forces a single supply amplifier's half-supply bias voltage across the load. The current flow created by the half-supply bias voltage increases internal IC power dissipation and may permanently damage loads such as speakers.

POWER DISSIPATION

Power dissipation is a major concern when designing a successful bridged or single-ended amplifier. Equation (2) states the maximum power dissipation point for a single-ended amplifier operating at a given supply voltage and driving a specified load.

$$P_{DMAX} = (V_{DD})^2 / (2\pi^2 R_L) \quad (W) \text{ Single-ended} \quad (2)$$

However, a direct consequence of the increased power delivered to the load by a bridged amplifier is an increase in the internal power dissipation point for a bridge amplifier operating at the same given conditions. Equation (3) states the maximum power dissipation point for a bridged amplifier operating at a given supply voltage and driving a specified load.

$$P_{DMAX} = 4(V_{DD})^2 / (2\pi^2 R_L) \quad (W) \text{ Bridge Mode} \quad (3)$$

The LM4818 has two operational amplifiers in one package and the maximum internal power dissipation is four times that of a single-ended amplifier. However, even with this substantial increase in power dissipation, the LM4818 does not require heatsinking. From Equation (3), assuming a 5V power supply and an 8 Ω load, the maximum power dissipation point is 633mW. The maximum power dissipation point obtained from Equation (3) must not exceed the power dissipation predicted by Equation (4):

$$P_{DMAX} = (T_{JMAX} - T_A) / \theta_{JA} \quad (W) \quad (4)$$

For the M08A package, $\theta_{JA} = 170^\circ\text{C/W}$ and $T_{JMAX} = 150^\circ\text{C}$ for the LM4818. For a given ambient temperature, T_A , Equation (4) can be used to find the maximum internal power dissipation supported by the IC packaging. If the result of Equation (3) is greater than the result of Equation (4), then decrease the supply voltage, increase the load impedance, or reduce the ambient temperature. For a typical application using the M08A packaged LM4818 with a 5V power supply and an 8 Ω load, the maximum ambient temperature that does not violate the maximum junction temperature is approximately 42°C. It is assumed that a device is a surface mount part operating around the maximum power dissipation point. The assumption that the device is operating around the maximum power dissipation point is incorrect for an 8 Ω load. The maximum power dissipation point occurs when the output power is equal to the maximum power dissipation or 50% efficiency. The LM4818 is not capable of the output power level (633mW) required to operate at the maximum power dissipation point for an 8 Ω load. To find the maximum power dissipation, the graph **Power Dissipation vs. Output Power** must be used. From the graph, the maximum power dissipation for an 8 Ω load and a 5V supply is approximately 575mW. Substituting this value back into equation (4) for P_{DMAX} and using $\theta_{JA} = 170^\circ\text{C/W}$ for the M08A package, the maximum ambient temperature is 52°C. Refer to the **Typical Performance Characteristics** curves for power dissipation information for lower output powers and maximum power dissipation for each package at a given ambient temperature.

POWER SUPPLY BYPASSING

As with any power amplifier, proper supply bypassing is critical for low noise performance and high power supply rejection. The capacitors connected to the bypass and power supply pins should be placed as close to the LM4818 as possible. The capacitor connected between the bypass pin and ground improves the internal bias voltage's stability, producing improved PSRR. The improvements to PSRR increase as the bypass pin capacitor value increases. Typical applications employ a 5V regulator with 10 μF and 0.1 μF filter capacitors that aid in supply stability. Their presence, however, does not eliminate the need for bypassing the supply nodes of the LM4818. The selection of bypass capacitor values, especially C_B , depends on desired PSRR requirements, click and pop performance as explained in the section, **Proper Selection of External Components**, as well as system cost and size constraints.

SHUTDOWN FUNCTION

The voltage applied to the LM4818's SHUTDOWN pin controls the shutdown function. Activate micro-power shutdown by applying V_{DD} to the SHUTDOWN pin. When active, the LM4818's micro-power shutdown feature turns off the amplifier's bias circuitry, reducing the supply current. The logic threshold is typically $1/2V_{DD}$. The low 0.7 μA typical shutdown current is achieved by applying a voltage that is as near as V_{DD} as possible to the SHUTDOWN pin. A voltage that is less than V_{DD} may increase the shutdown current. Avoid intermittent or unexpected micro-power shutdown by ensuring that the SHUTDOWN pin is not left floating but connected to either V_{DD} or GND.

There are a few ways to activate micro-power shutdown. These included using a single-pole, single-throw switch, a microcontroller, or a microprocessor. When using a switch, connect an external 10k Ω to 100k Ω pull-up resistor between the SHUTDOWN pin and V_{DD} . Connect the switch between the SHUTDOWN pin and ground. Select normal amplifier

Application Information (Continued)

operation by closing the switch. Opening the switch connects the shutdown pin to V_{DD} through the pull-up resistor, activating micro-power shutdown. The switch and resistor guarantee that the SHUTDOWN pin will not float. This prevents unwanted state changes. In a system with a microprocessor or a microcontroller, use a digital output to apply the control voltage to the SHUTDOWN pin. Driving the SHUTDOWN pin with active circuitry eliminates the pull-up resistor

PROPER SELECTION OF EXTERNAL COMPONENTS

Optimizing the LM4818's performance requires properly selecting external components. Though the LM4818 operates well when using external components with wide tolerances, best performance is achieved by optimizing component values.

The LM4818 is unity gain stable, giving the designer maximum design flexibility. The gain should be set to no more than a given application requires. This allows the amplifier to achieve minimum THD+N and maximum signal-to-noise ratio. These parameters are compromised as the closed-loop gain increases. However, low gain demands input signals with greater voltage swings to achieve maximum output power. Fortunately, many signal sources such as audio CODECs have outputs of $1V_{RMS}$ (2.83V_{P-P}). Please refer to the **Audio Power Amplifier Design** section for more information on selecting the proper gain.

Another important consideration is the amplifier's close-loop bandwidth. To a large extent, the bandwidth is dictated by the choice of external components shown in *Figure 1*. The input coupling capacitor, C_i , forms a first order high pass filter that limits low frequency response. This value should be chosen based on needed frequency response for a few distinct reasons discussed below

Input Capacitor Value Selection

Amplifying the lowest audio frequencies requires a high value input coupling capacitor (C_i in *Figure 1*). A high value capacitor can be expensive and may compromise space efficiency in portable designs. In many cases the speakers used in portable systems, whether internal or external, have little ability to reproduce signals below 150Hz. Applications using speakers with limited frequency response reap little improvement by using a large input capacitor.

Besides affecting system cost and size, C_i has an effect on the LM4818's click and pop performance. When the supply voltage is first applied, a transient (pop) is created as the charge on the input capacitor changes from zero to a quiescent state. The magnitude of the pop is directly proportional to the input capacitor's value. Higher value capacitors need more time to reach a quiescent DC voltage (usually $1/2 V_{DD}$) when charged with a fixed current. The amplifier's output charges the input capacitor through the feedback resistor, R_F . Thus, selecting an input capacitor value that is no higher than necessary to meet the desired -3dB frequency can minimize pops.

As shown in *Figure 1*, the input resistor (R_i) and the input capacitor, C_i produce a -3dB high pass filter cutoff frequency that is found using Equation (5).

$$f_{-3dB} = 1/(2 \pi R_i C_i) \text{ (Hz)} \quad (5)$$

As an example when using a speaker with a low frequency limit of 150Hz, C_i , using Equation (5) is 0.063 μ F. The 0.39 μ F

C_i shown in *Figure 1* allows the LM4818 to drive a high efficiency, full range speaker whose response extends down to 20Hz.

Besides optimizing the input capacitor value, the bypass capacitor value, C_B requires careful consideration. The bypass capacitor's value is the most critical to minimizing turn-on pops because it determines how fast the LM4818 turns on. The slower the LM4818's outputs ramp to their quiescent DC voltage (nominally $1/2V_{DD}$), the smaller the turn-on pop. While the device will function properly (no oscillations or motorboating), with C_B less than 1.0 μ F, the device will be much more susceptible to turn-on clicks and pops. Thus, a value of C_B equal to or greater than 1.0 μ F is recommended in all but the most cost sensitive designs.

Bypass Capacitor Value Selection

Besides minimizing the input capacitor size, careful consideration should be paid to the value of C_B , the capacitor connected to the BYPASS pin. Since C_B determines how fast the LM4818 settles to quiescent operation, its value is critical when minimizing turn-on pops. The slower the LM4818's outputs ramp to their quiescent DC voltage (nominally $1/2V_{DD}$), the smaller the turn-on pop. Choosing C_B equal to 1.0 μ F along with a small value of C_i (in the range of 0.1 μ F to 0.39 μ F) produces a click-less and pop-less shutdown function. As discussed above, choosing C_i no larger than necessary for the desired bandwidth helps minimize clicks and pops. If using the optional capacitor, C_{B2} , the total capacitance seen at the BYPASS pin is $C_B + C_{B2}$. When using the values shown in *Figure 1*, **Typical Audio Amplifier Application Circuit**, for C_B and C_{B2} the change in the capacitance seen by the BYPASS pin is not significant relative to capacitor value tolerances.

Optimizing Click and Pop Reduction Performance

The LM4818 contains circuitry that minimizes turn-on and shutdown transients or "clicks and pops". For this discussion, turn on refers to either applying the power or supply voltage or when the shutdown mode is deactivated. While the power supply is ramping to its final value, the LM4818's internal amplifiers are configured as unity gain buffers. An internal current source charges the voltage of the bypass capacitor, C_B , connected to the BYPASS pin in a controlled, linear manner. Ideally, the input and outputs track the voltage charging on the bypass capacitor. The gain of the internal amplifiers remains unity until the bypass capacitor is fully charged to $1/2V_{DD}$. As soon as the voltage on the bypass capacitor is stable, the device becomes fully operational. Although the BYPASS pin current cannot be modified, changing the size of the bypass capacitor, C_B , alters the device's turn-on time and magnitude of "clicks and pops". Increasing the value of C_B reduces the magnitude of turn-on pops. However, this presents a tradeoff: as the size of C_B increases, the turn-on time (T_{on}) increases. There is a linear relationship between the size of C_B and the turn on time. If using the optional capacitor, C_{B2} , the total capacitance seen at the BYPASS pin is C_B and C_{B2} . The total capacitance seen at the BYPASS pin must be considered for the table below and when optimizing click and pop performance. Below are some typical turn-on times for various values of C_B :

Application Information (Continued)

C _B	T _{ON}
0.01μF	20ms
0.1μF	200ms
0.22μF	440ms
0.47μF	940ms
1.0μF	2S

In order to eliminate "clicks and pops", all capacitors must be discharged before turn-on. Rapidly switching V_{DD} may not allow the capacitors to fully discharge, which may cause "clicks and pops".

AUDIO POWER AMPLIFIER DESIGN EXAMPLE

The following are the desired operational parameters:

Given:

Power Output	100mW
Load Impedance	16Ω
Input Level	1Vrms (max)
Input Impedance	20kΩ
Bandwidth	100Hz–20kHz ± 0.25dB

The design begins by specifying the minimum supply voltage necessary to obtain the specified output power. To find this minimum supply voltage, use the **Output Power vs. Supply Voltage** graph in the **Typical Performance Characteristics** section. From the graph for a 16Ω load, (graphs are for 8Ω, 16Ω, and 32Ω loads) the supply voltage for 100mW of output power with 1% THD+N is approximately 3.15 volts.

Additional supply voltage creates the benefit of increased headroom that allows the LM4818 to reproduce peaks in excess of 100mW without output signal clipping or audible distortion. The choice of supply voltage must also not create a situation that violates maximum dissipation as explained above in the **Power Dissipation** section. For example, if a 3.3V supply is chosen for extra headroom then according to Equation (3) the maximum power dissipation point with a 16Ω load is 138mW. Using Equation (4) the maximum ambient temperature is 126°C for the M08A package.

After satisfying the LM4818's power dissipation requirements, the minimum differential gain is found using Equation (6).

$$A_{VD} \geq \sqrt{(P_O R_L)} / (V_{IN}) = V_{orms} / V_{inrms} \quad (6)$$

Thus a minimum gain of 1.27 V/V allows the LM4818 to reach full output swing and maintain low noise and THD+N performance. For this example, let A_{VD} = 1.27. The amplifier's overall gain is set using the input (R_i) and feedback (R_F) resistors. With the desired input impedance set to 20kΩ, the feedback resistor is found using Equation (7).

$$R_F / R_i = A_{VD} / 2 \quad (V/V) \quad (7)$$

The value of R_F is 13kΩ.

The last step in this design example is setting the amplifier's -3dB frequency bandwidth. To achieve the desired ±0.25dB pass band magnitude variation limit, the low frequency response must extend to at least one-fifth the lower bandwidth limit and the high frequency response must extend to at least five times the upper bandwidth limit. The gain variation for both response limits is 0.17dB, well within the ±0.25dB desired limit.

The results are:

$$f_L = 100\text{Hz} / 5 = 20\text{Hz}$$

$$f_H = 20\text{kHz} * 5 = 100\text{kHz}$$

As mentioned in the **External Components** section, R_i and C_i create a high pass filter that sets the amplifier's lower band pass frequency limit. Find the coupling capacitor's value using Equation (8).

$$C_i \geq 1 / (2\pi R_i f_c) \quad (F) \quad (8)$$

C_i ≥ 0.398μF, a standard value of 0.39μF will be used. The product of the desired high frequency cutoff (100kHz in this example) and the differential gain, A_{VD}, determines the upper pass band response limit. With A_{VD} = 1.27 and f_H = 100kHz, the closed-loop gain bandwidth product (GBWP) is 127kHz. This is less than the LM4818's 900kHz GBWP. With this margin the amplifier can be used in designs that require more differential gain while avoiding performance restricting bandwidth limitations.

Application Information (Continued)

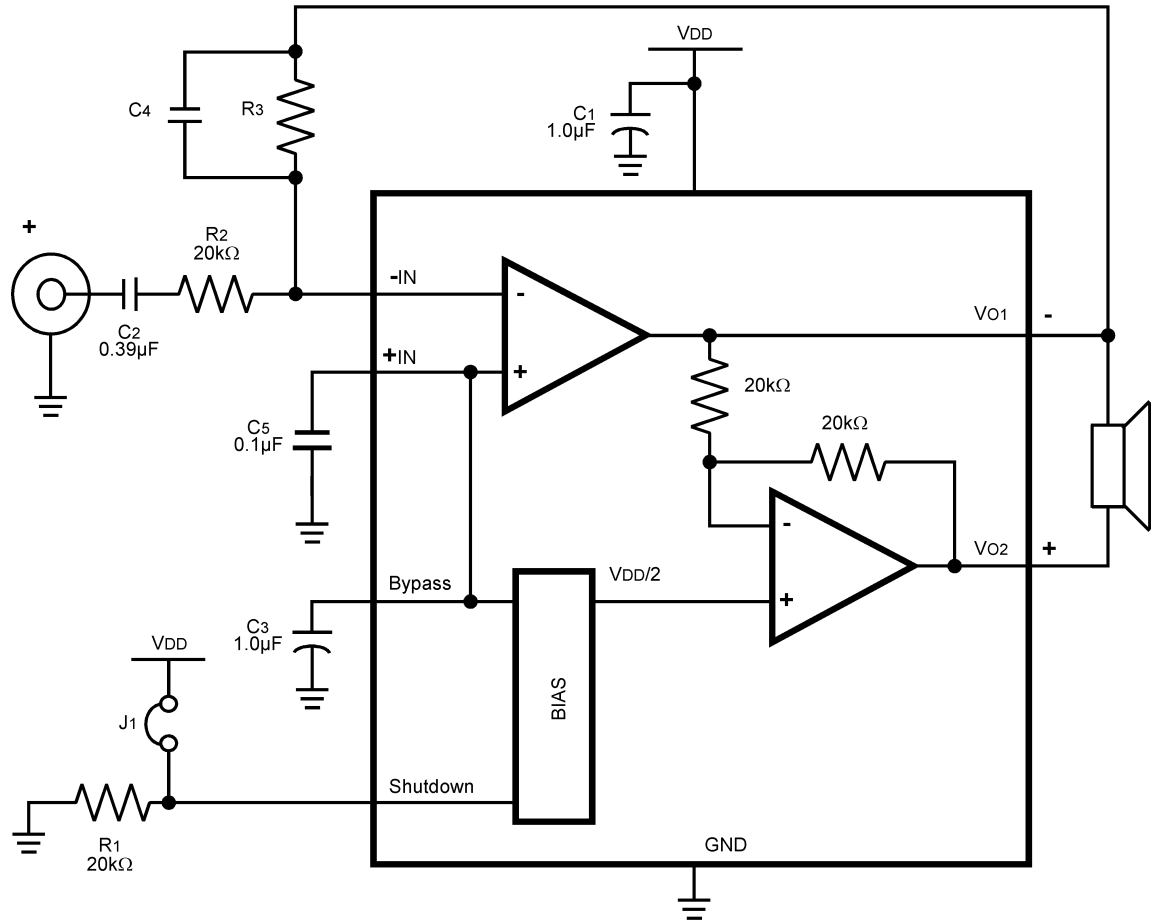

20038975

FIGURE 2. HIGHER GAIN AUDIO AMPLIFIER

The LM4818 is unity-gain stable and requires no external components besides gain-setting resistors, an input coupling capacitor, and proper supply bypassing in the typical application. However, if a closed-loop differential gain of greater than 10 is required, a feedback capacitor (C_4) may be needed as shown in Figure 2 to bandwidth limit the amplifier. This feedback capacitor creates a low pass filter that eliminates possible high frequency oscillations. Care should be

taken when calculating the -3dB frequency in that an incorrect combination of R_3 and C_4 will cause rolloff before 20kHz. A typical combination of feedback resistor and capacitor that will not produce audio band high frequency rolloff is $R_3 = 20\text{k}\Omega$ and $C_4 = 25\text{pF}$. These components result in a -3dB point of approximately 320 kHz. It is not recommended that the feedback resistor and capacitor be used to implement a band limiting filter below 100kHz.

Application Information (Continued)

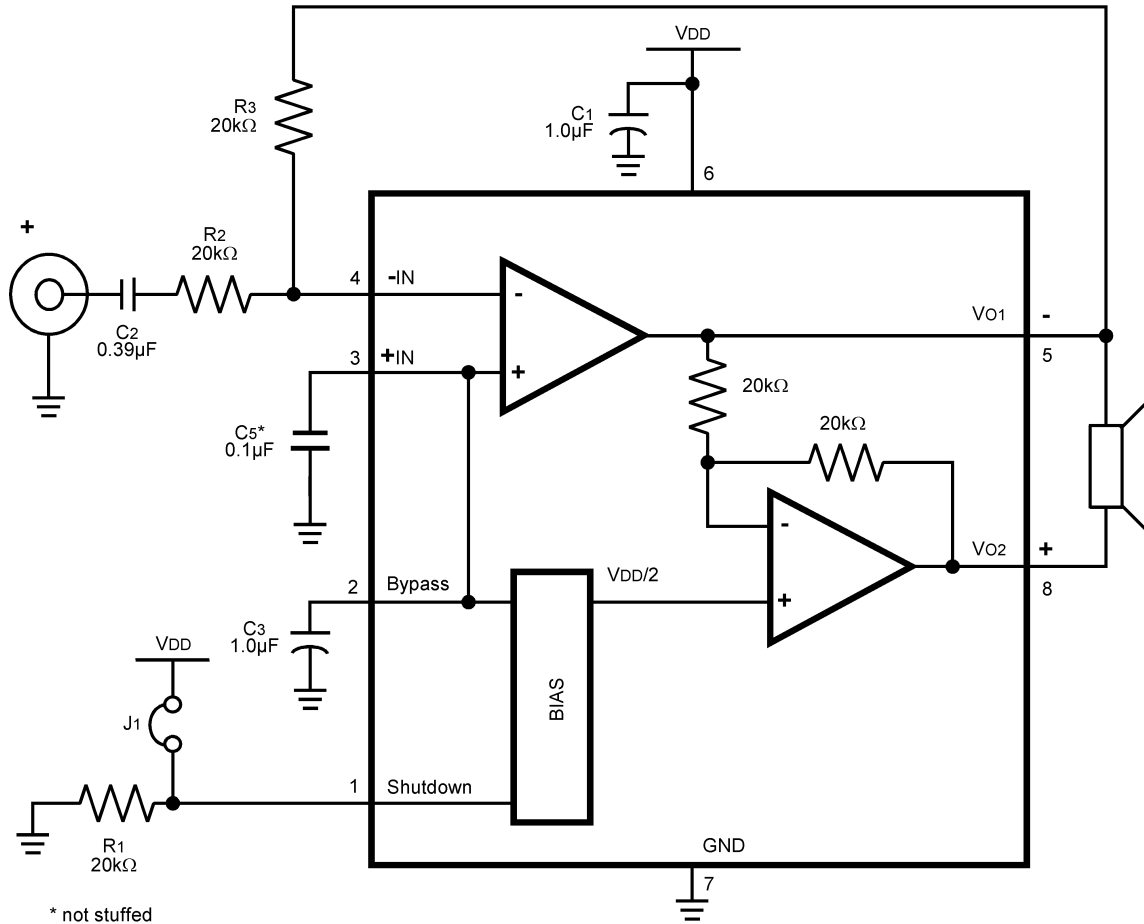

20038976

FIGURE 3. REFERENCE DESIGN BOARD and PCB LAYOUT GUIDELINES

Application Information (Continued)

LM4818 SO DEMO BOARD ARTWORK

Composite View

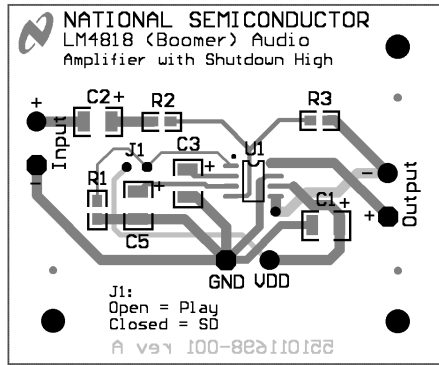

20038977

Silk Screen

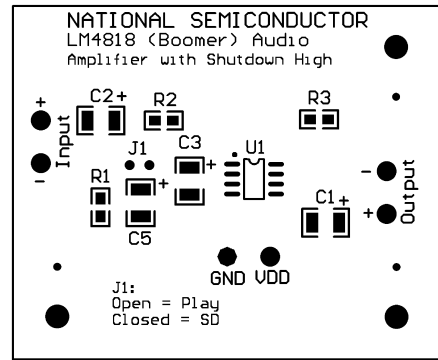

20038978

Top Layer

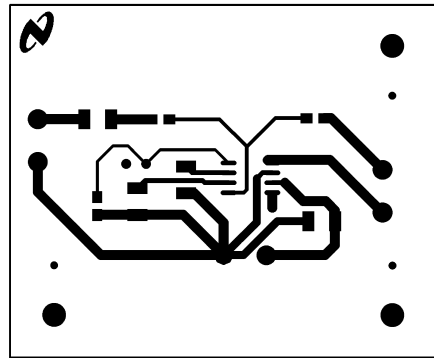

20038979

Bottom Layer

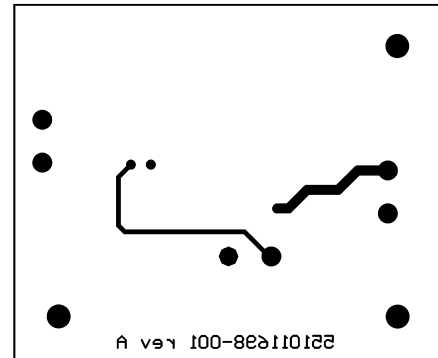

20038980

Mono LM4818 Reference Design Boards Bill of Material for all Demo Boards

Item	Part Number	Part Description	Qty	Ref Designator
1	551011208-001	LM4818 Mono Reference Design Board	1	
10	482911183-001	LM4818 Audio AMP	1	U1
20	151911207-001	Tant Cap 1uF 16V 10	1	C1
21	151911207-002	Cer Cap 0.39uF 50V Z5U 20% 1210	1	C2
25	152911207-001	Tant Cap 1uF 16V 10	1	C3
30	472911207-001	Res 20K Ohm 1/10W 5	3	R1, R2, R3
35	210007039-002	Jumper Header Vertical Mount 2X1 0.100	2	J1

Application Information (Continued)

PCB LAYOUT GUIDELINES

This section provides practical guidelines for mixed signal PCB layout that involves various digital/analog power and ground traces. Designers should note that these are only "rule-of-thumb" recommendations and the actual results will depend heavily on the final layout.

General Mixed Signal Layout Recommendation

Power and Ground Circuits

For two layer mixed signal design, it is important to isolate the digital power and ground trace paths from the analog power and ground trace paths. Star trace routing techniques (bringing individual traces back to a central point rather than daisy chaining traces together in a serial manner) can have a major impact on low level signal performance. Star trace routing refers to using individual traces to feed power and ground to each circuit or even device. This technique will take require a greater amount of design time but will not increase the final price of the board. The only extra parts required will be some jumpers.

Single-Point Power / Ground Connections

The analog power traces should be connected to the digital traces through a single point (link). A "Pi-filter" can be helpful in minimizing high frequency noise coupling between the analog and digital sections. It is further recommended to put digital and analog power traces over the corresponding digital and analog ground traces to minimize noise coupling.

Placement of Digital and Analog Components

All digital components and high-speed digital signals traces should be located as far away as possible from analog components and circuit traces.

Avoiding Typical Design / Layout Problems

Avoid ground loops or running digital and analog traces parallel to each other (side-by-side) on the same PCB layer. When traces must cross over each other do it at 90 degrees. Running digital and analog traces at 90 degrees to each other from the top to the bottom side as much as possible will minimize capacitive noise coupling and cross talk.

Physical Dimensions inches (millimeters) unless otherwise noted

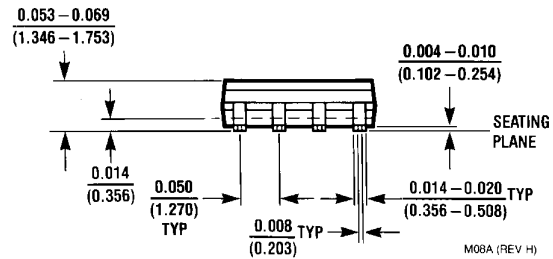
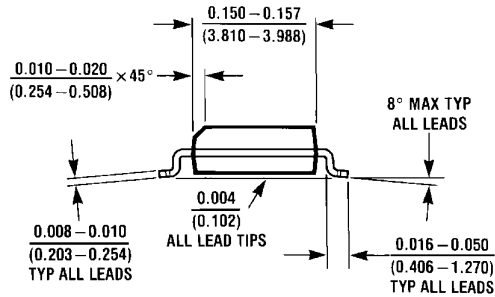
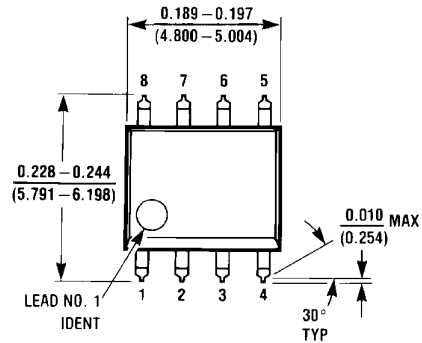

SO
Order Number LM4818M
NS Package Number M08A

National does not assume any responsibility for use of any circuitry described, no circuit patent licenses are implied and National reserves the right at any time without notice to change said circuitry and specifications.

For the most current product information visit us at www.national.com.

LIFE SUPPORT POLICY

NATIONAL'S PRODUCTS ARE NOT AUTHORIZED FOR USE AS CRITICAL COMPONENTS IN LIFE SUPPORT DEVICES OR SYSTEMS WITHOUT THE EXPRESS WRITTEN APPROVAL OF THE PRESIDENT AND GENERAL COUNSEL OF NATIONAL SEMICONDUCTOR CORPORATION. As used herein:

1. Life support devices or systems are devices or systems which, (a) are intended for surgical implant into the body, or (b) support or sustain life, and whose failure to perform when properly used in accordance with instructions for use provided in the labeling, can be reasonably expected to result in a significant injury to the user.
2. A critical component is any component of a life support device or system whose failure to perform can be reasonably expected to cause the failure of the life support device or system, or to affect its safety or effectiveness.

BANNED SUBSTANCE COMPLIANCE

National Semiconductor certifies that the products and packing materials meet the provisions of the Customer Products Stewardship Specification (CSP-9-111C2) and the Banned Substances and Materials of Interest Specification (CSP-9-111S2) and contain no "Banned Substances" as defined in CSP-9-111S2.

 **National Semiconductor**
Americas Customer
Support Center
Email: new.feedback@nsc.com
Tel: 1-800-272-9959

National Semiconductor
Europe Customer Support Center
Fax: +49 (0) 180-530 85 86
Email: europe.support@nsc.com
Deutsch Tel: +49 (0) 69 9508 6208
English Tel: +44 (0) 870 24 0 2171
Français Tel: +33 (0) 1 41 91 8790

National Semiconductor
Asia Pacific Customer
Support Center
Email: ap.support@nsc.com

National Semiconductor
Japan Customer Support Center
Fax: 81-3-5639-7507
Email: jpn.feedback@nsc.com
Tel: 81-3-5639-7560