

MC74VHCT126A

Quad Bus Buffer

with 3-State Control Inputs

The MC74VHCT126A is a high speed CMOS quad bus buffer fabricated with silicon gate CMOS technology. It achieves noninverting high speed operation similar to equivalent Bipolar Schottky TTL while maintaining CMOS low power dissipation.

The MC74VHCT126A requires the 3-state control input (OE) to be set Low to place the output into high impedance.

The VHCT inputs are compatible with TTL levels. This device can be used as a level converter for interfacing 3.3 V to 5.0 V, because it has full 5.0 V CMOS level output swings.

The VHCT126A input structures provide protection when voltages between 0 V and 5.5 V are applied, regardless of the supply voltage. The output structures also provide protection when $V_{CC} = 0$ V. These input and output structures help prevent device destruction caused by supply voltage – input/output voltage mismatch, battery backup, hot insertion, etc.

The internal circuit is composed of three stages, including a buffer output which provides high noise immunity and stable output. The inputs tolerate voltages up to 7.0 V, allowing the interface of 5.0 V systems to 3.0 V systems.

Features

- High Speed: $t_{PD} = 3.8$ ns (Typ) at $V_{CC} = 5.0$ V
- Low Power Dissipation: $I_{CC} = 4.0$ μ A (Max) at $T_A = 25^\circ$ C
- TTL-Compatible Inputs: $V_{IL} = 0.8$ V; $V_{IH} = 2.0$ V
- Power Down Protection Provided on Inputs
- Balanced Propagation Delays
- Designed for 2.0 V to 5.5 V Operating Range
- Low Noise: $V_{OLP} = 0.8$ V (Max)
- Pin and Function Compatible with Other Standard Logic Families
- Latchup Performance Exceeds 300 mA
- ESD Performance: HBM > 2000 V; Machine Model > 200 V
- Chip Complexity: 72 FETs or 18 Equivalent Gates
- Pb-Free Packages are Available*



ON Semiconductor®

<http://onsemi.com>

MARKING DIAGRAMS

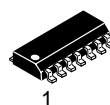

SOIC-14
D SUFFIX
CASE 751A

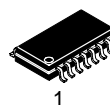
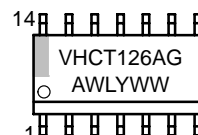

SOEIAJ-14
M SUFFIX
CASE 965

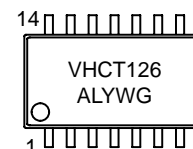

A = Assembly Location
WL, L = Wafer Lot
Y = Year
WW, W = Work Week
G = Pb-Free Package

See Applications Note #AND8004/D for date code and traceability information.

FUNCTION TABLE

| VHCT126A | | |
|----------|----|---------|
| Inputs | | Outputs |
| A | OE | Y |
| H | H | H |
| L | H | L |
| X | L | Z |

ORDERING INFORMATION

See detailed ordering and shipping information in the package dimensions section on page 4 of this data sheet.

*For additional information on our Pb-Free strategy and soldering details, please download the ON Semiconductor Soldering and Mounting Techniques Reference Manual, SOLDERRM/D.

MC74VHCT126A

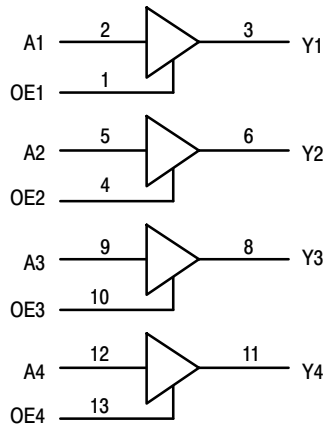

**Figure 1. LOGIC DIAGRAM
Active-High Output Enables**

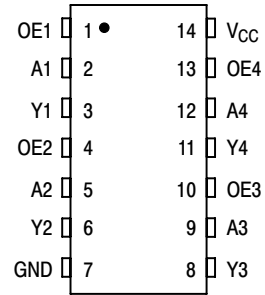

Figure 2. PIN ASSIGNMENT

MAXIMUM RATINGS

| Rating | Symbol | Value | Unit |
|--|-----------|---|------|
| DC Supply Voltage | V_{CC} | - 0.5 to + 7.0 | V |
| DC Input Voltage | V_{in} | - 0.5 to + 7.0 | V |
| DC Output Voltage | V_{out} | - 0.5 to + 7.0 - 0.5 to $V_{CC} + 0.5$ | V |
| Input Diode Current | I_{IK} | - 20 | mA |
| Output Diode Current ($V_{OUT} < GND$; $V_{OUT} > V_{CC}$) | I_{OK} | ± 20 | mA |
| DC Output Current, per Pin | I_{out} | ± 25 | mA |
| DC Supply Current, V_{CC} and GND Pins | I_{CC} | ± 75 | mA |
| Power Dissipation in Still Air, SOIC Packages† TSSOP Package† | P_D | 500 450 | mW |
| Storage Temperature | T_{stg} | - 65 to + 150 | °C |

This device contains protection circuitry to guard against damage due to high static voltages or electric fields. However, precautions must be taken to avoid applications of any voltage higher than maximum rated voltages to this high-impedance circuit. For proper operation, V_{in} and V_{out} should be constrained to the range $GND \leq (V_{in} \text{ or } V_{out}) \leq V_{CC}$. Unused inputs must always be tied to an appropriate logic voltage level (e.g., either GND or V_{CC}). Unused outputs must be left open.

Stresses exceeding Maximum Ratings may damage the device. Maximum Ratings are stress ratings only. Functional operation above the Recommended Operating Conditions is not implied. Extended exposure to stresses above the Recommended Operating Conditions may affect device reliability.

†Derating — SOIC Packages: - 7 mW/°C from 65° to 125°C
TSSOP Package: - 6.1 mW/°C from 65° to 125°C

RECOMMENDED OPERATING CONDITIONS

| Parameter | Symbol | Min | Max | Unit |
|--------------------------|------------|--------|-----------------|------|
| DC Supply Voltage | V_{CC} | 4.5 | 5.5 | V |
| DC Input Voltage | V_{in} | 0 | 5.5 | V |
| DC Output Voltage | V_{out} | 0 0 | 5.5 V_{CC} | V |
| Operating Temperature | T_A | - 40 | + 85 | °C |
| Input Rise and Fall Time | t_r, t_f | 0 | 20 | ns/V |

MC74VHCT126A

DC ELECTRICAL CHARACTERISTICS

| Parameter | Test Conditions | Symbol | V _{CC} (V) | T _A = 25°C | | | T _A ≤ 85°C | | T _A ≤ 125°C | | Unit |
|---|--|------------------|---------------------|-----------------------|------------|--------------------|-----------------------|--------------------|------------------------|-----|------|
| | | | | Min | Typ | Max | Min | Max | Min | Max | |
| Minimum High-Level Input Voltage | | V _{IH} | 3.0 4.5 5.5 | 1.2 2.0 2.0 | | | 1.2 2.0 2.0 | | 1.2 2.0 2.0 | V | |
| Maximum Low-Level Input Voltage | | V _{IL} | 3.0 4.5 5.5 | | | 0.53 0.8 0.8 | | 0.53 0.8 0.8 | 0.53 0.8 0.8 | V | |
| Minimum High-Level Output Voltage V _{IN} = V _{IH} or V _{IL} | V _{IN} = V _{IH} or V _{IL} I _{OH} = -50 μA | V _{OH} | 3.0 4.5 | 2.9 4.4 | 3.0 4.5 | | 2.9 4.4 | | 2.9 4.4 | V | |
| | V _{IN} = V _{IH} or V _{IL} I _{OH} = -4.0 mA I _{OH} = -8.0 mA | | 3.0 4.5 | 2.58 3.94 | | | 2.48 3.80 | | 2.34 3.66 | | |
| Maximum Low-Level Output Voltage V _{IN} = V _{IH} or V _{IL} | V _{IN} = V _{IH} or V _{IL} I _{OL} = 50 μA | V _{OL} | 3.0 4.5 | | 0.0 0.0 | 0.1 0.1 | | 0.1 0.1 | 0.1 0.1 | V | |
| | V _{IN} = V _{IH} or V _{IL} I _{OL} = 4.0 mA I _{OL} = 8.0 mA | | 3.0 4.5 | | | 0.36 0.36 | | 0.44 0.44 | 0.52 0.52 | | |
| Maximum Input Leakage Current | V _{IN} = 5.5 V or GND | I _{IN} | 0 to 5.5 | | | ±0.1 | | ±1.0 | ±1.0 | μA | |
| Maximum Quiescent Supply Current | V _{IN} = V _{CC} or GND | I _{CC} | 5.5 | | | 2.0 | | 20 | 40 | μA | |
| Quiescent Supply Current | Input: V _{IN} = 3.4 V | I _{CCT} | 5.5 | | | 1.35 | | 1.50 | 1.65 | mA | |
| Maximum 3-State Leakage Current | V _{IN} = V _{IH} or V _I V _{OUT} = V _{CC} or GND | I _{OZ} | 5.5 | | | ±0.2 5 | | ±2.5 | ±2.5 | μA | |
| Output Leakage Current | V _{OUT} = 5.5 V | I _{OPD} | 0.0 | | | 0.5 | | 5.0 | 10 | μA | |

AC ELECTRICAL CHARACTERISTICS (Input t_r = t_f = 3.0 ns)

| Parameter | Test Conditions | Symbol | T _A = 25°C | | | T _A ≤ 85°C | | T _A ≤ 125°C | | Unit |
|---|--|--|--|------------|-------------|-----------------------|-------------|------------------------|--------------|------|
| | | | Min | Typ | Max | Min | Max | Min | Max | |
| Maximum Propagation Delay, A to Y | V _{CC} = 3.3 ± 0.3 V C _L = 15 pF C _L = 50 pF | t _{PLH} , t _{PHL} | | 5.6 8.1 | 8.0 11.5 | 1.0 1.0 | 9.5 13.0 | | 12.0 16.0 | ns |
| | V _{CC} = 5.0 ± 0.5 V C _L = 15 pF C _L = 50 pF | | | 3.8 5.3 | 5.5 7.5 | 1.0 1.0 | 6.5 8.5 | | 8.5 10.5 | |
| Maximum Output Enable Time, OE to Y | V _{CC} = 3.3 ± 0.3 V C _L = 15 pF R _L = 1.0 kΩ C _L = 50 pF | t _{PZL} , t _{PZH} | | 5.4 7.9 | 8.0 11.5 | 1.0 1.0 | 9.5 13.0 | | 11.5 15.0 | ns |
| | V _{CC} = 5.0 ± 0.5 V C _L = 15 pF R _L = 1.0 kΩ C _L = 50 pF | | | 3.6 5.1 | 5.1 7.1 | 1.0 1.0 | 6.0 8.0 | | 7.5 9.5 | |
| Maximum Output Disable Time, OE to Y | V _{CC} = 3.3 ± 0.3 V C _L = 50 pF R _L = 1.0 kΩ | t _{PLZ} , t _{PHZ} | | 9.5 | 13.2 | 1.0 | 15.0 | | 18.0 | ns |
| | V _{CC} = 5.0 ± 0.5 V C _L = 50 pF R _L = 1.0 kΩ | | | 6.1 | 8.8 | 1.0 | 10.0 | | 12.0 | |
| Output-to-Output Skew | V _{CC} = 3.3 ± 0.3 V C _L = 50 pF (Note 1) | t _{OSLH} , t _{OSHL} | | | 1.5 | | 1.5 | | 2.0 | ns |
| | V _{CC} = 5.0 ± 0.5 V C _L = 50 pF (Note 1) | | | | 1.0 | | 1.0 | | 1.5 | |
| Maximum Input Capacitance | | C _{in} | | 4 | 10 | | 10 | | 10 | pF |
| Maximum Three-State Output Capacitance (Output in High Impedance State) | | C _{out} | | 6 | | | | | | pF |
| Power Dissipation Capacitance (Note 2) | | C _{PD} | Typical @ 25°C, V _{CC} = 5.0V | | | | | | | pF |
| | | | 15 | | | | | | | |

- Parameter guaranteed by design. t_{OSLH} = |t_{PLHm} - t_{PLHn}|, t_{OSHL} = |t_{PHLm} - t_{PHLn}|.
- C_{PD} is defined as the value of the internal equivalent capacitance which is calculated from the operating current consumption without load. Average operating current can be obtained by the equation: I_{CC(OPR)} = C_{PD} • V_{CC} • f_{in} + I_{CC}/4 (per buffer). C_{PD} is used to determine the no-load dynamic power consumption; P_D = C_{PD} • V_{CC}² • f_{in} + I_{CC} • V_{CC}.

MC74VHCT126A

NOISE CHARACTERISTICS (Input $t_r = t_f = 3.0\text{ns}$, $C_L = 50\text{pF}$, $V_{CC} = 5.0\text{V}$)

| Characteristic | Symbol | $T_A = 25^\circ\text{C}$ | | Unit |
|--|-----------|--------------------------|------|------|
| | | Typ | Max | |
| Quiet Output Maximum Dynamic V_{OL} | V_{OLP} | 0.3 | 0.8 | V |
| Quiet Output Minimum Dynamic V_{OL} | V_{OLV} | -0.3 | -0.8 | V |
| Minimum High Level Dynamic Input Voltage | V_{IHD} | | 3.5 | V |
| Maximum Low Level Dynamic Input Voltage | V_{ILD} | | 1.5 | V |

SWITCHING WAVEFORMS

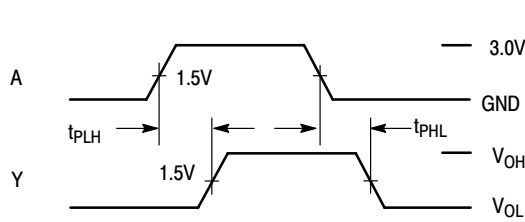

Figure 3.

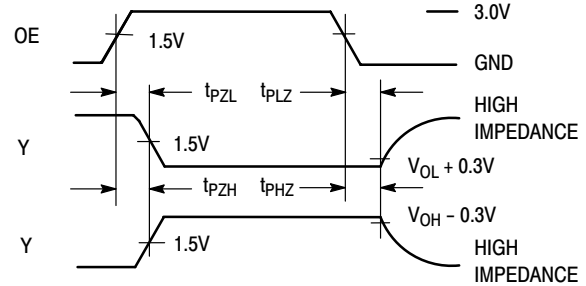
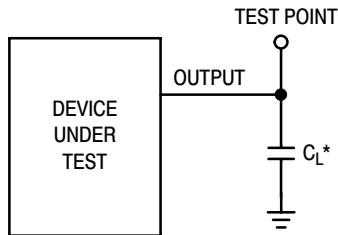
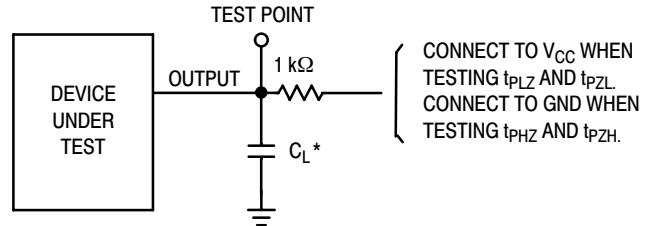

Figure 4.



*Includes all probe and jig capacitance

Figure 5. Test Circuit



*Includes all probe and jig capacitance

Figure 6. Test Circuit

ORDERING INFORMATION

| Device | Package | Shipping† |
|------------------|---------------------|--------------------|
| MC74VHCT126ADR2 | SOIC-14 | 2500 / Tape & Reel |
| MC74VHCT126ADR2G | SOIC-14 (Pb-Free) | |
| MC74VHCT126AM | SOEIAJ-14 | 50 Units / Rail |
| MC74VHCT126AMG | SOEIAJ-14 (Pb-Free) | |
| MC74VHCT126AMEL | SOEIAJ-14 | 2000 / Tape & Reel |
| MC74VHCT126AMELG | SOEIAJ-14 (Pb-Free) | |

†For information on tape and reel specifications, including part orientation and tape sizes, please refer to our Tape and Reel Packaging Specifications Brochure, BRD8011/D.

MC74VHCT126A

PACKAGE DIMENSIONS

SOIC-14
CASE 751A-03
ISSUE G

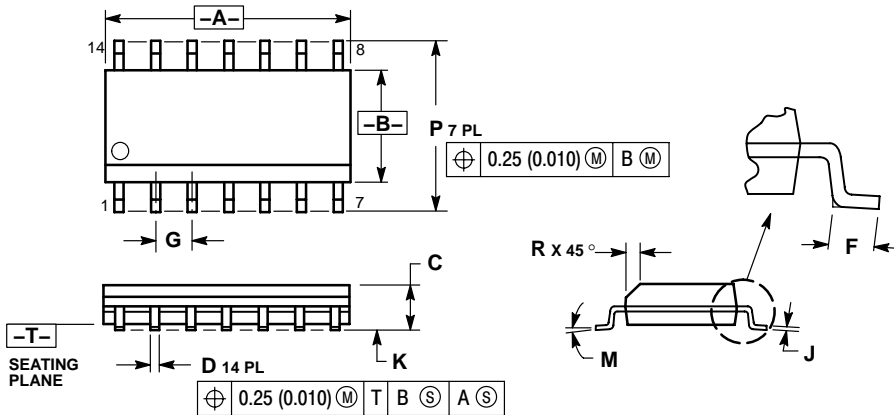

NOTES:

1. DIMENSIONING AND TOLERANCING PER ANSI Y14.5M, 1982.
2. CONTROLLING DIMENSION: MILLIMETER.
3. DIMENSIONS A AND B DO NOT INCLUDE MOLD PROTRUSION.
4. MAXIMUM MOLD PROTRUSION 0.15 (0.006) PER SIDE.
5. DIMENSION D DOES NOT INCLUDE DAMBAR PROTRUSION. ALLOWABLE DAMBAR PROTRUSION SHALL BE 0.127 (0.005) TOTAL IN EXCESS OF THE D DIMENSION AT MAXIMUM MATERIAL CONDITION.

| DIM | MILLIMETERS | | INCHES | |
|-----|-------------|------|-----------|-------|
| | MIN | MAX | MIN | MAX |
| A | 8.55 | 8.75 | 0.337 | 0.344 |
| B | 3.80 | 4.00 | 0.150 | 0.157 |
| C | 1.35 | 1.75 | 0.054 | 0.068 |
| D | 0.35 | 0.49 | 0.014 | 0.019 |
| F | 0.40 | 1.25 | 0.016 | 0.049 |
| G | 1.27 BSC | | 0.050 BSC | |
| J | 0.19 | 0.25 | 0.008 | 0.009 |
| K | 0.10 | 0.25 | 0.004 | 0.009 |
| M | 0° | 7° | 0° | 7° |
| P | 5.80 | 6.20 | 0.228 | 0.244 |
| R | 0.25 | 0.50 | 0.010 | 0.019 |

SOEIAJ-14
CASE 965-01
ISSUE A

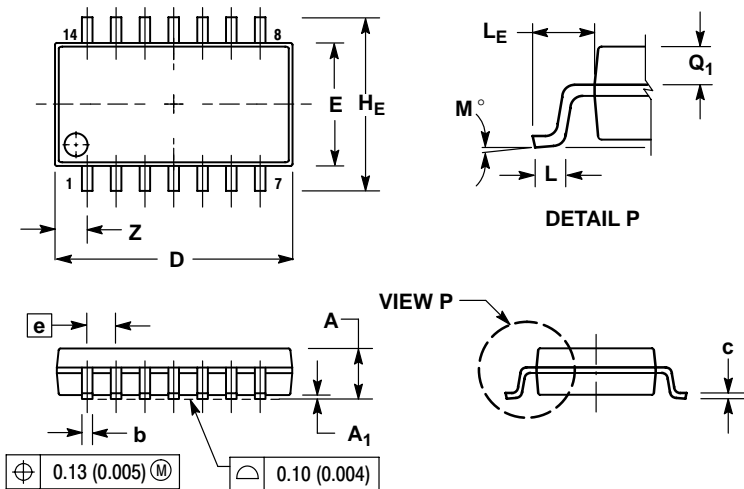

NOTES:

1. DIMENSIONING AND TOLERANCING PER ANSI Y14.5M, 1982.
2. CONTROLLING DIMENSION: MILLIMETER.
3. DIMENSIONS D AND E DO NOT INCLUDE MOLD FLASH OR PROTRUSIONS AND ARE MEASURED AT THE PARTING LINE. MOLD FLASH OR PROTRUSIONS SHALL NOT EXCEED 0.15 (0.006) PER SIDE.
4. TERMINAL NUMBERS ARE SHOWN FOR REFERENCE ONLY.
5. THE LEAD WIDTH DIMENSION (b) DOES NOT INCLUDE DAMBAR PROTRUSION. ALLOWABLE DAMBAR PROTRUSION SHALL BE 0.08 (0.003) TOTAL IN EXCESS OF THE LEAD WIDTH DIMENSION AT MAXIMUM MATERIAL CONDITION. DAMBAR CANNOT BE LOCATED ON THE LOWER RADIUS OR THE FOOT. MINIMUM SPACE BETWEEN PROTRUSIONS AND ADJACENT LEAD TO BE 0.46 (0.018).

| DIM | MILLIMETERS | | INCHES | |
|----------------|-------------|-------|-----------|-------|
| | MIN | MAX | MIN | MAX |
| A | --- | 2.05 | --- | 0.081 |
| A ₁ | 0.05 | 0.20 | 0.002 | 0.008 |
| b | 0.35 | 0.50 | 0.014 | 0.020 |
| c | 0.10 | 0.20 | 0.004 | 0.008 |
| D | 9.90 | 10.50 | 0.390 | 0.413 |
| E | 5.10 | 5.45 | 0.201 | 0.215 |
| e | 1.27 BSC | | 0.050 BSC | |
| H _E | 7.40 | 8.20 | 0.291 | 0.323 |
| 0.50 | 0.50 | 0.85 | 0.020 | 0.033 |
| L _E | 1.10 | 1.50 | 0.043 | 0.059 |
| M | 0° | 10° | 0° | 10° |
| Q ₁ | 0.70 | 0.90 | 0.028 | 0.035 |
| Z | --- | 1.42 | --- | 0.056 |

MC74VHCT126A

ON Semiconductor and  are registered trademarks of Semiconductor Components Industries, LLC (SCILLC). SCILLC reserves the right to make changes without further notice to any products herein. SCILLC makes no warranty, representation or guarantee regarding the suitability of its products for any particular purpose, nor does SCILLC assume any liability arising out of the application or use of any product or circuit, and specifically disclaims any and all liability, including without limitation special, consequential or incidental damages. "Typical" parameters which may be provided in SCILLC data sheets and/or specifications can and do vary in different applications and actual performance may vary over time. All operating parameters, including "Typicals" must be validated for each customer application by customer's technical experts. SCILLC does not convey any license under its patent rights nor the rights of others. SCILLC products are not designed, intended, or authorized for use as components in systems intended for surgical implant into the body, or other applications intended to support or sustain life, or for any other application in which the failure of the SCILLC product could create a situation where personal injury or death may occur. Should Buyer purchase or use SCILLC products for any such unintended or unauthorized application, Buyer shall indemnify and hold SCILLC and its officers, employees, subsidiaries, affiliates, and distributors harmless against all claims, costs, damages, and expenses, and reasonable attorney fees arising out of, directly or indirectly, any claim of personal injury or death associated with such unintended or unauthorized use, even if such claim alleges that SCILLC was negligent regarding the design or manufacture of the part. SCILLC is an Equal Opportunity/Affirmative Action Employer. This literature is subject to all applicable copyright laws and is not for resale in any manner.

PUBLICATION ORDERING INFORMATION

LITERATURE FULFILLMENT:

Literature Distribution Center for ON Semiconductor
P.O. Box 61312, Phoenix, Arizona 85082-1312 USA

Phone: 480-829-7710 or 800-344-3860 Toll Free USA/Canada

Fax: 480-829-7709 or 800-344-3867 Toll Free USA/Canada

Email: orderlit@onsemi.com

N. American Technical Support: 800-282-9855 Toll Free
USA/Canada

Japan: ON Semiconductor, Japan Customer Focus Center
2-9-1 Kamimeguro, Meguro-ku, Tokyo, Japan 153-0051
Phone: 81-3-5773-3850

ON Semiconductor Website: <http://onsemi.com>

Order Literature: <http://www.onsemi.com/litorder>

For additional information, please contact your
local Sales Representative.