

MC74LVX244

Octal Bus Buffer

With 5V-Tolerant Inputs

The MC74LVX244 is an advanced high speed CMOS non-inverting 3-state octal bus buffer and has two active low output enables. It is also designed to work with 3-state memory address drivers, etc. The inputs tolerate voltages up to 7.0 V, allowing the interface of 5.0 V systems to 3.0 V systems.

Features

- High Speed: $t_{PD} = 4.7$ ns (Typ) at $V_{CC} = 3.3$ V
- Low Power Dissipation: $I_{CC} = 4$ μ A (Max) at $T_A = 25^\circ$ C
- Power Down Protection Provided on Inputs
- Balanced Propagation Delays
- Low Noise: $V_{OLP} = 0.8$ V (Max)
- Pin and Function Compatible with Other Standard Logic Families
- Latchup Performance Exceeds 300 mA
- ESD Performance:
 - Human Body Model > 2000 V;
 - Machine Model > 200 V
- These Devices are Pb-Free and are RoHS Compliant

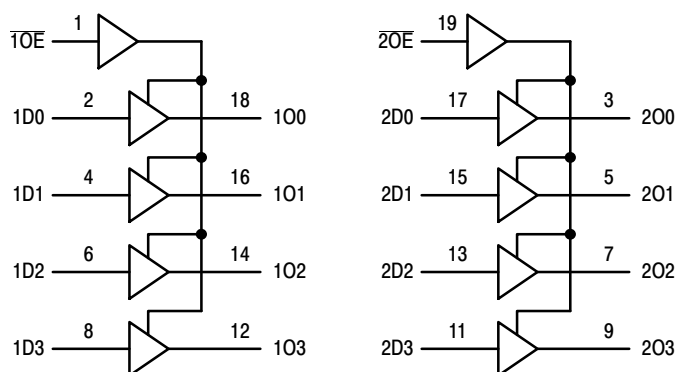

Figure 1. Logic Diagram

PIN NAMES

| Pins | Function |
|------------------|----------------------|
| \overline{nOE} | Output Enable Inputs |
| 1Dn, 2Dn | Data Inputs |
| 1On, 2On | 3-State Outputs |

FUNCTION TABLE

| INPUTS | | OUTPUTS |
|----------------------------------|----------|----------|
| $\overline{1OE}, \overline{2OE}$ | 1Dn, 2Dn | 1On, 2On |
| L | L | L |
| L | H | H |
| H | X | Z |



ON Semiconductor®

<http://onsemi.com>

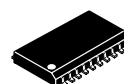

SOIC-20
DW SUFFIX
CASE 751D



TSSOP-20
DT SUFFIX
CASE 948E

PIN ASSIGNMENT

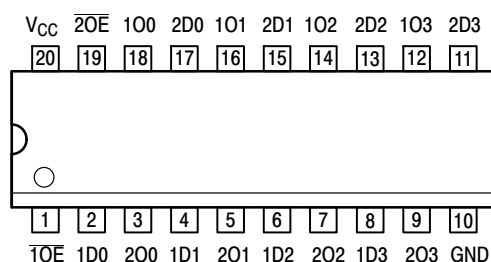

20-Lead (Top View)

MARKING DIAGRAMS

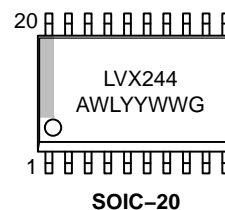

SOIC-20

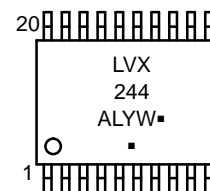

TSSOP-20

LVX244 = Specific Device Code
A = Assembly Location
WL, L = Wafer Lot
Y = Year
WW, W = Work Week
G or \blacksquare = Pb-Free Package

(Note: Microdot may be in either location)

ORDERING INFORMATION

See detailed ordering and shipping information in the package dimensions section on page 4 of this data sheet.

MC74LVX244

MAXIMUM RATINGS

| Symbol | Parameter | Value | Unit |
|-----------|--|------------------------|------|
| V_{CC} | DC Supply Voltage | -0.5 to +7.0 | V |
| V_{in} | DC Input Voltage | -0.5 to +7.0 | V |
| V_{out} | DC Output Voltage | -0.5 to $V_{CC} + 0.5$ | V |
| I_{IK} | Input Diode Current | -20 | mA |
| I_{OK} | Output Diode Current | ±20 | mA |
| I_{out} | DC Output Current, per Pin | ±25 | mA |
| I_{CC} | DC Supply Current, V_{CC} and GND Pins | ±75 | mA |
| P_D | Power Dissipation | 180 | mW |
| T_{stg} | Storage Temperature | -65 to +150 | °C |

Stresses exceeding those listed in the Maximum Ratings table may damage the device. If any of these limits are exceeded, device functionality should not be assumed, damage may occur and reliability may be affected.

RECOMMENDED OPERATING CONDITIONS

| Symbol | Parameter | Min | Max | Unit |
|---------------------|--|-----|----------|------|
| V_{CC} | DC Supply Voltage | 2.0 | 3.6 | V |
| V_{in} | DC Input Voltage | 0 | 5.5 | V |
| V_{out} | DC Output Voltage | 0 | V_{CC} | V |
| T_A | Operating Temperature, All Package Types | -40 | +85 | °C |
| $\Delta t/\Delta V$ | Input Rise and Fall Time | 0 | 100 | ns/V |

Functional operation above the stresses listed in the Recommended Operating Ranges is not implied. Extended exposure to stresses beyond the Recommended Operating Ranges limits may affect device reliability.

DC ELECTRICAL CHARACTERISTICS

| Symbol | Parameter | Test Conditions | V_{CC} V | $T_A = 25^\circ\text{C}$ | | | $T_A = -40 \text{ to } 85^\circ\text{C}$ | | Unit |
|----------|--|--|---------------|--------------------------|-----|-----------|--|------|------|
| | | | | Min | Typ | Max | Min | Max | |
| V_{IH} | High-Level Input Voltage | | 2.0 | 1.5 | | | 1.5 | | V |
| | | | 3.0 | 2.0 | | | 2.0 | | |
| | | | 3.6 | 2.4 | | | 2.4 | | |
| V_{IL} | Low-Level Input Voltage | | 2.0 | | | 0.5 | | 0.5 | V |
| | | | 3.0 | | | 0.8 | | 0.8 | |
| | | | 3.6 | | | 0.8 | | 0.8 | |
| V_{OH} | High-Level Output Voltage ($V_{in} = V_{IH}$ or V_{IL}) | $I_{OH} = -50\mu\text{A}$ $I_{OH} = -50\mu\text{A}$ $I_{OH} = -4\text{mA}$ | 2.0 | 1.9 | 2.0 | | 1.9 | | V |
| | | | 3.0 | 2.9 | 3.0 | | 2.9 | | |
| | | | 3.0 | 2.58 | | | 2.48 | | |
| V_{OL} | Low-Level Output Voltage ($V_{in} = V_{IH}$ or V_{IL}) | $I_{OL} = 50\mu\text{A}$ $I_{OL} = 50\mu\text{A}$ $I_{OL} = 4\text{mA}$ | 2.0 | | 0.0 | 0.1 | | 0.1 | V |
| | | | 3.0 | | 0.0 | 0.1 | | 0.1 | |
| | | | 3.0 | | | 0.36 | | 0.44 | |
| I_{in} | Input Leakage Current | $V_{in} = 5.5\text{V}$ or GND | 3.6 | | | ±0.1 | | ±1.0 | μA |
| I_{OZ} | Maximum 3-State Leakage Current | $V_{in} = V_{IL}$ or V_{IH} $V_{out} = V_{CC}$ or GND | 3.6 | | | ±0.2 5 | | ±2.5 | μA |
| I_{CC} | Quiescent Supply Current | $V_{in} = V_{CC}$ or GND | 3.6 | | | 4.0 | | 40.0 | μA |

Product parametric performance is indicated in the Electrical Characteristics for the listed test conditions, unless otherwise noted. Product performance may not be indicated by the Electrical Characteristics if operated under different conditions.

MC74LVX244

AC ELECTRICAL CHARACTERISTICS (Input $t_r = t_f = 3.0\text{ns}$)

| Symbol | Parameter | Test Conditions | $T_A = 25^\circ\text{C}$ | | | $T_A = -40 \text{ to } 85^\circ\text{C}$ | | Unit |
|----------------------------|--|--|--------------------------|------|------|--|------|------|
| | | | Min | Typ | Max | Min | Max | |
| t_{PLH} , t_{PHL} | Propagation Delay Input to Output | $V_{CC} = 2.7\text{V}$ $C_L = 15\text{pF}$ | | 6.1 | 11.4 | 1.0 | 13.5 | ns |
| | | $C_L = 50\text{pF}$ | | 8.6 | 14.9 | 1.0 | 17.0 | |
| | | $V_{CC} = 3.3 \pm 0.3\text{V}$ $C_L = 15\text{pF}$ | | 4.7 | 7.1 | 1.0 | 8.5 | |
| | | $C_L = 50\text{pF}$ | | 7.2 | 10.6 | 1.0 | 12.0 | |
| t_{PZL} , t_{PZH} | Output Enable Time to High and Low Level | $V_{CC} = 2.7\text{V}$ $C_L = 15\text{pF}$ | | 7.1 | 13.8 | 1.0 | 16.5 | ns |
| | | $R_L = 1\text{k}\Omega$ $C_L = 50\text{pF}$ | | 9.6 | 17.3 | 1.0 | 20.0 | |
| | | $V_{CC} = 3.3 \pm 0.3\text{V}$ $C_L = 15\text{pF}$ | | 5.5 | 8.8 | 1.0 | 10.5 | |
| | | $R_L = 1\text{k}\Omega$ $C_L = 50\text{pF}$ | | 8.0 | 12.3 | 1.0 | 14.0 | |
| t_{PLZ} , t_{PHZ} | Output Disable Time From High and Low Level | $V_{CC} = 2.7\text{V}$ $C_L = 50\text{pF}$ | | 11.6 | 16.0 | 1.0 | 19.0 | ns |
| | | $R_L = 1\text{k}\Omega$ | | | | | | |
| | | $V_{CC} = 3.3 \pm 0.3\text{V}$ $C_L = 50\text{pF}$ | | 9.7 | 11.4 | 1.0 | 13.0 | |
| | | $R_L = 1\text{k}\Omega$ | | | | | | |
| t_{OSHL} , t_{OSLH} | Output-to-Output Skew (Note 1) | $V_{CC} = 2.7\text{V}$ $C_L = 50\text{pF}$ | | | 1.5 | | 1.5 | ns |
| | | $V_{CC} = 3.3 \pm 0.3\text{V}$ $C_L = 50\text{pF}$ | | | 1.5 | | 1.5 | |

1. Skew is defined as the absolute value of the difference between the actual propagation delay for any two separate outputs of the same device. The specification applies to any outputs switching in the same direction, either HIGH-to-LOW (t_{OSHL}) or LOW-to-HIGH (t_{OSLH}); parameter guaranteed by design.

CAPACITIVE CHARACTERISTICS

| Symbol | Parameter | $T_A = 25^\circ\text{C}$ | | | $T_A = -40 \text{ to } 85^\circ\text{C}$ | | Unit |
|-----------|--|--------------------------|-----|-----|--|-----|------|
| | | Min | Typ | Max | Min | Max | |
| C_{in} | Input Capacitance | | 4 | 10 | | 10 | pF |
| C_{out} | Maximum Three-State Output Capacitance | | 6 | | | | pF |
| C_{PD} | Power Dissipation Capacitance (Note 2) | | 19 | | | | pF |

2. C_{PD} is defined as the value of the internal equivalent capacitance which is calculated from the operating current consumption without load. Average operating current can be obtained by the equation: $I_{CC(OPR)} = C_{PD} \cdot V_{CC} \cdot f_{in} + I_{CC}/8$ (per bit). C_{PD} is used to determine the no-load dynamic power consumption; $P_D = C_{PD} \cdot V_{CC}^2 \cdot f_{in} + I_{CC} \cdot V_{CC}$.

NOISE CHARACTERISTICS (Input $t_r = t_f = 3.0\text{ns}$, $C_L = 50\text{pF}$, $V_{CC} = 3.3\text{V}$, Measured in SOIC Package)

| Symbol | Characteristic | $T_A = 25^\circ\text{C}$ | | Unit |
|-----------|--|--------------------------|------|------|
| | | Typ | Max | |
| V_{OLP} | Quiet Output Maximum Dynamic V_{OL} | 0.5 | 0.8 | V |
| V_{OLV} | Quiet Output Minimum Dynamic V_{OL} | -0.5 | -0.8 | V |
| V_{IHD} | Minimum High Level Dynamic Input Voltage | | 2.0 | V |
| V_{ILD} | Maximum Low Level Dynamic Input Voltage | | 0.8 | V |

MC74LVX244

SWITCHING WAVEFORMS

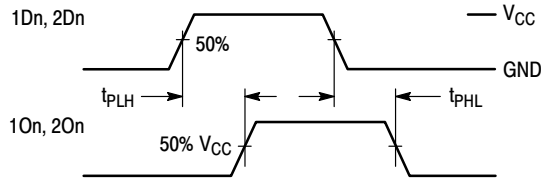

Figure 2.

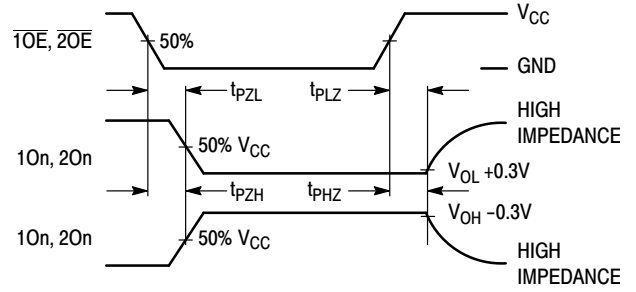
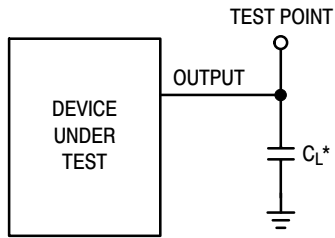

Figure 3.

TEST CIRCUITS



*Includes all probe and jig capacitance

Figure 4. Propagation Delay Test Circuit

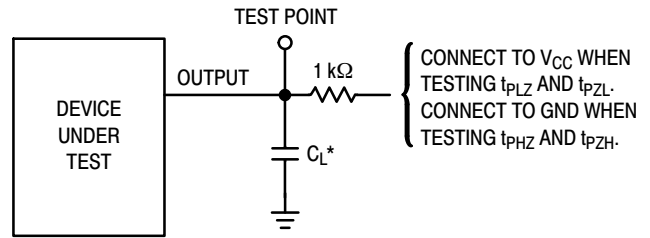

*Includes all probe and jig capacitance

Figure 5. Three-State Test Circuit

ORDERING INFORMATION

| Device | Package | Shipping† |
|-----------------|-----------------------|------------------|
| MC74LVX244DWR2G | SOIC-20 (Pb-Free) | 1000 Tape & Reel |
| MC74LVX244DTG | TSSOP-20 (Pb-Free) | 50 Units / Rail |
| MC74LVX244DTR2G | TSSOP-20 (Pb-Free) | 2500 Tape & Reel |

†For information on tape and reel specifications, including part orientation and tape sizes, please refer to our Tape and Reel Packaging Specifications Brochure, BRD8011/D.

MECHANICAL CASE OUTLINE PACKAGE DIMENSIONS

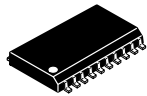

SCALE 1:1

SOIC-20 WB
CASE 751D-05
ISSUE H

DATE 22 APR 2015



NOTES:

1. DIMENSIONS ARE IN MILLIMETERS.
2. INTERPRET DIMENSIONS AND TOLERANCES PER ASME Y14.5M, 1994.
3. DIMENSIONS D AND E DO NOT INCLUDE MOLD PROTRUSION.
4. MAXIMUM MOLD PROTRUSION 0.15 PER SIDE.
5. DIMENSION B DOES NOT INCLUDE DAMBAR PROTRUSION. ALLOWABLE PROTRUSION SHALL BE 0.13 TOTAL IN EXCESS OF B DIMENSION AT MAXIMUM MATERIAL CONDITION.

| DIM | MILLIMETERS | |
|-----|-------------|-------|
| | MIN | MAX |
| A | 2.35 | 2.65 |
| A1 | 0.10 | 0.25 |
| b | 0.35 | 0.49 |
| c | 0.23 | 0.32 |
| D | 12.65 | 12.95 |
| E | 7.40 | 7.60 |
| e | 1.27 BSC | |
| H | 10.05 | 10.55 |
| h | 0.25 | 0.75 |
| L | 0.50 | 0.90 |
| θ | 0° | 7° |

RECOMMENDED
SOLDERING FOOTPRINT*



DIMENSIONS: MILLIMETERS

*For additional information on our Pb-Free strategy and soldering details, please download the ON Semiconductor Soldering and Mounting Techniques Reference Manual, SOLDERRM/D.

GENERIC
MARKING DIAGRAM*

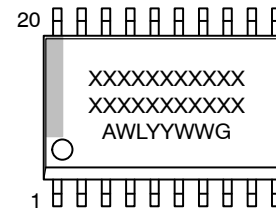

- XXXXXX = Specific Device Code
- A = Assembly Location
- WL = Wafer Lot
- YY = Year
- WW = Work Week
- G = Pb-Free Package

*This information is generic. Please refer to device data sheet for actual part marking. Pb-Free indicator, "G" or microdot "▪", may or may not be present. Some products may not follow the Generic Marking.

| | | |
|------------------|-------------|--|
| DOCUMENT NUMBER: | 98ASB42343B | Electronic versions are uncontrolled except when accessed directly from the Document Repository. Printed versions are uncontrolled except when stamped "CONTROLLED COPY" in red. |
| DESCRIPTION: | SOIC-20 WB | PAGE 1 OF 1 |

onsemi and ONsemi are trademarks of Semiconductor Components Industries, LLC dba onsemi or its subsidiaries in the United States and/or other countries. onsemi reserves the right to make changes without further notice to any products herein. onsemi makes no warranty, representation or guarantee regarding the suitability of its products for any particular purpose, nor does onsemi assume any liability arising out of the application or use of any product or circuit, and specifically disclaims any and all liability, including without limitation special, consequential or incidental damages. onsemi does not convey any license under its patent rights nor the rights of others.

MECHANICAL CASE OUTLINE

PACKAGE DIMENSIONS

ON Semiconductor®



TSSOP-20 WB
CASE 948E
ISSUE D

DATE 17 FEB 2016

SCALE 2:1

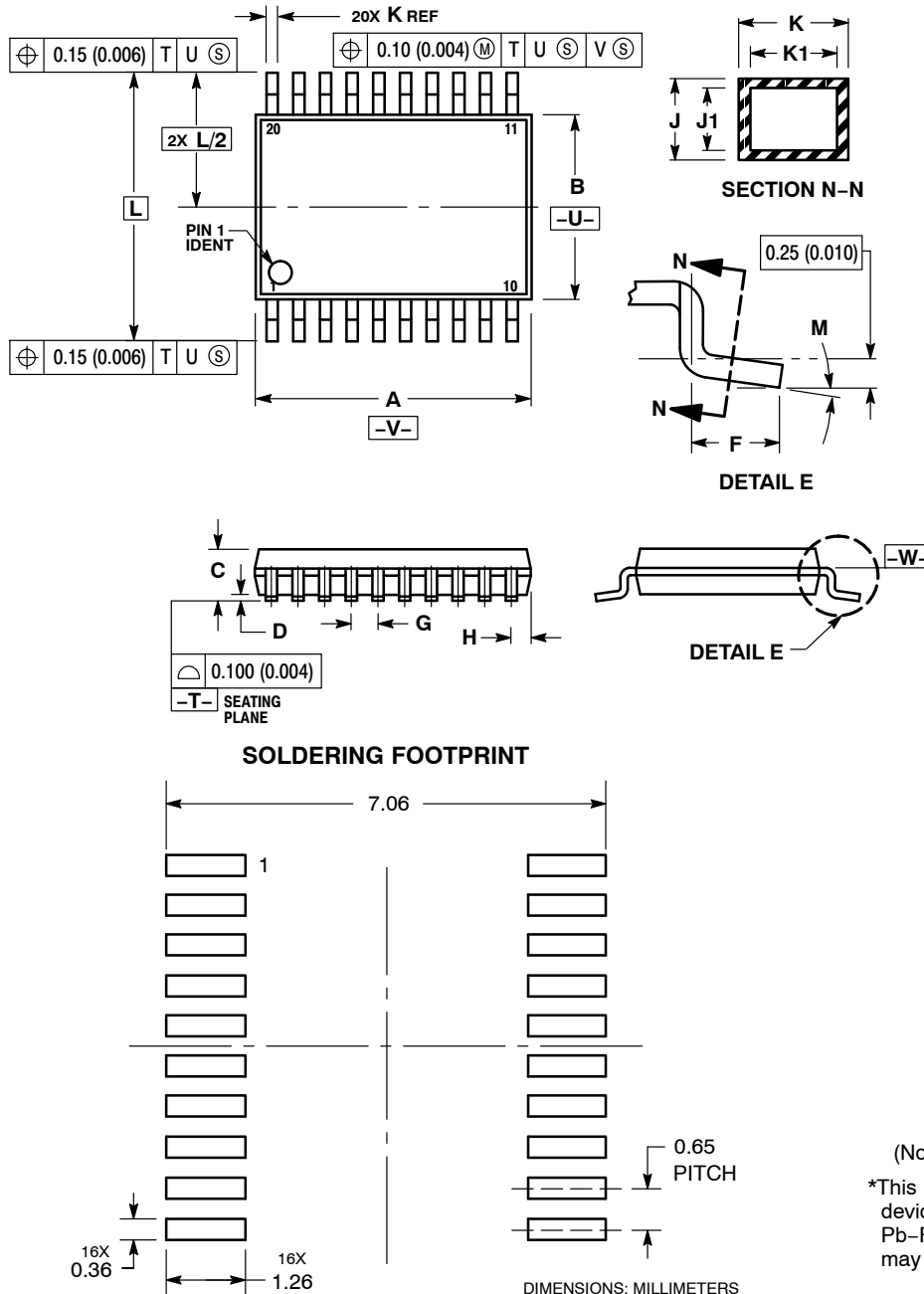

NOTES:

1. DIMENSIONING AND TOLERANCING PER ANSI Y14.5M, 1982.
2. CONTROLLING DIMENSION: MILLIMETER.
3. DIMENSION A DOES NOT INCLUDE MOLD FLASH, PROTRUSIONS OR GATE BURRS. MOLD FLASH OR GATE BURRS SHALL NOT EXCEED 0.15 (0.006) PER SIDE.
4. DIMENSION B DOES NOT INCLUDE INTERLEAD FLASH OR PROTRUSION. INTERLEAD FLASH OR PROTRUSION SHALL NOT EXCEED 0.25 (0.010) PER SIDE.
5. DIMENSION K DOES NOT INCLUDE DAMBAR PROTRUSION. ALLOWABLE DAMBAR PROTRUSION SHALL BE 0.08 (0.003) TOTAL IN EXCESS OF THE K DIMENSION AT MAXIMUM MATERIAL CONDITION.
6. TERMINAL NUMBERS ARE SHOWN FOR REFERENCE ONLY.
7. DIMENSION A AND B ARE TO BE DETERMINED AT DATUM PLANE -W-.

| DIM | MILLIMETERS | | INCHES | |
|-----|-------------|------|-----------|-------|
| | MIN | MAX | MIN | MAX |
| A | 6.40 | 6.60 | 0.252 | 0.260 |
| B | 4.30 | 4.50 | 0.169 | 0.177 |
| C | --- | 1.20 | --- | 0.047 |
| D | 0.05 | 0.15 | 0.002 | 0.006 |
| F | 0.50 | 0.75 | 0.020 | 0.030 |
| G | 0.65 BSC | | 0.026 BSC | |
| H | 0.27 | 0.37 | 0.011 | 0.015 |
| J | 0.09 | 0.20 | 0.004 | 0.008 |
| J1 | 0.09 | 0.16 | 0.004 | 0.006 |
| K | 0.19 | 0.30 | 0.007 | 0.012 |
| K1 | 0.19 | 0.25 | 0.007 | 0.010 |
| L | 6.40 BSC | | 0.252 BSC | |
| M | 0° | 8° | 0° | 8° |

GENERIC MARKING DIAGRAM*

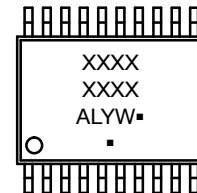

- A = Assembly Location
- L = Wafer Lot
- Y = Year
- W = Work Week
- = Pb-Free Package

(Note: Microdot may be in either location)

*This information is generic. Please refer to device data sheet for actual part marking. Pb-Free indicator, "G" or microdot "▪", may or may not be present.

| | | |
|-------------------------|--------------------|--|
| DOCUMENT NUMBER: | 98ASH70169A | Electronic versions are uncontrolled except when accessed directly from the Document Repository. Printed versions are uncontrolled except when stamped "CONTROLLED COPY" in red. |
| DESCRIPTION: | TSSOP-20 WB | PAGE 1 OF 1 |

ON Semiconductor and ON are trademarks of Semiconductor Components Industries, LLC dba ON Semiconductor or its subsidiaries in the United States and/or other countries. ON Semiconductor reserves the right to make changes without further notice to any products herein. ON Semiconductor makes no warranty, representation or guarantee regarding the suitability of its products for any particular purpose, nor does ON Semiconductor assume any liability arising out of the application or use of any product or circuit, and specifically disclaims any and all liability, including without limitation special, consequential or incidental damages. ON Semiconductor does not convey any license under its patent rights nor the rights of others.

onsemi, **Onsemi**, and other names, marks, and brands are registered and/or common law trademarks of Semiconductor Components Industries, LLC dba "**onsemi**" or its affiliates and/or subsidiaries in the United States and/or other countries. **onsemi** owns the rights to a number of patents, trademarks, copyrights, trade secrets, and other intellectual property. A listing of **onsemi**'s product/patent coverage may be accessed at www.onsemi.com/site/pdf/Patent-Marking.pdf. **onsemi** reserves the right to make changes at any time to any products or information herein, without notice. The information herein is provided "as-is" and **onsemi** makes no warranty, representation or guarantee regarding the accuracy of the information, product features, availability, functionality, or suitability of its products for any particular purpose, nor does **onsemi** assume any liability arising out of the application or use of any product or circuit, and specifically disclaims any and all liability, including without limitation special, consequential or incidental damages. Buyer is responsible for its products and applications using **onsemi** products, including compliance with all laws, regulations and safety requirements or standards, regardless of any support or applications information provided by **onsemi**. "Typical" parameters which may be provided in **onsemi** data sheets and/or specifications can and do vary in different applications and actual performance may vary over time. All operating parameters, including "Typicals" must be validated for each customer application by customer's technical experts. **onsemi** does not convey any license under any of its intellectual property rights nor the rights of others. **onsemi** products are not designed, intended, or authorized for use as a critical component in life support systems or any FDA Class 3 medical devices or medical devices with a same or similar classification in a foreign jurisdiction or any devices intended for implantation in the human body. Should Buyer purchase or use **onsemi** products for any such unintended or unauthorized application, Buyer shall indemnify and hold **onsemi** and its officers, employees, subsidiaries, affiliates, and distributors harmless against all claims, costs, damages, and expenses, and reasonable attorney fees arising out of, directly or indirectly, any claim of personal injury or death associated with such unintended or unauthorized use, even if such claim alleges that **onsemi** was negligent regarding the design or manufacture of the part. **onsemi** is an Equal Opportunity/Affirmative Action Employer. This literature is subject to all applicable copyright laws and is not for resale in any manner.

PUBLICATION ORDERING INFORMATION

LITERATURE FULFILLMENT:

Email Requests to: orderlit@onsemi.com

onsemi Website: www.onsemi.com

TECHNICAL SUPPORT

North American Technical Support:

Voice Mail: 1 800-282-9855 Toll Free USA/Canada

Phone: 011 421 33 790 2910

Europe, Middle East and Africa Technical Support:

Phone: 00421 33 790 2910

For additional information, please contact your local Sales Representative