

EQ50F100

1Gbps - 6.25 Gbps Backplane Equalizer

General Description

The EQ50F100 is an equalizer designed to compensate transmission medium losses and reduce the medium-induced deterministic jitter. It is optimized for operation from 1Gbps to 6.25Gbps, on printed circuit backplane for up to 30" of FR4 striplines with backplane connectors at both ends. It is code independent, and functioning equally well for short run length, balanced codes such as 8b/10b, commonly used in multiplexed 1.25 Gbps Ethernet Systems.

The equalizer uses differential CML inputs and outputs with feed-through pin-outs, mounted in a 3 mm x 3 mm 6-pin leadless LLP package. It is powered from single 1.8V supply and consumes 85 mW.

Features

- Recovers 6.25 Gbps signals after 30" of FR4
- Single 1.8V power supply
- Low power consumption: 85mW
- Equalize up to 20dB loss at 2.5 GHz
- 35 ps residual deterministic jitter at 5 Gbps
- On-chip CML terminations
- Small 3 mm x 3 mm 6-pin leadless LLP package

Simplified Function Diagram

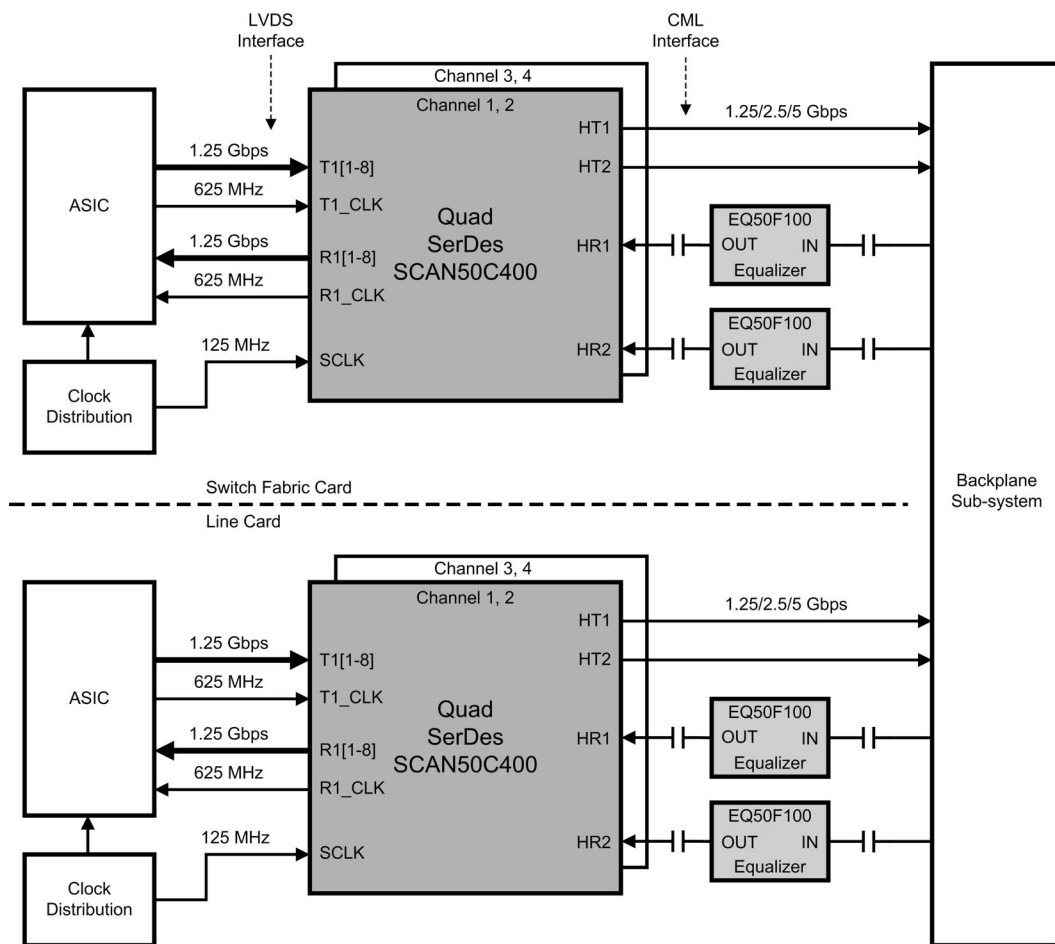

20096801

Note: Information contained in this datasheet is subject to change due to changes in design, specification and/or process, before EQ50F100 is production released.

Simplified Block Diagram

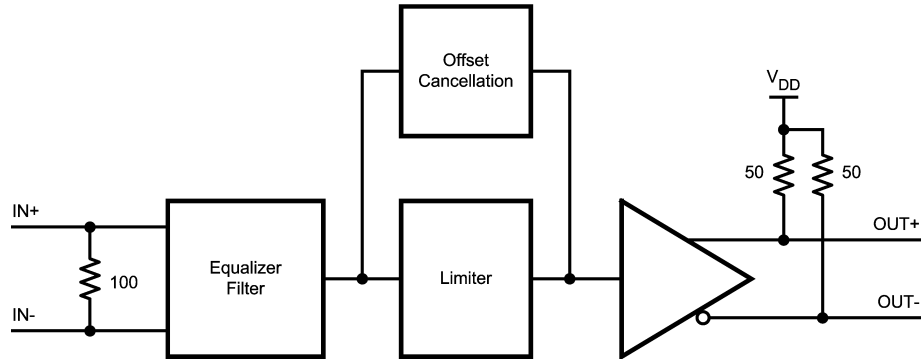

20096802

Pin Descriptions

Pin Name	Pin Number	I/O, Type	Description
HIGH SPEED DIFFERENTIAL I/O			
IN-	1	I, CML	Inverting and non-inverting CML differential inputs to the equalizer. An on-chip 100Ω terminating resistor is connected between IN+ and IN-.
IN+	6		
OUT-	3	O, CML	Inverting and non-inverting CML differential outputs from the equalizer. An on-chip 50Ω terminating resistor connects OUT+ to V _{DD} and OUT- to V _{DD} .
OUT+	4		
POWER			
V _{DD}	5	I, Power	V _{DD} = 1.8V ± 5%. V _{DD} pins should be tied to V _{DD} plane through low inductance path. A 0.01 μF bypass capacitor should be connected between the V _{DD} pin and the GND planes.
GND	2	I, Power	Ground reference. GND should be tied to a solid ground plane through a low impedance path.
Exposed Pad	PAD	I, Power	Connect to GND. The exposed pad at the center of the package should be connected to ground plane of the board to enhance thermal and electrical performance of the package.

Note: I = Input O = Output

Pin Diagram

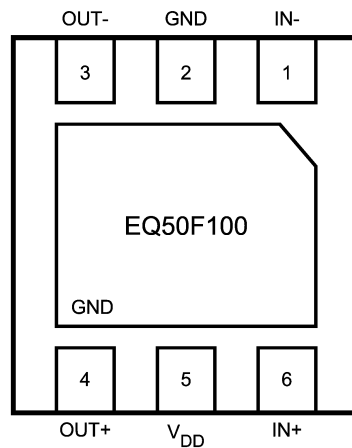

20096803

Top View Shown
3 mm x 3 mm 6-Pin LLP Package

Absolute Maximum Ratings (Note 1)

If Military/Aerospace specified devices are required, please contact the National Semiconductor Sales Office/Distributors for availability and specifications.

Supply Voltage (V_{DD})	-0.3V to +2.5V
CML Input/Output Voltage	-0.3V to ($V_{DD} + 0.3V$)
Junction Temperature	+150°C
Storage Temperature	-65°C to +150°C
Lead Temp. (Soldering, 5 sec.)	+260°C
ESD Rating	
HBM, 1.5 k Ω , 100 pF	>7 kV
EIAJ, 0 Ω , 200 pF	>200V

Thermal Resistance

 θ_{JA} , No Airflow

54°C/W

Recommended Operating Conditions

	Min	Typ	Max	Units
Supply Voltage (V_{DD} to GND)	1.71	1.8	1.89	V
Ambient Temperature	-40	25	85	°C

Electrical Characteristics

Over recommended operating supply and temperature ranges unless other specified.

Symbol	Parameter	Conditions	Min	Typ (Note 2)	Max	Units
POWER						
P	Power Supply Consumption			85	106	mW
N	Supply Noise Tolerance (Note 3)	10 Hz–100 Hz		100		mV _{P-P}
		100 Hz–10 MHz		50		mV _{P-P}
		10 MHz–2.5 GHz		10		mV _{P-P}
CML RECEIVER INPUTS (IN+, IN-)						
V_{IN}	Input Voltage Swing	Differential signal to equalizer, measured before test channel	400		1600	mV _{P-P}
R_{LI}	Differential Input Return Loss	100 MHz–2.5 GHz, with fixture's effect de-embedded		15		dB
R_{IN}	Input Resistance	Differential across IN+ and IN-	85	100	115	Ω
CML OUTPUTS (OUT+, OUT-)						
V_O	Output Voltage Swing	Measured differentially with OUT+ and OUT- terminated by 50 Ω to GND through DC block(Notes 9, 11)	450		800	mV _{P-P}
t_R, t_F	Transition Time	20% to 80% of differential output voltage, measured with 1" from output pins. (Notes 9, 11)	30	45	60	ps
R_O	Output Resistance	Single-ended to V_{DD}	42	50	58	Ω
R_{LO}	Differential Output Return Loss	100 MHz–2.5 GHz, with fixture's effect de-embedded. IN+ = static high.		14		dB
EQUALIZATION						
DJ1	Residual Deterministic Jitter at 6.25 Gb/s	Multiplexed K28.5 pattern, (Notes 4, 8), 30" Test channel, $V_{IN} = 1V_{P-P}$. (Note 11)		0.25	0.4	UI _{P-P}
DJ2	Residual Deterministic Jitter at 5 Gb/s	Multiplexed K28.5 pattern, (Notes 5, 8), 30" Test channel. $V_{IN} = 1V_{P-P}$. (Note 11)		0.13	0.35	UI _{P-P}
DJ3	Residual Deterministic Jitter at 2.5 Gb/s	Multiplexed K28.5 pattern, (Notes 6, 8), 30" Test channel, $V_{IN} = 1V_{P-P}$. (Note 11)		0.09	0.2	UI _{P-P}
DJ4	Residual Deterministic Jitter at 1.25 Gb/s	Multiplexed K28.5 pattern, (Notes 7, 8), 30" Test channel, $V_{IN} = 1V_{P-P}$. (Note 11)		0.04	0.15	UI _{P-P}
RJ	Random Jitter	(Notes 9, 10, 11)		0.75	1.0	psrms

Electrical Characteristics (Continued)

Over recommended operating supply and temperature ranges unless other specified.

Symbol	Parameter	Conditions	Min	Typ (Note 2)	Max	Units
LATENCY						
t_D	Latency	Measured from input to output, measured with multiplexed K28.5 pattern at 5Gb/s. (Notes 5, 11)	150	230	300	ps
BIT RATE						
BRMIN	Minimum Bit Rate			1		Gbps
BRMAX	Maximum Bit Rate			6.25		Gbps

Note 1: "Absolute Maximum Ratings" are the ratings beyond which the safety of the device cannot be guaranteed. They are not meant to imply that the device should be operated at these limits.

Note 2: Typical parameters are measured at $V_{DD} = 1.8V$, $T_A = 25^\circ C$. They are for reference purposes, and are not production-tested.

Note 3: Allowed supply noise (mV_{P-P} sine wave) during jitter tests.

Note 4: Test pattern at 6.25 Gbps is a combination of K28.5± characters running at full bit rate and at half bit rate. It is intended to simulate the multiplexing of two 3.125 Gb/s channels of a XAUI data stream.

Pattern in hex

0F FCCF 0033 (quarter rate of K28.5+, half rate of K28.5-)

3 EB05 (full rate K28.5±: 00 1111 1010 11 0000 0101)

Note 5: Test pattern at 5 Gbps is a combination of K28.5± characters running at full bit rate and at quarter bit rate. It is intended to simulate the multiplexing of four 1.25 Gb/s Ethernet data streams.

Pattern in hex

00 FFFF F0F0 FF 0000 0F0F (quarter rate of K28.5+, quarter rate of K28.5-)

3 EB05 (full rate K28.5±: 00 1111 1010 11 0000 0101)

Note 6: Test pattern at 2.5 Gbps is a combination of K28.5± characters running at full bit rate and at half bit rate. It is intended to simulate the multiplexing of two 1.25 Gb/s Ethernet data streams.

Pattern in hex

0F FCCF 0033 (half rate of K28.5+, half rate of K28.5-)

3 EB05 (full rate K28.5±: 00 1111 1010 11 0000 0101)

Note 7: Test pattern at 1.25 Gbps is K28.5± characters running at full bit rate

Pattern in hex

3 EB05 (full rate K28.5±: 00 1111 1010 11 0000 0101)

Note 8: Deterministic jitter is measured at the differential outputs, minus the deterministic jitter before the test channel. Random jitter is removed through the use of averaging or similar means.

Note 9: Test pattern is clock-like 11111 00000 pattern.

Note 10: Random jitter contributed by the equalizer is defined as $\text{sq rt}(J_{OUT}^2 - J_{IN}^2)$. J_{OUT} is the random jitter at equalizer outputs in ps-rms, J_{IN} is the random jitter at the input of the equalizer in ps-rms.

Note 11: V_O , t_R , t_F , t_D , DJ1, DJ2, DJ3, DJ4 and RJ specifications are Guaranteed by Design using statistical analysis.

Test Setup Diagram

TEST CHANNEL USED IN PRODUCTION TEST, TYPICAL EYE DIAGRAMS

The test channel used in production test and typical eye diagram is a FR4 stripline test channel that can be practically implemented in production load board environment, and yet with loss characteristics similar to a backplane that intended to test the device's equalization span.

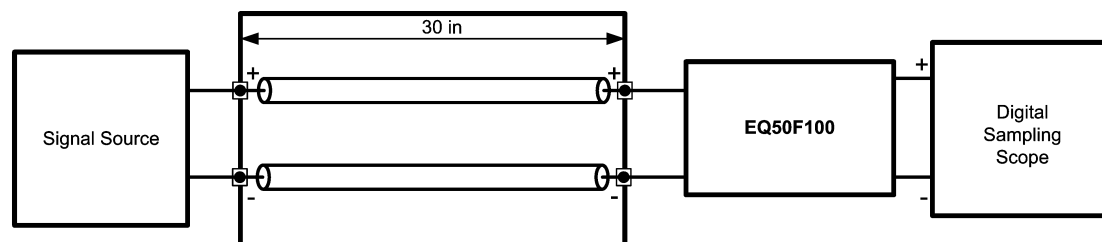

20096816

Functional Description

The EQ50F100 6.25Gbps Backplane Equalizer is a fixed, receive-end backplane equalizer. It enables serial transmission over FR-4 backplane with trace length of at least 30" at 6.25Gbps. It consists of an equalizer filter, limiting amplifier, offset driver, and offset cancellation circuit. The equalizer block compensates for the high frequency attenuation caused by the bandwidth-limited transmission channel found in backplane system. The limiting amplifier boost the signal at the output of the equalizer block. The offset cancellation circuit corrects for internal mis-match and offset from the previous stage to minimize duty-cycle distortion.

Input and Output

The input and output stage of the EQ50F100 is implemented using current mode logic (CML). The input stage has an equivalent DC differential input resistance of 100Ω . The positive and negative output channels are internally terminated with a 50Ω pull-up to VDD. AC coupling is recommended for both input and output.

Application Information

PCB LAYOUT AND POWER SYSTEM CONSIDERATIONS

Power system performance may be greatly improved by using thin dielectrics (2 to 4 mils) for power / ground sandwiches. This arrangement provides plane capacitance for the PCB power system with low-inductance parasitic. External bypass capacitors should include both RF ceramic and tantalum electrolytic types. RF capacitors may use values in the range of 0.1nF to 10nF. Tantalum capacitors may be in the 2.2uF to 10uF range. Voltage rating of the tantalum capacitors should be at least 5X the power supply voltage being used.

It is a recommended practice to use two vias at each power pin as well as at all RF bypass capacitor terminals. Dual vias reduce the interconnect inductance by up to half, thereby reducing interconnect inductance and extending the effective frequency range of the bypass components. Locate RF capacitors as close as possible to the supply pins, and use wide low impedance traces (not 50 Ohm traces). Surface mount capacitors are recommended due to their smaller parasitics. It is recommended to connect power and ground pins directly to the power and ground planes with bypass capacitors connected to the plane with via on both ends of the capacitor. Connecting power or ground pins to an external bypass capacitor will increase the inductance of the path.

A small body size X7R chip capacitor, such as 0603 or 0402, is recommended for external bypass. Its small body size reduces the parasitic inductance of the capacitor. The user must pay attention to the resonance frequency of these external bypass capacitors, usually in the range of 20-30 MHz range. To provide effective bypassing, multiple capacitors are often used to achieve low impedance between the supply rails over the frequency of interest. At high frequency, it is also a common practice to use two vias from power and ground pins to the planes, reducing the impedance at high frequency.

See AN-1187 for additional information on LLP package.

AC COUPLING

For multi-giga bit design, the smallest available package should be used for the AC coupling capacitor. This will help minimize degradation of signal quality due to package parasitics. The most common used capacitor value for the EQ50F100 interface is 0.1uF capacitor.

Typical Performance Characteristics

TYPICAL EYE DIAGRAM WITH 30" BACKPLANE CHARACTERISTICS

All typical eye diagrams are measured with a FR4 stripline test channel at $V_{DD} = 1.8V$, $T_A = 25^\circ C$ with PRBS-10 pattern at 1Vp-p at the source. They were acquired by an oscilloscope with 2k sampling hits, which includes approximately 10ps of system jitter. (Note 2)

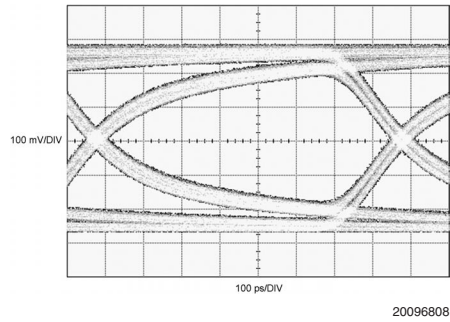

FIGURE 1. 1.25 Gb/s, PRBS-10 *Input* Signal to Equalizer after 30" of FR4

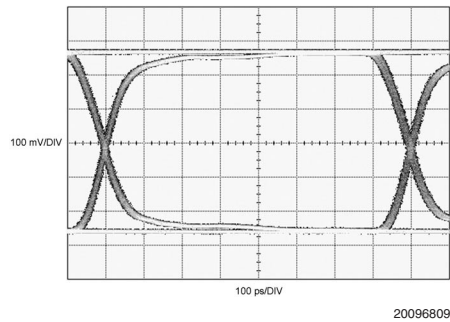

FIGURE 2. Typical 1.25 Gb/s Equalizer *Output* Signal, with Input as shown in *Figure 1*

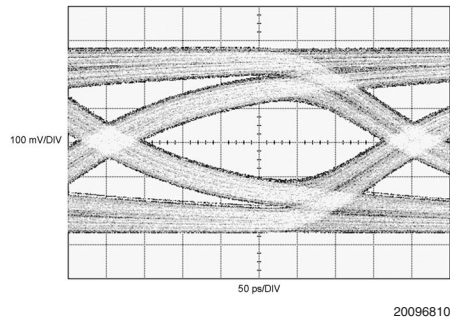

FIGURE 3. 2.5 Gb/s, PRBS-10 *Input* Signal to Equalizer after 30" of FR4

Typical Performance Characteristics (Continued)

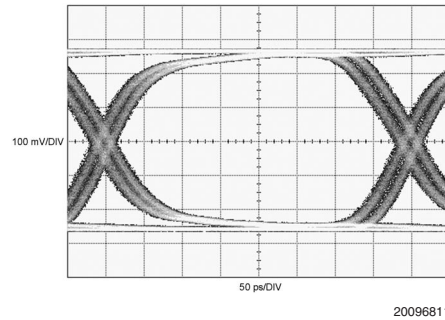

FIGURE 4. Typical 2.5Gb/s Equalizer *Output* Signal, with Input as shown in *Figure 3*

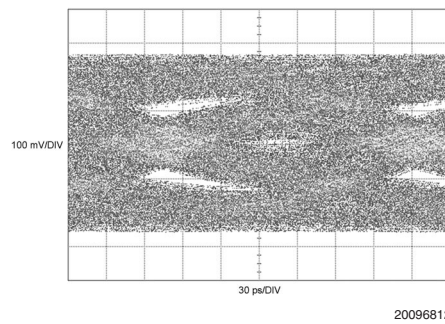

FIGURE 5. 5 Gb/s, PRBS-10 *Input* Signal to Equalizer after 30" of FR4

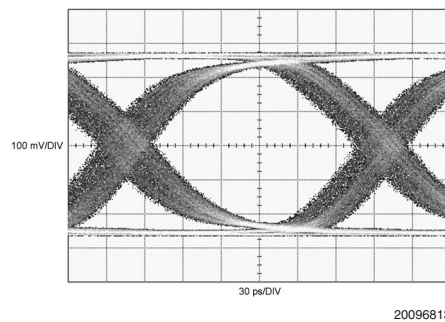

FIGURE 6. Typical 5Gb/s Equalizer *Output* Signal, with Input as shown in *Figure 5*

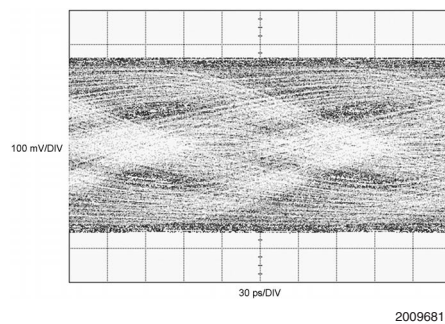

FIGURE 7. 6.25 Gb/s, PRBS-10 *Input* Signal to Equalizer after 30" of FR4

Typical Performance Characteristics (Continued)

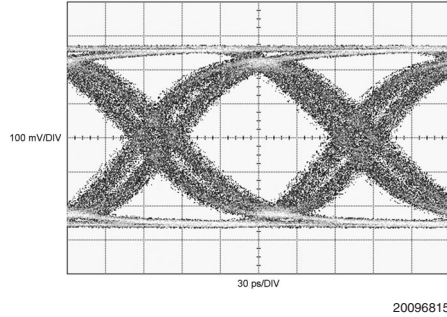
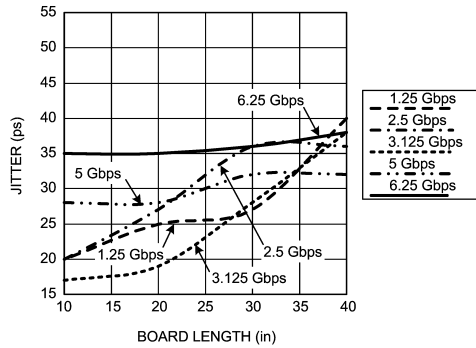

FIGURE 8. Typical 6.25Gb/s Equalizer *Output* Signal, with Input as shown in *Figure 7*

TYPICAL OPERATING CHARACTERISTICS

Typical performance are measured at $V_{DD} = 1.8V$, $T_A = 25^\circ C$, unless otherwise noted. They are measured with a FR4 stripline test channel and acquired by an oscilloscope with 2k sampling hits, which includes approximately 10ps of system jitter.



Total Jitter vs Board Length (FR4)
(Input Level = $1V_{P-P}$, K28.5 Pattern)

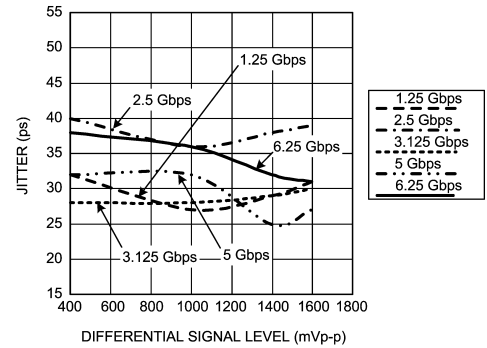

Total Jitter vs Signal Level
(K28.5 Pattern, 30in FR4 Board)

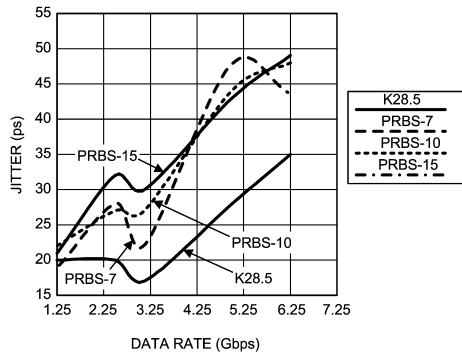

Total Jitter vs Data Rate
For 10in of FR4 Board
(Input Level = $1V_{P-P}$)

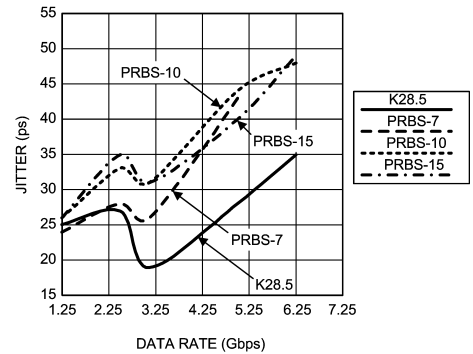

Total Jitter vs Data Rate
For 20in of FR4 Board
(Input Level = $1V_{P-P}$)

Typical Performance Characteristics (Continued)

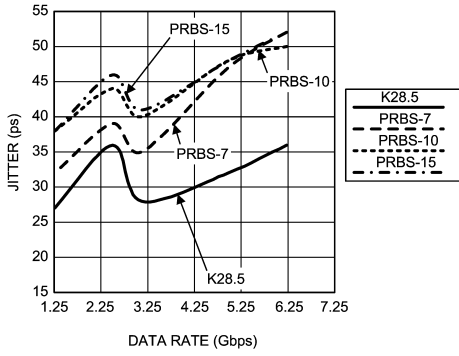

20096821

**Total Jitter vs Data Rate
For 30in of FR4 Board
(Input Level = 1V_{P-P})**

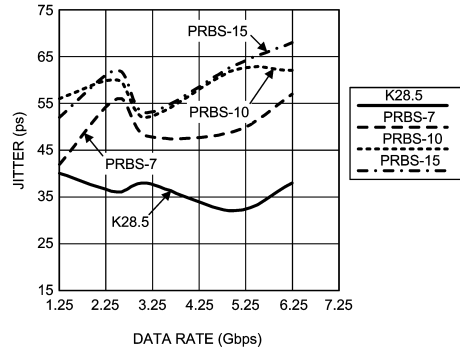

20096822

**Total Jitter vs Data Rate
For 40in of FR4 Board
(Input Level = 1V_{P-P})**

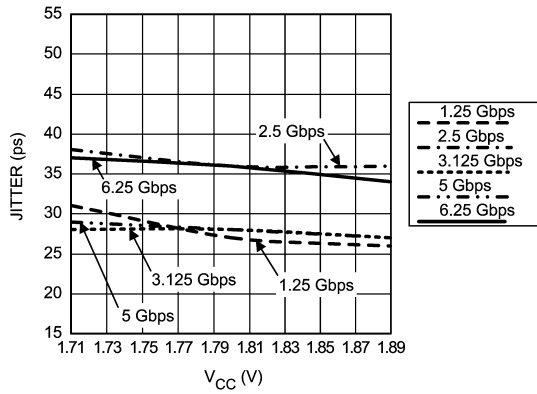

20096823

**Total Jitter vs Vcc
(Input Level = 1V_{P-P}, K28.5 Pattern)**

Physical Dimensions inches (millimeters) unless otherwise noted

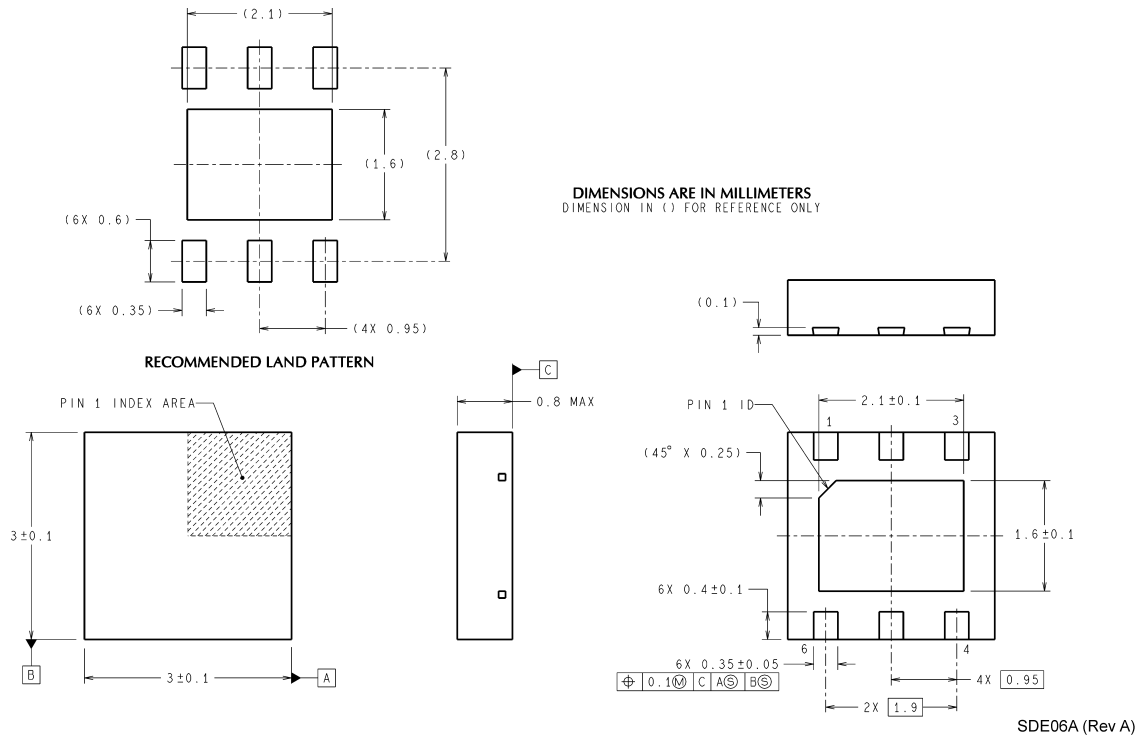

3mm x 3mm 6-pin leadless LLP package
Order Number EQ50F100LR
Package Number SDE06A

To order lead-free products, call your National Semiconductor distributors. They can order products for you with an "NOPB" specification. For more information on our Lead-free program, please check out our Lead-Free Status page.

National does not assume any responsibility for use of any circuitry described, no circuit patent licenses are implied and National reserves the right at any time without notice to change said circuitry and specifications.

For the most current product information visit us at www.national.com.

LIFE SUPPORT POLICY

NATIONAL'S PRODUCTS ARE NOT AUTHORIZED FOR USE AS CRITICAL COMPONENTS IN LIFE SUPPORT DEVICES OR SYSTEMS WITHOUT THE EXPRESS WRITTEN APPROVAL OF THE PRESIDENT AND GENERAL COUNSEL OF NATIONAL SEMICONDUCTOR CORPORATION. As used herein:

1. Life support devices or systems are devices or systems which, (a) are intended for surgical implant into the body, or (b) support or sustain life, and whose failure to perform when properly used in accordance with instructions for use provided in the labeling, can be reasonably expected to result in a significant injury to the user.
2. A critical component is any component of a life support device or system whose failure to perform can be reasonably expected to cause the failure of the life support device or system, or to affect its safety or effectiveness.

BANNED SUBSTANCE COMPLIANCE

National Semiconductor manufactures products and uses packing materials that meet the provisions of the Customer Products Stewardship Specification (CSP-9-111C2) and the Banned Substances and Materials of Interest Specification (CSP-9-111S2) and contain no "Banned Substances" as defined in CSP-9-111S2.

 **National Semiconductor**
Americas Customer Support Center
 Email: new.feedback@nsc.com
 Tel: 1-800-272-9959

National Semiconductor
Europe Customer Support Center
 Fax: +49 (0) 180-530 85 86
 Email: europe.support@nsc.com
 Deutsch Tel: +49 (0) 69 9508 6208
 English Tel: +44 (0) 870 24 0 2171
 Français Tel: +33 (0) 1 41 91 8790

National Semiconductor
Asia Pacific Customer Support Center
 Email: ap.support@nsc.com

National Semiconductor
Japan Customer Support Center
 Fax: 81-3-5639-7507
 Email: jpn.feedback@nsc.com
 Tel: 81-3-5639-7560