



# Improved Precision Micropower Shunt Voltage Reference with Multiple Reverse Breakdown Voltages

LM4040

## General Description

The LM4040 is a precision two-terminal shunt mode, bandgap voltage reference available in fixed reverse breakdown voltages of 2.048V, 2.500V, 3.000V, 4.096V, and 5.000V. Ideal for space-critical applications, the LM4040 is offered in the subminiature 3-pin SC70 surface-mount package (1.8mm × 1.8mm), 50% smaller than comparable devices in SOT23 surface-mount packages (SOT23 versions are also available).

Laser-trimmed resistors ensure precise initial accuracy. With a 100ppm/°C temperature coefficient, the device is offered in four grades of initial accuracy ranging from 0.1% to 1%. The LM4040 has a 60µA to 15mA shunt current capability with low dynamic impedance, ensuring stable reverse breakdown voltage accuracy over a wide range of operating temperatures and currents.

The LM4040 does not require an external stabilizing capacitor while ensuring stability with any capacitive load.

For a 1.225V output version, refer to the LM4041 data sheet.

## Features

- ◆ Ultra-Small 3-Pin SC70 Package
- ◆ 0.1% max Initial Accuracy
- ◆ 100ppm/°C max Temperature Coefficient  
Guaranteed over -40°C to +85°C Temperature Range
- ◆ Wide Operating Current Range: 60µA to 15mA
- ◆ Low 28µVRMS Output Noise (10Hz to 10kHz)
- ◆ 2.048V, 2.500V, 3.000V, 4.096V, and 5.000V Fixed Reverse Breakdown Voltage
- ◆ No Output Capacitors Required
- ◆ Tolerates Capacitive Loads

## Applications

Portable, Battery-Powered Equipment  
 Notebook Computers  
 Cell Phones  
 Industrial Process Controls

## Pin Configuration

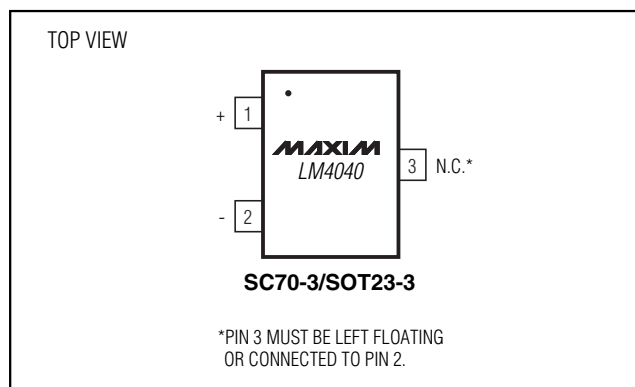

## Selector Guide

PART	TEMP. RANGE	PIN-PACKAGE	OUTPUT VOLTAGE (V)
LM4040_IX3-2.1	-40°C to +85°C	3 SOT23-3	2.048
LM4040_IX3-2.1	-40°C to +85°C	3 SC70-3	2.048
LM4040_IM3-2.5	-40°C to +85°C	3 SOT23-3	2.500
LM4040_IX3-2.5	-40°C to +85°C	3 SC70-3	2.500
LM4040_IM3-3.0	-40°C to +85°C	3 SOT23-3	3.000
LM4040_IX3-3.0	-40°C to +85°C	3 SC70-3	3.000
LM4040_IM3-4.1	-40°C to +85°C	3 SOT23-3	4.096
LM4040_IX3-4.1	-40°C to +85°C	3 SC70-3	4.096
LM4040_IM3-5.0	-40°C to +85°C	3 SOT23-3	5.000
LM4040_IX3-5.0	-40°C to +85°C	3 SC70-3	5.000

Ordering Information appears at end of data sheet.



# Improved Precision Micropower Shunt Voltage Reference with Multiple Reverse Breakdown Voltages

## ABSOLUTE MAXIMUM RATINGS

Reverse Current (cathode to anode) .....	20mA
Forward Current (anode to cathode) .....	10mA
ESD per Method 3015.7	
Human Body Model .....	2000V
Machine Model.....	200V
Continuous Power Dissipation ( $T_A = +70^\circ\text{C}$ )	
3-Pin SC70 (derate 2.17mW/ $^\circ\text{C}$ above $+70^\circ\text{C}$ ).....	174mW
3-Pin SOT23 (derate 4.01mW/ $^\circ\text{C}$ above $+70^\circ\text{C}$ ).....	320mW

Operating Temperature Range .....	$-40^\circ\text{C}$ to $+85^\circ\text{C}$
Storage Temperature Range .....	$-65^\circ\text{C}$ to $+150^\circ\text{C}$
Junction Temperature .....	$+150^\circ\text{C}$
Lead Temperature (soldering, 10s).....	$+300^\circ\text{C}$

Stresses beyond those listed under "Absolute Maximum Ratings" may cause permanent damage to the device. These are stress ratings only, and functional operation of the device at these or any other conditions beyond those indicated in the operational sections of the specifications is not implied. Exposure to absolute maximum rating conditions for extended periods may affect device reliability.

## ELECTRICAL CHARACTERISTICS—LM4040\_I\_3-2.1

( $I_R = 100\mu\text{A}$ ,  $T_A = T_{\text{MIN}}$  to  $T_{\text{MAX}}$ , unless otherwise noted. Typical values are at  $T_A = +25^\circ\text{C}$ .) (Note 1)

PARAMETER	SYMBOL	CONDITIONS		MIN	TYP	MAX	UNITS
Reverse Breakdown Voltage	$V_R$	$T_A = +25^\circ\text{C}$	LM4040A (0.1%)	2.046	2.048	2.050	V
			LM4040B (0.2%)	2.044	2.048	2.052	
			LM4040C (0.5%)	2.038	2.048	2.058	
			LM4040D (1.0%)	2.028	2.048	2.068	
Reverse Breakdown Voltage Tolerance (Note 2)	$V_R$		LM4040A		$\pm 2.0$	$\pm 15$	mV
			LM4040B		$\pm 4.0$	$\pm 17$	
			LM4040C		$\pm 10$	$\pm 23$	
			LM4040D		$\pm 20$	$\pm 41$	
Minimum Operating Current	$I_{\text{RMIN}}$		LM4040A/B/C		45	65	$\mu\text{A}$
			LM4040D		45	70	
Average Reverse Voltage Temperature Coefficient (Note 2)	$\Delta V_R/\Delta T$	$I_R = 10\text{mA}$			$\pm 20$		ppm/ $^\circ\text{C}$
		$I_R = 1\text{mA}$	LM4040A/B/C		$\pm 15$	$\pm 100$	
			LM4040D		$\pm 15$	$\pm 150$	
		$I_R = 100\mu\text{A}$			$\pm 15$		
Reverse Breakdown Voltage Change with Operating Current Change	$\Delta V_R/\Delta I_R$	$I_{\text{RMIN}} \leq I_R \leq 1\text{mA}$	LM4040A/B/C		0.3	1.0	mV
			LM4040D		0.3	1.2	
		$1\text{mA} \leq I_R \leq 15\text{mA}$	LM4040A/B/C		2.5	8.0	
			LM4040D		2.5	10.0	
Reverse Dynamic Impedance (Note 3)	$Z_R$	$I_R = 1\text{mA}$ , $f = 120\text{Hz}$ , $I_{\text{AC}} = 0.1I_R$	LM4040A/B		0.3	0.8	$\Omega$
			LM4040C		0.3	0.9	
			LM4040D		0.3	1.1	
Wideband Noise	$e_N$	$I_R = 100\mu\text{A}$ , $10\text{Hz} \leq f \leq 10\text{kHz}$			28		$\mu\text{VRMS}$
Reverse Breakdown Voltage Long-Term Stability	$\Delta V_R$	$T = 1000\text{h}$			120		ppm

# Improved Precision Micropower Shunt Voltage Reference with Multiple Reverse Breakdown Voltages

**LM4040**

## ELECTRICAL CHARACTERISTICS—LM4040\_I\_3-2.5

( $I_R = 100\mu\text{A}$ ,  $T_A = T_{\text{MIN}}$  to  $T_{\text{MAX}}$ , unless otherwise noted. Typical values are at  $T_A = +25^\circ\text{C}$ .) (Note 1)

PARAMETER	SYMBOL	CONDITIONS	MIN	TYP	MAX	UNITS	
Reverse Breakdown Voltage	$V_R$	$T_A = +25^\circ\text{C}$	LM4040A (0.1%)	2.4975	2.5000	2.5025	V
			LM4040B (0.2%)	2.4950	2.5000	2.5050	
			LM4040C (0.5%)	2.4875	2.5000	2.5125	
			LM4040D (1.0%)	2.2500	2.5000	2.7500	
Reverse Breakdown Voltage Tolerance (Note 2)	$V_R$		LM4040A	$\pm 2.0$	$\pm 19$	mV	
			LM4040B	$\pm 4.0$	$\pm 21$		
			LM4040C	$\pm 10$	$\pm 29$		
			LM4040D	$\pm 20$	$\pm 49$		
Minimum Operating Current	$I_{R\text{MIN}}$		LM4040A/B/C	45	65	$\mu\text{A}$	
			LM4040D	45	70		
Average Reverse Voltage Temperature Coefficient (Note 2)	$\Delta V_R/\Delta T$	$I_R = 10\text{mA}$		$\pm 20$		ppm/ $^\circ\text{C}$	
		$I_R = 1\text{mA}$	LM4040A/B/C	$\pm 15$	$\pm 100$		
			LM4040D	$\pm 15$	$\pm 150$		
		$I_R = 100\mu\text{A}$		$\pm 15$			
Reverse Breakdown Voltage Change with Operating Current Change	$\Delta V_R/\Delta I_R$	$I_{R\text{MIN}} \leq I_R \leq 1\text{mA}$	LM4040A/B/C	0.3	1.0	mV	
			LM4040D	0.4	1.2		
		$1\text{mA} \leq I_R \leq 15\text{mA}$	LM4040A/B/C	2.5	8.0		
			LM4040D	2.5	10.0		
Reverse Dynamic Impedance (Note 3)	$Z_R$	$I_R = 1\text{mA}$ , $f = 120\text{Hz}$ , $I_{AC} = 0.1I_R$	LM4040A/B	0.3	0.8	$\Omega$	
			LM4040C	0.3	0.9		
			LM4040D	0.3	1.1		
Wideband Noise	$e_N$	$I_R = 100\mu\text{A}$ , $10\text{Hz} \leq f \leq 10\text{kHz}$		35		$\mu\text{V}_{\text{RMS}}$	
Reverse Breakdown Voltage Long-Term Stability	$\Delta V_R$	$T = 1000\text{h}$		120		ppm	

# Improved Precision Micropower Shunt Voltage Reference with Multiple Reverse Breakdown Voltages

## ELECTRICAL CHARACTERISTICS—LM4040\_I\_3-3.0

( $I_R = 100\mu\text{A}$ ,  $T_A = T_{\text{MIN}}$  to  $T_{\text{MAX}}$ , unless otherwise noted. Typical values are at  $T_A = +25^\circ\text{C}$ .) (Note 1)

PARAMETER	SYMBOL	CONDITIONS	MIN	TYP	MAX	UNITS	
Reverse Breakdown Voltage	$V_R$	$T_A = +25^\circ\text{C}$	LM4040A (0.1%)	2.997	3.000	3.003	V
			LM4040B (0.2%)	2.994	3.000	3.006	
			LM4040C (0.5%)	2.985	3.000	3.015	
			LM4040D (1.0%)	2.970	3.000	3.030	
Reverse Breakdown Voltage Tolerance (Note 2)	$V_R$		LM4040A	$\pm 3.0$	$\pm 22$	mV	
			LM4040B	$\pm 6.0$	$\pm 26$		
			LM4040C	$\pm 15$	$\pm 34$		
			LM4040D	$\pm 30$	$\pm 59$		
Minimum Operating Current	$I_{R\text{MIN}}$		LM4040A/B/C	45	67	$\mu\text{A}$	
			LM4040D	45	70		
Average Reverse Voltage Temperature Coefficient (Note 2)	$\Delta V_R/\Delta T$	$I_R = 10\text{mA}$		$\pm 20$		ppm/ $^\circ\text{C}$	
		$I_R = 1\text{mA}$	LM4040A/B/C	$\pm 15$	$\pm 100$		
			LM4040D	$\pm 15$	$\pm 150$		
$I_R = 100\mu\text{A}$		$\pm 15$					
Reverse Breakdown Voltage Change with Operating Current Change	$\Delta V_R/\Delta I_R$	$I_{R\text{MIN}} \leq I_R \leq 1\text{mA}$	LM4040A/B/C	0.3	1.0	mV	
			LM4040D	0.3	1.2		
		$1\text{mA} \leq I_R \leq 15\text{mA}$	LM4040A/B/C	2.5	8.0		
			LM4040D	2.5	10.0		
Reverse Dynamic Impedance (Note 3)	$Z_R$	$I_R = 1\text{mA}$ , $f = 120\text{Hz}$ , $I_{AC} = 0.1I_R$	LM4040A/B	0.3	0.8	$\Omega$	
			LM4040C	0.3	0.9		
			LM4040D	0.3	1.1		
Wideband Noise	$e_N$	$I_R = 100\mu\text{A}$ , $10\text{Hz} \leq f \leq 10\text{kHz}$		45		$\mu\text{VRMS}$	
Reverse Breakdown Voltage Long-Term Stability	$\Delta V_R$	$T = 1000\text{h}$		120		ppm	

# Improved Precision Micropower Shunt Voltage Reference with Multiple Reverse Breakdown Voltages

**LM4040**

## ELECTRICAL CHARACTERISTICS—LM4040\_I\_3-4.1

( $I_R = 100\mu A$ ,  $T_A = T_{MIN}$  to  $T_{MAX}$ , unless otherwise noted. Typical values are at  $T_A = +25^\circ C$ .) (Note 1)

PARAMETER	SYMBOL	CONDITIONS		MIN	TYP	MAX	UNITS
Reverse Breakdown Voltage	$V_R$	$T_A = +25^\circ C$	LM4040A (0.1%)	4.092	4.096	4.100	V
			LM4040B (0.2%)	4.088	4.096	4.104	
			LM4040C (0.5%)	4.076	4.096	4.116	
			LM4040D (1.0%)	4.055	4.096	4.137	
Reverse Breakdown Voltage Tolerance (Note 2)	$V_R$		LM4040A		$\pm 4.1$	$\pm 31$	mV
			LM4040B		$\pm 8.2$	$\pm 35$	
			LM4040C		$\pm 20$	$\pm 47$	
			LM4040D		$\pm 41$	$\pm 81$	
Minimum Operating Current	$I_{RMIN}$		LM4040A/B/C		50	73	$\mu A$
			LM4040D		50	78	
Average Reverse Voltage Temperature Coefficient (Note 2)	$\Delta V_R/\Delta T$	$I_R = 10mA$			$\pm 30$		ppm/ $^\circ C$
		$I_R = 1mA$	LM4040A/B/C		$\pm 20$	$\pm 100$	
			LM4040D		$\pm 20$	$\pm 150$	
		$I_R = 100\mu A$			$\pm 15$		
Reverse Breakdown Voltage Change with Operating Current Change	$\Delta V_R/\Delta I_R$	$I_{RMIN} \leq I_R \leq 1mA$	LM4040A/B/C		0.5	1.2	mV
			LM4040D		0.5	1.5	
		$1mA \leq I_R \leq 15mA$	LM4040A/B/C		3.0	10.0	
			LM4040D		3.0	13.0	
Reverse Dynamic Impedance (Note 3)	$Z_R$	$I_R = 1mA$ , $f = 120Hz$ , $I_{AC} = 0.1I_R$	LM4040A/B/C		0.5	1.0	$\Omega$
			LM4040D		0.5	1.3	
Wideband Noise	$e_N$	$I_R = 100\mu A$ , $10Hz \leq f \leq 10kHz$			28		$\mu V_{RMS}$
Reverse Breakdown Voltage Long-Term Stability	$\Delta V_R$	$T = 1000h$			120		ppm

# Improved Precision Micropower Shunt Voltage Reference with Multiple Reverse Breakdown Voltages

## ELECTRICAL CHARACTERISTICS—LM4040\_I\_3-5.0

( $I_R = 100\mu\text{A}$ ,  $T_A = T_{\text{MIN}}$  to  $T_{\text{MAX}}$ , unless otherwise noted. Typical values are at  $T_A = +25^\circ\text{C}$ .) (Note 1)

PARAMETER	SYMBOL	CONDITIONS	MIN	TYP	MAX	UNITS	
Reverse Breakdown Voltage	$V_R$	$T_A = +25^\circ\text{C}$	LM4040A (0.1%)	4.995	5.000	5.005	V
			LM4040B (0.2%)	4.990	5.000	5.010	
			LM4040C (0.5%)	4.975	5.000	5.025	
			LM4040D (1.0%)	4.950	5.000	5.050	
Reverse Breakdown Voltage Tolerance (Note 2)	$V_R$		LM4040A	$\pm 5.0$	$\pm 38$	mV	
			LM4040B	$\pm 10$	$\pm 43$		
			LM4040C	$\pm 25$	$\pm 58$		
			LM4040D	$\pm 50$	$\pm 99$		
Minimum Operating Current	$I_{R\text{MIN}}$		LM4040A/B/C	54	80	$\mu\text{A}$	
			LM4040D	54	85		
Average Reverse Voltage Temperature Coefficient (Note 2)	$\Delta V_R / \Delta T$	$I_R = 10\text{mA}$		$\pm 30$		ppm/ $^\circ\text{C}$	
		$I_R = 1\text{mA}$	LM4040A/B/C	$\pm 20$	$\pm 100$		
			LM4040D	$\pm 20$	$\pm 150$		
Reverse Breakdown Voltage Change with Operating Current Change	$\Delta V_R / \Delta I_R$	$I_{R\text{MIN}} \leq I_R \leq 1\text{mA}$	LM4040A/B/C	0.5	1.4	mV	
			LM4040D	0.5	1.8		
		$1\text{mA} \leq I_R \leq 15\text{mA}$	LM4040A/B/C	3.5	12.0		
			LM4040D	3.5	15.0		
Reverse Dynamic Impedance (Note 3)	$Z_R$	$I_R = 1\text{mA}$ , $f = 120\text{Hz}$ , $I_{AC} = 0.1I_R$	LM4040A/B/C	0.5	1.1	$\Omega$	
			LM4040D	0.5	1.5		
Wideband Noise	$e_N$	$I_R = 100\mu\text{A}$ , $10\text{Hz} \leq f \leq 10\text{kHz}$		80		$\mu\text{V}_{\text{RMS}}$	
Reverse Breakdown Voltage Long-Term Stability	$\Delta V_R$	$T = 1000\text{h}$		120		ppm	

**Note 1:** All devices are 100% production tested at  $+25^\circ\text{C}$  and are guaranteed by design for  $T_A = T_{\text{MIN}}$  to  $T_{\text{MAX}}$ , as specified.

**Note 2:** The overtemperature limit for Reverse Breakdown Voltage Tolerance is defined as the room-temperature Reverse Breakdown Voltage Tolerance  $\pm[(\Delta V_R / \Delta T)(\text{max}\Delta T)(V_R)]$ , where  $\Delta V_R / \Delta T$  is the  $V_R$  temperature coefficient,  $\text{max}\Delta T$  is the maximum difference in temperature from the reference point of  $+25^\circ\text{C}$  to  $T_{\text{MIN}}$  or  $T_{\text{MAX}}$ , and  $V_R$  is the reverse breakdown voltage. The total overtemperature tolerance for the different grades in the temperature range where  $\text{max}\Delta T = +65^\circ\text{C}$  is shown below:

A grade:  $\pm 0.75\% = \pm 0.1\% \pm 100 \text{ ppm}/^\circ\text{C} \times 65^\circ\text{C}$

B grade:  $\pm 0.85\% = \pm 0.2\% \pm 100 \text{ ppm}/^\circ\text{C} \times 65^\circ\text{C}$

C grade:  $\pm 1.15\% = \pm 0.5\% \pm 100 \text{ ppm}/^\circ\text{C} \times 65^\circ\text{C}$

D grade:  $\pm 1.98\% = \pm 1.0\% \pm 150 \text{ ppm}/^\circ\text{C} \times 65^\circ\text{C}$

**Note 3:** Guaranteed by design.

# Improved Precision Micropower Shunt Voltage Reference with Multiple Reverse Breakdown Voltages

## Typical Operating Characteristics

( $I_R = 100\mu\text{A}$ , SC70-3 package,  $T_A = +25^\circ\text{C}$ , unless otherwise noted.)

**LM4040**

**REVERSE CHARACTERISTICS AND MINIMUM OPERATING CURRENT**

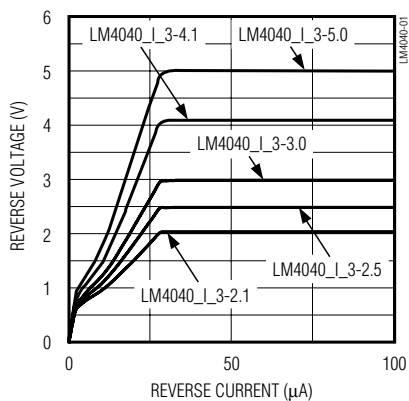

**LM4040-2.5V TEMPERATURE DRIFT**

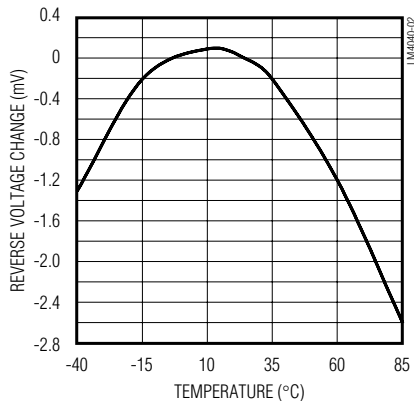

**LM4040-5.0V TEMPERATURE DRIFT**

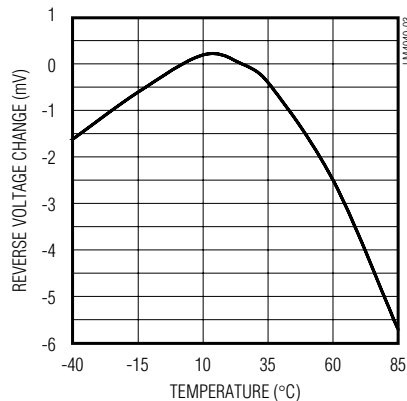

**LM4040-2.5V REVERSE VOLTAGE vs.  $I_{SHUNT}$**

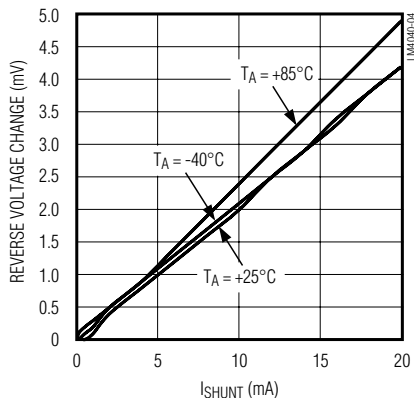

**LM4040-5.0V REVERSE VOLTAGE vs.  $I_{SHUNT}$**

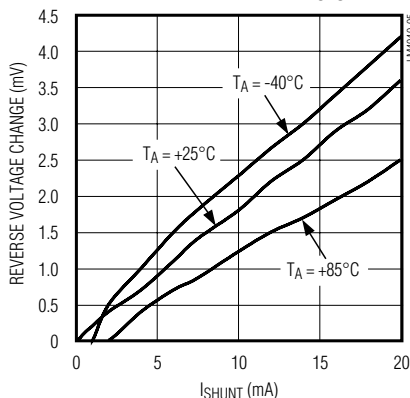

# Improved Precision Micropower Shunt Voltage Reference with Multiple Reverse Breakdown Voltages

## Typical Operating Characteristics (continued)

( $I_R = 100\mu\text{A}$ , SC70-3 package,  $T_A = +25^\circ\text{C}$ , unless otherwise noted.)

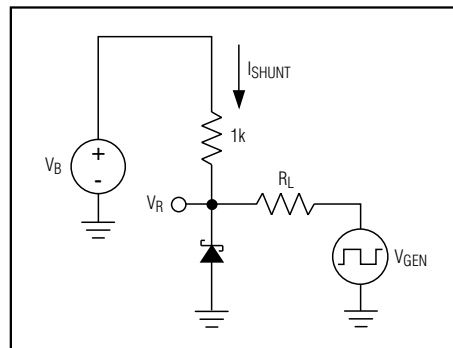
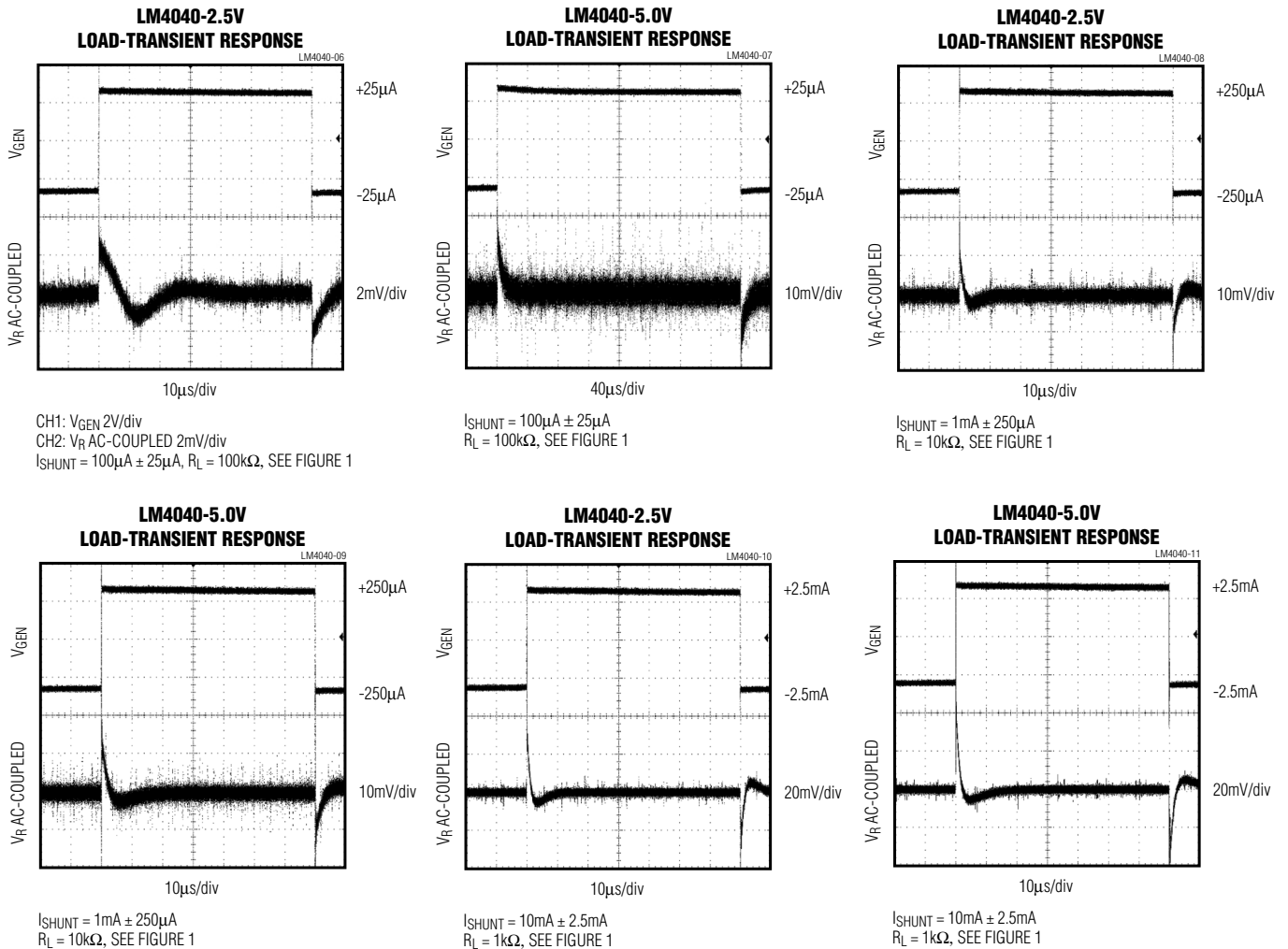

Figure 1. Load-Transient Test Circuit



# Improved Precision Micropower Shunt Voltage Reference with Multiple Reverse Breakdown Voltages

## Typical Operating Characteristics (continued)

( $I_R = 100\mu A$ , SC70-3 package,  $T_A = +25^\circ C$ , unless otherwise noted.)

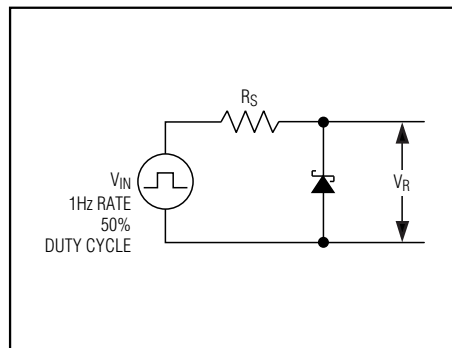
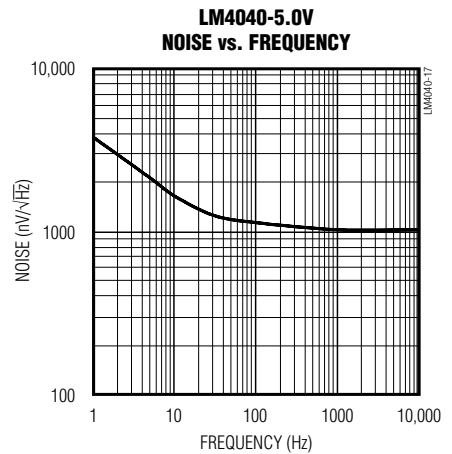
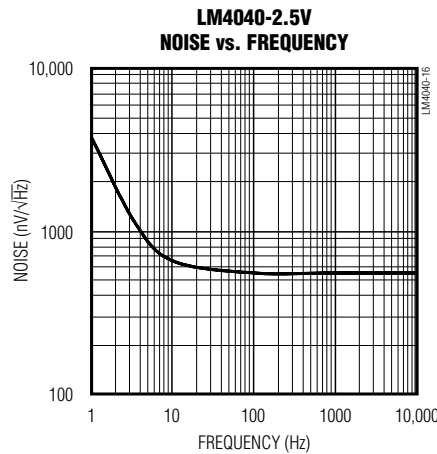
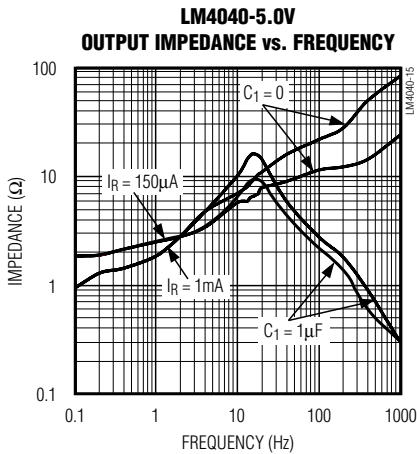
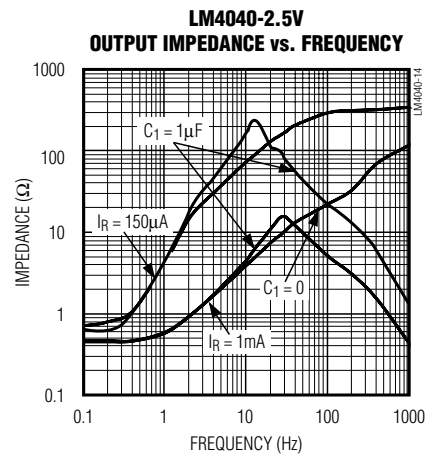
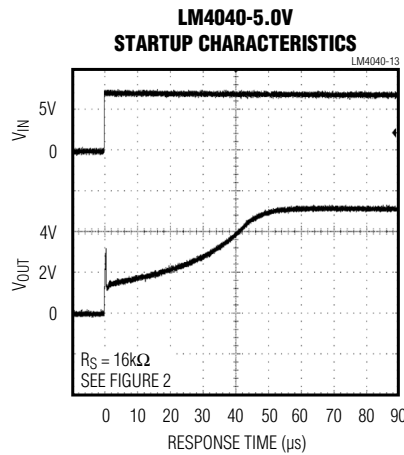
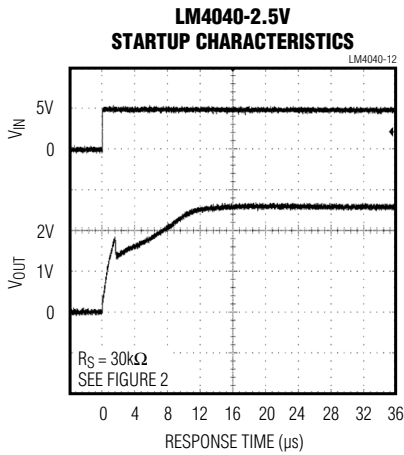

Figure 2. Startup Characteristics Test Circuit

# Improved Precision Micropower Shunt Voltage Reference with Multiple Reverse Breakdown Voltages

## Pin Description

PIN	NAME	FUNCTION
1	+	Positive Terminal of the Shunt Reference
2	-	Negative Terminal of the Shunt Reference
3	N.C.	No connection. Leave this pin unconnected or connected to Pin 2.

## Detailed Description

The LM4040 shunt references use the bandgap principle to produce a stable, accurate voltage. The device behaves similarly to an ideal zener diode; a fixed voltage is maintained across its output terminals when biased with 60µA to 15mA of reverse current. The LM4040 behaves similarly to a silicon diode when biased with forward currents up to 10mA.

Figure 3 shows a typical operating circuit. The LM4040 is ideal for providing a stable reference from a high-voltage power supply.

## Applications Information

The LM4040's internal pass transistor is used to maintain a constant output voltage ( $V_{SHUNT}$ ) by sinking the necessary amount of current across a source resistor. The source resistance ( $R_S$ ) is determined from the load current ( $I_{LOAD}$ ) range, supply voltage ( $V_S$ ) variations,  $V_{SHUNT}$ , and desired quiescent current.

Choose the value of  $R_S$  when  $V_S$  is at a minimum and  $I_{LOAD}$  is at a maximum. Maintain a minimum  $I_{SHUNT}$  of 60µA at all times. The  $R_S$  value should be large enough to keep  $I_{SHUNT}$  less than 15mA for proper regulation when  $V_S$  is maximum and  $I_{LOAD}$  is at a minimum. To prevent damage to the device,  $I_{SHUNT}$  should never exceed 20mA.

Therefore, the value of  $R_S$  is bounded by the following equation:

$$\frac{[V_S(\text{MIN}) - V_R]}{[60\mu\text{A} + I_{LOAD(\text{MAX})}]} > R_S > \frac{[V_S(\text{MAX}) - V_R]}{[20\text{mA} + I_{LOAD(\text{MIN})}]}$$

Choosing a larger resistance minimizes the total power dissipation in the circuit by reducing the shunt current ( $P_{D(\text{TOTAL})} = V_S \times I_{SHUNT}$ ). Provide a safety margin to incorporate the worst-case tolerance of the resistor used. Ensure that the resistor's power rating is adequate, using the following general power equation:

$$P_{DR} = I_{SHUNT} \times (V_S(\text{MAX}) - V_{SHUNT})$$

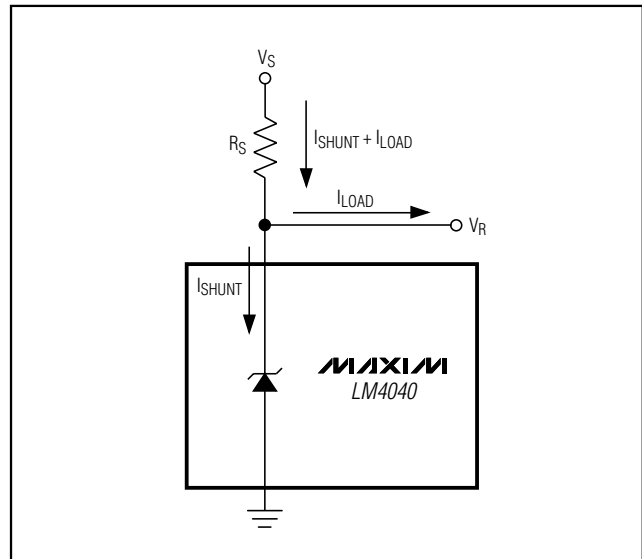

Figure 3. Typical Operating Circuit

## Output Capacitance

The LM4040 does not require an external capacitor for frequency stability and is stable for any output capacitance.

## Temperature Performance

The LM4040 typically exhibits an output voltage temperature coefficient within  $\pm 15\text{ppm}/^\circ\text{C}$ . The polarity of the temperature coefficient may be different from one device to another; some may have positive coefficients, and others may have negative coefficients.

## Chip Information

TRANSISTOR COUNT: 60

PROCESS: BiCMOS

# Improved Precision Micropower Shunt Voltage Reference with Multiple Reverse Breakdown Voltages

## Ordering Information

**LM4040**

PART	OUTPUT VOLTAGE (V)	INITIAL ACCURACY (%)	TEMPCO (ppm/°C)	TEMP. RANGE	PIN-PACKAGE	TOP MARK
LM4040AIM3-2.1	2.048	0.1	100	-40°C to +85°C	3 SOT23-3	FZEF
LM4040AIX3-2.1	2.048	0.1	100	-40°C to +85°C	3 SC70-3	ABJ
LM4040BIM3-2.1	2.048	0.2	100	-40°C to +85°C	3 SOT23-3	FZEG
LM4040BIX3-2.1	2.048	0.2	100	-40°C to +85°C	3 SC70-3	ABK
LM4040CIM3-2.1	2.048	0.5	100	-40°C to +85°C	3 SOT23-3	FZEH
LM4040CIX3-2.1	2.048	0.5	100	-40°C to +85°C	3 SC70-3	ABL
LM4040DIM3-2.1	2.048	1.0	150	-40°C to +85°C	3 SOT23-3	FZEI
LM4040DIX3-2.1	2.048	1.0	150	-40°C to +85°C	3-SC70-3	ABM
LM4040AIM3-2.5	2.500	0.1	100	-40°C to +85°C	3 SOT23-3	FZEJ
LM4040AIX3-2.5	2.500	0.1	100	-40°C to +85°C	3 SC70-3	ABN
LM4040BIM3-2.5	2.500	0.2	100	-40°C to +85°C	3 SOT23-3	FZEK
LM4040BIX3-2.5	2.500	0.2	100	-40°C to +85°C	3 SC70-3	ABO
LM4040CIM3-2.5	2.500	0.5	100	-40°C to +85°C	3 SOT23-3	FZEL
LM4040CIX3-2.5	2.500	0.5	100	-40°C to +85°C	3 SC70-3	ABP
LM4040DIM3-2.5	2.500	1.0	150	-40°C to +85°C	3 SOT23-3	FZEM
LM4040DIX3-2.5	2.500	1.0	150	-40°C to +85°C	3 SC70-3	ABQ
LM4040AIM3-3.0	3.000	0.1	100	-40°C to +85°C	3 SOT23-3	FZEN
LM4040AIX3-3.0	3.000	0.1	100	-40°C to +85°C	3 SC70-3	ABR
LM4040BIM3-3.0	3.000	0.2	100	-40°C to +85°C	3 SOT23-3	FZEO
LM4040BIX3-3.0	3.000	0.2	100	-40°C to +85°C	3 SC70-3	ABS
LM4040CIM3-3.0	3.000	0.5	100	-40°C to +85°C	3 SOT23-3	FZEP
LM4040CIX3-3.0	3.000	0.5	100	-40°C to +85°C	3 SC70-3	ABT
LM4040DIM3-3.0	3.000	1.0	150	-40°C to +85°C	3 SOT23-3	FZEQ
LM4040DIX3-3.0	3.000	1.0	150	-40°C to +85°C	3 SC70-3	ABU
LM4040AIM3-4.1	4.096	0.1	100	-40°C to +85°C	3 SOT23-3	FZER
LM4040AIX3-4.1	4.096	0.1	100	-40°C to +85°C	3 SC70-3	ABV
LM4040BIM3-4.1	4.096	0.2	100	-40°C to +85°C	3 SOT23-3	FZES
LM4040BIX3-4.1	4.096	0.2	100	-40°C to +85°C	3 SC70-3	ABW
LM4040CIM3-4.1	4.096	0.5	100	-40°C to +85°C	3 SOT23-3	FZET
LM4040CIX3-4.1	4.096	0.5	100	-40°C to +85°C	3 SC70-3	ABX
LM4040DIM3-4.1	4.096	1.0	150	-40°C to +85°C	3 SOT23-3	FZEU
LM4040DIX3-4.1	4.096	1.0	150	-40°C to +85°C	3 SC70-3	ABY
LM4040AIM3-5.0	5.000	0.1	100	-40°C to +85°C	3 SOT23-3	FZEV
LM4040AIX3-5.0	5.000	0.1	100	-40°C to +85°C	3 SC70-3	ABZ
LM4040BIM3-5.0	5.000	0.2	100	-40°C to +85°C	3 SOT23-3	FZEW
LM4040BIX3-5.0	5.000	0.2	100	-40°C to +85°C	3 SC70-3	ACA
LM4040CIM3-5.0	5.000	0.5	100	-40°C to +85°C	3 SOT23-3	FZEX
LM4040CIX3-5.0	5.000	0.5	100	-40°C to +85°C	3 SC70-3	ACB
LM4040DIM3-5.0	5.000	1.0	150	-40°C to +85°C	3 SOT23-3	FZEY
LM4040DIX3-5.0	5.000	1.0	150	-40°C to +85°C	3 SC70-3	ACC

# Improved Precision Micropower Shunt Voltage Reference with Multiple Reverse Breakdown Voltages

## Package Information

NOTES:

1. D&E DO NOT INCLUDE MOLD FLASH.
2. MOLD FLASH OR PROTRUSIONS NOT TO EXCEED .15mm (.006")
3. CONTROLLING DIMENSION: MILLIMETER

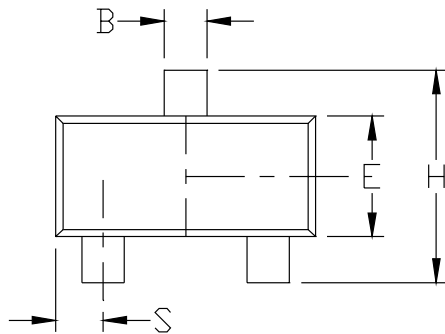

DIM	INCHES		MILLIMETERS	
	MIN	MAX	MIN	MAX
A	0.031	0.047	0.787	1.194
A1	0.001	0.005	0.025	0.127
B	0.014	0.022	0.356	0.559
C	0.0034	0.006	0.086	0.152
D	0.105	0.120	2.667	3.048
E	0.047	0.055	1.194	1.397
e	0.070	0.080	1.778	2.032
H	0.082	0.098	2.083	2.489
L	0.004	0.012	0.102	0.305
S	0.017	0.022	0.432	0.559
$\alpha$	0°	8°	0°	8°

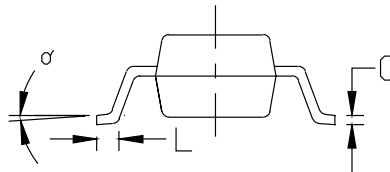
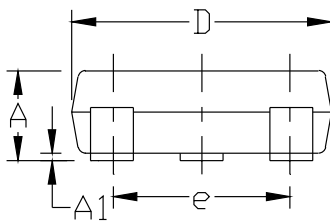

<b>MAXIM</b>			
<small>PROPRIETARY INFORMATION</small>			
<small>TITLE:</small>			
PACKAGE OUTLINE, SOT-23, 3L			
<small>APPROVAL</small>	<small>DOCUMENT CONTROL NO.</small>	<small>REV</small>	<small>1/1</small>
	21-0051	C	

SOT23-3L

# Improved Precision Micropower Shunt Voltage Reference with Multiple Reverse Breakdown Voltages

## Package Information (continued)

**LM4040**

SC70, 3LEPS

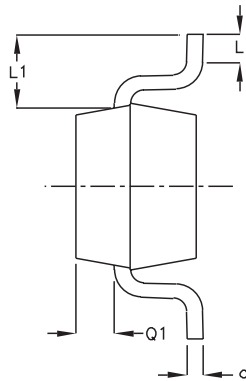
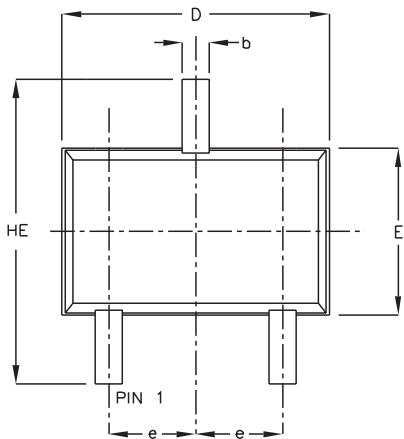

SYMBOL	MIN	MAX
e	0.65	BSC
D	1.80	2.20
b	0.25	0.40
E	1.15	1.35
HE	1.80	2.40
Q1	0.10	0.40
A2	0.80	1.00
A1	0.00	0.10
A	0.80	1.10
c	0.10	0.18
L	0.10	0.30
L1	0.425	TYP.

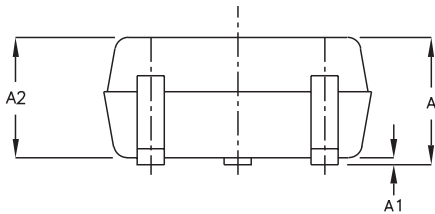

- NOTE:
1. ALL DIMENSIONS ARE IN MILLIMETERS
  2. DIMENSIONS ARE INCLUSIVE OF PLATING
  3. DIMENSIONS ARE EXCLUSIVE OF MOLD FLASH & METAL BURR
  4. ALL SPECIFICATIONS COMPLY TO EIAJ SC70
  5. COPLANARITY 4 MILS. MAX.

<b>MAXIM</b>			
PROPRIETARY INFORMATION			
TITLE:			
PACKAGE OUTLINE, SC70, 3L			
APPROVAL	DOCUMENT CONTROL NO.	REV	1/1
	21-0075	B	

Maxim cannot assume responsibility for use of any circuitry other than circuitry entirely embodied in a Maxim product. No circuit patent licenses are implied. Maxim reserves the right to change the circuitry and specifications without notice at any time.

13 \_\_\_\_\_ **Maxim Integrated Products, 120 San Gabriel Drive, Sunnyvale, CA 94086 408-737-7600**