

SN65ALS172A, SN75ALS172A QUADRUPLE DIFFERENTIAL LINE DRIVERS

SLLS121C – AUGUST 1990 – REVISED MAY 1995

- Meets or Exceeds ANSI Standards EIA/TIA-422-B and RS-485 and ITU Recommendation V.11
- High-Speed Advanced Low-Power Schottky Circuitry
- Designed for 20-MBaud Operation In Both Serial and Parallel Applications
- Designed for Multipoint Transmission on Long Bus Lines in Noisy Environments
- Low Supply Current Requirements
55 mA Max
- Wide Positive and Negative Input/Output Bus Voltages Ranges
- Driver Output Capacity . . . ± 60 mA
- Thermal Shutdown Protection
- Driver Positive and Negative Current Limiting
- Logically Interchangeable With SN75172

description

The SN65ALS172A and SN75ALS172A are comprised of four line drivers with 3-state differential outputs. They are designed to meet the requirements of ANSI Standards EIA/TIA-422-B and RS-485 and ITU Recommendation V.11. These devices are optimized for balanced multipoint bus transmission at rates of up to 20 Mbaud. Each driver features wide positive and negative common-mode output voltage ranges making them suitable for party-line applications in noisy environments.

The SN65ALS172A and SN75ALS172A provide positive- and negative-current limiting and thermal shutdown for protection from line fault conditions on the transmission bus line. Shutdown occurs at a junction temperature of approximately 150°C.

The SN65ALS172A is characterized for operation from -40°C to 85°C and the SN75ALS172A is characterized for operation from 0°C to 70°C.

SN75ALS172A . . . N PACKAGE
(TOP VIEW)

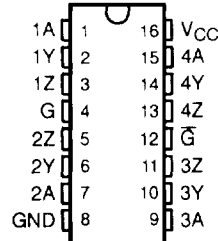

DW PACKAGE
(TOP VIEW)

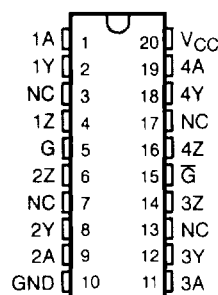

NC--No internal connection

FUNCTION TABLE
(each driver)

INPUT A	ENABLES		OUTPUTS	
	G	\bar{G}	Y	Z
H	H	X	H	L
L	H	X	L	H
H	X	L	H	L
L	X	L	L	H
X	L	H	Z	Z

H = high level, L = low level, X = irrelevant, Z = high impedance (off)

PRODUCTION DATA information is current as of publication date. Products conform to specifications per the terms of Texas Instruments standard warranty. Production processing does not necessarily include testing of all parameters.

TEXAS
INSTRUMENTS

POST OFFICE BOX 655303 • DALLAS, TEXAS 75265

Copyright © 1995, Texas Instruments Incorporated

2-443

SN65ALS172A, SN75ALS172A QUADRUPLE DIFFERENTIAL LINE DRIVERS

SLLS121C – AUGUST 1990 – REVISED MAY 1995

logic symbol†

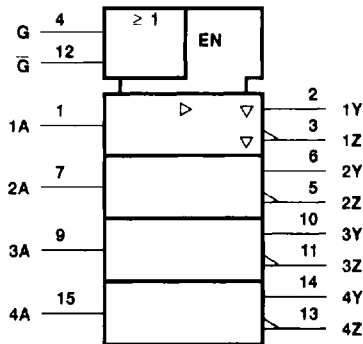

logic diagram (positive logic)

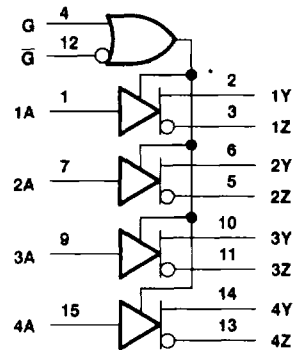

† This symbol is in accordance with ANSI/IEEE Std 91-1984 and IEC Publication 617-12.

Terminal numbers shown are for the N package.

schematics of inputs and outputs

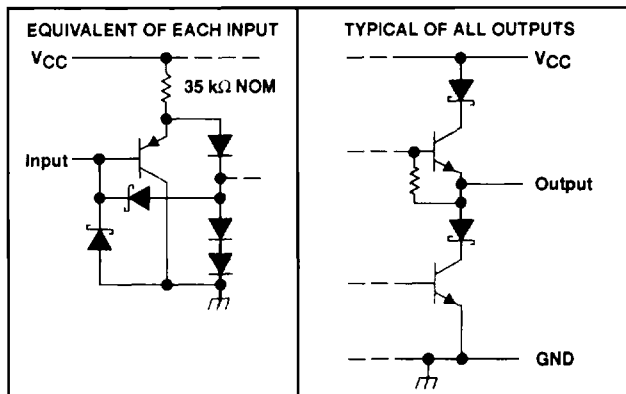

SN65ALS172A, SN75ALS172A QUADRUPLE DIFFERENTIAL LINE DRIVERS

SLLS121C – AUGUST 1990 – REVISED MAY 1995

absolute maximum ratings over operating free-air temperature range (unless otherwise noted)†

Supply voltage, V_{CC} (see Note 1)	7 V
Input voltage, V_I	7 V
Output voltage range, V_O	–9 V to 14 V
Continuous total dissipation	See Dissipation Rating Table
Operating free-air temperature range, T_A : SN65ALS172A	–40°C to 85°C
SN75ALS172A	0°C to 70°C
Storage temperature range, T_{stg}	–65°C to 150°C
Lead temperature 1,6 mm (1/16 inch) from case for 10 seconds	260°C

† Stresses beyond those listed under “absolute maximum ratings” may cause permanent damage to the device. These are stress ratings only, and functional operation of the device at these or any other conditions beyond those indicated under “recommended operating conditions” is not implied. Exposure to absolute-maximum-rated conditions for extended periods may affect device reliability.

NOTE 1: All voltage values are with respect to network ground terminal.

DISSIPATION RATING TABLE

PACKAGE	$T_A \leq 25^\circ\text{C}$ POWER RATING	DERATING FACTOR	$T_A = 70^\circ\text{C}$ POWER RATING	$T_A = 85^\circ\text{C}$ POWER RATING
DW	1125 mW	9 mW/°C	720 mW	585 mW
N	1150 mW	9.2 mW/°C	736 mW	598 mW

recommended operating conditions

	MIN	NOM	MAX	UNIT
Supply voltage, V_{CC}	4.75	5	5.25	V
High-level input voltage, V_{IH}	2			V
Low-level input voltage, V_{IL}	0.8			V
Common-mode output voltage, V_{OC}	+12 –7			V
High-level output current, I_{OH}	–60			mA
Low-level output current, I_{OL}	60			mA
Operating free-air temperature, T_A	SN65ALS172A		–40	85
	SN75ALS172A		0	70
				°C



SN65ALS172A, SN75ALS172A QUADRUPLE DIFFERENTIAL LINE DRIVERS

SLLS121C – AUGUST 1990 – REVISED MAY 1995

electrical characteristics over recommended ranges of supply voltage and operating free-air temperature (unless otherwise noted)

PARAMETER		TEST CONDITIONS		MIN	TYP†	MAX	UNIT
V_{IK}	Input clamp voltage	$I_I = -18 \text{ mA}$				-1.5	V
V_O	Output voltage	$I_O = 0$		0		6	V
$ V_{OD1} $	Differential output voltage	$I_O = 0$		1.5		6	V
$ V_{OD2} $	Differential output voltage	$V_{CC} = 5 \text{ V},$ $R_L = 100 \Omega$	See Figure 1	$1/2 V_{OD1}$ or 2^\ddagger			V
		$R_L = 54 \Omega$		1.5	2.5	5	
$ V_{OD3} $	Differential output voltage	See Note 2		1.5		5	V
$\Delta V_{OD} $	Change in magnitude of differential output voltage §	$R_L = 54 \Omega$ or 100Ω , See Figure 1				± 0.2	V
V_{OC}	Common-mode output voltage $^{\parallel}$					+3 -1	V
$\Delta V_{OC} $	Change in magnitude of common-mode output voltage §					± 0.2	V
I_O	Output current with power off	$V_{CC} = 0,$	$V_O = -7 \text{ V to } 12 \text{ V}$			± 100	μA
I_{OZ}	High-impedance-state output current	$V_O = -7 \text{ V to } 12 \text{ V}$				± 100	μA
I_{IH}	High-level input current	$V_I = 2.7 \text{ V}$				20	μA
I_{IL}	Low-level input current	$V_I = 0.4 \text{ V}$				-100	μA
I_{OS}	Short-circuit output current	$V_O = -7 \text{ V to } 12 \text{ V}$				± 250	mA
I_{CC}	Supply current (all drivers)	No load	Outputs enabled		36	55	mA
			Outputs disabled		15	30	

† All typical values are at $V_{CC} = 5 \text{ V}$ and $T_A = 25^\circ\text{C}$.

‡ The minimum V_{OD2} with a $100\text{-}\Omega$ load is either $1/2 V_{OD1}$ or 2 V , whichever is greater.

$\S \Delta|V_{OD}|$ and $\Delta|V_{OC}|$ are the changes in magnitude of V_{OD} and V_{OC} , respectively, that occur when the input is changed from a high level to a low level.

$^{\parallel}$ In ANSI Standard EIA/TIA-422-B, V_{OC} , which is the average of the two output voltages with respect to ground, is called output offset voltage, V_{OS} .

NOTE 2: See EIA Standard RS-485, Figure 3-5, Test Termination Measurement 2.

switching characteristics over recommended ranges of supply voltage and operating free-air temperature, $C_L = 50 \text{ pF}$

PARAMETER		TEST CONDITIONS		MIN	TYP†	MAX	UNIT
$t_{d(OD)}$	Differential-output delay time	$R_L = 54 \Omega,$	See Figure 2	9	15	22	ns
t_{pZH}	Output enable time to high level	$R_L = 110 \Omega,$	See Figure 3	30	45	70	ns
t_{pZL}	Output enable time to low level	$R_L = 110 \Omega,$	See Figure 4	25	40	65	ns
t_{pHZ}	Output disable time from high level	$R_L = 110 \Omega,$	See Figure 3	10	20	35	ns
t_{pLZ}	Output disable time from low level	$R_L = 110 \Omega,$	See Figure 4	10	30	45	ns

† All typical values are at $V_{CC} = 5 \text{ V}$ and $T_A = 25^\circ\text{C}$.



POST OFFICE BOX 655303 • DALLAS, TEXAS 75265

PARAMETER MEASUREMENT INFORMATION

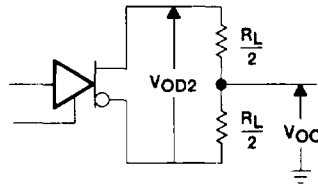
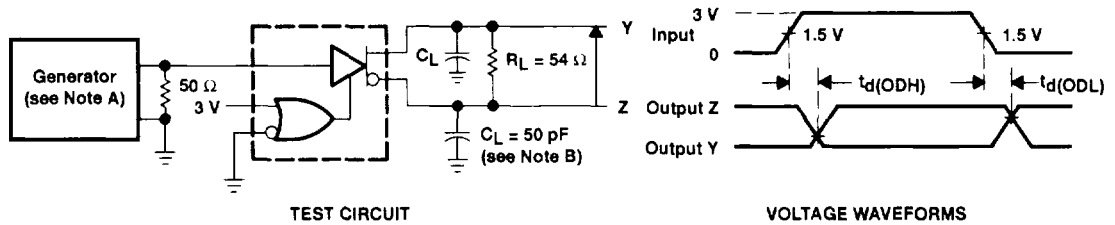

Figure 1. Differential and Common-Mode Output Voltages



- NOTES: A. The input pulse is supplied by a generator having the following characteristics: PRR = 1 MHz, $Z_O = 50 \Omega$, duty cycle = 50%, $t_f \leq 5 \text{ ns}$, $t_r \leq 5 \text{ ns}$.
 B. C_L includes probe and stray capacitance.

Figure 2. Differential Output Test Circuit and Voltage Waveforms

SN65ALS172A, SN75ALS172A QUADRUPLE DIFFERENTIAL LINE DRIVERS

SLLS121C – AUGUST 1990 – REVISED MAY 1995

PARAMETER MEASUREMENT INFORMATION

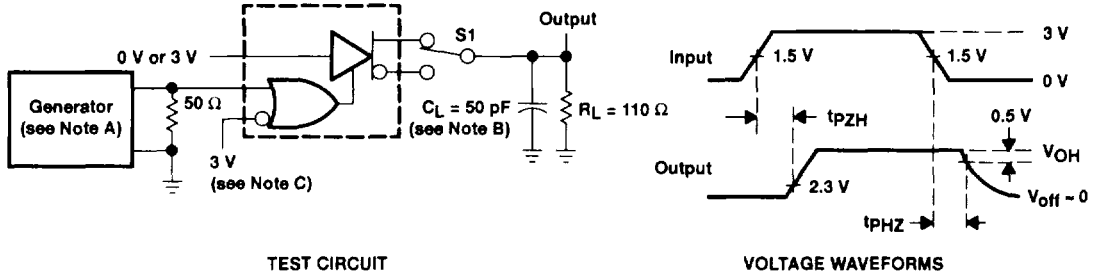

Figure 3. Test Circuit and Voltage Waveforms, t_{pZH} and t_{PHZ}

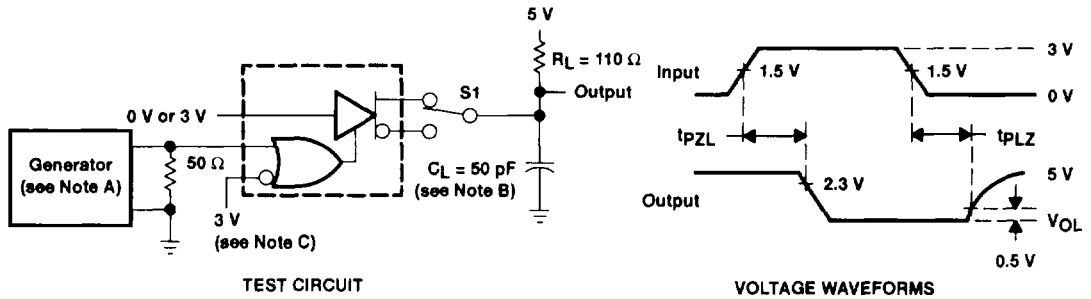

Figure 4. Test Circuit and Voltage Waveforms, t_{pZL} and t_{PLZ}

- NOTES:
- The input pulse is supplied by a generator having the following characteristics: PRR = 1 MHz, $Z_O = 50$ Ω, duty cycle = 50%, $t_f \leq 5$ ns, $t_r \leq 5$ ns.
 - C_L includes probe and stray capacitance.
 - To test the active-low enable \bar{G} , ground G and apply an inverted input waveform to \bar{G} .