

# MC74VHC244

## Octal Bus Buffer

The MC74VHC244 is an advanced high speed CMOS octal bus buffer fabricated with silicon gate CMOS technology.

The MC74VHC244 is a noninverting 3-state buffer, and has two active-low output enables. This device is designed to be used with 3-state memory address drivers, etc.

The internal circuit is composed of three stages, including a buffer output which provides high noise immunity and stable output. The inputs tolerate voltages up to 7 V, allowing the interface of 5 V systems to 3 V systems.

- High Speed:  $t_{PD} = 3.9 \text{ ns}$  (Typ) at  $V_{CC} = 5 \text{ V}$
- Low Power Dissipation:  $I_{CC} = 4 \mu\text{A}$  (Max) at  $T_A = 25^\circ\text{C}$
- High Noise Immunity:  $V_{NIH} = V_{NIL} = 28\% V_{CC}$
- Power Down Protection Provided on Inputs
- Balanced Propagation Delays
- Designed for 2 V to 5.5 V Operating Range
- Low Noise:  $V_{OLP} = 0.9 \text{ V}$  (Max)
- Pin and Function Compatible with Other Standard Logic Families
- Latchup Performance Exceeds 300 mA
- ESD Performance: Human Body Model > 2000 V  
Machine Model > 200 V
- Chip Complexity: 136 FETs
- Pb-Free Packages are Available\*

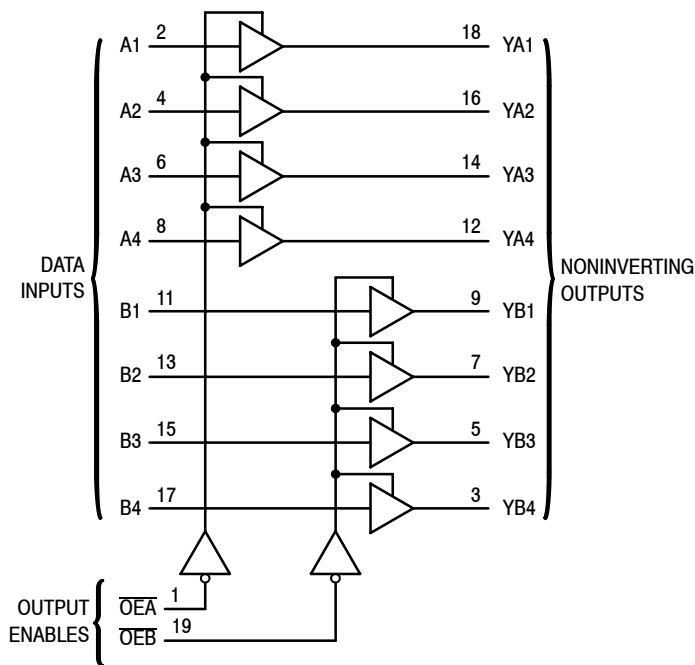

Figure 1. Logic Diagram



ON Semiconductor®

<http://onsemi.com>

### MARKING DIAGRAM

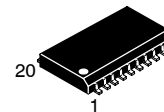

SOIC-20 WB  
DW SUFFIX  
CASE 751D

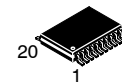
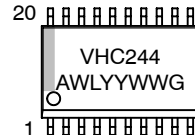

TSSOP-20  
DT SUFFIX  
CASE 948E

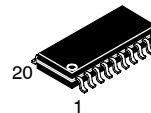
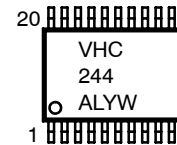

SOIC EIAJ-20  
M SUFFIX  
CASE 967

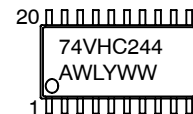

A = Assembly Location  
WL, L = Wafer Lot  
YY, Y = Year  
WW, W = Work Week

### PIN ASSIGNMENT

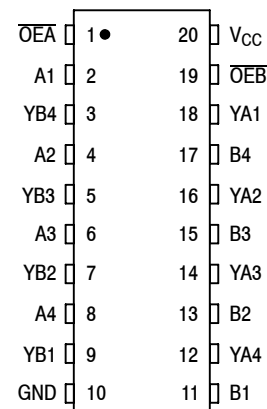

### ORDERING INFORMATION

See detailed ordering and shipping information in the Ordering Information Table on page 2 of this data sheet.

\*For additional information on our Pb-Free strategy and soldering details, please download the ON Semiconductor Soldering and Mounting Techniques Reference Manual, SOLDERRM/D.

# MC74VHC244

## FUNCTION TABLE

INPUTS		OUTPUTS
OE <sub>A</sub> , OE <sub>B</sub>	A, B	YA, YB
L	L	L
L	H	H
H	X	Z

## ORDERING INFORMATION

Device	Package	Shipping <sup>†</sup>
MC74VHC244DW - OBSOLETE*	SOIC-20 WB	38 Units/Rail
MC74VHC244DWR2	SOIC-20 WB	1000/Tape & Reel
MC74VHC244DT	TSSOP-20 (Pb-Free)	75 Units/Rail
MC74VHC244DTR2	TSSOP-20 (Pb-Free)	2500/Tape & Reel
MC74VHC244M - OBSOLETE*	SOIC EIAJ-20 (Pb-Free)	1600 Units/Box
MC74VHC244MEL	SOIC EIAJ-20 (Pb-Free)	2000/Tape & Reel

\*This device is obsolete, information available for reference.

†For information on tape and reel specifications, including part orientation and tape sizes, please refer to our Tape and Reel Packaging Specifications Brochure, BRD8011/D.

## MAXIMUM RATINGS (Note 1)

Symbol	Parameter	Value	Unit
V <sub>CC</sub>	Positive DC Supply Voltage	-0.5 to +7.0	V
V <sub>IN</sub>	Digital Input Voltage	-0.5 to +7.0	V
V <sub>OUT</sub>	DC Output Voltage	-0.5 to V <sub>CC</sub> +0.5	V
I <sub>IK</sub>	Input Diode Current	-20	mA
I <sub>OK</sub>	Output Diode Current	± 20	mA
I <sub>OUT</sub>	DC Output Current, per Pin	± 25	mA
I <sub>CC</sub>	DC Supply Current, V <sub>CC</sub> and GND Pins	± 75	mA
P <sub>D</sub>	Power Dissipation in Still Air	SOIC TSSOP 500 450	mW
T <sub>STG</sub>	Storage Temperature Range	-65 to +150	°C
V <sub>ESD</sub>	ESD Withstand Voltage	Human Body Model (Note 2) Machine Model (Note 3) Charged Device Model (Note 4) >2000 >200 >2000	V
I <sub>LATCHUP</sub>	Latchup Performance	Above V <sub>CC</sub> and Below GND at 125°C (Note 5)	± 300 mA
θ <sub>JA</sub>	Thermal Resistance, Junction-to-Ambient	SOIC TSSOP 96 128	°C/W

Stresses exceeding Maximum Ratings may damage the device. Maximum Ratings are stress ratings only. Functional operation above the Recommended Operating Conditions is not implied. Extended exposure to stresses above the Recommended Operating Conditions may affect device reliability.

1. V<sub>in</sub> and V<sub>out</sub> should be constrained to the range GND ≤ (V<sub>in</sub> or V<sub>out</sub>) ≤ V<sub>CC</sub>. Unused inputs must always be tied to an appropriate logic voltage level (e.g., either GND or V<sub>CC</sub>). Unused outputs must be left open.
2. Tested to EIA/JESD22-A114-A
3. Tested to EIA/JESD22-A115-A
4. Tested to JESD22-C101-A
5. Tested to EIA/JESD78

# MC74VHC244

## RECOMMENDED OPERATING CONDITIONS

Symbol	Characteristics	Min	Max	Unit		
V <sub>CC</sub>	DC Supply Voltage	2.0	5.5	V		
V <sub>IN</sub>	DC Input Voltage	0	5.5	V		
V <sub>OUT</sub>	DC Output Voltage	0	V <sub>CC</sub>	V		
T <sub>A</sub>	Operating Temperature Range, all Package Types	-55	125	°C		
t <sub>r</sub> , t <sub>f</sub>	Input Rise or Fall Time					
			V <sub>CC</sub> = 3.3 V ± 0.3 V	0	100	ns/V
			V <sub>CC</sub> = 5.0 V ± 0.5 V		20	

## DEVICE JUNCTION TEMPERATURE VERSUS TIME TO 0.1% BOND FAILURES

Junction Temperature °C	Time, Hours	Time, Years
80	1,032,200	117.8
90	419,300	47.9
100	178,700	20.4
110	79,600	9.4
120	37,000	4.2
130	17,800	2.0
140	8,900	1.0

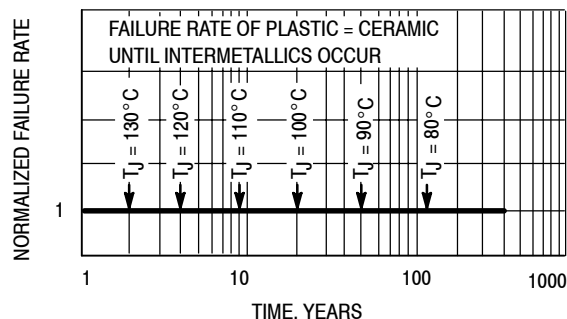

Figure 2. Failure Rate vs. Time Junction Temperature

## DC CHARACTERISTICS (Voltages Referenced to GND)

Symbol	Parameter	Condition	V <sub>CC</sub> (V)	T <sub>A</sub> = 25°C			T <sub>A</sub> ≤ 85°C		-55°C ≤ T <sub>A</sub> ≤ 125°C		Unit
				Min	Typ	Max	Min	Max	Min	Max	
V <sub>IH</sub>	Minimum High-Level Input Voltage		2.0 3.0 to 5.5	1.5 V <sub>CCX</sub> 0.7			1.5 V <sub>CCX</sub> 0.7	1.5 V <sub>CCX</sub> 0.7	1.5 V <sub>CCX</sub> 0.7		V
V <sub>IL</sub>	Maximum Low-Level Input Voltage		2.0 3.0 to 5.5			0.5 V <sub>CCX</sub> 0.3		0.5 V <sub>CCX</sub> 0.3		0.5 V <sub>CCX</sub> 0.3	V
V <sub>OH</sub>	Maximum High-Level Output Voltage	V <sub>IN</sub> = V <sub>IH</sub> or V <sub>IL</sub> I <sub>OH</sub> = -50 μA	2.0 3.0 4.5	1.9 2.9 4.4	2.0 3.0 4.5		1.9 2.9 4.4		1.9 2.9 4.4		V
		V <sub>IN</sub> = V <sub>IH</sub> or V <sub>IL</sub> I <sub>OH</sub> = -4 mA I <sub>OH</sub> = -8 mA	3.0 4.5	2.58 3.94			2.48 3.8		2.34 3.66		
V <sub>OL</sub>	Maximum Low-Level Output Voltage	V <sub>IN</sub> = V <sub>IH</sub> or V <sub>IL</sub> I <sub>OL</sub> = 50 μA	2.0 3.0 4.5		0.0 0.0 0.0	0.1 0.1 0.1		0.1 0.1 0.1		0.1 0.1 0.1	V
		V <sub>IN</sub> = V <sub>IH</sub> or V <sub>IL</sub> I <sub>OH</sub> = 4 mA I <sub>OH</sub> = 8 mA	3.0 4.5			0.36 0.36		0.44 0.44		0.52 0.52	
I <sub>IN</sub>	Input Leakage Current	V <sub>IN</sub> = 5.5 V or GND	0 to 5.5			±0.1		±1.0		±1.0	μA
I <sub>OZ</sub>	Maximum 3-State Leakage Current	V <sub>IN</sub> = V <sub>IH</sub> or V <sub>IL</sub> V <sub>OUT</sub> = V <sub>CC</sub> or GND	5.5			±0.25		±2.5		±2.5	μA
I <sub>CC</sub>	Maximum Quiescent Supply Current (per package)	V <sub>IN</sub> = V <sub>CC</sub> or GND	5.5			4.0		40.0		40.0	μA

# MC74VHC244

## AC ELECTRICAL CHARACTERISTICS (Input $t_r = t_f = 3.0$ ns)

Symbol	Parameter	Test Conditions	$T_A = 25^\circ\text{C}$			$T_A \leq 85^\circ\text{C}$		$-55^\circ\text{C} \leq T_A \leq 125^\circ\text{C}$		Unit
			Min	Typ	Max	Min	Max	Min	Max	
$t_{PLH}$ , $t_{PHL}$	Maximum Propagation Delay, A to YA or B to YB	$V_{CC} = 3.3 \pm 0.3$ V $C_L = 15$ pF		5.8	8.4	1.0	10.0	1.0	11.0	ns
		$C_L = 50$ pF		8.3	11.9	1.0	13.5	1.0	14.5	
		$V_{CC} = 5.0 \pm 0.5$ V $C_L = 15$ pF		3.9	5.5	1.0	6.5	1.0	7.5	
		$C_L = 50$ pF		5.4	7.5	1.0	8.5	1.0	9.5	
$t_{PZL}$ , $t_{PZH}$	Output Enable Time $\overline{OE}A$ to YA or $\overline{OE}B$ to YB	$V_{CC} = 3.3 \pm 0.3$ V $C_L = 15$ pF		6.6	10.6	1.0	12.5	1.0	13.5	ns
		$R_L = 1$ k $\Omega$ $C_L = 50$ pF		9.1	14.1	1.0	16.0	1.0	17.0	
		$V_{CC} = 5.0 \pm 0.5$ V $C_L = 15$ pF		4.7	7.3	1.0	8.5	1.0	9.5	
		$R_L = 1$ k $\Omega$ $C_L = 50$ pF		6.2	9.3	1.0	10.5	1.0	11.5	
$t_{PLZ}$ , $t_{PHZ}$	Output Disable Time $\overline{OE}A$ to YA or $\overline{OE}B$ to YB	$V_{CC} = 3.3 \pm 0.3$ V $C_L = 50$ pF		10.3	14.0	1.0	16.0	1.0	17.0	ns
		$R_L = 1$ k $\Omega$								
		$V_{CC} = 5.0 \pm 0.5$ V $C_L = 50$ pF		6.7	9.2	1.0	10.5	1.0	11.5	
		$R_L = 1$ k $\Omega$								
$t_{OSLH}$ , $t_{OSHL}$	Output to Output Skew	$V_{CC} = 3.3 \pm 0.3$ V $C_L = 50$ pF (Note 6)			1.5		1.5		1.5	ns
		$V_{CC} = 5.0 \pm 0.5$ V $C_L = 50$ pF (Note 6)			1.0		1.0		1.5	
$C_{in}$	Maximum Input Capacitance			4	10		10		10	pF
$C_{out}$	Maximum Three-State Output Capacitance (Output in High-Impedance State)			6						pF

$C_{PD}$	Power Dissipation Capacitance (Note 7)	Typical @ $25^\circ\text{C}$ , $V_{CC} = 5.0\text{V}$		pF
		19		

6. Parameter guaranteed by design.  $t_{OSLH} = |t_{PLHm} - t_{PLHn}|$ ,  $t_{OSHL} = |t_{PHLm} - t_{PHLn}|$ .

7.  $C_{PD}$  is defined as the value of the internal equivalent capacitance which is calculated from the operating current consumption without load. Average operating current can be obtained by the equation:  $I_{CC(OPR)} = C_{PD} \cdot V_{CC} \cdot f_{in} + I_{CC}/8$  (per bit).  $C_{PD}$  is used to determine the no-load dynamic power consumption;  $P_D = C_{PD} \cdot V_{CC}^2 \cdot f_{in} + I_{CC} \cdot V_{CC}$ .

## NOISE CHARACTERISTICS (Input $t_r = t_f = 3.0$ ns, $C_L = 50$ pF, $V_{CC} = 5.0$ V)

Symbol	Parameter	$T_A = 25^\circ\text{C}$		Unit
		Typ	Max	
$V_{OLP}$	Quiet Output Maximum Dynamic $V_{OL}$	0.6	0.9	V
$V_{OLV}$	Quiet Output Minimum Dynamic $V_{OL}$	-0.6	-0.9	V
$V_{IHD}$	Minimum High Level Dynamic Input Voltage		3.5	V
$V_{ILD}$	Maximum Low Level Dynamic Input Voltage		1.5	V

# MC74VHC244

## SWITCHING WAVEFORMS

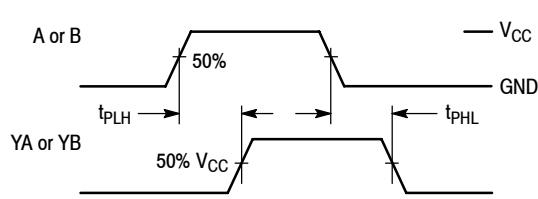

Figure 3. Switching Waveform

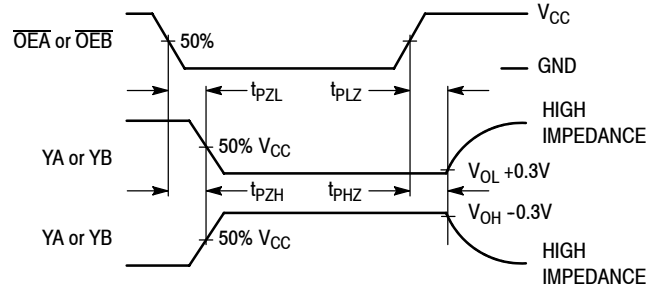
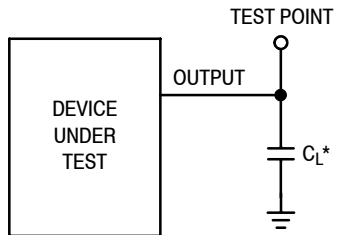

Figure 4. Switching Waveform

## TEST CIRCUITS



\*Includes all probe and jig capacitance

Figure 5. Test Circuit

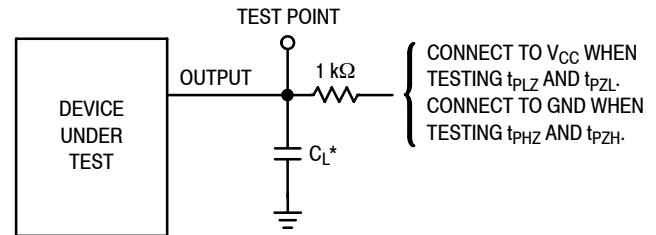

\*Includes all probe and jig capacitance

Figure 6. Test Circuit

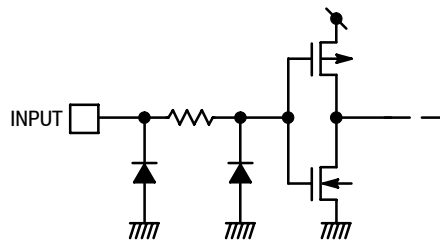
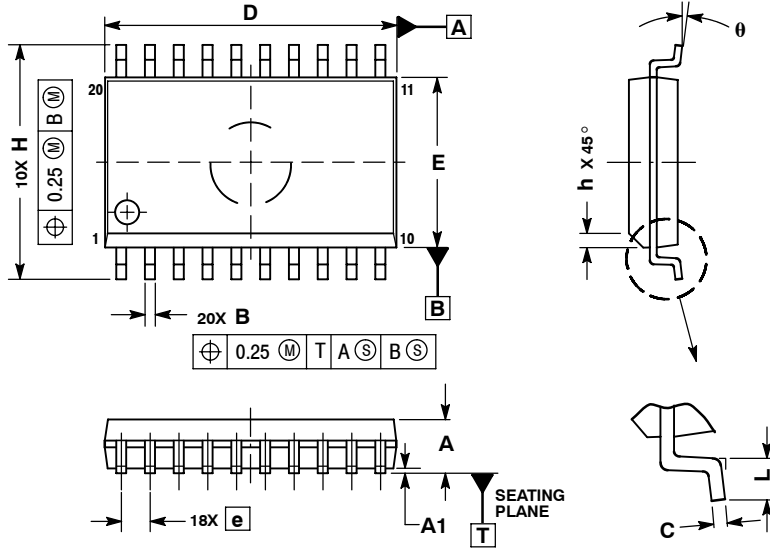

Figure 7. Input Equivalent Circuit

# MC74VHC244

## OUTLINE DIMENSIONS

SOIC-20 WB  
DW SUFFIX  
CASE 751D-05  
ISSUE G



**NOTES:**

1. DIMENSIONS ARE IN MILLIMETERS.
2. INTERPRET DIMENSIONS AND TOLERANCES PER ASME Y14.5M, 1994.
3. DIMENSIONS D AND E DO NOT INCLUDE MOLD PROTRUSION.
4. MAXIMUM MOLD PROTRUSION 0.15 PER SIDE.
5. DIMENSION B DOES NOT INCLUDE DAMBAR PROTRUSION. ALLOWABLE PROTRUSION SHALL BE 0.13 TOTAL IN EXCESS OF B DIMENSION AT MAXIMUM MATERIAL CONDITION.

DIM	MILLIMETERS	
	MIN	MAX
A	2.35	2.65
A1	0.10	0.25
B	0.35	0.49
C	0.23	0.32
D	12.65	12.95
E	7.40	7.60
e	1.27 BSC	
H	10.05	10.55
h	0.25	0.75
L	0.50	0.90
θ	0°	7°

TSSOP-20  
DT SUFFIX  
CASE 948E-02  
ISSUE B

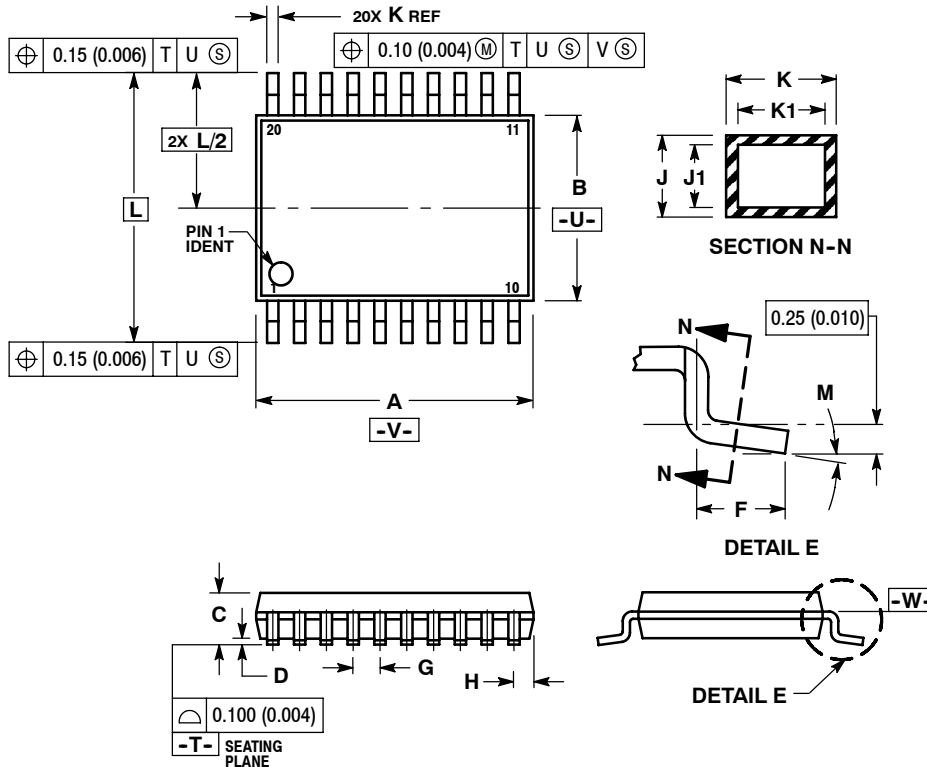

**NOTES:**

1. DIMENSIONING AND TOLERANCING PER ANSI Y14.5M, 1982.
2. CONTROLLING DIMENSION: MILLIMETER.
3. DIMENSION A DOES NOT INCLUDE MOLD FLASH, PROTRUSIONS OR GATE BURRS. MOLD FLASH OR GATE BURRS SHALL NOT EXCEED 0.15 (0.006) PER SIDE.
4. DIMENSION B DOES NOT INCLUDE INTERLEAD FLASH OR PROTRUSION. INTERLEAD FLASH OR PROTRUSION SHALL NOT EXCEED 0.25 (0.010) PER SIDE.
5. DIMENSION K DOES NOT INCLUDE DAMBAR PROTRUSION. ALLOWABLE DAMBAR PROTRUSION SHALL BE 0.08 (0.003) TOTAL IN EXCESS OF THE K DIMENSION AT MAXIMUM MATERIAL CONDITION.
6. TERMINAL NUMBERS ARE SHOWN FOR REFERENCE ONLY.
7. DIMENSION A AND B ARE TO BE DETERMINED AT DATUM PLANE -W-.

DIM	MILLIMETERS		INCHES	
	MIN	MAX	MIN	MAX
A	6.40	6.60	0.252	0.260
B	4.30	4.50	0.169	0.177
C	---	1.20	---	0.047
D	0.05	0.15	0.002	0.006
F	0.50	0.75	0.020	0.030
G	0.65 BSC		0.026 BSC	
H	0.27	0.37	0.011	0.015
J	0.09	0.20	0.004	0.008
J1	0.09	0.16	0.004	0.006
K	0.19	0.30	0.007	0.012
K1	0.19	0.25	0.007	0.010
L	6.40 BSC		0.252 BSC	
M	0°	8°	0°	8°

# MC74VHC244

## OUTLINE DIMENSIONS

SOIC EIAJ-20  
M SUFFIX  
CASE 967-01  
ISSUE O

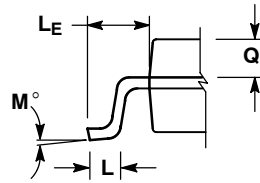
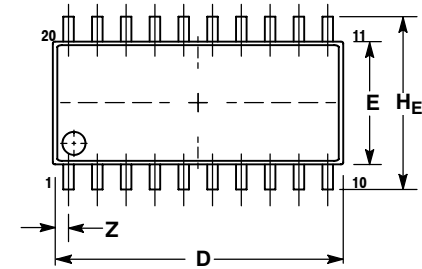

DETAIL P

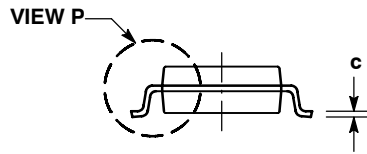
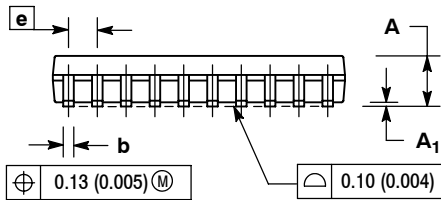

NOTES:

1. DIMENSIONING AND TOLERANCING PER ANSI Y14.5M, 1982.
2. CONTROLLING DIMENSION: MILLIMETER.
3. DIMENSIONS D AND E DO NOT INCLUDE MOLD FLASH OR PROTRUSIONS AND ARE MEASURED AT THE PARTING LINE. MOLD FLASH OR PROTRUSIONS SHALL NOT EXCEED 0.15 (0.006) PER SIDE.
4. TERMINAL NUMBERS ARE SHOWN FOR REFERENCE ONLY.
5. THE LEAD WIDTH DIMENSION (b) DOES NOT INCLUDE DAMBAR PROTRUSION. ALLOWABLE DAMBAR PROTRUSION SHALL BE 0.08 (0.003) TOTAL IN EXCESS OF THE LEAD WIDTH DIMENSION AT MAXIMUM MATERIAL CONDITION. DAMBAR CANNOT BE LOCATED ON THE LOWER RADIUS OR THE FOOT. MINIMUM SPACE BETWEEN PROTRUSIONS AND ADJACENT LEAD TO BE 0.46 (0.018).

DIM	MILLIMETERS		INCHES	
	MIN	MAX	MIN	MAX
A	---	2.05	---	0.081
A <sub>1</sub>	0.05	0.20	0.002	0.008
b	0.35	0.50	0.014	0.020
c	0.18	0.27	0.007	0.011
D	12.35	12.80	0.486	0.504
E	5.10	5.45	0.201	0.215
e	1.27 BSC		0.050 BSC	
H <sub>E</sub>	7.40	8.20	0.291	0.323
L	0.50	0.85	0.020	0.033
L <sub>E</sub>	1.10	1.50	0.043	0.059
M	0°	10°	0°	10°
Q <sub>1</sub>	0.70	0.90	0.028	0.035
Z	---	0.81	---	0.032

# MC74VHC244

**ON Semiconductor** and  are registered trademarks of Semiconductor Components Industries, LLC (SCILLC). SCILLC reserves the right to make changes without further notice to any products herein. SCILLC makes no warranty, representation or guarantee regarding the suitability of its products for any particular purpose, nor does SCILLC assume any liability arising out of the application or use of any product or circuit, and specifically disclaims any and all liability, including without limitation special, consequential or incidental damages. "Typical" parameters which may be provided in SCILLC data sheets and/or specifications can and do vary in different applications and actual performance may vary over time. All operating parameters, including "Typicals" must be validated for each customer application by customer's technical experts. SCILLC does not convey any license under its patent rights nor the rights of others. SCILLC products are not designed, intended, or authorized for use as components in systems intended for surgical implant into the body, or other applications intended to support or sustain life, or for any other application in which the failure of the SCILLC product could create a situation where personal injury or death may occur. Should Buyer purchase or use SCILLC products for any such unintended or unauthorized application, Buyer shall indemnify and hold SCILLC and its officers, employees, subsidiaries, affiliates, and distributors harmless against all claims, costs, damages, and expenses, and reasonable attorney fees arising out of, directly or indirectly, any claim of personal injury or death associated with such unintended or unauthorized use, even if such claim alleges that SCILLC was negligent regarding the design or manufacture of the part. SCILLC is an Equal Opportunity/Affirmative Action Employer. This literature is subject to all applicable copyright laws and is not for resale in any manner.

## PUBLICATION ORDERING INFORMATION

### LITERATURE FULFILLMENT:

Literature Distribution Center for ON Semiconductor  
P.O. Box 61312, Phoenix, Arizona 85082-1312 USA

**Phone:** 480-829-7710 or 800-344-3860 Toll Free USA/Canada

**Fax:** 480-829-7709 or 800-344-3867 Toll Free USA/Canada

**Email:** [orderlit@onsemi.com](mailto:orderlit@onsemi.com)

**N. American Technical Support:** 800-282-9855 Toll Free  
USA/Canada

**Japan:** ON Semiconductor, Japan Customer Focus Center  
2-9-1 Kamimeguro, Meguro-ku, Tokyo, Japan 153-0051  
**Phone:** 81-3-5773-3850

**ON Semiconductor Website:** <http://onsemi.com>

**Order Literature:** <http://www.onsemi.com/litorder>

For additional information, please contact your  
local Sales Representative.