

MAX17127

Six-String WLED Driver with Integrated Step-Up Converter

General Description

The MAX17127 is a high-efficiency driver for white light-emitting diodes (LEDs). It is designed for large liquid-crystal displays (LCDs) that employ an array of LEDs as the light source. An internal switch current-mode step-up converter drives the LED array, which can be configured for up to six strings in parallel and 13 LEDs per string. Each string is terminated with ballast that achieves $\pm 2\%$ current-regulation accuracy, ensuring even LED brightness. The MAX17127 has a wide input voltage range from 5V to 26V, and provides adjustable 10mA to 30mA full-scale LED current.

The MAX17127 can implement brightness control through the PWM signal input, and LED current is directly controlled by the external dimming signal's frequency and duty cycle.

The MAX17127 has multiple features to protect the controller from fault conditions. Once an open/short string is detected, the fault string is disabled while other strings can still operate normally. The controller features cycle-by-cycle current limit to provide constant operation and soft-start capability. If the MAX17127 is in current-limit condition, the step-up converter is latched off after an internal timer expires. A thermal-shutdown circuit provides another level of protection. When thermal shutdown happens, the MAX17127 is latched off.

The MAX17127's step-up controller features an internal 0.12Ω (typ), 48V (max) power MOSFET with local current-sense amplifier for accurate cycle-by-cycle current limit. This architecture greatly simplifies the external circuitry and saves PCB space. Low-feedback voltage at each LED string helps reduce power loss and improve efficiency. The MAX17127 features resistor-adjustable switching frequency from 250kHz to 1MHz, which enables a wide variety of applications that can trade off component size for operating frequency.

The MAX17127 is available in a thermally enhanced, lead-free, 20-pin, 4mm x 4mm thin QFN package.

Features

- 5V to 26V Input Supply Voltage
- Up to Six Parallel Strings Multiple Series-Connected LEDs
- 250kHz to 1MHz Adjustable Switching Frequency
- 0.12Ω Internal HV Power MOSFET (48V max)
- Low String Feedback Voltage: 480mV at 20mA LED Current
- Full-Scale LED Current Adjustable from 10mA to 30mA
- $\pm 2\%$ Current-Regulation Accuracy Between Strings
- 400ns Minimum String On-Time
- 100Hz to 25kHz PWM Input Range
- Open and Short LED Protection
- Output Overvoltage Protection
- Thermal Shutdown
- Small 20-Pin, 4mm x 4mm Thin QFN Package

Ordering Information

PART	TEMP RANGE	PIN-PACKAGE
MAX17127ETP+	-40°C to +85°C	20 TQFN-EP*

+Denotes a lead(Pb)-free/RoHS-compliant package.

*EP = Exposed pad.

Applications

- Notebook, Subnotebook, and Tablet Computer Displays
- Handy Terminals

Simplified Operating Circuit appears at end of data sheet.

Absolute Maximum Ratings

V_{IN} to AGND-0.3V to +30V
 FB₋, SW to PGND-0.3V to +52V
 PGND to AGND.....-0.3V to +0.3V
 V_{DDIO}, PWM, EN, FPO, I.C. to AGND.....-0.3V to +6V
 COMP, ISET, R_{FPWM}, OVP, FSLCT to AGND -0.3V to V_{DDIO} + 0.3V
 SW Switch Maximum Continuous RMS Current..... 1.6A
 Continuous Power Dissipation (T_A = +70°C)
 TQFN (derate 16.9mW/NC above +70°C) 1349mW

Operating Temperature Range..... -40°C to +85°C
 Junction Temperature..... +150°C
 Storage Temperature Range..... -60°C to +150°C
 ESD
 HBM.....2kV
 MM.....200V
 Lead Temperature (soldering, 10s)+300°C
 Soldering Temperature (reflow).....+260°C

Stresses beyond those listed under “Absolute Maximum Ratings” may cause permanent damage to the device. These are stress ratings only, and functional operation of the device at these or any other conditions beyond those indicated in the operational sections of the specifications is not implied. Exposure to absolute maximum rating conditions for extended periods may affect device reliability.

Electrical Characteristics

(Circuit of Figure 1. V_{IN} = 12V, C_{COMP} = 0.51nF, C_{COU}T = 4.7μF, R_{COMP} = 82.5kΩ, R_{ISET} = 180kΩ, R_{FSLCT} = 100kΩ, L = 10μH, T_A = 0°C to +85°C, unless otherwise noted. Typical values are at T_A = +25°C.)

PARAMETER	CONDITIONS	MIN	TYP	MAX	UNITS
V _{IN} Input Voltage Range		5		26	V
V _{IN} Quiescent Current	MAX17127 is enabled, V _{EN} = 3.3V, V _{IN} = 26V		2.7	3.2	mA
	MAX17127 is disabled, EN = AGND		5	10	μA
V _{DDIO} Output Voltage	MAX17127 is enabled, V _{EN} = 3.3V, 5.4V < V _{IN} < 26V, 0A < I _{VDDIO} < 10mA	4.85	5	5.15	V
	MAX17127 is enabled, V _{EN} = 3.3V, V _{IN} = 5V, I _{VDDIO} = 10mA, dropout condition	4.6	4.75		
	MAX17127 is disabled, EN = AGND, 0A < I _{VDDIO} < 50μA	3.1	3.7	4.1	V
V _{DDIO} Current Limit	V _{DDIO} is forced to 4.2V	25	45	70	mA
V _{DDIO} UVLO Threshold	Rising edge, typical hysteresis = 250mV	3.90	4.00	4.10	V
V _{IN} UVLO Threshold	Falling edge	4.3	4.5	4.7	V
	Rising edge	4.55	4.75	4.95	
BOOST CONVERTER					
SW On-Resistance	20mA from SW to PGND		0.12	0.25	Ω
SW Leakage Current	40V on SW, T _A = +25°C			1	μA
Operating Frequency	R _{FSLCT} = 100kΩ	0.95	1.0	1.05	MHz
	R _{FSLCT} = 400kΩ	0.225	0.25	0.275	
R _{FSLCT} Range	Operating range	90		500	kΩ
Maximum Duty Cycle	At f _{SW} = 1MHz	91	95		%
Minimum On-Time	(Note 1)		50	80	ns
SW Current Limit	Duty cycle = 75%	3.12	3.9	4.7	A
CONTROL INPUT					
PWM, EN Logic-Input High Level		2.1			V
PWM, EN Logic-Input Low Level				0.8	V
EN Pulldown Resistor		120	200	280	kΩ

Electrical Characteristics (continued)

(Circuit of Figure 1. $V_{IN} = 12V$, $C_{COMP} = 0.51nF$, $C_{COU} = 4.7\mu F$, $R_{COMP} = 82.5k\Omega$, $R_{ISET} = 180k\Omega$, $R_{FSLCT} = 100k\Omega$, $L = 10\mu H$, $T_A = 0^\circ C$ to $+85^\circ C$, unless otherwise noted. Typical values are at $T_A = +25^\circ C$.)

PARAMETER	CONDITIONS	MIN	TYP	MAX	UNITS
FPO OUTPUT					
FPO Off-Leakage Current	Fault inactive, $T_A = +25^\circ C$			100	nA
FPO On Output-Voltage Low	$I_{SINK} = 1mA$, fault active			0.4	V
INPUT LEAKAGE					
PWM Leakage Current	$T_A = +25^\circ C$, $V_{PWM} = 0V$, $V_{PWM} = 5V$	-1		+1	μA
OVP Leakage Current	$T_A = +25^\circ C$, $V_{OVP} = 0V$, $V_{OVP} = 5V$	-0.1		+0.1	μA
LED CURRENT					
Full-Scale FB_ Output Current	$R_{ISET} = 120k\Omega$	29.1	30	30.9	mA
	$R_{ISET} = 180k\Omega$	19.6	20	20.4	
	$R_{ISET} = 360k\Omega$	9.7	10	10.3	
	$V_{ISET} < 0.7V$	0.2	0.3	0.4	
R_{ISET} Range	Operating range	100		400	k Ω
	Accuracy = 3%	120		360	
Current Regulation Between Strings	$10mA < I_{FB_} < 30mA$	-2.0		+2.0	%
Minimum FB_ Regulation Voltage	$I_{FB_} = 30mA$	400	555	770	mV
	$I_{FB_} = 20mA$		460	670	
	$I_{FB_} = 10mA$		350	630	
FB_ On-Resistance	$V_{FB_} = 50mV$ (includes 10Ω sense resistor)		17.5	28.4	Ω
FB_ Bias Current	$V_{FB_} = 40V$, $T_A = +25^\circ C$		0.1	1	μA
FB_ Minimum On-Time		400	580	700	ns
FAULT PROTECTION					
OVP Threshold Voltage	Rising edge, typical hysteresis = 90mV	1.23	1.25	1.27	V
FB_ Overvoltage Threshold		7	8	9	V
FB_ Enable Threshold Voltage			1.2		V
FB_ Open Threshold Voltage		130		280	mV
FB_ Check LED Source Current		0.4		1.3	mA
FB_ Check LED Time		0.7	1.0	1.3	ms
Thermal-Shutdown Threshold	(Note 1)		+150		$^\circ C$
Overcurrent Fault Timer	Latchoff timer		128		μs
PWM CONTROL					
PWM Input On-Time		400			ns
PWM Input Frequency Range		0.1		25	kHz

Electrical Characteristics

(Circuit of Figure 1. $V_{IN} = 12V$, $C_{COMP} = 0.51nF$, $C_{COUT} = 4.7\mu F$, $R_{COMP} = 82.5k\Omega$, $R_{ISET} = 180k\Omega$, $R_{FSLCT} = 100k\Omega$, $L = 10\mu H$, $T_A = 0^\circ C$ to $+85^\circ C$, unless otherwise noted. Typical values are at $T_A = +25^\circ C$.)

PARAMETER	CONDITIONS	MIN	TYP	MAX	UNITS
V_{IN} Input Voltage Range		5		26	V
V_{IN} Quiescent Current	MAX17127 is enabled, $V_{EN} = 3.3V$, $V_{IN} = 26V$			3.2	mA
	MAX17127 is disabled, EN = AGND			15	μA
V_{DDIO} Output Voltage	MAX17127 is enabled, $V_{EN} = 3.3V$, $5.4V < V_{IN} < 26V$, $0A < I_{VDDIO} < 10mA$	4.85		5.15	V
	MAX17127 is enabled, $V_{EN} = 3.3V$, $V_{IN} = 5V$, $I_{VDDIO} = 10mA$, dropout condition	4.6			
	EN = AGND, $0A < I_{VDDIO} < 50\mu A$	3.1		4.1	
V_{DDIO} Current Limit	V_{DDIO} is forced to 4.2V	25		70	mA
V_{DDIO} UVLO Threshold	Rising edge, typical hysteresis = 250mV	3.90		4.10	V
V_{IN} UVLO Threshold	Falling edge	4.3		4.7	V
	Rising edge	4.55		4.95	
BOOST CONVERTER					
SW On-Resistance	20mA from SW to PGND			0.25	Ω
SW Leakage Current	40V on SW, $T_A = +25^\circ C$			1	μA
Operating Frequency	$R_{FSLCT} = 100k\Omega$	0.95		1.05	MHz
	$R_{FSLCT} = 400k\Omega$	0.225		0.28	
R_{FSLCT} Operative Range		90		500	k Ω
Maximum Duty Cycle	At $f_{SW} = 1MHz$	92			%
Boost Output Voltage	With suitable OVP network			45	V
Minimum On-Time	(Note 1)			80	ns
CONTROL INPUT					
PWM, EN Logic-Input High Level		2.1			V
PWM, EN Logic-Input Low Level				0.8	V
EN Pull-down Resistor		110		290	k Ω
FPO OUTPUT					
FPO On Output-Voltage Low	$I_{SINK} = 1mA$, fault active			0.4	V
LED CURRENT					
Full-Scale FB_ Output Current	$R_{ISET} = 120k\Omega$	29.1		30.9	mA
	$R_{ISET} = 180k\Omega$	19.4		20.6	
	$R_{ISET} = 360k\Omega$	9.7		10.3	
	$V_{ISET} < 0.7V$	0.2		0.4	
R_{ISET} Range	Operating range	100		400	k Ω
	Accuracy = 3%	120		360	
Current Regulation Between Strings	$10mA < I_{FB_} < 30mA$	-2.0		+2.0	%

Electrical Characteristics (continued)

(Circuit of Figure 1. $V_{IN} = 12V$, $C_{COMP} = 0.51nF$, $C_{COUT} = 4.7\mu F$, $R_{COMP} = 82.5k\Omega$, $R_{ISET} = 180k\Omega$, $R_{FSLCT} = 100k\Omega$, $L = 10\mu H$, $T_A = 0^\circ C$ to $+85^\circ C$, unless otherwise noted. Typical values are at $T_A = +25^\circ C$.)

PARAMETER	CONDITIONS	MIN	TYP	MAX	UNITS
Minimum FB_Regulation Voltage	$I_{FB} = 30mA$	400		770	mV
	$I_{FB} = 20mA$			670	
	$I_{FB} = 10mA$			630	
FB_On-Resistance	$V_{FB} = 50mV$ (includes 10Ω sense resistor)			28.4	Ω
FB_Bias Current	$V_{FB} = 40V$, $T_A = +25^\circ C$			1	μA
FB_Minimum On-Time		400		700	ns
FAULT PROTECTION					
OVP Threshold Voltage	Rising edge, typical hysteresis = 90mV	1.23		1.27	V
FB_Overvoltage Threshold		7		9	V
FB_Open Threshold Voltage		130		280	mV
FB_Check LED Source Current		0.4		1.3	mA
FB_Check LED Time		0.7		1.3	ms
Overcurrent Fault Timer	Latchoff timer	88		168	μs
PWM CONTROL					
PWM Input On-Time		400			ns
PWM Input Frequency Range		0.1		25	kHz

Note 1: Specifications are guaranteed by design, not production tested.

Typical Operating Characteristics

(Circuit of Figure 1. $V_{IN} = 12V$, $T_A = +25^\circ C$, unless otherwise noted.)

BOOST CONVERTER EFFICIENCY vs. INPUT VOLTAGE (V_S)
($V_{OUT} = 32V$, $I_{OUT} = 120mA$, BRIGHTNESS = 100%)

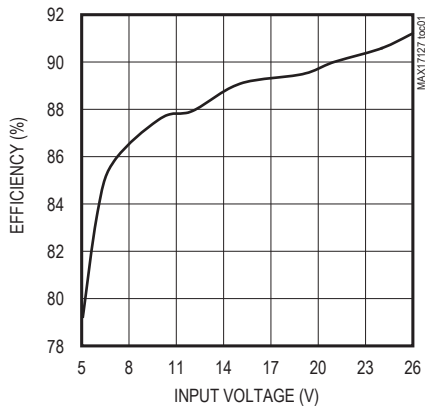

BOOST CONVERTER EFFICIENCY vs. BRIGHTNESS
($V_S = 2V$, $V_{OUT} = 32V$, $I_{OUT} = 120mA$ AT 100%)

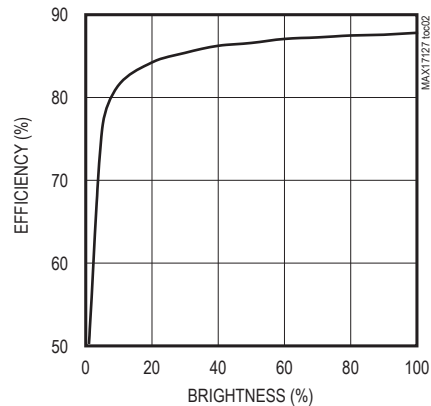

Typical Operating Characteristics (continued)

(Circuit of Figure 1. $V_{IN} = 12V$, $T_A = +25^{\circ}C$, unless otherwise noted.)

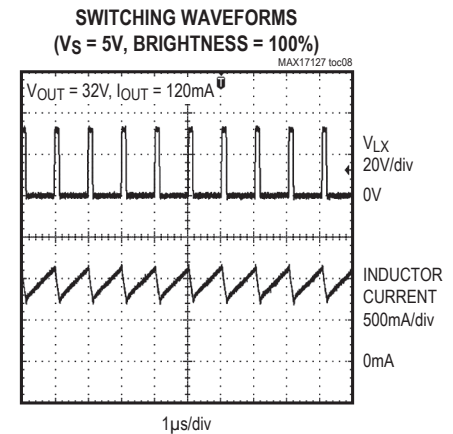
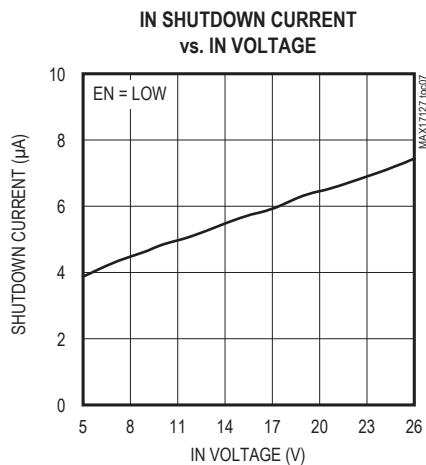
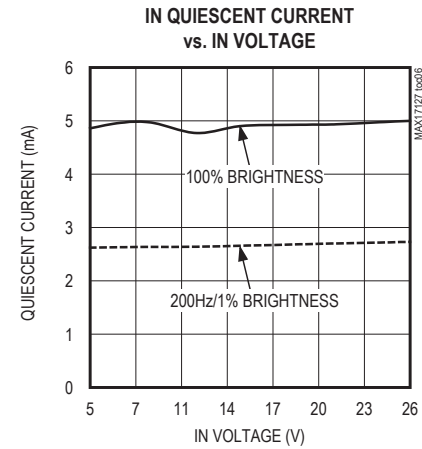
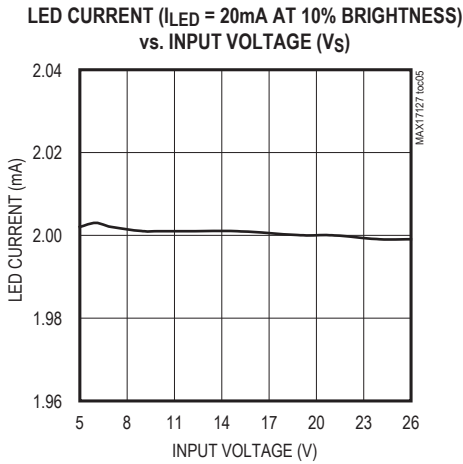
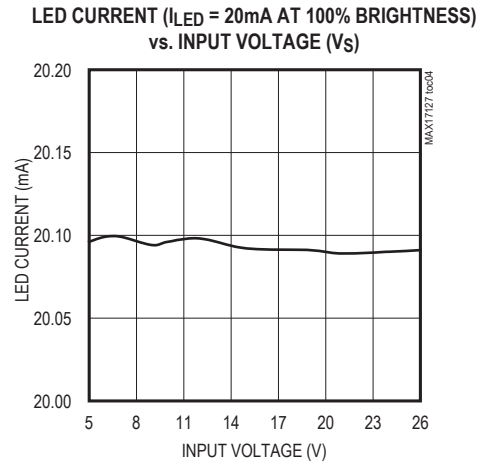
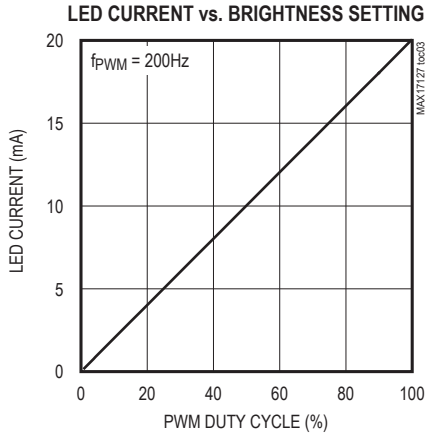

Typical Operating Characteristics (continued)

(Circuit of Figure 1. $V_{IN} = 12V$, $T_A = +25^\circ C$, unless otherwise noted.)

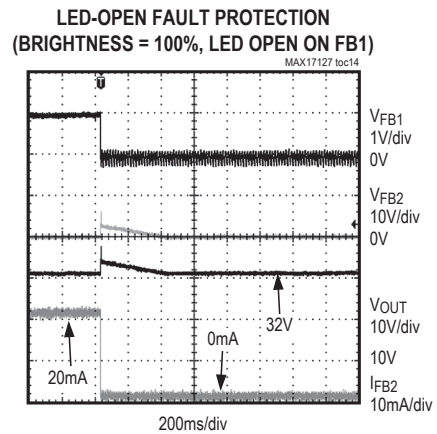
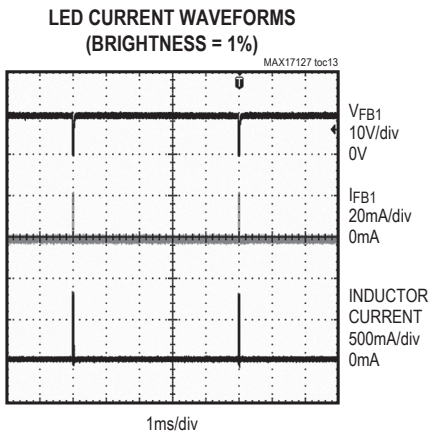
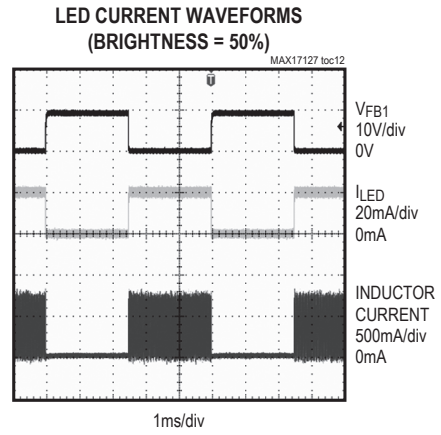
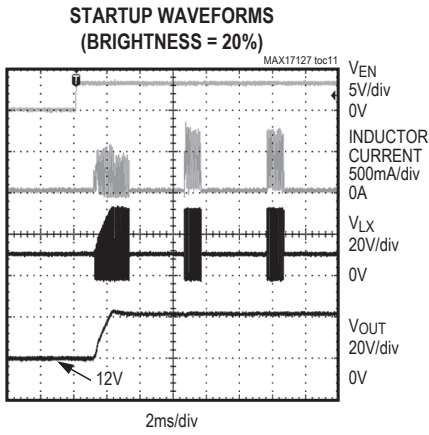
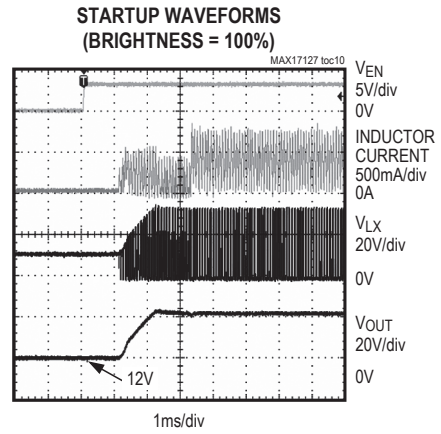
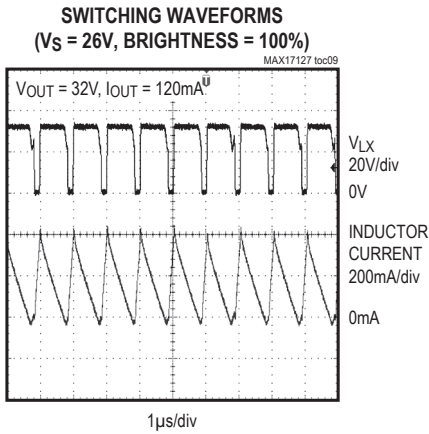

Typical Operating Characteristics (continued)

(Circuit of Figure 1. $V_{IN} = 12V$, $T_A = +25^\circ C$, unless otherwise noted.)

LED-SHORT FAULT PROTECTION
(BRIGHTNESS = 100%, 3 LEDs SHORT ON FB1)

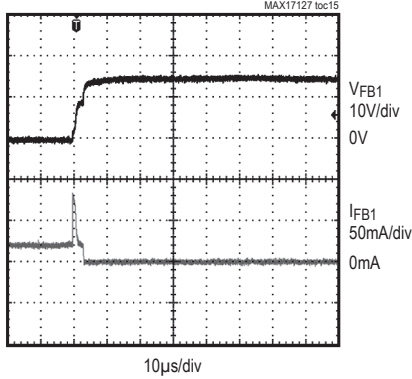

LINE-TRANSIENT RESPONSE
($V_S = 9V \rightarrow 21V$, BRIGHTNESS = 100%)

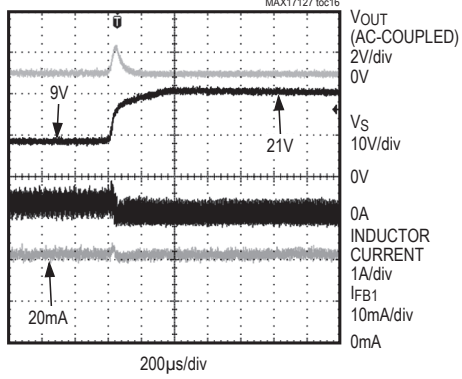

LINE-TRANSIENT RESPONSE
($V_S = 21V \rightarrow 9V$, BRIGHTNESS = 100%)

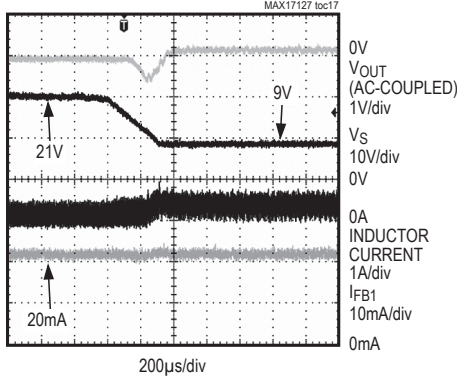

MAXIMUM UNBALANCE RATE BETWEEN STRING
vs. BRIGHTNESS ($V_S = 12V$, $I_{LED} = 20mA$)

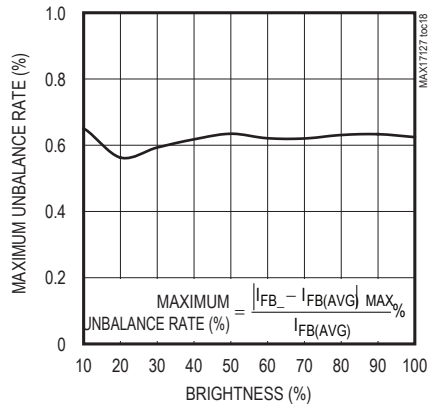

MAXIMUM UNBALANCE RATE BETWEEN STRINGS
($I_{LED} = 20mA$) vs. INPUT VOLTAGE (V_S)

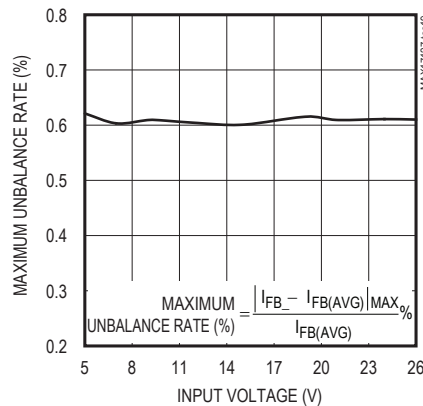

Pin Configuration

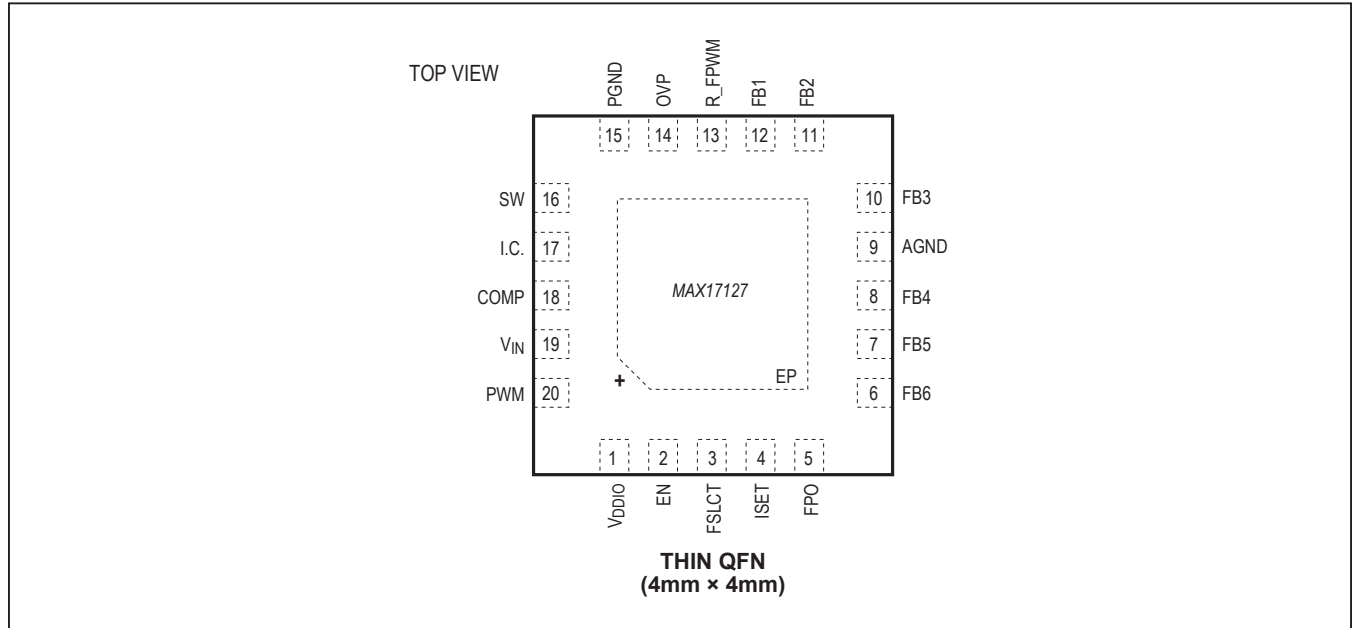

Pin Description

PIN	NAME	FUNCTION
1	V _{DDIO}	5V Linear Regulator Output. V _{DDIO} provides power to the MAX17127. Bypass V _{DDIO} to AGND with a ceramic capacitor of 1µF or greater.
2	EN	Enable Pin. EN = high enables the MAX17127. An internal 200k Ω (typ) pull-down resistor keeps the MAX17127 in disabled mode if the EN pin is high impedance.
3	FSLCT	Oscillator Frequency-Adjustment Pin. The resistance from FSLCT to AGND sets the step-up converter's oscillator frequency: $f_{SW} = 1\text{MHz} \times 100\text{k}\Omega / R_{FSLCT}$ The acceptable resistance range is 100k Ω < R _{FSLCT} < 400k Ω , which corresponds to the switching frequency of 1MHz > f _{SW} > 250kHz.
4	ISET	Full-Scale LED Current-Adjustment Pin. The resistance from ISET to AGND controls the full-scale current in each LED string: $I_{LED\text{MAX}} = 20\text{mA} \times 180\text{k}\Omega / R_{ISET}$ The acceptable resistance range is 120k Ω < R _{ISET} < 360k Ω , which corresponds to a full-scale LED current of 30mA > I _{LEDMAX} > 10mA. Connecting ISET to AGND sets the test mode for 0.3mA (typ) full-scale LED current.
5	FPO	Fault-Diagnostic Output. Open drain, active low. The FPO output is asserted low when the following faults occur: overcurrent fault, thermal fault, output-voltage short condition, or output overvoltage.
6	FB6	LED String 6 Cathode Connection. FB6 is the open-drain output of an internal regulator, which controls current through FB6. FB6 can sink up to 30mA. If unused, connect FB6 to AGND.

Pin Description (continued)

PIN	NAME	FUNCTION
7	FB5	LED String 5 Cathode Connection. FB5 is the open-drain output of an internal regulator, which controls current through FB5. FB5 can sink up to 30mA. If unused, connect FB5 to AGND.
8	FB4	LED String 4 Cathode Connection. FB4 is the open-drain output of an internal regulator, which controls current through FB4. FB4 can sink up to 30mA. If unused, connect FB4 to AGND.
9	AGND	Analog Ground
10	FB3	LED String 3 Cathode Connection. FB3 is the open-drain output of an internal regulator, which controls current through FB3. FB3 can sink up to 30mA. If unused, connect FB3 to AGND.
11	FB2	LED String 2 Cathode Connection. FB2 is the open-drain output of an internal regulator, which controls current through FB2. FB2 can sink up to 30mA. If unused, connect FB2 to AGND.
12	FB1	LED String 1 Cathode Connection. FB1 is the open-drain output of an internal regulator, which controls current through FB1. FB1 can sink up to 30mA. If unused, connect FB1 to AGND.
13	R_FPWM	Connect R_FPWM to AGND
14	OVP	Overvoltage Sense. Connect OVP to the boost converter output through a resistor: $V_{OVP} = 1.25V \times (1 + R_1/R_2)$
15	PGND	Boost Regulator Power Ground
16	SW	Boost Regulator Power Switch Node
17	I.C.	Internal Connection. Not connected externally.
18	COMP	Step-Up Converter Compensation Pin. Connect a ceramic capacitor in series with a resistor from COMP to AGND.
19	V _{IN}	Supply Input. V _{IN} biases the internal 5V linear regulator that powers the device. Bypass V _{IN} to AGND directly at the pin with a 0.1Fμ or greater ceramic capacitor.
20	PWM	PWM Signal Input. This signal is used for brightness control. The brightness is proportional to the PWM duty cycle, and the PWM signal directly controls the LED turning on/off.
—	EP	Exposed Backside Pad. Solder to the circuit board ground plane with sufficient copper connection to ensure low thermal resistance. See the <i>PCB Layout Guidelines</i> section.

Typical Operating Circuit

The MAX17127 typical operating circuit is shown as Figure 1. Table 1 lists some recommended components,

and Table 2 lists the contact information for component suppliers.

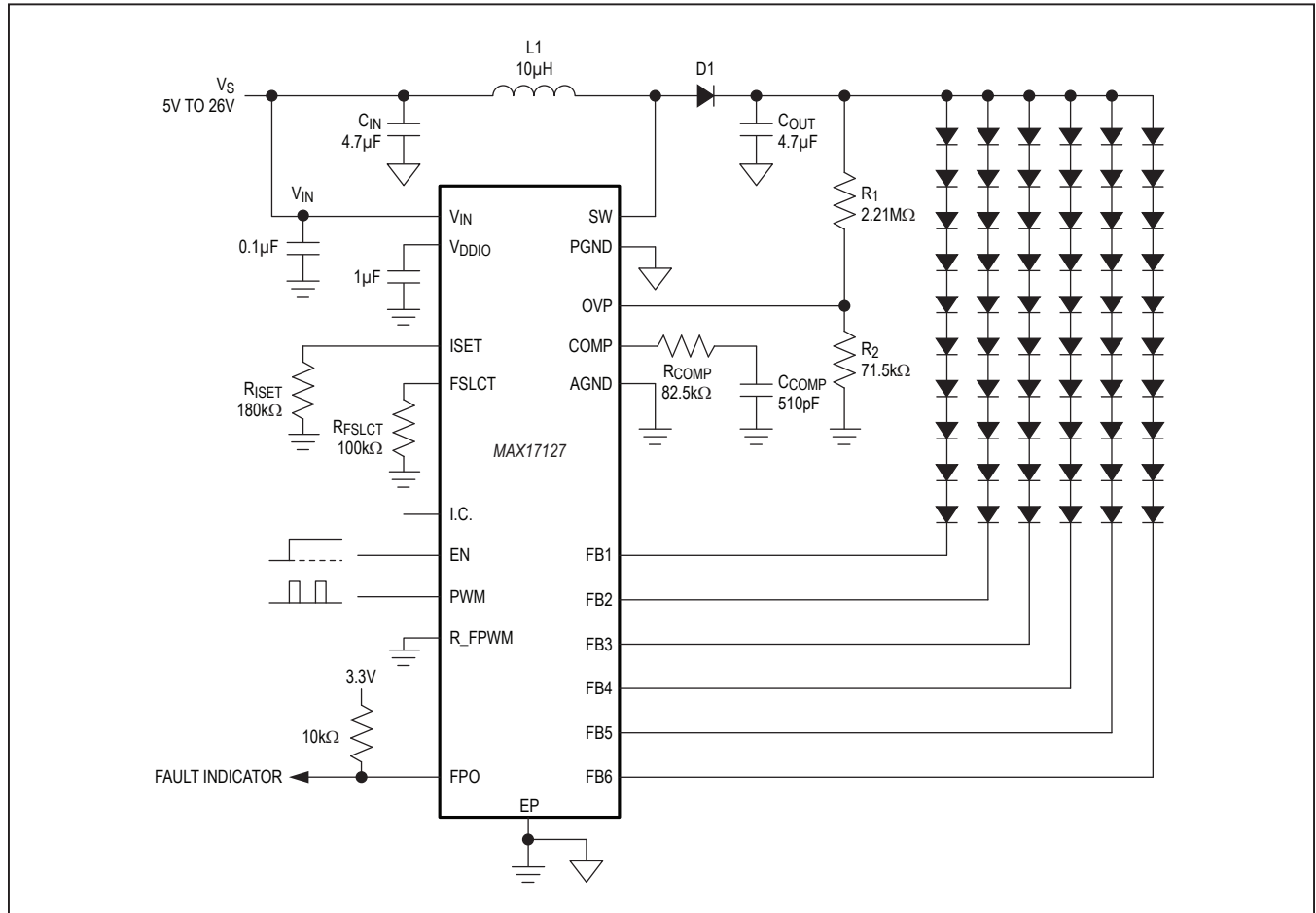

Figure 1. Typical Operating Circuit

Table 1. Component List

DESIGNATION	DESCRIPTION
C _{IN}	4.7µF ±10%, 25V X5R ceramic capacitor (1206) Murata GRM319R61E475KA12D
C1, C2	2.2µF ±20%, 50V X7R ceramic capacitors (1206) Murata GRM31CR71H225K
D1	2A, 40V Schottky diode (M-flat) Toshiba CMS11

DESIGNATION	DESCRIPTION
L1	10µH, 1.2A power inductor Sumida CR6D09HPNP-100MC TDK VLP6810T-100M1R2
White LED	3.2V (typ), 3.5V (max) at 20mA Nichia NSSW008C

Table 2. Component Suppliers

SUPPLIER	PHONE	WEBSITE
Murata Electronics North America, Inc.	770-436-1300	www.murata.com
Nichia Corp.	248-352-6575	www.nichia.com
Sumida Corp.	847-545-6700	www.sumida.com
Toshiba America Electronic Components, Inc.	949-455-2000	www.toshiba.com/taec
Vishay	203-268-6261	www.vishay.com

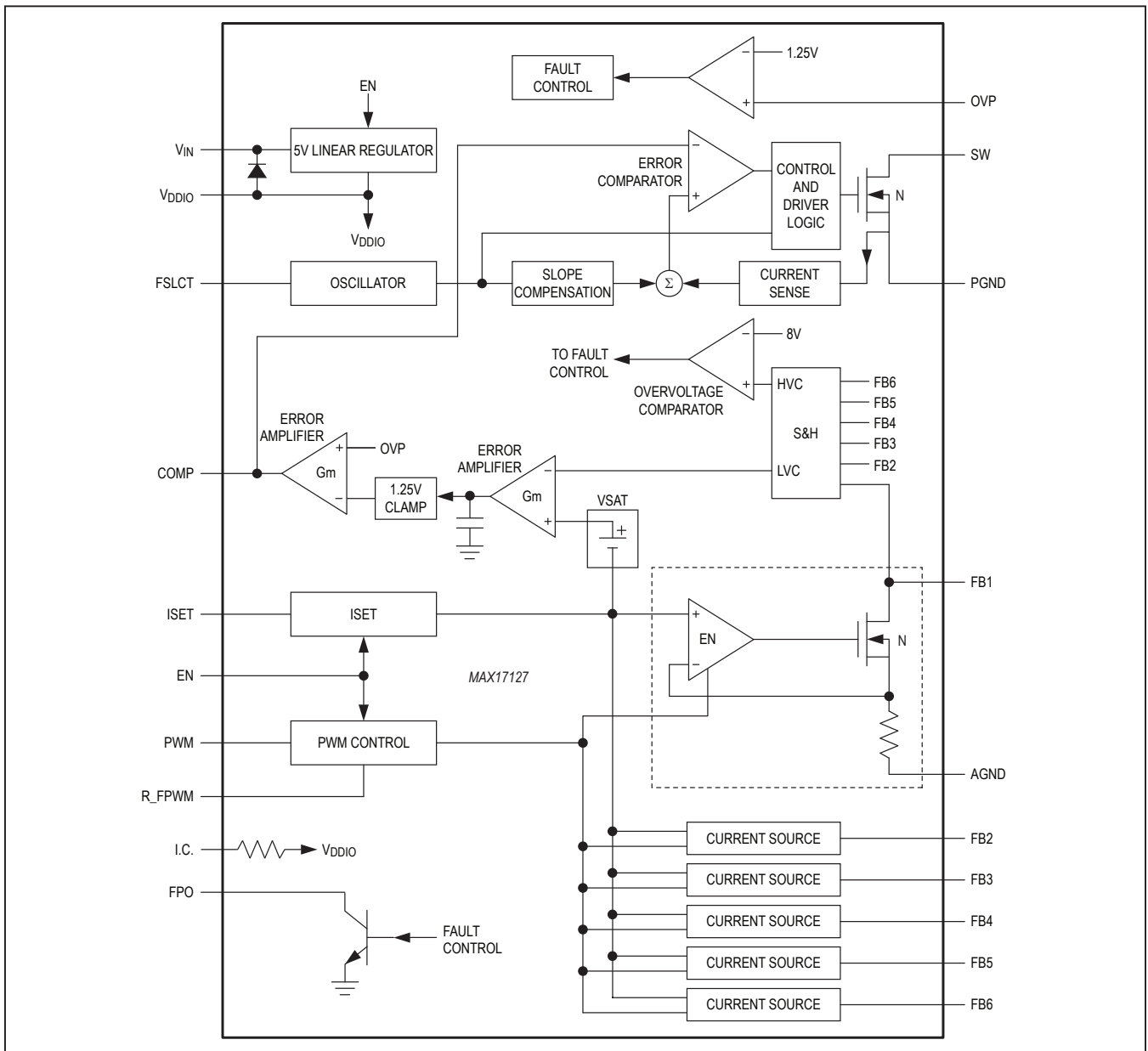

Figure 2. Functional Diagram

Detailed Description

The MAX17127 is a high-efficiency driver for arrays of white LEDs. It contains a fixed-frequency current-mode PWM step-up controller, a 5V linear regulator, a dimming control circuit, an internal power MOSFET, and six regulated current sources. Figure 2 shows the MAX17127 functional diagram. When enabled, the step-up controller boosts the output voltage to provide sufficient headroom for the current sources to regulate their respective string currents. The MAX17127 features resistor-adjustable switching frequency (250kHz to 1MHz), which allows trade-offs between external component size and operating efficiency.

The MAX17127 can implement brightness control through the PWM signal input. The LED current is directly controlled by the external dimming signal's frequency and duty cycle.

The MAX17127 has multiple features to protect the controller from fault conditions. Separate feedback loops limit the output voltage in all circumstances. The MAX17127 checks each FB_ voltage during operation.

If one or more strings are open, the corresponding FB_ voltages are pulled below 180mV (max), and an open-circuit fault is detected. As a result, the respective current sources are disabled.

When one or more LEDs are shorted and the related FB_ voltage exceeds 8V, short fault is detected and the respective current source is disabled if at least one FB_ voltage is lower than the minimum FB_ regulation voltage +460mV (typ).

When in LED open or short conditions, the fault string is disabled while other strings can still operate normally.

The MAX17127 also includes other kinds of fault protections, which are overcurrent, thermal shutdown, and output overvoltage. The MAX17127 features cycle-by-cycle current limit to provide consistent operation and soft-start protection. In an overcurrent condition, the IC latches off if the fault still exists after a 128 μ s overcurrent fault timer expires. The output overvoltage is a nonlatched operation, and the step-up converter stops switching during the fault. A thermal-shutdown circuit provides another level of protection. The MAX17127 is latched off once thermal shutdown occurs.

The MAX17127 includes a 5V linear regulator that provides the internal bias and gate driver for the step-up controller.

Fixed-Frequency Step-Up Controller

The MAX17127's fixed-frequency, current-mode, step-up controller automatically chooses the lowest active FB_ voltage to regulate the feedback voltage. Specifically, the difference between the lowest FB_ voltage and the current source control signal plus an offset is integrated at the COMP output. The resulting error signal is compared to the internal switch current plus slope compensation to determine the switch on-time. As the load changes, the error amplifier sources or sinks current to the COMP output to deliver the required peak inductor current. The slope-compensation signal is added to the current-sense signal in order to improve stability at high duty cycles.

Internal 5V Linear Regulator and UVLO

The MAX17127 includes an internal low-dropout linear regulator (VDDIO). When V_{IN} is higher than 5.0V, this linear regulator generates a 5V supply to power the internal PWM controller, control logic, and MOSFET driver. The VDDIO voltage drops to 3.3V in shutdown. If 5V < V_{IN} < 5.5V, VDDIO and V_{IN} can be connected together and powered from an external 5V supply. There is a body diode from VDDIO to V_{IN}, so V_{IN} must be greater than VDDIO (see Figure 2).

The MAX17127 is disabled until VDDIO exceeds the UVLO threshold. The hysteresis on UVLO is approximately 250mV. In standby mode, the internal LDO is in low-power mode with 10 μ A (max) input current and approximately regulated at 3.3V (typ). When EN = high, the internal LDO is enabled and regulated accurately at 5V (typ).

The VDDIO pin should be bypassed to AGND with a minimum 1 μ F ceramic capacitor.

Startup

At startup, the MAX17127 performs a diagnostic test of the LED array. In the test phase, all FB_ pins are pulled up by a given current source (0.4mA min) during 1ms (typ). If some FB_ voltage is lower than 1.2V (max), the string is considered to be unused. Therefore, when a string is not in use, it should be connected to AGND. All other strings with FB_ higher than 1.2V (max) are detected as in use. After the LED string diagnostic phases are finished, the boost converter starts. An additional 1ms after boost soft-start end is used as minimum FB_ control. The total startup time is less than 10ms, including 2ms (typ) soft-start. Figure 3 shows the sequence.

Shutdown

The MAX17127 can be placed into shutdown by pulling the EN pin low. When a critical failure is detected, the IC also enters shutdown mode. In shutdown mode, all functions of the IC are turned off, including the 5V linear regulator. Only a crude linear regulator remains on, providing a 3.3V (typ) output voltage to V_{DDIO} with 1μA current-sourcing capability.

Frequency Selection

The boost converter switching frequency can be adjusted by the external resistor on the FSLCT pin. The switching-frequency adjustable range is 250kHz to 1MHz. High-frequency (1MHz) operation optimizes the regulator for the smallest component size at the expense of efficiency due to increased switching losses. Low-frequency (250kHz) operation offers the best overall efficiency, but requires larger components and PCB area.

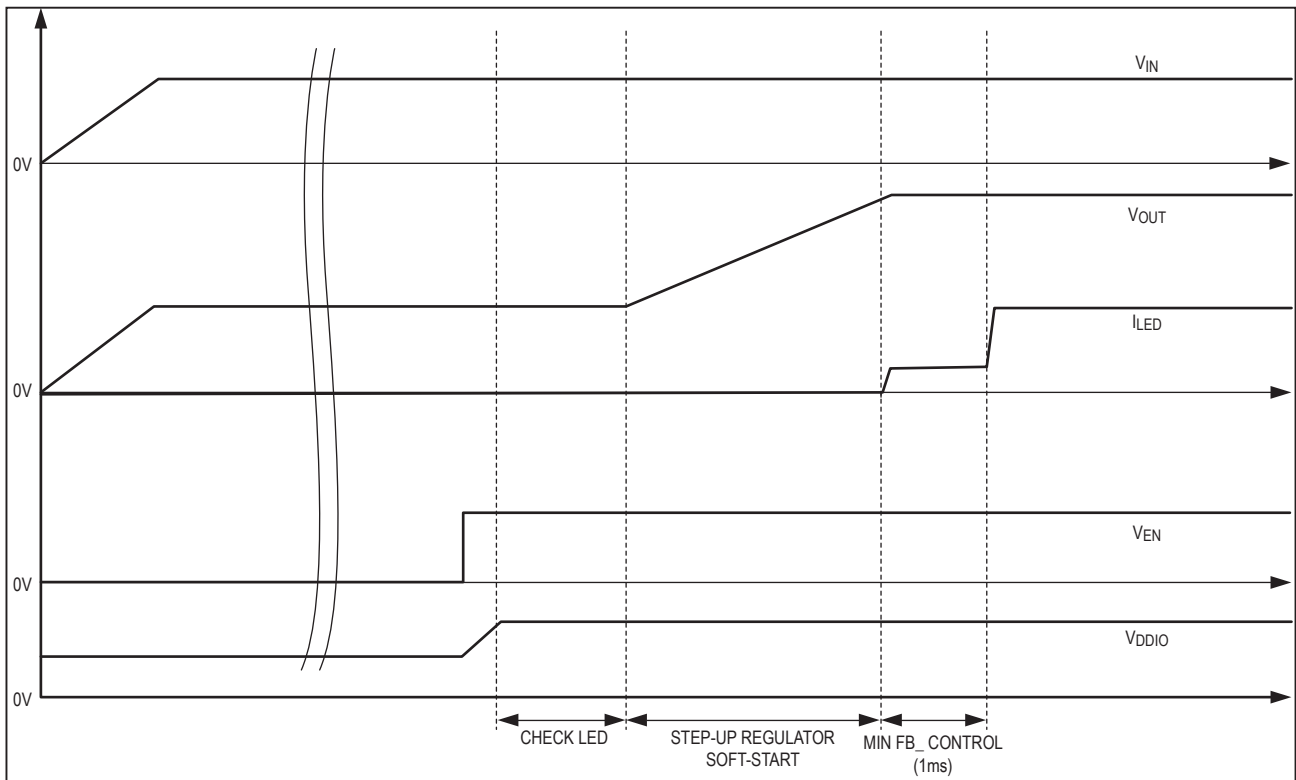

Figure 3. Startup Sequence

Overvoltage Protection

To protect the step-up regulator when the load is open, or if the output voltage becomes excessive for any reason, the MAX17127 features a dedicated overvoltage-feedback input (OVP). The OVP pin is connected to the center tap of a resistive voltage-divider from the high-voltage output. When the OVP pin voltage (V_{OVP}) exceeds 1.25V (typ), a comparator turns off the internal power MOSFET. This step-up regulator switch is reenabled after the V_{OVP} drops 90mV (typ hysteresis) below the protection threshold. This overvoltage-protection feature ensures the step-up regulator fail-safe operation when the LED strings are disconnected from the output.

LED Current Sources

Maintaining uniform LED brightness and dimming capability is critical for backlight applications. The MAX17127 is equipped with a bank of six matched current sources. These specialized current sources are accurate within $\leq 3\%$ and match each other within 2%. They can be switched on and off at PWM frequencies of up to 25kHz. LED full-scale current is set through the ISET pin ($10\text{mA} < I_{LED} < 30\text{mA}$).

The minimum voltage drop across each current source is 480mV (typ) when the LED current is 20mA. The low-voltage drop helps reduce dissipation while maintaining sufficient compliance to control the LED current within the required tolerances.

The LED current sources can be disabled by connecting the respective FB_ pin to AGND at startup. When the IC is enabled, the controller scans settings for all FB_ pins. If an FB_ pin is not connected to AGND, an internal circuit pulls this pin high, and the controller enables the corresponding current source to regulate the string current. If the FB_ pin is connected to AGND, the controller disables the corresponding current regulator. The current regulator cannot be disabled by connecting the respective FB_ pin to AGND after the IC is enabled.

All FB_ pins in use are combined to extract a lowest FB_ voltage (LVC) (see Figure 2). LVC is fed into the step-up regulator's error amplifier and is used to set the output voltage.

Current-Source Fault Protection

LED fault open/short is detected after startup. When one or more strings fail after startup, the corresponding current source is disabled. The remaining LED strings are still operated normally. The LED open/short detection is not executed when LED on-time is less than 2 μ s.

The MAX17127 can tolerate a slight mismatch between LED strings. When severe mismatches or WLED shorts occur, the FB_ voltages are uneven because of mismatched voltage drops across strings. At each LED turn-on, the FB_ voltage is brought down to the regulation voltage quickly. When FB_ voltage is higher than 8V (typ) after LED turn-on, an LED short is detected if at least one FB_ voltage is lower than the minimum FB_ regulation voltage, +460mV (typ). The remaining LED strings can still operate normally. The LED short protection is disabled during the soft-start phase of the step-up regulator.

Open Current-Source Protection

The MAX17127 step-up regulator output voltage is regulated according to the minimum FB_ voltages on all the strings in use. If one or more strings are open, the respective FB_ pins are pulled to ground. For any FB_ lower than 180mV, the corresponding current source is disabled. The remaining LED strings can still operate normally. If all strings in use are open, the MAX17127 shuts the step-up regulator down.

FPO Function

The fault conditions trigger FPO function and pull the FPO pin low. Table 3 shows the state of the FPO pin with different fault conditions.

Dimming Control

The MAX17127 performs brightness control with a PWM input signal. Dimming duty cycle and frequency of current sources follow the signal at the PWM pin directly.

Table 3. FPO Function Table

	FAULT CONDITION		
	THERMAL FAULT	OUTPUT OVERVOLTAGE	INPUT OVERCURRENT
LATCHED	Yes	No (stop switching)	Yes (after time expires)
FPO PIN STATE	Low	Low	Low

Full-Scale and Low-Level LED Current

The full-scale LED current is set by:

$$I_{LED_MAX} = \frac{20mA \times 180k\Omega}{R_{ISET}}$$

The acceptable resistance range for ISET is $120k\Omega < R_{ISET} < 360k\Omega$, which corresponds to full-scale LED current of $30mA > I_{LED_MAX} > 10mA$.

Thermal Shutdown

The MAX17127 includes a thermal-protection circuit. When the local IC temperature exceeds $+150^{\circ}C$ (typ), the controller and current sources shut down. When the thermal shutdown happens, the FPO output pin is asserted low. The controller and current sources do not restart until the next enable signal is sent or input supply is recycled.

Design Procedure

All MAX17127 designs should be prototyped and tested prior to production.

External component-value choice is primarily dictated by the output voltage and the maximum load current, as well as maximum and minimum input voltages. Begin by selecting an inductor value. Once the inductor is known, choose the diode and capacitors.

Step-Up Converter Current Calculation

To ensure stable operation, the MAX17127 includes slope compensation, which sets the minimum inductor value. In continuous-conduction mode (CCM), the minimum inductor value is calculated with the following equation:

$$L_{CCM(MIN)} = \frac{(V_{OUT(MAX)} + V_{DIODE} - 2 \times V_{IN(MIN)}) \times R_S}{2 \times SF \times f_{SW(MIN)}}$$

where:

$$SF = \begin{cases} 72mV, & \text{when } V_{IN} < 12.5V \\ \frac{72mV}{1 + \frac{V_{IN} - 12.5V}{10.6V}}, & \text{when } V_{IN} > 12.5V \end{cases}$$

SF is a scale factor from the slope compensation depending on input voltage (this allows a higher current capability), the $L_{CCM(MIN)}$ is the minimum inductor value for stable operation in CCM, and $R_S = 15m\Omega$ (typ) is the equivalent sensing scale factor from the controller's internal current-sense circuit.

The controller can also operate in discontinuous-conduction mode (DCM). In this mode, the inductor value can be lower, but the peak inductor current is higher than in CCM. In DCM, the maximum inductor value is calculated with the following equation:

$$L_{DCM(MAX)} = \left(1 - \frac{V_{IN(MIN)}}{V_{OUT(MAX)} + V_{DIODE}} \right) \times \frac{V_{IN(MIN)}^2 \times \eta}{2 \times f_{SW(MAX)} \times V_{OUT(MAX)} \times I_{OUT(MAX)}}$$

where the $L_{DCM(MAX)}$ is the maximum inductor value for DCM, η is the nominal regulator efficiency (85%), and $I_{OUT(MAX)}$ is the maximum output current.

The output current capability of the step-up regulator is a function of current limit, input voltage, operating frequency, and inductor value. Because the slope compensation is used to stabilize the feedback loop, the inductor current limit depends on the duty cycle, and is determined with the following equation:

$$I_{LIM} = \begin{cases} \frac{SF}{R_S} \times 0.97, & \text{when } D < 30\% \\ \frac{SF}{R_S} \times (1.27 - D), & \text{when } D > 30\% \end{cases}$$

where SF is the scale factor from the slope compensation, 2.5A is the current limit specified at 75% duty cycle, and D is the duty cycle.

The output current capability depends on the current-limit value and operating mode. The maximum output current in CCM is governed by the following equation:

$$I_{OUT_CCM(MAX)} = \left(I_{LIM} - \frac{0.5 \times D \times V_{IN}}{f_{SW} \times L} \right) \times \frac{V_{IN}}{V_{OUT}} \times \eta$$

where I_{LIM} is the current limit calculated above, η is the nominal regulator efficiency (85%), and D is the duty cycle. The corresponding duty cycle for this current is:

$$D = \frac{V_{OUT} - V_{IN} + V_{DIODE}}{V_{OUT} - I_{LIM} \times R_{ON} + V_{DIODE}}$$

where V_{DIODE} is the forward voltage of the rectifier diode and R_{ON} is the internal MOSFET's on-resistance (0.2 Ω typ).

The maximum output current in DCM is governed by the following equation:

$$I_{OUT_DCM(MAX)} = \frac{L \times I_{LIM}^2 \times f_{SW} \times \eta \times (V_{OUT} + V_{DIODE})}{2 \times V_{OUT} \times (V_{OUT} + V_{DIODE} - V_{IN})}$$

Inductor Selection

The inductance, peak current rating, series resistance, and physical size should all be considered when selecting an inductor. These factors affect the converter's operating mode, efficiency, maximum output load capability, transient response time, output voltage ripple, and cost. The maximum output current, input voltage, output voltage, and switching frequency determine the inductor value. Very high inductance minimizes the current ripple, and therefore reduces the peak current, which decreases core losses in the inductor and I^2R losses in the entire power path. However, large inductor values also require more energy storage and more turns of wire, which increase physical size and I^2R copper losses. Low inductor values decrease the physical size but increase the current ripple and peak current. Finding the best inductor involves compromises among circuit efficiency, inductor size, and cost.

In choosing an inductor, the first step is to determine the operating mode: continuous-conduction mode (CCM) or discontinuous-conduction mode (DCM). The MAX17127 has a fixed internal-slope compensation, which requires a minimum inductor value. When CCM is chosen, the ripple current and the peak current of the inductor can be minimized. If a small-size inductor is required, DCM can be chosen. In DCM, the inductor value and size can be minimized, but the inductor ripple current and peak current are higher than those in CCM. The controller can be stable, independent of the internal slope-compensation mode, but there is a maximum inductor-value requirement to ensure the DCM operating mode.

The equations used here include a constant LIR, which is the ratio of the inductor peak-to-peak ripple current to the average DC inductor current at the full-load current. The controller operates in DCM mode when LIR is higher than 2.0, and it works in CCM mode when LIR is lower than 2.0. The best trade-off between inductor size and converter efficiency for step-up regulators generally has an LIR between 0.3 and 0.5. However, depending on the AC characteristics of the inductor core material and ratio

of inductor resistance to other power-path resistances, the best LIR can shift up or down. If the inductor resistance is relatively high, more ripples can be accepted to reduce the number of required turns and increase the wire diameter. If the inductor resistance is relatively low, increasing inductance to lower the peak current can reduce losses throughout the power path. If extremely thin high-resistance inductors are used, as is common for LCD panel applications, LIR higher than 2.0 can be chosen for DCM operating mode.

Once a physical inductor is chosen, higher and lower values of the inductor should be evaluated for efficiency improvements in typical operating regions. The detailed design procedure for CCM can be described as follows:

Calculate the approximate inductor value using the typical input voltage (V_{IN}), the maximum output current ($I_{OUT(MAX)}$), the expected efficiency (η_{TYP}) taken from an appropriate curve in the *Typical Operating Characteristics*, and an estimate of LIR based on the above discussion:

$$L = \left(\frac{V_{IN(MIN)}}{V_{OUT}} \right)^2 \left(\frac{V_{OUT} - V_{IN(MIN)}}{I_{OUT(MAX)} \times f_{SW}} \right) \left(\frac{\eta_{TYP}}{LIR} \right)$$

The MAX17127 has a minimum inductor-value limitation for stable operation in CCM operating mode at low input voltage because of the internal fixed-slope compensation. The minimum inductor value for stability is calculated with the following equation:

$$L_{CCM(MIN)} = \frac{(V_{OUT(MAX)} + V_{DIODE} - 2 \times V_{IN(MIN)}) \times R_S}{2 \times SF \times f_{SW(MIN)}}$$

where SF is a scale factor from slope compensation, and R_S is the equivalent current-sensing scale factor (15m Ω typ).

Choose an available inductor value from an appropriate inductor family. Calculate the maximum DC input current at the minimum input voltage $V_{IN(MIN)}$, using conservation of energy and the expected efficiency at that operating point (η_{MIN}) taken from an appropriate curve in the *Typical Operating Characteristics*:

$$I_{IN(DC,MAX)} = \frac{I_{OUT(MAX)} \times V_{OUT}}{V_{IN(MIN)} \times \eta_{MIN}}$$

Calculate the ripple current at that operating point and the peak current required for the inductor:

$$I_{\text{RIPPLE}} = \frac{V_{\text{IN(MIN)}} \times (V_{\text{OUT(MAX)}} - V_{\text{IN(MIN)}})}{L \times V_{\text{OUT(MAX)}} \times f_{\text{SW}}}$$

$$I_{\text{PEAK}} = I_{\text{IN(DC,MAX)}} + \frac{I_{\text{RIPPLE}}}{2}$$

When DCM operating mode is chosen to minimize the inductor value, the calculations are different from those above in CCM operating mode. The maximum inductor value for DCM mode is calculated with the following equation:

$$L_{\text{DCM(MAX)}} = \left(1 - \frac{V_{\text{IN(MIN)}}}{V_{\text{OUT(MAX)}} + V_{\text{DIODE}}} \right) \times \frac{V_{\text{IN(MIN)}}^2 \times \eta}{2 \times f_{\text{SW(MAX)}} \times V_{\text{OUT(MAX)}} \times I_{\text{OUT(MAX)}}$$

The peak inductor current in DCM is calculated with the following equation:

$$I_{\text{PEAK}} = \sqrt{\frac{I_{\text{OUT(MAX)}} \times 2 \times V_{\text{OUT(MAX)}} \times (V_{\text{OUT(MAX)}} + V_{\text{DIODE}} - V_{\text{IN(MIN)}})}{L \times f_{\text{SW(MIN)}} \times \eta \times (V_{\text{OUT(MAX)}} + V_{\text{DIODE}})}}$$

The inductor's saturation current rating should exceed I_{PEAK} , and the inductor's DC current rating should exceed $I_{\text{IN(DC,MAX)}}$. For good efficiency, choose an inductor with less than 0.1Ω series resistance.

Considering the circuit with six 10-LED strings and 20mA LED full-scale current, the maximum load current ($I_{\text{OUT(MAX)}}$) is 120mA with a 32V output and a minimal input voltage of 7V.

Choosing a CCM operating mode with LIR = 0.7 at 1MHz and estimating efficiency of 85% at this operating point:

$$L = \left(\frac{7\text{V}}{32\text{V}} \right)^2 \left(\frac{32\text{V} - 7\text{V}}{120\text{mA} \times 1\text{MHz}} \right) \left(\frac{0.85}{0.7} \right) = 12.1\mu\text{H}$$

In CCM, the inductor has to be higher than $L_{\text{CCM(MIN)}}$:

$$L_{\text{CCM(MIN)}} = \frac{(32\text{V} + 0.4\text{V} - 2 \times 7\text{V}) \times 13.7\text{m}\Omega}{2 \times 25.5\text{mV} \times 0.9\text{MHz}} = 5.5\mu\text{H}$$

A $10\mu\text{H}$ inductor is chosen, which is higher than the minimum L that guarantees stability in CCM.

The peak inductor current at minimum input voltage is calculated as follows:

$$I_{\text{PEAK}} = \frac{120\text{mA} \times 32\text{V}}{7\text{V} \times 0.85} + \frac{7\text{V} \times (32\text{V} - 7\text{V})}{2 \times 10\mu\text{H} \times 32\text{V} \times 0.9\text{MHz}} = 0.95\text{A}$$

Alternatively, choose a DCM operating mode by using lower inductance and estimating efficiency of 85% at this operating point. Since DCM has higher peak inductor current at lower input, it causes current limit when the parameters are not chosen properly. Considering the case with six 10-LED strings and 20mA LED full-scale current to prevent excessive switch current from causing current limit:

$$L_{\text{DCM(MAX)}} = \left(1 - \frac{7\text{V}}{32\text{V} + 0.4\text{V}} \right) \times \frac{(7\text{V})^2 \times 0.85}{2 \times 1.1\text{MHz} \times 32\text{V} \times 120\text{mA}} = 3.9\mu\text{H}$$

A $3.3\mu\text{H}$ inductor is chosen. The peak inductor current at minimum input voltage is calculated as follows:

$$I_{\text{PEAK}} = \sqrt{\frac{120\text{mA} \times 2 \times 32\text{V} \times (32\text{V} + 0.4\text{V} - 7\text{V})}{3.3\mu\text{H} \times 1.1\text{MHz} \times 0.85 \times (32\text{V} + 0.4\text{V})}} = 1.40\text{A}$$

Output Capacitor Selection

The total output-voltage ripple has two components: the capacitive ripple caused by the charging and discharging on the output capacitor, and the ohmic ripple due to the capacitor's equivalent series resistance (ESR):

$$V_{\text{RIPPLE}} = V_{\text{RIPPLE(C)}} + V_{\text{RIPPLE(ESR)}}$$

$$V_{\text{RIPPLE(C)}} \approx \frac{I_{\text{OUT(MAX)}}}{C_{\text{OUT}}} \left(\frac{V_{\text{OUT(MAX)}} - V_{\text{IN(MIN)}}}{V_{\text{OUT(MAX)}} \times f_{\text{SW}}} \right)$$

and:

$$V_{\text{RIPPLE(ESR)}} \approx I_{\text{PEAK}} R_{\text{ESR(COUT)}}$$

where I_{PEAK} is the peak inductor current (see the *Inductor Selection* section).

The output-voltage ripple should be low enough for the FB_ current-source regulation. The ripple voltage should be less than $200\text{mV}_{\text{P-P}}$. For ceramic capacitors, the output-voltage ripple is typically dominated by $V_{\text{RIPPLE(C)}}$.

The voltage rating and temperature characteristics of the output capacitor must also be considered.

Rectifier Diode Selection

The MAX17127's high switching frequency demands a high-speed rectifier. Schottky diodes are recommended for most applications because of their fast recovery time and low forward voltage. The diode should be rated to handle the output voltage and the peak switch current. Make sure that the diode's peak current rating is at least I_{PEAK} calculated in the *Inductor Selection* section and that its breakdown voltage exceeds the output voltage.

Overvoltage-Protection Determination

The overvoltage-protection circuit ensures the circuit safe operation; therefore, the controller should limit the output voltage within the ratings of all MOSFET, diode, and output capacitor components, while providing sufficient output voltage for LED current regulation. The OVP pin is connected to the center tap of a resistive voltage-divider (R1 and R2 in Figure 1) from the high-voltage output. When the controller detects the OVP pin voltage reaching the threshold V_{OVP_TH} , typically 1.25V, overvoltage protection is activated. Hence, the step-up converter output overvoltage-protection point is:

$$V_{OUT(OVP)} = V_{OVP_TH} \times \left(1 + \frac{R1}{R2}\right)$$

$V_{OUT(OVP)}$ depends on how many LEDs are used for each string and $V_{OUT(OVP)} = 1.25V \times V_{OUT}$, generally and where V_{OUT} is the LED's operating voltage for each string.

In Figure 1, the output OVP voltage is set to:

$$V_{OUT(OVP)} = 1.25V \times \left(1 + \frac{2.21M\Omega}{71.5k\Omega}\right) = 39.71V$$

Input Capacitor Selection

The input capacitor (C_{IN}) filters the current peaks drawn from the input supply and reduces noise injection into the IC. A 4.7 μ F ceramic capacitor is used in the typical operating circuit (Figure 1) because of the high source impedance seen in typical lab setups. Actual applications usually have much lower source impedance since the step-up regulator often runs directly from the output of another regulated supply. In some applications, C_{IN} can be reduced below the values used in the typical operating circuit. Ensure a low-noise supply at IN by using adequate C_{IN} . Alternatively, greater voltage variation can be tolerated on C_{IN} if IN is decoupled from C_{IN} using an RC lowpass filter.

LED Selection and Bias

The series/parallel configuration of the LED load and the full-scale bias current have a significant effect on regulator performance. LED characteristics vary significantly from manufacturer to manufacturer. Consult the respective LED data sheets to determine the range of output voltages for a given brightness and LED current. In general, brightness increases as a function of bias current. This suggests that the number of LEDs could be decreased if higher bias current is chosen; however, high current increases LED temperature and reduces operating life. Improvements in LED technology are resulting in devices with lower forward voltage while increasing the bias current and light output.

LED manufacturers specify LED color at a given LED current. With lower LED current, the color of the emitted light tends to shift toward the blue range of the spectrum. A blue bias is often acceptable for business applications, but not for high-image-quality applications such as DVD players. Direct-DPWM dimming is a viable solution for reducing power dissipation while maintaining LED color integrity. Careful attention should be paid to switching noise to avoid other display-quality problems.

Using fewer LEDs in a string improves step-up converter efficiency, and lowers breakdown voltage requirements of the external MOSFET and diode. The minimum number of LEDs in series should always be greater than maximum input voltage. If the diode voltage drop is lower than maximum input voltage, the voltage drop across the current-sense inputs (FB_) increases and causes excess heating in the IC. Between 8 and 12 LEDs in series are ideal for input voltages up to 20V.

Applications Information

LED V_{FB} Variation

The forward voltage of each white LED may vary up to 25% from part to part and the accumulated voltage difference in each string equates to additional power loss within the IC. For the best efficiency, the voltage difference between strings should be minimized. The difference between lowest voltage string and highest voltage string should be less than 8V (typ). Otherwise, the internal LED short-protection circuit disables the high V_{FB} voltage string.

FB Pin Maximum Voltage

The current through each FB_ pin is controlled only during the step-up converter's on-time. During the converter off-time, the current sources are turned off. The output voltage does not discharge and stays high. The MAX17127 disables the FB_ current source, which the string is shorted. In this case, the step-up converter's output voltage is always applied to the disabled FB_ pin. The FB_ pin can withstand 45V.

PCB Layout Guidelines

Careful PCB layout is important for proper operation. Use the following guidelines for good PCB layout:

- 1) Minimize the area of high-current switching loop of rectifier diode, internal MOSFET, and output capacitor to avoid excessive switching noise.
- 2) Connect high-current input and output components with short and wide connections. The high-current input loop goes from the positive terminal of the input capacitor to the inductor, to the internal MOSFET, and then to the input capacitor's negative terminal. The high-current output loop is from the positive terminal of the input capacitor to the inductor, to the rectifier diode, and to the positive terminal of the output capacitors, reconnecting between the output capacitor and input capacitor ground terminals. Avoid using vias in the high-current paths. If vias are unavoidable, use multiple vias in parallel to reduce resistance and inductance.
- 3) Create a ground island (PGND) consisting of the input and output capacitor ground. Connect all these together with short, wide traces or a small ground plane. Maximizing the width of the power ground traces improves efficiency and reduces output-voltage ripple and noise spikes. Create an analog ground island (AGND) consisting of the overvoltage-detection divider (R1 and R2) ground connection; the ISET, FSLCT, COMP resistor connections; and the device's exposed backside pad. Connect the AGND and PGND islands by connecting the AGND pins directly to the exposed backside pad. Make no other connections between these separate ground planes.
- 4) Place the overvoltage-detection divider resistors as close as possible to the OVP pin. The divider's center trace should be kept short. Placing the resistors far away causes the sensing trace to become antennae that can pick up switching noise. Avoid running the sensing traces near SW.
- 5) Place the V_{IN} pin and V_{DDIO} pin bypass capacitors as close to the device as possible. The ground connection of the bypass capacitors should be connected directly to AGND pins with a wide trace.
- 6) Minimize the size of the SW node while keeping it wide and short. Keep the SW node away from the feedback node and ground. If possible, avoid running the SW node from one side of the PCB to the other. Use DC traces as a shield if necessary.

Refer to the MAX17127 Evaluation Kit data sheet for an example of proper board layout.

Simplified Operating Circuit (Direct-PWM Mode)

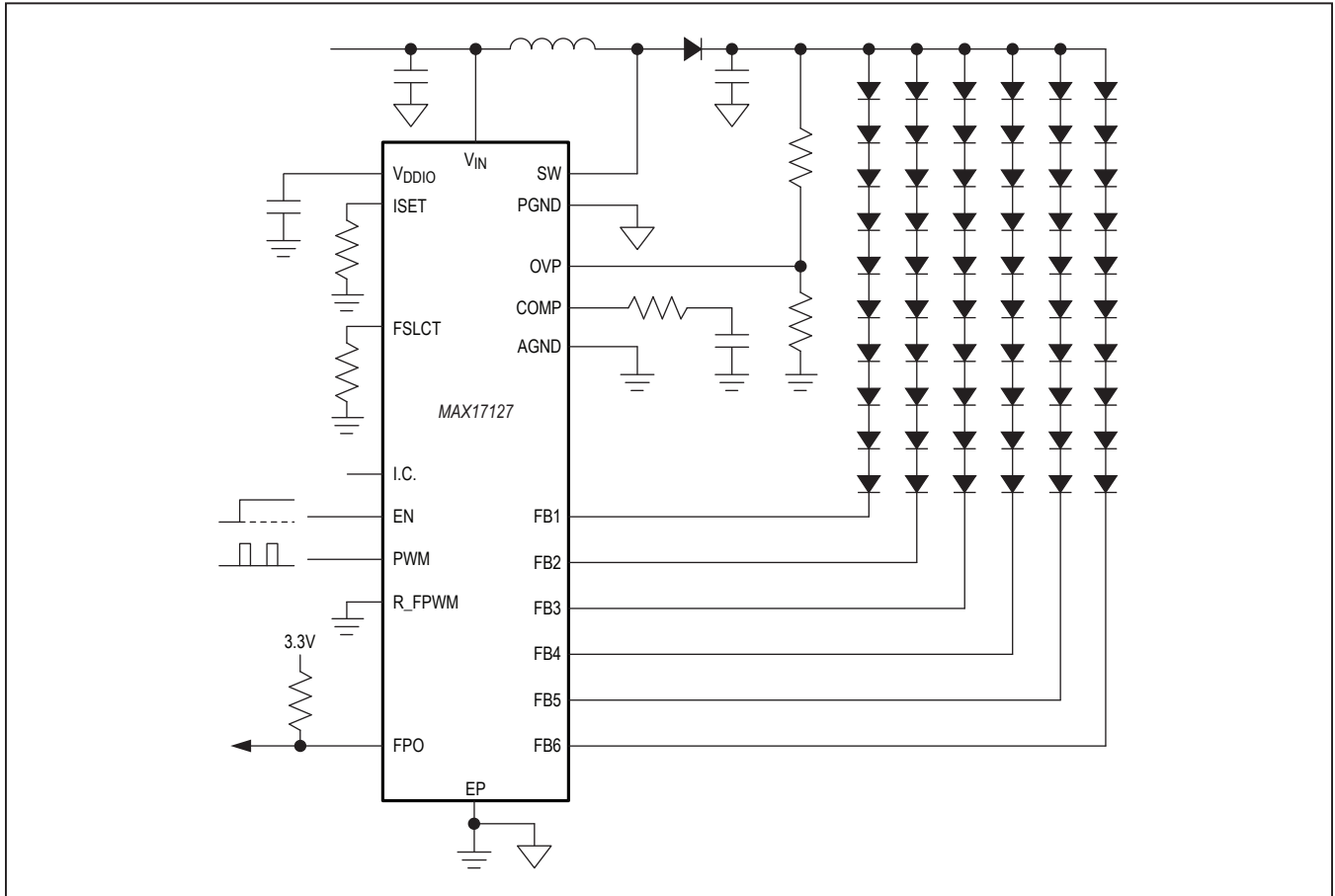

Chip Information

PROCESS: BiCMOS

Package Information

For the latest package outline information and land patterns (footprints), go to www.maximintegrated.com/packages. Note that a "+", "#", or "-" in the package code indicates RoHS status only. Package drawings may show a different suffix character, but the drawing pertains to the package regardless of RoHS status.

PACKAGE TYPE	PACKAGE CODE	DOCUMENT NO.
20 TQFN	T2044+3	21-0139

Revision History

REVISION NUMBER	REVISION DATE	DESCRIPTION	PAGES CHANGED
0	3/10	Initial release	—
1	11/14	No <i>IV</i> OPN in <i>Ordering Information</i> ; deleted automotive reference from <i>Applications</i> section	1

For pricing, delivery, and ordering information, please contact Maxim Direct at 1-888-629-4642, or visit Maxim Integrated's website at www.maximintegrated.com.

Maxim Integrated cannot assume responsibility for use of any circuitry other than circuitry entirely embodied in a Maxim Integrated product. No circuit patent licenses are implied. Maxim Integrated reserves the right to change the circuitry and specifications without notice at any time. The parametric values (min and max limits) shown in the Electrical Characteristics table are guaranteed. Other parametric values quoted in this data sheet are provided for guidance.