

December 1996

Fast CMOS 3.3V 8-Bit Transparent Latch

Features

- Advanced 0.6 micron CMOS Technology
- Compatible with LCX™ Families of Products
- Supports 5V Tolerant Mixed Signal Mode Operation
 - Input Can Be 3V or 5V
 - Output Can Be 3V or Connected to 5V Bus
- Advanced Low Power CMOS Operation
- Excellent Output Drive Capability:
 - Balanced Drives (24mA Sink and Source)
- Low Ground Bounce Outputs
- Hysteresis on All Inputs

Ordering Information

PART NUMBER	TEMP. RANGE (°C)	PACKAGE	PKG. NO.
CD74LPT373AM	-40 to 85	20 Ld SOIC	M20.3-P
CD74LPT373AQM	-40 to 85	20 Ld QSOP	M20.15-P
CD74LPT373CM	-40 to 85	20 Ld SOIC	M20.3-P
CD74LPT373CQM	-40 to 85	20 Ld QSOP	M20.15-P
CD74LPT373M	-40 to 85	20 Ld SOIC	M20.3-P
CD74LPT373QM	-40 to 85	20 Ld QSOP	M20.15-P

NOTE: QSOP is commonly known as SSOP.

When ordering, use the entire part number. Add the suffix 96 to obtain the variant in the tape and reel.

Description

The CD74LPT373 is an 8-bit transparent latch designed with three-state outputs and is intended for bus oriented applications. When Latch Enable (LE) is HIGH, the flip-flops appear transparent to the data. The data that meets the set-up time when LE is LOW is latched. When \overline{OE} is HIGH, the bus output is in the high impedance state.

The CD74LPT373 can be driven from either 3.3V or 5.0V devices allowing this device to be used as a translator in a mixed 3.3/5.0V system.

Pinout

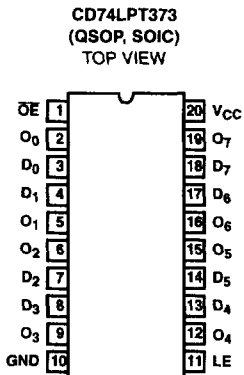

3

3.3V LPT

CD74LPT373

Functional Block Diagram

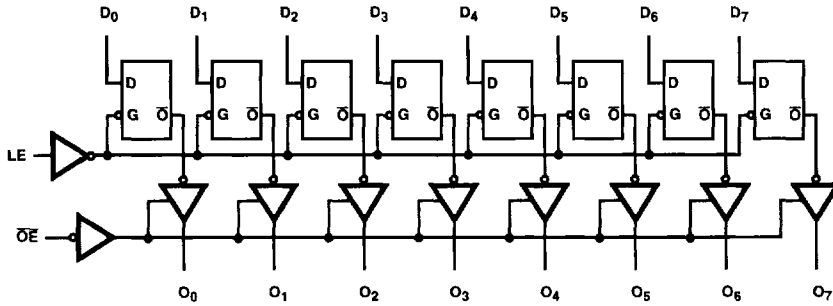

TRUTH TABLE (NOTE 1)

INPUTS			OUTPUTS
D_N	LE	\overline{OE}	O_N
H	H	L	H
L	H	L	L
X	X	H	Z

NOTE:

1. H = High Voltage Level
L = Low Voltage Level
X = Don't Care
Z = High Impedance

Pin Descriptions

PIN NAME	DESCRIPTION
\overline{OE}	Output Enable Input (Active LOW)
LE	Latch Enable Input (Active HIGH)
D_7 - D_0	Data Inputs
O_7 - O_0	Three-State Outputs
GND	Ground
V_{CC}	Power

CD74LPT373

Absolute Maximum Ratings

DC Input Voltage	-0.5V to 7.0V
DC Output Current	120mA

Operating Conditions

Operating Temperature Range	-40°C to 85°C
Supply Voltage to Ground Potential	
Inputs and V _{CC} Only	-0.5V to 7.0V
Supply Voltage to Ground Potential	
Outputs and D/O Only	-0.5V to 7.0V

Thermal Information

Thermal Resistance (Typical, Note 2)	θ_{JA} (°C/W)
SOIC Package	87
QSOP Package	110
Maximum Junction Temperature	150°C
Maximum Storage Temperature Range	-65°C to 150°C
Maximum Lead Temperature (Soldering 10s)	300°C
	(Lead Tips Only)

CAUTION: Stresses above those listed in "Absolute Maximum Ratings" may cause permanent damage to the device. This is a stress only rating and operation of the device at these or any other conditions above those indicated in the operational sections of this specification is not implied.

NOTE:

2. θ_{JA} is measured with the component mounted on an evaluation PC board in free air.

Electrical Specifications

PARAMETER	SYMBOL	(NOTE 3) TEST CONDITIONS	MIN	(NOTE 4) TYP	MAX	UNITS
DC ELECTRICAL SPECIFICATIONS Over the Operating Range, $T_A = -40^\circ\text{C}$ to 85°C , $V_{CC} = 2.7\text{V}$ to 3.6V						
Input HIGH Voltage (Input Pins)	V_{IH}	Guaranteed Logic HIGH Level	2.2	-	5.5	V
Input HIGH Voltage (I/O Pins)	V_{IH}	Guaranteed Logic HIGH Level	2.0	-	5.5	V
Input LOW Voltage (Input and I/O Pins)	V_{IL}	Guaranteed Logic LOW Level	-0.5	-	0.8	V
Input HIGH Current (Input Pins)	I_{IH}	$V_{CC} = \text{Max}$ $V_{IN} = 5.5\text{V}$	-	-	± 1	μA
Input HIGH Current (I/O Pins)	I_{IH}	$V_{CC} = \text{Max}$ $V_{IN} = V_{CC}$	-	-	± 1	μA
Input LOW Current (Input Pins)	I_{IL}	$V_{CC} = \text{Max}$ $V_{IN} = \text{GND}$	-	-	± 1	μA
Input LOW Current (I/O Pins)	I_{IL}	$V_{CC} = \text{Max}$ $V_{IN} = \text{GND}$	-	-	± 1	μA
High Impedance Output Current (Three-State)	I_{OZH} I_{OZL}	$V_{CC} = \text{Max}$ $V_{OUT} = 5.5\text{V}$	-	-	± 1	μA
		$V_{CC} = \text{Max}$ $V_{OUT} = \text{GND}$	-	-	± 1	μA
Clamp Diode Voltage	V_{IK}	$V_{CC} = \text{Min}$, $I_{IN} = -18\text{mA}$	-	-0.7	-1.2	V
Output HIGH Current	I_{ODH}	$V_{CC} = 3.3\text{V}$, $V_{IN} = V_{IH}$ or V_{IL} , $V_O = 1.5\text{V}$ (Note 5)	-36	-60	-110	mA
Output LOW Current	I_{ODL}	$V_{CC} = 3.3\text{V}$, $V_{IN} = V_{IH}$ or V_{IL} , $V_O = 1.5\text{V}$ (Note 5)	50	90	200	mA
Output HIGH Voltage	V_{OH}	$V_{CC} = \text{Min}$, $V_{IN} = V_{IH}$ or V_{IL}	$I_{OH} = -0.1\text{mA}$	$V_{CC} - 0.2$	-	V
			$I_{OH} = -3\text{mA}$	2.4	3.0	V
		$V_{CC} = 3.0\text{V}$, $V_{IN} = V_{IH}$ or V_{IL}	$I_{OH} = -8\text{mA}$	2.4 (Note 7)	3.0	V
			$I_{OH} = -24\text{mA}$	2.0	-	V
Output LOW Voltage	V_{OL}	$V_{CC} = \text{Min}$, $V_{IN} = V_{IH}$ or V_{IL}	$I_{OL} = 0.1\text{mA}$	-	0.2	V
			$I_{OL} = 16\text{mA}$	-	0.2	V
			$I_{OL} = 24\text{mA}$	-	0.3	V

3

3.3V LPT

CD74LPT373

Electrical Specifications (Continued)

PARAMETER	SYMBOL	(NOTE 3) TEST CONDITIONS	MIN	(NOTE 4) TYP	MAX	UNITS	
Short Circuit Current (Note 6)	I_{OS}	$V_{CC} = \text{Max (Note 5), } V_{OUT} = \text{GND}$	-60	-85	-240	mA	
Power Down Disable	I_{OFF}	$V_{CC} = 0V, V_{IN} \text{ or } V_{OUT} \leq 4.5V$	-	-	± 100	μA	
Input Hysteresis	V_H		-	150	-	mV	
CAPACITANCE $T_A = 25^\circ C, f = 1\text{MHz}$							
Input Capacitance (Note 8)	C_{IN}	$V_{IN} = 0V$	-	4.5	6	pF	
Output Capacitance (Note 8)	C_{OUT}	$V_{OUT} = 0V$	-	5.5	8	pF	
POWER SUPPLY SPECIFICATIONS							
Quiescent Power Supply Current	I_{CC}	$V_{CC} = \text{Max}$	$V_{IN} = \text{GND}$ or V_{CC}	-	0.1	10	μA
Quiescent Power Supply Current TTL Inputs HIGH	ΔI_{CC}	$V_{CC} = \text{Max}$	$V_{IN} = V_{CC} - 0.6V$ (Note 9)	-	2.0	30	μA
Dynamic Power Supply (Note 10)	I_{CCD}	$V_{CC} = \text{Max, Outputs Open}$ $\overline{OE} = \text{GND}$ One Bit Toggling 50% Duty Cycle	$V_{IN} = V_{CC}$ $V_{IN} = \text{GND}$	-	50	75	$\mu A/\text{MHz}$
Total Power Supply Current (Note 12)	I_C	$V_{CC} = \text{Max, Outputs Open}$ $f_1 = 10\text{MHz, 50% Duty Cycle}$ $\overline{OE} = \text{GND}$ One Bit Toggling	$V_{IN} = V_{CC} - 0.6V$ $V_{IN} = \text{GND}$	-	0.6	2.3	mA
		$V_{CC} = \text{Max, Outputs Open}$ $f_1 = 2.5\text{MHz, 50% Duty Cycle}$ $\overline{OE} = \text{GND}$ 8 Bits Toggling	$V_{IN} = V_{CC} - 0.6V$ $V_{IN} = \text{GND}$	-	2.1	4.7 (Note 11)	mA

CD74LPT373

Switching Specifications Over Operating Range (Note 13)

PARAMETER	SYMBOL	(NOTE 14) TEST CONDITIONS	CD74LPT373		CD74LPT373A		CD74LPT373C		UNITS
			(NOTE 15) MIN	MAX	(NOTE 15) MIN	MAX	(NOTE 15) MIN	MAX	
Propagation Delay D _X to O _X	t _{PLH} , t _{PHL}	C _L = 50pF R _L = 500Ω	1.5	8.0	1.5	5.2	1.5	4.2	ns
Propagation Delay LE to O _X	t _{PLH} , t _{PHL}		2.0	8.5	2.0	8.5	2.0	5.5	ns
Output Enable Time OE to O _X	t _{PZH} , t _{PZL}		1.5	8.5	1.5	6.5	1.5	5.5	ns
Output Disable Time (Note 16) OE to O _X	t _{PHZ} , t _{PLZ}		1.5	7.5	1.5	5.5	1.5	5.0	ns
Setup Time HIGH or LOW, D _X to LE	t _{SU}		2.0	-	2.0	-	2.0	-	ns
Hold Time HIGH or LOW, D _X to LE	t _H		1.5	-	1.5	-	1.5	-	ns
LE Pulse Width (Note 16) HIGH	t _W		6.0	-	5.0	-	5.0	-	ns
Output Skew (Note 17)	t _{SK(O)}		-	0.5	-	0.5	-	0.5	ns

NOTES:

3. For conditions shown as Max or Min, use appropriate value specified under Electrical Specifications for the applicable device type.
4. Typical values are at V_{CC} = 3.3V, 25°C ambient and maximum loading.
5. Not more than one output should be shorted at one time. Duration of the test should not exceed one second.
6. This parameter is guaranteed but not tested.
7. V_{OH} = V_{CC} - 0.6V at rated current.
8. This parameter is determined by device characterization but is not production tested.
9. Per TTL driven input; all other inputs at V_{CC} or GND.
10. This parameter is not directly testable, but is derived for use in Total Power Supply Calculations.
11. Values for these conditions are examples of the I_{CC} formula. These limits are guaranteed but not tested.
12. $I_C = I_{\text{QUIESCENT}} + I_{\text{INPUTS}} + I_{\text{DYNAMIC}}$
 $I_C = I_{CC} + \Delta I_{CC} D_H N_T + I_{CCD} (f_{CP}/2 + f_i N_i)$
 I_{CC} = Quiescent Current
 ΔI_{CC} = Power Supply Current for a TTL High Input
 D_H = Duty Cycle for TTL Inputs High
 N_T = Number of TTL Inputs at D_H
 I_{CCD} = Dynamic Current Caused by an Input Transition Pair (HLH or LHL)
 f_{CP} = Clock Frequency for Register Devices (Zero for Non-Register Devices)
 f_i = Input Frequency
 N_i = Number of Inputs at f_i
 All currents are in milliamps and all frequencies are in megahertz.
13. Propagation Delays and Enable/Disable times are with V_{CC} = 3.3V ±0.3V, normal range. For V_{CC} = 2.7V, extended range, all Propagation Delays and Enable/Disable times should be degraded by 20%.
14. See test circuit and wave forms.
15. Minimum limits are guaranteed but not tested on Propagation Delays.
16. This parameter is guaranteed but not production tested.
17. Skew between any two outputs, of the same package, switching in the same direction. This parameter is guaranteed by design.

3

3.3V LPT

Test Circuits and Waveforms

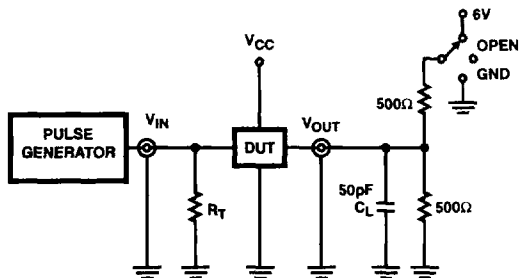

NOTE:

18. Pulse Generator for All Pulses: Rate $\leq 1.0\text{MHz}$; $Z_{OUT} \leq 50\Omega$;
 $t_r, t_f \leq 2.5\text{ns}$.

FIGURE 1. TEST CIRCUIT

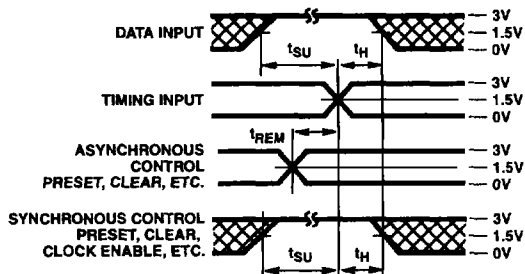

FIGURE 2. SETUP, HOLD, AND RELEASE TIMING

SWITCH POSITION	
TEST	SWITCH
t_{PLZ}, t_{PZL} , Open Drain	6V
t_{PHZ}, t_{PZH}	GND
t_{PLH}, t_{PHL}	Open

DEFINITIONS:

C_L = Load capacitance, includes jig and probe capacitance.

R_T = Termination resistance, should be equal to Z_{OUT} of the Pulse Generator.

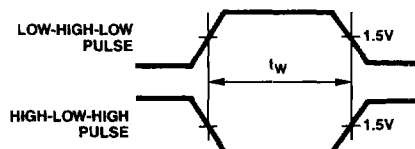

FIGURE 3. PULSE WIDTH

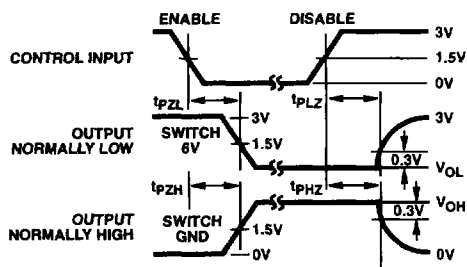

FIGURE 4. ENABLE AND DISABLE TIMING

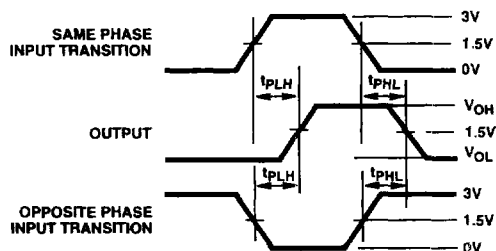

FIGURE 5. PROPAGATION DELAY