

60 V, 1 A low drop power Schottky rectifier

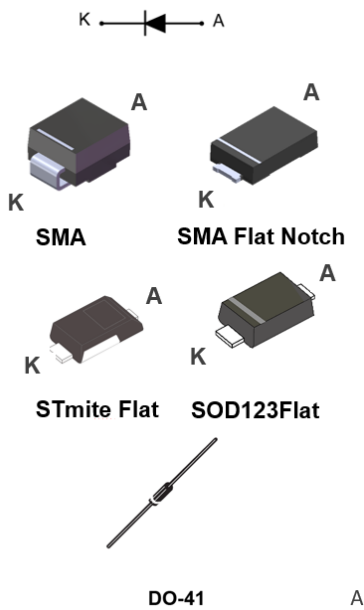

Features

- Negligible switching losses
- Low forward voltage drop
- Surface mount miniature packages
- Avalanche rated
- ECOPACK2 compliant

Applications

- Lighting
- Desktop power supply
- Battery charger
- Set top box
- Auxiliary power

Description

Axial and surface mount power Schottky rectifiers suited to switched mode power supplies and high frequency DC to DC converters.

Packaged in SMA, SMA Flat Notch, STmite flat, DO-41 and SOD123Flat, the **STPS1L60** is ideal for use in low voltage, high frequency inverters and small battery chargers.

Product status	
STPS1L60	
Product summary	
Symbol	Value
$I_{F(AV)}$	1 A
V_{RRM}	60 V
$T_{j(max.)}$	175 °C
$V_{F(typ.)}$	0.50 V

1 Characteristics

Table 1. Absolute ratings (limiting values at 25 °C, unless otherwise specified)

Symbol	Parameter		Value	Unit	
V _{RRM}	Repetitive peak reverse voltage		60	V	
I _{F(RMS)}	Forward rms current	SMA/DO-41	10	A	
		STmite flat	2		
I _{F(AV)}	Average forward current $\delta = 0.5$, square wave	SMA	T _L = 155 °C	1	A
		SMA Flat Notch	T _L = 160 °C		
		DO-41	T _L = 145 °C		
		SOD123 Flat	T _L = 160 °C		
		STmite flat	T _C = 160 °C		
I _{FSM}	Surge non repetitive forward current	SMA, DO-41, STmite flat	t _p = 10 ms sinusoidal	40	A
		SMA Flat Notch		60	
		SOD123 Flat		50	
P _{ARM}	Repetitive peak avalanche power		t _p = 10 μs, T _j = 125 °C	85	W
T _{stg}	Storage temperature range		-65 to +175		°C
T _j	Operating junction temperature ⁽¹⁾		+175		°C

1. $(dP_{tot}/dT_j) < (1/R_{th(j-a)})$ condition to avoid thermal runaway for a diode on its own heatsink.

Table 2. Thermal resistance parameters

Symbol	Parameter		Max. value	Unit
R _{th(j-l)}	Junction to lead	SMA	30	°C/W
		SMA Flat Notch	20	
		DO-41/lead length = 10 mm	45	
		SOD123 Flat	20	
R _{th(j-c)}	Junction to case	STmite flat	20	

For more information, please refer to the following application note :

- AN5088 : Rectifiers thermal management, handling and mounting recommendations

Table 3. Static electrical characteristics

Symbol	Parameter	Test conditions		Min.	Typ.	Max.	Unit
I _R ⁽¹⁾	Reverse leakage current	T _j = 25 °C	V _R = V _{RRM}	-		50	μA
		T _j = 100 °C		-	1.5	5	mA
		T _j = 125 °C		-	5.6	21	

Symbol	Parameter	Test conditions		Min.	Typ.	Max.	Unit
$V_F^{(1)}$	Forward voltage drop	$T_j = 25\text{ °C}$	$I_F = 1\text{ A}$	-		0.57	V
		$T_j = 125\text{ °C}$		-	0.50	0.54	
		$T_j = 25\text{ °C}$	$I_F = 2\text{ A}$	-		0.75	
		$T_j = 125\text{ °C}$		-	0.60	0.66	

1. Pulse test: $t_p = 380\ \mu\text{s}$, $\delta < 2\%$

To evaluate the conduction losses, use the following equation:

$$P = 0.42 \times I_{F(AV)} + 0.12 \times I_{F(RMS)}^2$$

For more information, please refer to the following application notes related to the power losses :

- AN604: Calculation of conduction losses in a power rectifier
- AN4021: Calculation of reverse losses on a power diode

1.1 Characteristics (curves)

Figure 1. Average forward power dissipation versus average forward current

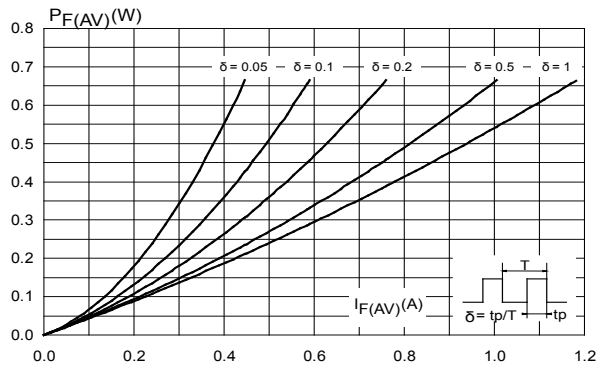

Figure 2. Average forward current versus ambient temperature ($\delta = 0.5$)

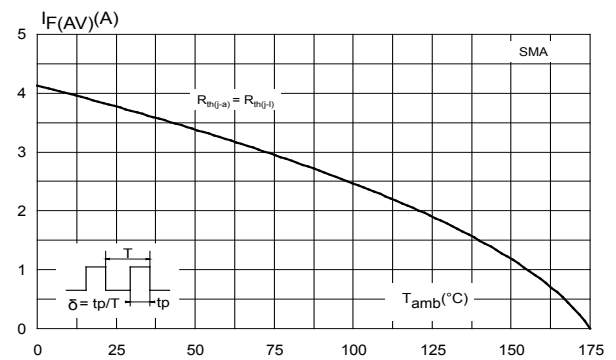

Figure 3. Average forward current versus ambient temperature ($\delta = 0.5$)

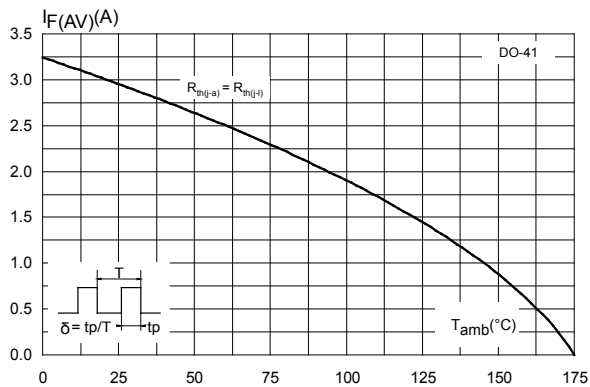

Figure 4. Average forward current versus ambient temperature ($\delta = 0.5$)

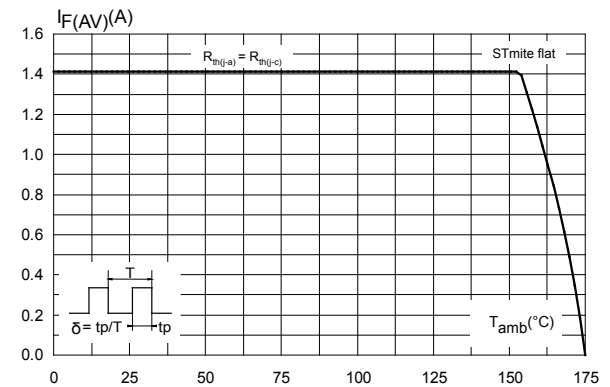

Figure 5. Average forward current versus ambient temperature ($\delta = 0.5$)

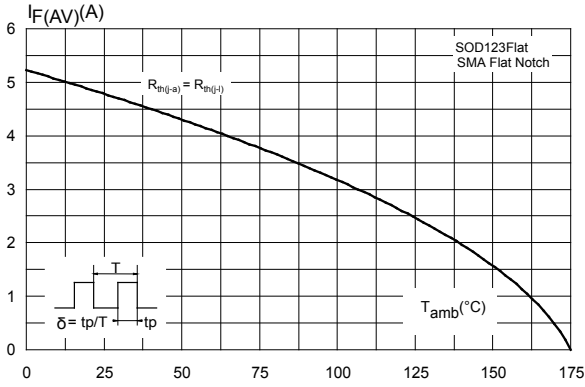

Figure 6. Normalized avalanche power derating versus pulse duration ($T_j = 125^\circ\text{C}$)

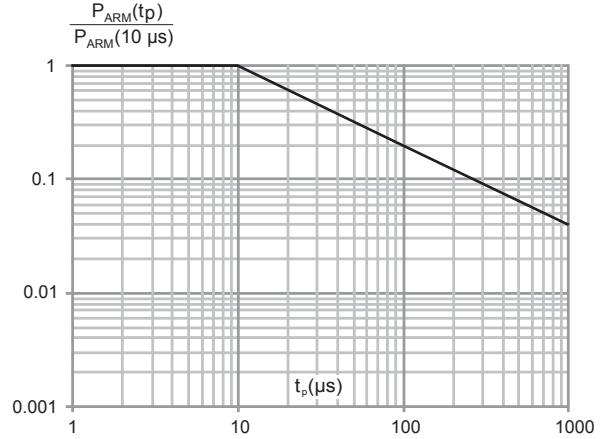

Figure 7. Relative variation of thermal impedance junction to ambient versus pulse duration

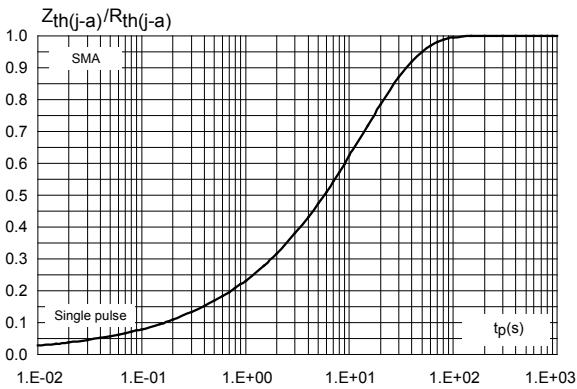

Figure 8. Relative variation of thermal impedance junction to ambient versus pulse duration

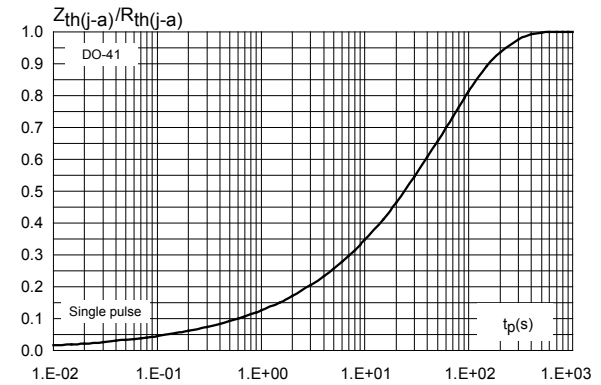

Figure 9. Relative variation of thermal impedance junction to ambient versus pulse duration

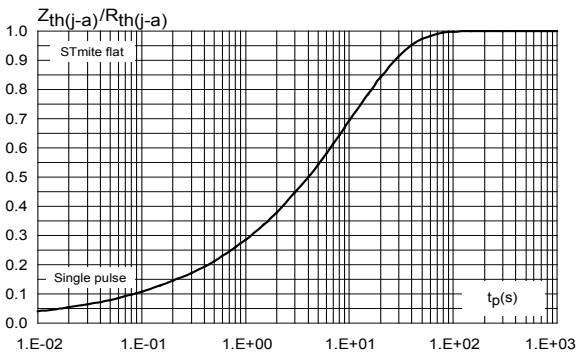

Figure 10. Relative variation of thermal impedance junction to lead versus pulse duration

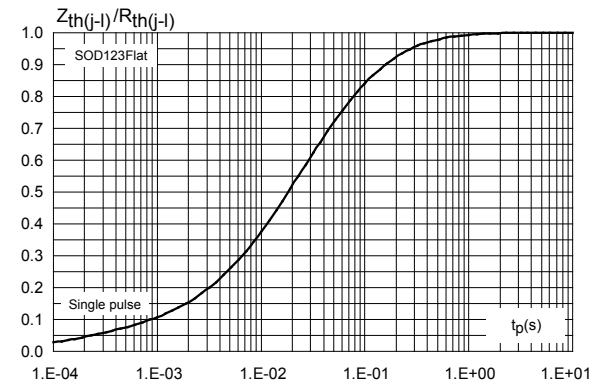

Figure 11. Reverse leakage current versus reverse voltage applied (typical values)

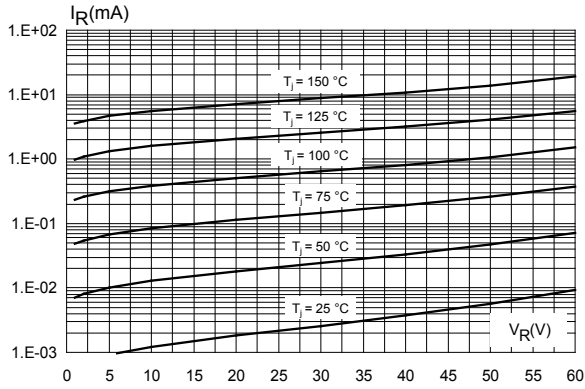

Figure 12. Junction capacitance versus reverse voltage applied (typical values)

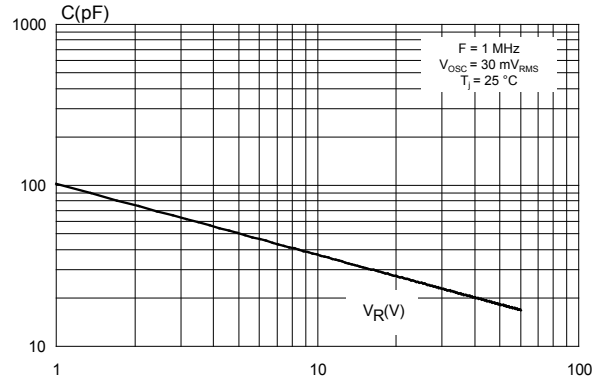

Figure 13. Forward voltage drop versus forward current (typical values)

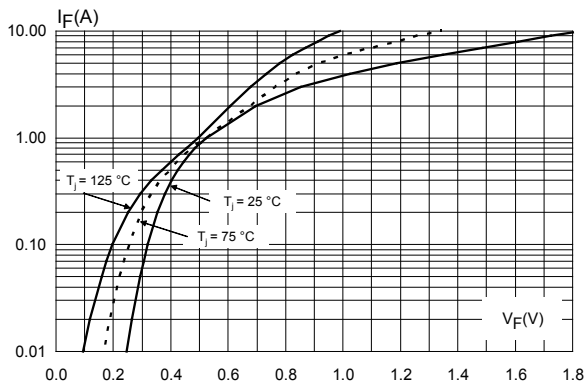

Figure 14. Thermal resistance junction to ambient versus copper surface under each lead (typical values)

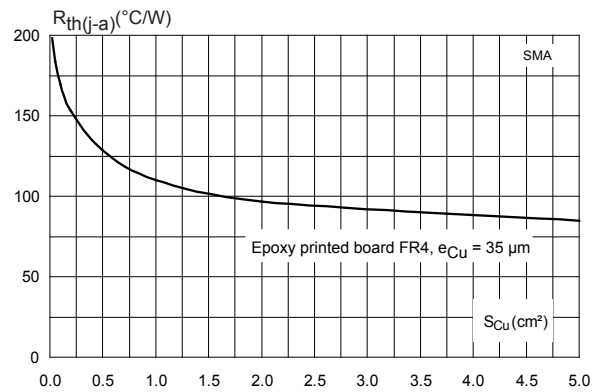

Figure 15. Thermal resistance junction to ambient versus copper surface under tab (typical values)

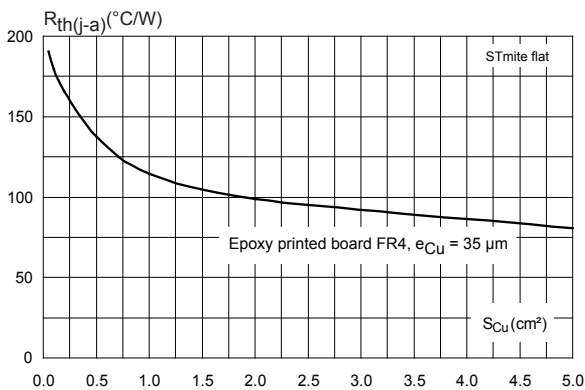

Figure 16. Thermal resistance junction to ambient versus copper surface under each lead (typical values)

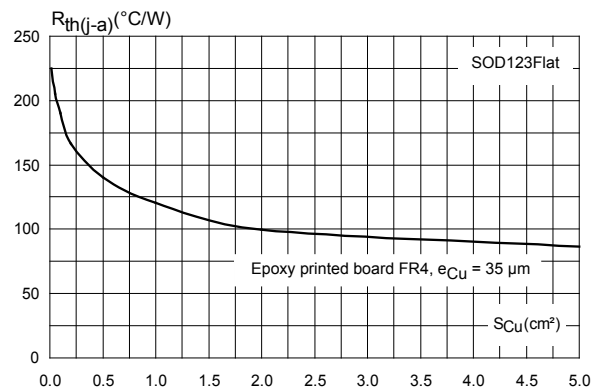

Figure 17. Thermal resistance versus lead length

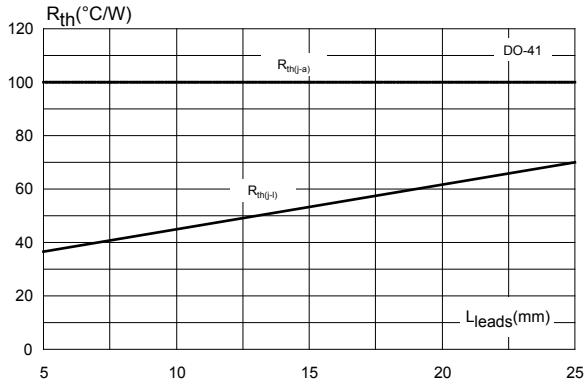
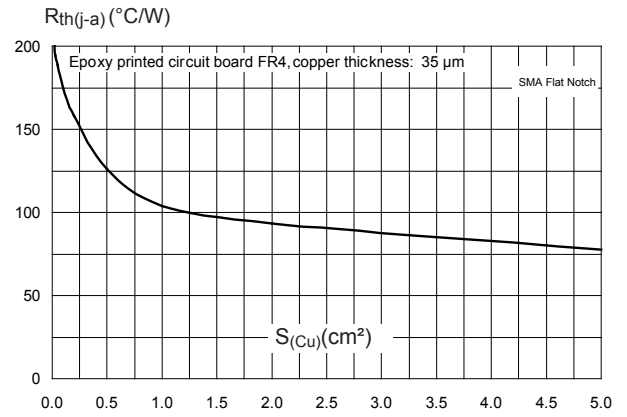

Figure 18. Thermal resistance junction to ambient versus copper surface under each lead (SMA Flat Notch)



2 Package information

In order to meet environmental requirements, ST offers these devices in different grades of **ECOPACK** packages, depending on their level of environmental compliance. ECOPACK specifications, grade definitions and product status are available at: www.st.com. ECOPACK is an ST trademark.

2.1 SMA package information

- Epoxy meets UL94, V0
- Cooling method : by conduction (C)

Figure 19. SMA package outline

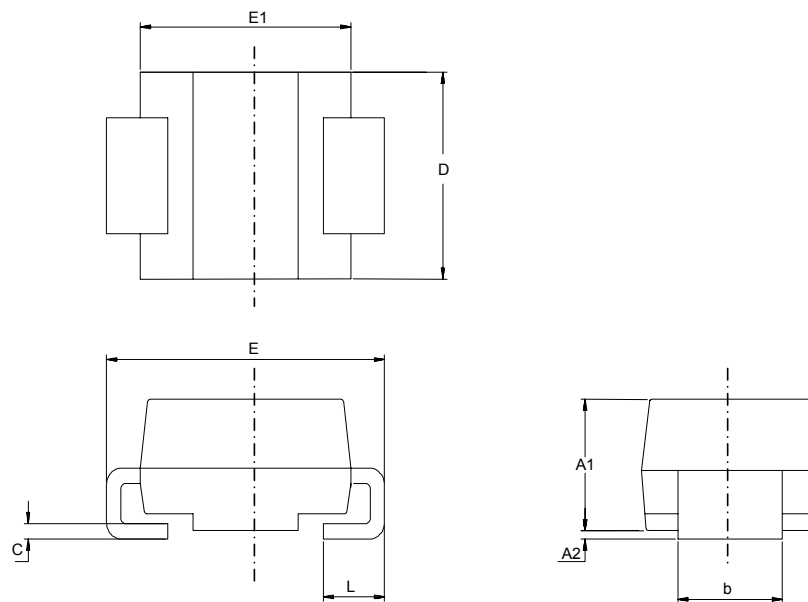
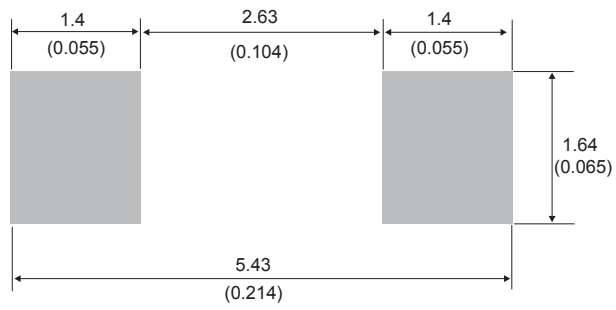

Table 4. SMA package mechanical data

Ref.	Dimensions			
	Millimeters		Inches (for reference only)	
	Min.	Max.	Min.	Max.
A1	1.90	2.45	0.074	0.097
A2	0.05	0.20	0.001	0.008
b	1.25	1.65	0.049	0.065
c	0.15	0.40	0.005	0.016
D	2.25	2.90	0.088	0.115
E	4.80	5.35	0.188	0.211
E1	3.95	4.60	0.155	0.182
L	0.75	1.50	0.029	0.060

Figure 20. SMA recommended footprint in mm (inches)



2.2 SMA Flat Notch package information

- Epoxy meets UL94, V0
- Cooling method: by conduction (C)
- Band indicates cathode

Figure 21. SMA Flat Notch package outline

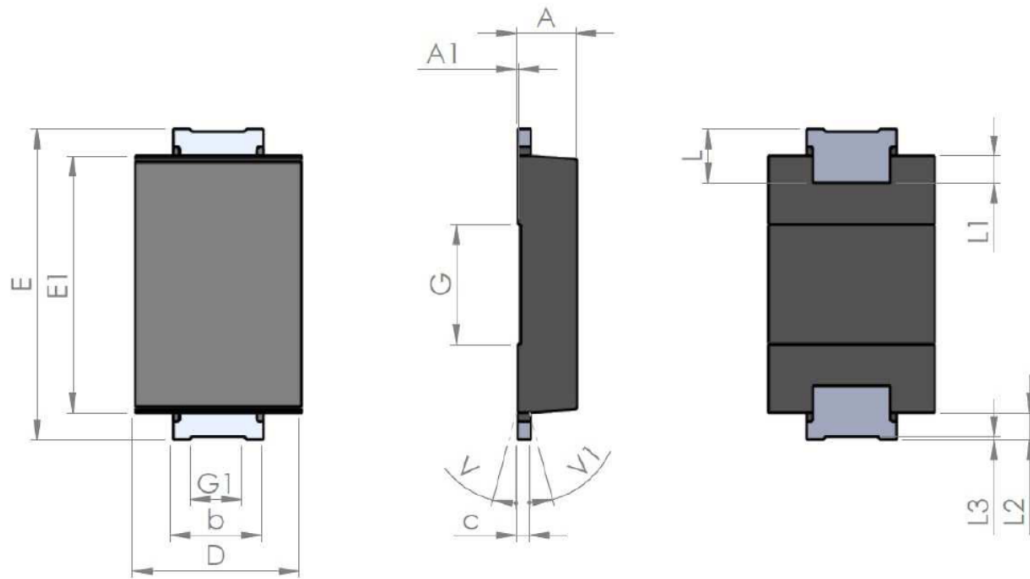
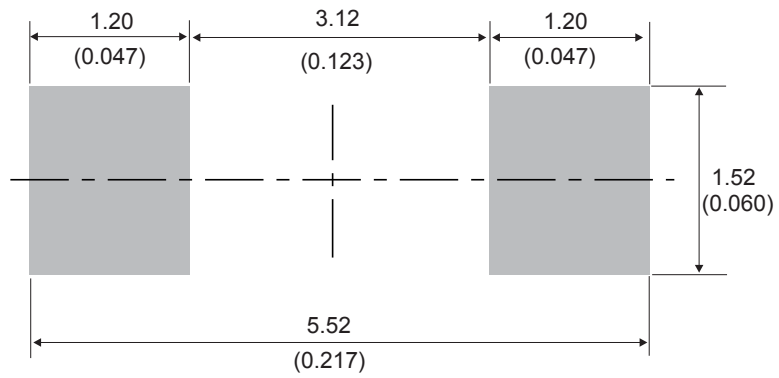

Table 5. SMA Flat Notch package mechanical data

Ref.	Dimensions					
	Millimeters			Inches (for reference only)		
	Min.	Typ.	Max.	Min.	Typ.	Max.
A1	0.90		1.10	0.035		0.044
A1		0.05			0.002	
b	1.25		1.65	0.049		0.065
C	0.15		0.40	0.005		0.016
D	2.25		2.90	0.088		0.115
E	5.00		5.35	0.196		0.211
E1	3.95		4.60	0.155		0.182
G		2.00			0.079	
G1		0.85			0.033	
L	0.75		1.20	0.029		
L1		0.45			0.018	
L2		0.45			0.018	
L3		0.05			0.002	
V			8°			8°
V1			8°			8°

Figure 22. SMA Flat Notch recommended footprint in mm (inches)



2.3 DO-41 package information

- Epoxy meets UL 94, V0

Figure 23. DO-41 package outline

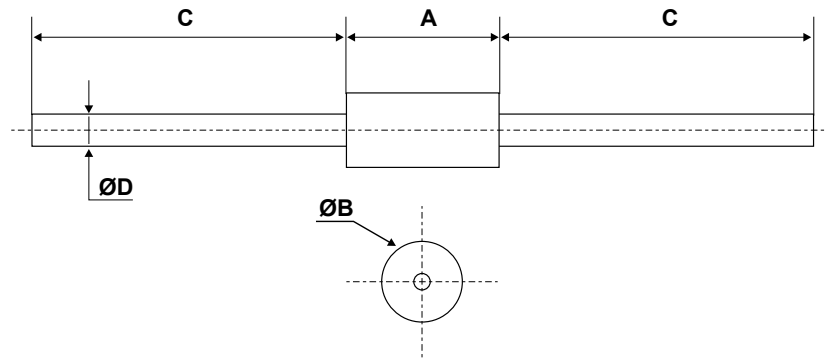

Table 6. DO-41 package mechanical data

Ref.	Dimensions					
	Millimeters			Inches (for reference only)		
	Min.	Typ.	Max.	Min.	Typ.	Max.
A	4.07	-	5.20	0.160	-	0.205
B	2.04	-	2.71	0.080	-	0.107
C	25.40	-		1.000	-	
D	0.71	-	0.86	0.028	-	0.0034

2.4 SOD123 Flat package information

Figure 24. SOD123Flat package outline

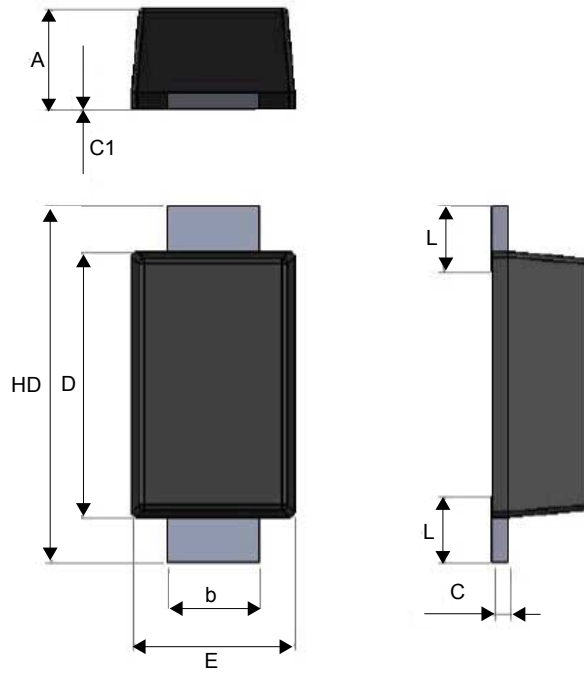
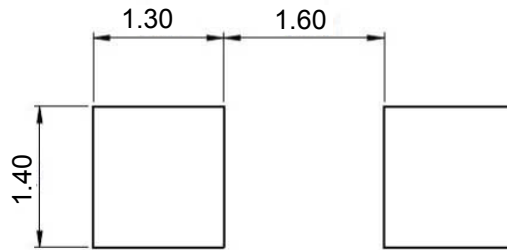

Table 7. SOD123Flat package mechanical data

Ref.	Dimensions					
	Millimeters			Inches (for reference only)		
	Min.	Typ.	Max.	Min.	Typ.	Max.
A	0.86	0.98	1.10	0.034	0.038	0.043
b	0.80	0.90	1.00	0.031	0.035	0.039
c	0.08	0.15	0.25	0.003	0.006	0.009
c1	0.00		0.10	0.000		0.004
D	2.50	2.60	2.70	0.098	0.102	0.106
E	1.50	1.60	1.80	0.059	0.063	0.070
HD	3.30	3.50	3.70	0.130	0.137	0.146
L	0.45	0.65	0.85	0.018	0.025	0.033

Figure 25. SOD123Flat footprint dimensions (mm)



2.5 STmiteFlat package information

- Epoxy meets UL 94,V0

Figure 26. STmite Flat package outline

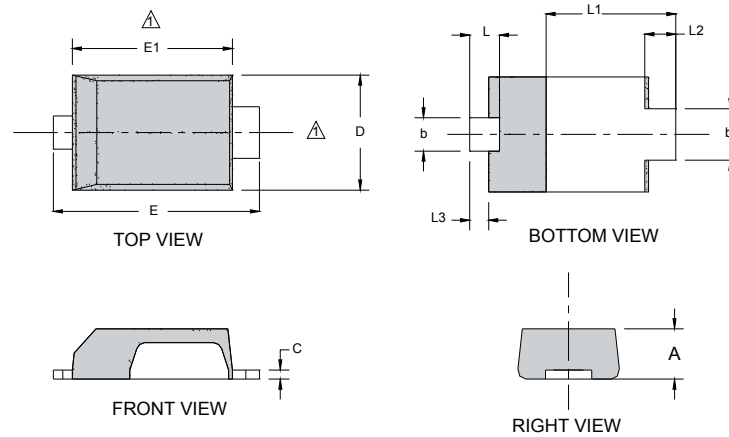
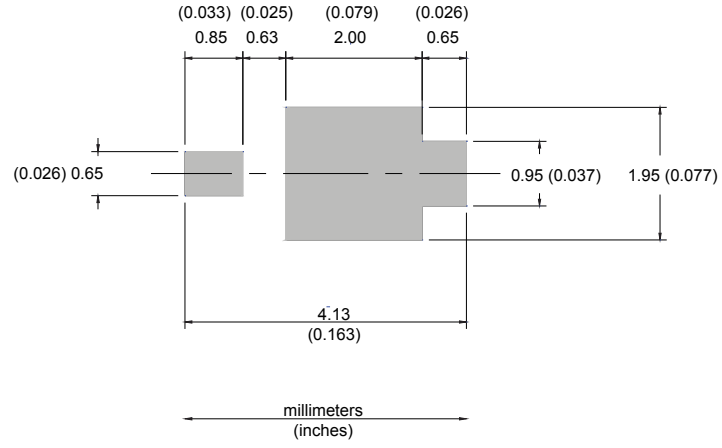

Table 8. STmite Flat package mechanical data

Ref.	Dimensions					
	Millimeters			Inches (for reference only)		
	Min.	Typ.	Max.	Min.	Typ.	Max.
A	0.80	0.85	0.95	0.031	0.033	0.037
b	0.40	0.55	0.65	0.016	0.022	0.026
b2	0.70	0.85	1.00	0.027	0.033	0.039
c	0.10	0.15	0.25	0.004	0.006	0.009
D	1.75	1.90	2.05	0.069	0.075	0.081
E	3.60	3.80	3.90	0.142	0.150	0.154
E1	2.80	2.95	3.10	0.110	0.116	0.122
L	0.50	0.55	0.80	0.020	0.022	0.031
L1	2.10	2.40	2.60	0.083	0.094	0.102
L2	0.45	0.60	0.75	0.018	0.024	0.030
L3	0.20	0.35	0.50	0.008	0.014	0.020

Figure 27. STmite Flat Recommended footprint



3 Ordering information

Table 9. Ordering information

Order code	Marking	Package	Weight	Base qty.	Delivery mode
STPS1L60A	GB6	SMA	68 mg	5000	Tape and reel
STPS1L60AFN	A16	SMA Flat Notch	39 mg	10 000	Tape and reel
STPS1L60RL	STPS1L60	DO-41	340 mg	5000	Tape and reel
STPS1L60MF	F1L6	STmite flat	16 mg	12000	Tape and reel
STPS1L60ZF	1L6	SOD123 Flat	12.5 mg	3000	Tape and reel

Revision history

Table 10. Document revision history

Date	Revision	Changes
Jul-2003	5A	Last update.
Aug-2004	6	SMA package dimensions update. Reference A1 max. changed from 2.70 mm (0.106 inch.) to 2.03 mm (0.080 inc.).
25-Jun-2009	7	Added STmite flat package. Updated ECOPACK statement.
30-Sep-2009	8	Updated table 7 ref. "C"
9-Aug-2016	9	Added SOD123Flat package.
26-Aug-2016	10	Updated table 4.
05-Dec-2018	11	Updated Section Features and Table 1 . Absolute ratings (limiting values at 25 °C, unless otherwise specified).
27-Sep-2019	12	Added Section 2.2 SMA Flat Notch package information.

IMPORTANT NOTICE – PLEASE READ CAREFULLY

STMicroelectronics NV and its subsidiaries (“ST”) reserve the right to make changes, corrections, enhancements, modifications, and improvements to ST products and/or to this document at any time without notice. Purchasers should obtain the latest relevant information on ST products before placing orders. ST products are sold pursuant to ST’s terms and conditions of sale in place at the time of order acknowledgement.

Purchasers are solely responsible for the choice, selection, and use of ST products and ST assumes no liability for application assistance or the design of Purchasers’ products.

No license, express or implied, to any intellectual property right is granted by ST herein.

Resale of ST products with provisions different from the information set forth herein shall void any warranty granted by ST for such product.

ST and the ST logo are trademarks of ST. For additional information about ST trademarks, please refer to www.st.com/trademarks. All other product or service names are the property of their respective owners.

Information in this document supersedes and replaces information previously supplied in any prior versions of this document.

© 2019 STMicroelectronics – All rights reserved