

MC75172B, MC75174B

Quad EIA-485 Line Drivers with Three-State Outputs

The ON Semiconductor MC75172B/174B Quad Line drivers are differential high speed drivers designed to comply with the EIA-485 Standard. Features include three-state outputs, thermal shutdown, and output current limiting in both directions. These devices also comply with EIA-422-A, and CCITT Recommendations V.11 and X.27.

The MC75172B/174B are optimized for balanced multipoint bus transmission at rates in excess of 10 MBPS. The outputs feature wide common mode voltage range, making them suitable for party line applications in noisy environments. The current limit and thermal shutdown features protect the devices from line fault conditions. These devices offer optimum performance when used with the MC75173 and MC75175 line receivers.

Both devices are available in 16-pin plastic PDIP and 20-pin wide body surface mount packages.

Features

- Meets EIA-485 Standard for Party Line Operation
- Meets EIA-422-A and CCITT Recommendations V.11 and X.27
- Operating Ambient Temperature: -40°C to +85°C
- High Impedance Outputs
- Common Mode Output Voltage Range: -7.0 to 12 V
- Positive and Negative Current Limiting
- Transmission Rates in Excess of 10 MBPS
- Thermal Shutdown at 150°C Junction Temperature, ($\pm 20^\circ\text{C}$)
- Single 5.0 V Supply
- Pin Compatible with TI SN75172/4 and NS $\mu\text{A}96172/4$
- Interchangeable with MC3487 and AM26LS31 for EIA-422-A Applications
- Pb-Free Packages are Available*

MAXIMUM RATING

Rating	Symbol	Value	Unit
Power Supply Voltage	V_{CC}	-0.5, +7.0	Vdc
Input Voltage (Data, Enable)	V_{in}	+7.0	Vdc
Input Current (Data, Enable)	I_{in}	-24	mA
Applied Output Voltage, when in 3-State Condition ($V_{CC} = 5.0\text{ V}$)	V_{za}	-10, +14	Vdc
Applied Output Voltage, when $V_{CC} = 0\text{ V}$	V_{zb}	± 14	Vdc
Output Current	I_O	Self-Limiting	-
Storage Temperature	T_{stg}	-65, +150	°C

Stresses exceeding Maximum Ratings may damage the device. Maximum Ratings are stress ratings only. Functional operation above the Recommended Operating Conditions is not implied. Extended exposure to stresses above the Recommended Operating Conditions may affect device reliability.

1. Devices should not be operated at these limits. The "Recommended Operating Conditions" table provides for actual device operation.

*For additional information on our Pb-Free strategy and soldering details, please download the ON Semiconductor Soldering and Mounting Techniques Reference Manual, SOLDERRM/D.



ON Semiconductor®

<http://onsemi.com>

QUAD EIA-485 LINE DRIVERS

SOIC-20 WB
DW SUFFIX
CASE 751D

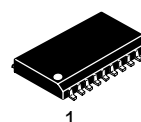

PDIP-16
P SUFFIX
CASE 648

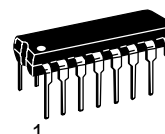

MARKING DIAGRAMS

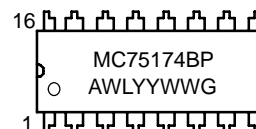
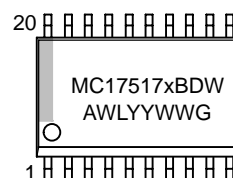

- x = 2 or 4
- A = Assembly Location
- WL = Wafer Lot
- YY = Year
- WW = Work Week
- G = Pb-Free Package

ORDERING INFORMATION

See detailed ordering and shipping information in the package dimensions section on page 11 of this data sheet.

MC75172B, MC75174B

RECOMMENDED OPERATING CONDITIONS

Characteristic	Symbol	Min	Typ	Max	Unit
Power Supply Voltage	V_{CC}	+4.75	+5.0	+5.25	Vdc
Input Voltage (All Inputs)	V_{in}	0	–	V_{CC}	Vdc
Output Voltage in 3–State Condition, or when $V_{CC} = 0$ V	V_{cm}	–7.0	–	+12	Vdc
Output Current (Normal data transmission)	I_O	–65	–	+65	mA
Operating Ambient Temperature (see text) EIA–485 EIA–422	T_A	–40 0	–	+85	°C

2. All limits are not necessarily functional concurrently.

ELECTRICAL CHARACTERISTICS ($-40^{\circ}\text{C} \leq T_A \leq 85^{\circ}\text{C}$, $4.75\text{ V} \leq V_{CC} \leq 5.25\text{ V}$, unless otherwise noted.)

Characteristic	Symbol	Min	Typ	Max	Unit
Output Voltage					Vdc
Single–Ended Voltage					
$I_O = 0$	V_O	0	–	6.0	
High @ $I_O = -33\text{ mA}$	V_{OH}	–	4.0	–	
Low @ $I_O = +33\text{ mA}$	V_{OL}	–	1.6	–	
Differential Voltage					
Open Circuit ($I_O = 0$)	$ V_{OD1} $	1.5	3.4	6.0	
$R_L = 54\ \Omega$ (Figure 1)	$ V_{OD2} $	1.5	2.3	5.0	
Change in Differential*, $R_L = 54\ \Omega$ (Figure 1)	$ \Delta V_{OD2} $	–	5.0	200	mVdc
Differential Voltage, $R_L = 100\ \Omega$ (Figure 1)	$ V_{OD2A} $	–	2.2	–	Vdc
Change in Differential*, $R_L = 100\ \Omega$ (Figure 1)	$ \Delta V_{OD2A} $	–	5.0	200	mVdc
Differential Voltage, $-7.0\text{ V} \leq V_{cm} \leq 12\text{ V}$ (Figure 2)	$ V_{OD3} $	1.5	–	5.0	Vdc
Change in Differential*, $-7.0\text{ V} \leq V_{cm} \leq 12\text{ V}$ (Figure 2)	$ \Delta V_{OD3} $	–	5.0	200	mVdc
Offset Voltage, $R_L = 54\ \Omega$ (Figure 1)	V_{OS}	–	2.9	–	Vdc
Change in Offset*, $R_L = 54\ \Omega$ (Figure 1)	$ \Delta V_{OS} $	–	5.0	200	mVdc
Output Current (Each Output)					μA
Power Off Leakage, $V_{CC} = 0$, $-7.0\text{ V} \leq V_O \leq 12\text{ V}$	$I_{O(off)}$	–50	0	+50	
Leakage in 3–State Mode, $-7.0\text{ V} \leq V_O \leq 12\text{ V}$	I_{OZ}	–50	0	+50	
Short Circuit Current to Ground	I_{OSR}	–150	–	+150	mA
Short Circuit Current, $-7.0\text{ V} \leq V_O \leq 12\text{ V}$	I_{OS}	–250	–	+250	
Inputs					Vdc
Low Level Voltage (Pins 4 & 12, MC75174B only)	$V_{IL(A)}$	0	–	0.7	
Low Level Voltage (All Other Pins)	$V_{IL(B)}$	0	–	0.8	
High Level Voltage (All Inputs)	V_{IH}	2.0	–	V_{CC}	
Current @ $V_{in} = 2.7\text{ V}$ (All Inputs)	I_{IH}	–	0.2	20	μA
Current @ $V_{in} = 0.5\text{ V}$ (All Inputs)	I_{IL}	–100	–15	–	
Clamp Voltage (All Inputs, $I_{in} = -18\text{ mA}$)	V_{IK}	–1.5	–	–	Vdc
Thermal Shutdown Junction Temperature	T_{jts}	–	+150	–	°C
Power Supply Current (Outputs Open, $V_{CC} = 5.25\text{ V}$)	I_{CC}				mA
Outputs Enable		–	60	70	
Outputs Disabled		–	30	40	

3. * V_{in} switched from 0.8 to 2.0 V. Typical values determined at 25°C ambient and 5.0 V supply.

MC75172B, MC75174B

TIMING CHARACTERISTICS ($T_A = 25^\circ\text{C}$, $V_{CC} = 5.0\text{ V}$)

Characteristics	Symbol	Min	Typ	Max	Unit
Propagation Delay – Input to Single-ended Output (Figure 3) Output Low-to-High Output High-to-Low	t_{PLH} t_{PHL}	– –	23 18	30 30	ns
Propagation Delay – Input to Differential Output (Figure 4) Input Low-to-High Input High-to-Low	$t_{PLH(D)}$ $t_{PHL(D)}$	– –	15 17	25 25	ns
Differential Output Transition Time (Figure 4)	t_{dr} , t_{df}	–	19	25	ns
Skew Timing $ t_{PLHD} - t_{PHLD} $ for Each Driver Max – Min t_{PLHD} Within a Package Max – Min t_{PHLD} Within a Package	t_{SK1} t_{SK2} t_{SK3}	– – –	0.2 1.5 1.5	– – –	ns
Enable Timing Single-ended Outputs (Figure 5) Enable to Active High Output Enable to Active Low Output Active High to Disable (using Enable) Active Low to Disable (using Enable) Enable to Active High Output (MC75172B only) Enable to Active Low Output (MC75172B only) Active High to Disable (using $\overline{\text{Enable}}$, MC75172B only) Active Low to Disable (using $\overline{\text{Enable}}$, MC75172B only)	$t_{PZH(E)}$ $t_{PZL(E)}$ $t_{PHZ(E)}$ $t_{PLZ(E)}$ $t_{PZH(E)}$ $t_{PZL(E)}$ $t_{PHZ(E)}$ $t_{PLZ(E)}$	– – – – – – – –	48 20 35 30 58 28 38 36	60 30 45 50 70 35 50 50	ns
Differential Outputs (Figure 6) Enable to Active Output Enable to Active Output (MC75172B only) Enable to 3-State Output Enable to 3-State Output (MC75172B only)	$t_{PZD(E)}$ $t_{PZD(E)}$ $t_{PDZ(E)}$ $t_{PDZ(E)}$	– – – –	47 56 32 40	– – – –	ns

PIN CONNECTIONS

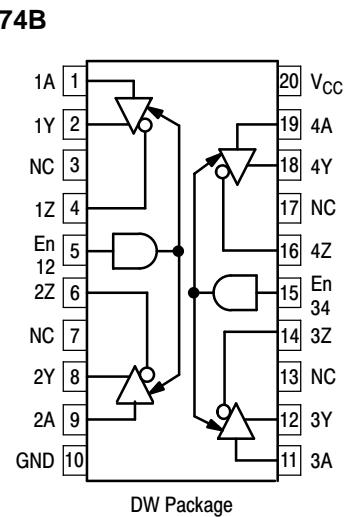
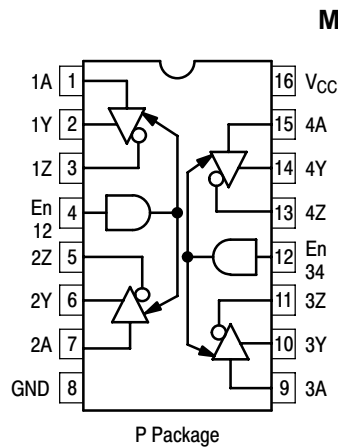
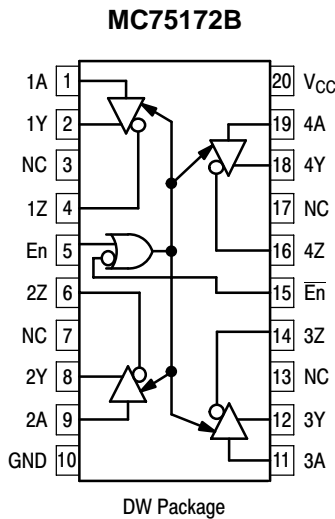

MC75172B, MC75174B

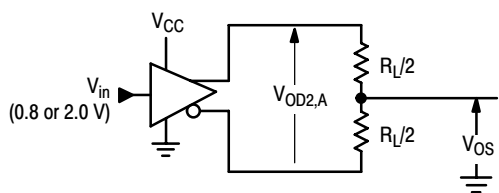

Figure 1. V_{DD} Measurement

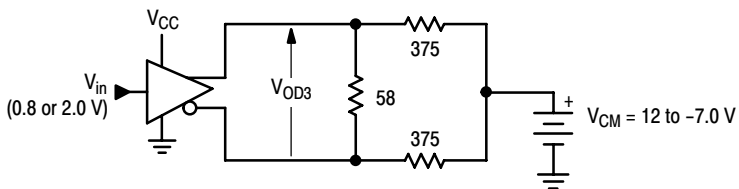

Figure 2. Common Mode Test

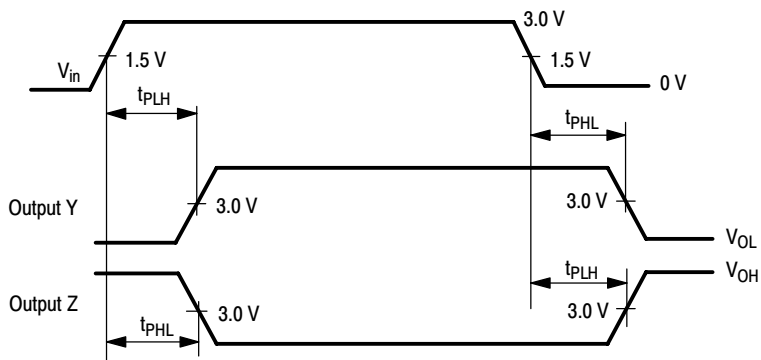
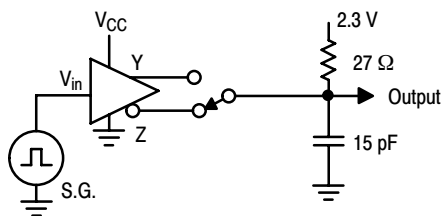
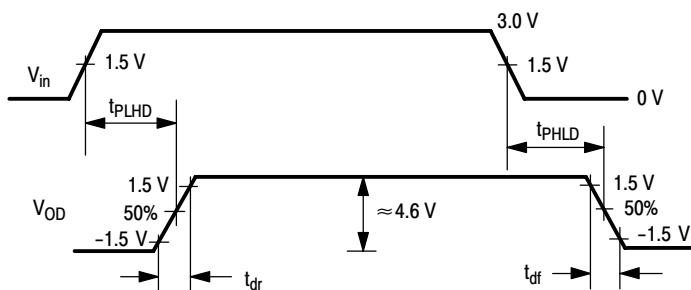
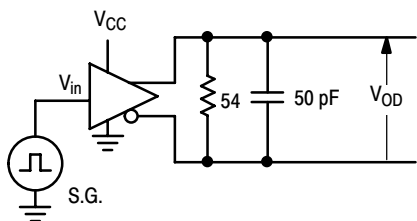

Figure 3. Propagation Delay, Single-Ended Outputs



- NOTES:
1. S.G. set to: $f \leq 1.0$ MHz; duty cycle = 50%; $t_r, t_f \leq 5.0$ ns.
 2. $t_{SK1} = |t_{PLHD} - t_{PHLD}|$ for each driver.
 3. t_{SK2} computed by subtracting the shortest t_{PLHD} from the longest t_{PLHD} of the 4 drivers within a package.
 4. t_{SK3} computed by subtracting the shortest t_{PHLD} from the longest t_{PHLD} of the 4 drivers within a package.

Figure 4. Propagation Delay, Differential Outputs

MC75172B, MC75174B

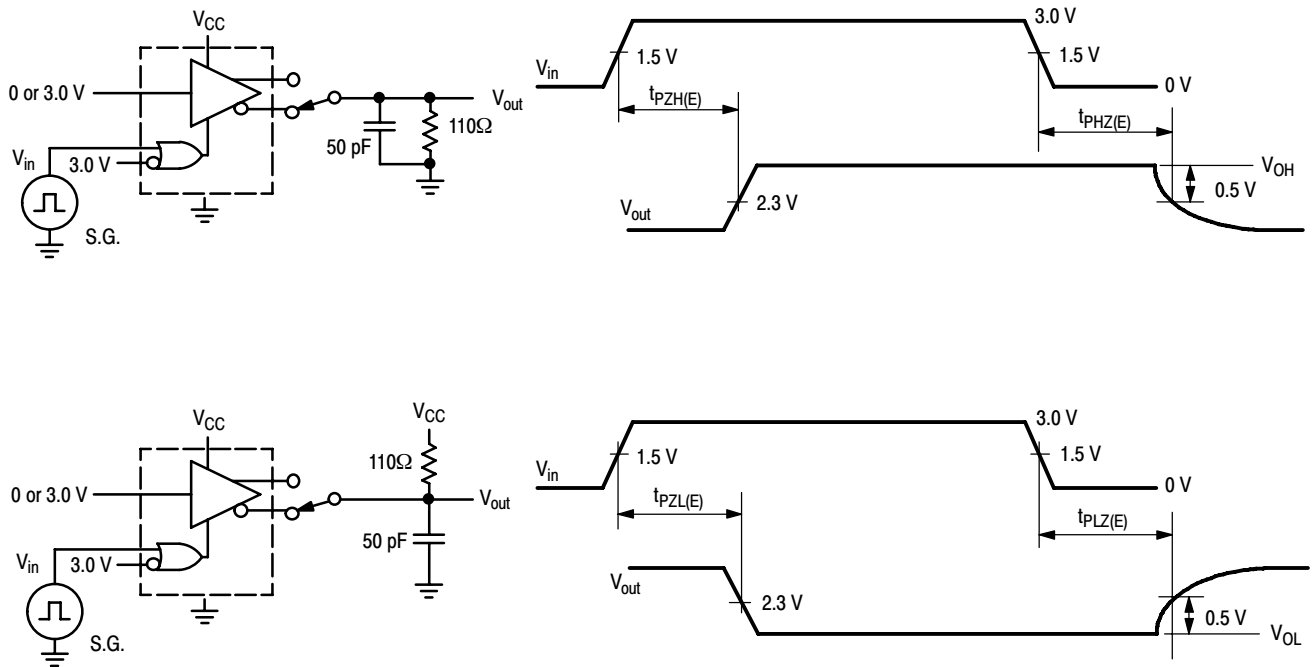
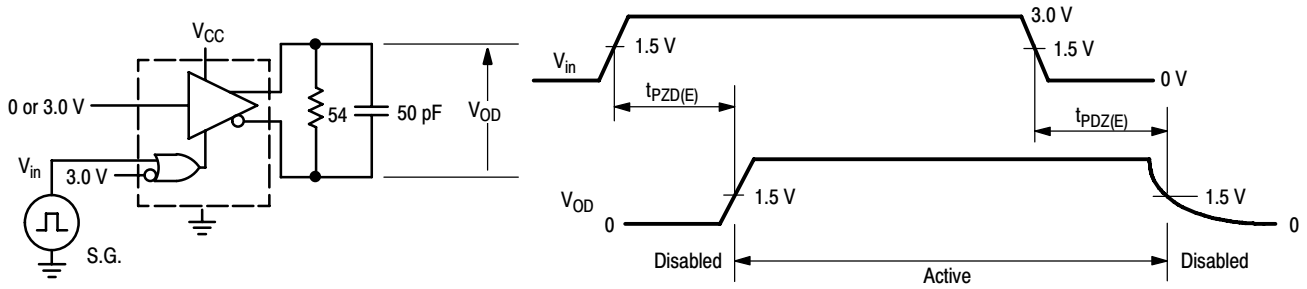

Figure 5. Enable Timing, Single-Ended Outputs



NOTES: 1. S.G. set to: $f \leq 1.0$ MHz; duty cycle = 50%; $t_f, t_r \leq 5.0$ ns.
 2. V_{in} is inverted for $\overline{\text{Enable}}$ measurements.

Figure 6. Enable Timing, Differential Outputs

MC75172B, MC75174B

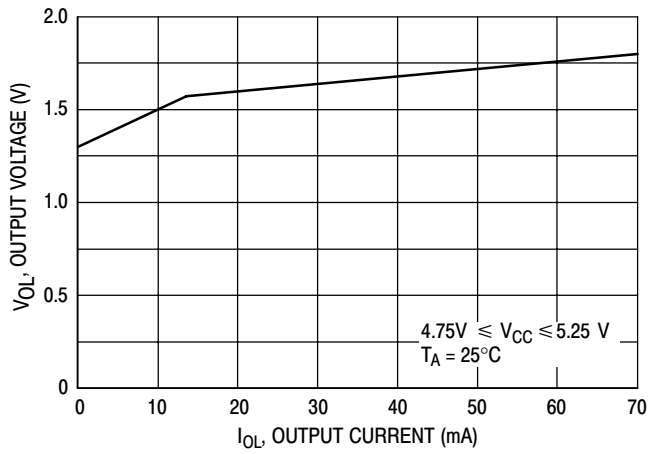

Figure 7. Single-Ended Output Voltage versus Output Sink Current

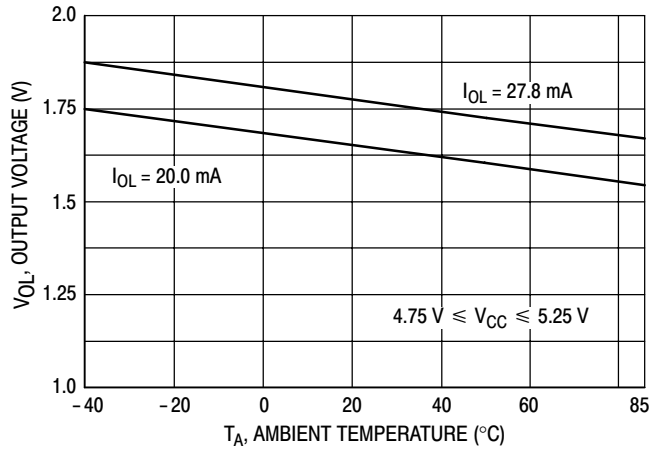

Figure 8. Single-Ended Output Voltage versus Temperature

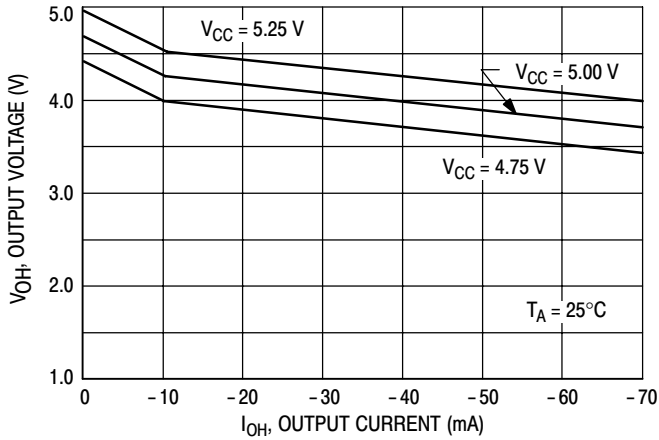

Figure 9. Single-Ended Output Voltage versus Output Source Current

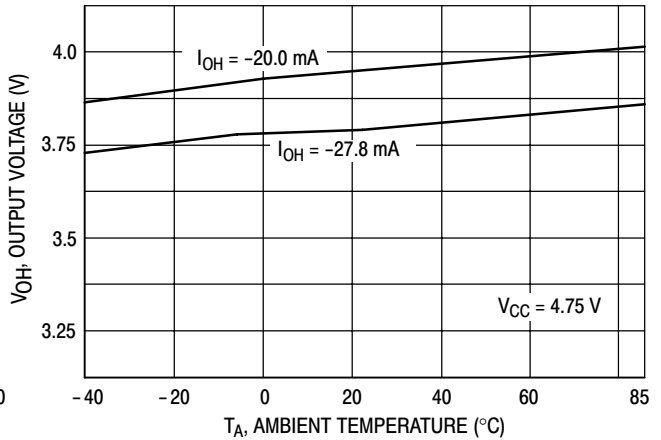

Figure 10. Single-Ended Output Voltage versus Temperature

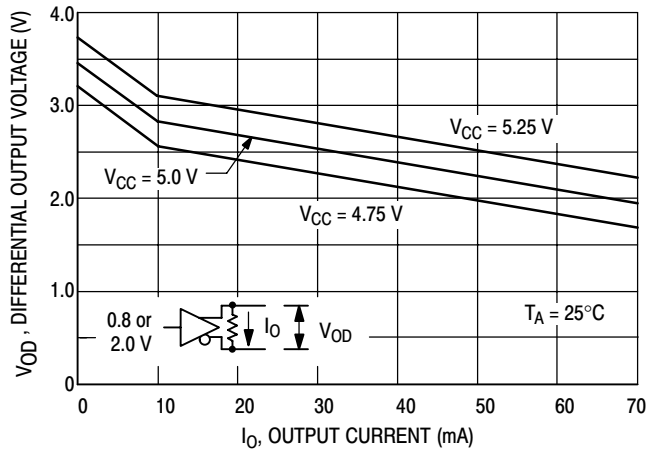

Figure 11. Output Differential Voltage versus Load Current

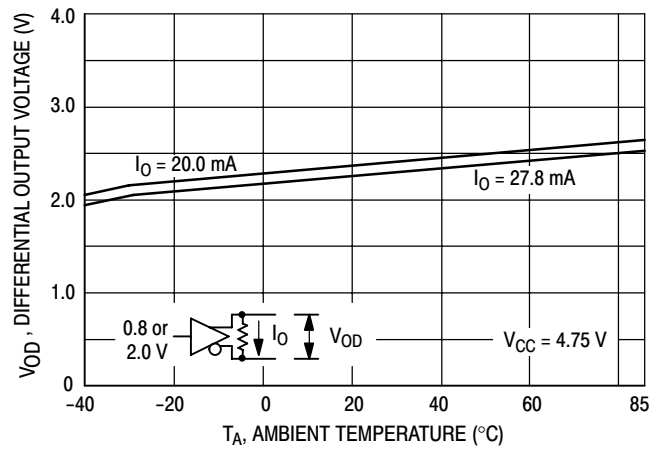

Figure 12. Output Differential Voltage versus Temperature

MC75172B, MC75174B

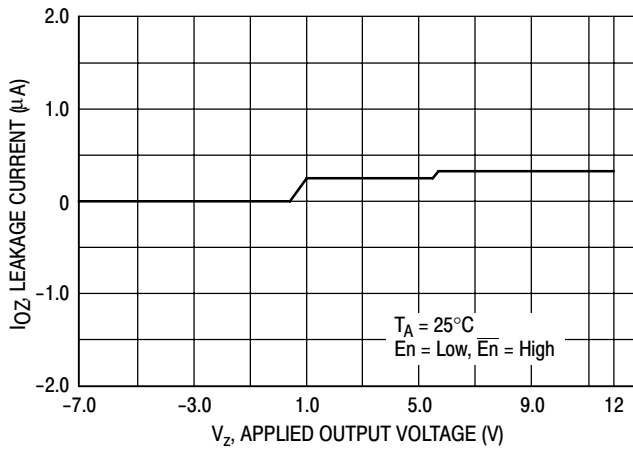

Figure 13. Output Leakage Current versus Output Voltage

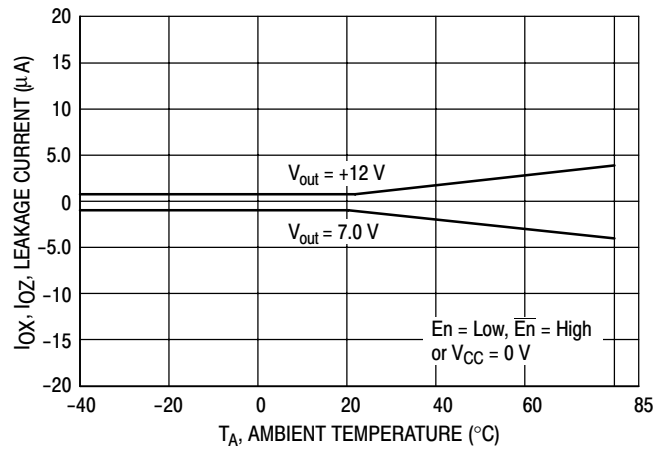

Figure 14. Output Leakage Current versus Temperature

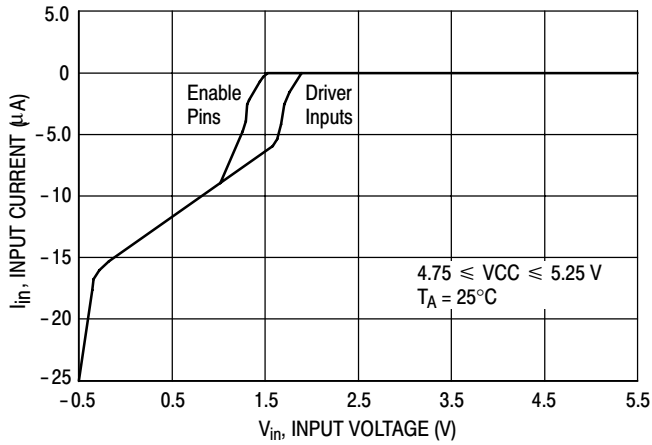

Figure 15. Input Current versus Input Voltage

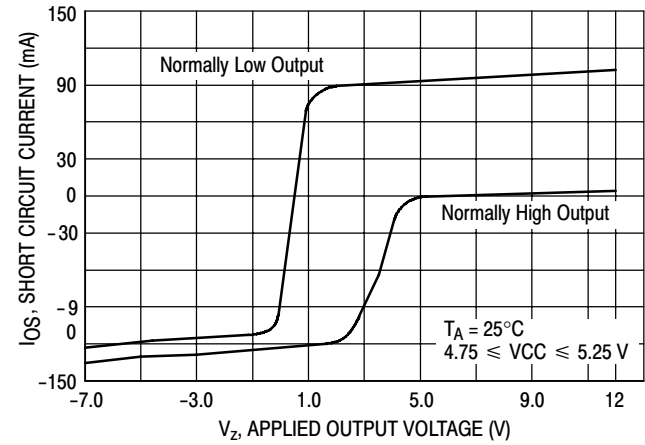

Figure 16. Short Circuit Current versus Common Mode Voltage

MC75172B, MC75174B

APPLICATIONS INFORMATION

Description

The MC75172B and MC75174B are differential line drivers designed to comply with EIA-485 Standard (April 1983) for use in balanced digital multipoint systems containing multiple drivers. The drivers also comply with EIA-422-A and CCITT Recommendations V.11 and X.27. The drivers meet the EIA-485 requirement for protection from damage in the event that two or more drivers attempt to transmit data simultaneously on the same cable. Data rates in excess of 10 MBPS are possible, depending on the cable length and cable characteristics. A single power supply, 5.0 V, $\pm 5\%$, is required at a nominal current of 60 mA, plus load currents.

Outputs

Each output (when active) will be a low or a high voltage, which depends on the input state and the load current (see Table 1, 2 and Figures 7 to 10). The graphs apply to each driver, regardless of how many other drivers within the package are supplying load current.

Table 1. MC75172B Truth Table

Data Input	Enables		Outputs	
	EN	$\overline{\text{EN}}$	Y	Z
H	H	X	H	L
L	H	X	L	H
H	X	L	H	L
L	X	L	L	H
X	L	H	Z	Z

Table 2. MC75174B Truth Table

Data Input	Enable	Outputs	
		Y	Z
H	H	H	L
L	H	L	H
X	L	Z	Z

H = Logic high, L = Logic low, X = Irrelevant, Z = High impedance

The two outputs of a driver are always complementary. A “high” output can only source current out, while a “low” output can only sink current (except for short circuit current – see Figure 16).

The outputs will be in the high impedance mode when:

- the Enable inputs are set according to Table 1 or 2;
- V_{CC} is less than 1.5 V;
- the junction temperature exceeds the trip point of the thermal shutdown circuit (see below). When in this condition, the output’s source and sink capability are shut off, and only leakage currents will flow (see Figures 13, 14). Disabled outputs may be taken to any voltage between -7.0 V and 12 V without damage.

The drivers are protected from short circuits by two methods:

- Current limiting is provided at each output, in both the source and sink direction, for shorts to any voltage within the range of 12 V to -7.0 V, with respect to circuit ground (see Figure 16). The short circuit current will flow until the fault is removed, or until the thermal shutdown circuit activates (see below). The current limiting circuit has a negative temperature coefficient and requires no resetting upon removal of the fault condition.
- A thermal shutdown circuit disables the outputs when the junction temperature reaches 150°C , $\pm 20^{\circ}\text{C}$. The thermal shutdown circuit has a hysteresis of $\approx 12^{\circ}\text{C}$ to prevent oscillations. When this circuit activates, the output stage of each driver is put into the high impedance mode, thereby shutting off the output currents. The remainder of the internal circuitry remains biased. The outputs will become active once again as the IC cools down.

Driver Inputs

The driver inputs determine the state of the outputs in accordance with Tables 1 and 2. The driver inputs have a nominal threshold of 1.2 V, and their voltage must be kept within the range of 0 V to V_{CC} for proper operation. If the voltage is taken more than 0.5 V below ground, excessive currents will flow, and proper operation of the drivers will be affected. An open pin is equivalent to a logic high, but good design practices dictate that inputs should never be left open. The characteristics of the driver inputs are shown in Figure 15. This graph is not affected by the state of the Enable pins.

Enable Logic

Each driver’s outputs are active when the Enable inputs (Pins 4 and 12) are true according to Tables 1 and 2.

The Enable inputs have a nominal threshold of 1.2 V and their voltage must be kept within the range of 0 V to V_{CC} for proper operation. If the voltage is taken more than 0.5 V below ground, excessive currents will flow, and proper operation of the drivers will be affected. An open pin is equivalent to a logic high, but good design practices dictate that inputs should never be left open. The Enable input characteristics are shown in Figure 15.

Operating Temperature Range

The minimum ambient operating temperature is listed as -40°C to meet EIA-485 specifications, and 0°C to meet EIA-422-A specifications. The higher V_{OD} required by EIA-422-A is the reason for the narrower temperature range.

MC75172B, MC75174B

The maximum ambient operating temperature (applicable to both EIA-485 and EIA-422-A) is listed as 85°C. However, a lower ambient may be required depending on system use (i.e. specifically how many drivers within a package are used) and at what current levels they are operating. The maximum power which may be dissipated within the package is determined by:

$$PD_{\max} = \frac{T_{J\max} - T_A}{R_{\theta JA}}$$

where: $R_{\theta JA}$ = package thermal resistance (typical 70°C/W for the DIP package, 85°C/W for SOIC package);
 $T_{J\max}$ = max. operating junction temperature, and
 T_A = ambient temperature.

Since the thermal shutdown feature has a trip point of 150°C, ±20°C, $T_{J\max}$ is selected to be 130°C. The power dissipated within the package is calculated from:

$$PD = \{[(V_{CC} - V_{OH}) \cdot I_{OH}] + V_{OL} \cdot I_{OL}\} \text{ each driver} + (V_{CC} \cdot I_{CC})$$

where: V_{CC} = the supply voltage;
 V_{OH} , V_{OL} are measured or estimated from Figures 7 to 10;
 I_{CC} = the quiescent power supply current (typical 60 mA).

As indicated in the equation, the first term (in brackets) must be calculated and summed for each of the four drivers, while the last term is common to the entire package.

Example 1: $T_A = 25^\circ\text{C}$, $I_{OL} = I_{OH} = 55 \text{ mA}$ for each driver, $V_{CC} = 5.0 \text{ V}$, DIP package. How many drivers per package can be used?

Maximum allowable power dissipation is:

$$PD_{\max} = \frac{130^\circ\text{C} - 25^\circ\text{C}}{70^\circ\text{C}/\text{W}} = 1.5 \text{ W}$$

Since the power supply current of 60 mA dissipates 300 mW, that leaves 1.2 W (1.5 W – 0.3 W) for the drivers. From Figures 7 and 9, $V_{OL} \approx 1.75 \text{ V}$, and $V_{OH} \approx 3.85 \text{ V}$. The power dissipated in each driver is:

$$\{(5.0 - 3.85) \cdot 0.055\} + (1.75 \cdot 0.055) = 160 \text{ mW.}$$

Since each driver dissipates 160 mW, the four drivers per package could be used in this application.

Example 2: $T_A = 85^\circ\text{C}$, $I_{OL} = 27.8 \text{ mA}$, $I_{OH} = 20 \text{ mA}$ for each driver, $V_{CC} = 5.0 \text{ V}$, SOIC package. How many drivers per package can be used?

Maximum allowable power dissipation is:

$$PD_{\max} = \frac{130^\circ\text{C} - 85^\circ\text{C}}{85^\circ\text{C}/\text{W}} = 0.53 \text{ W}$$

Since the power supply current of 60 mA dissipates 300 mW, that leaves 230 mW (530 mW – 300 mW) for the

drivers. From Figures 8 and 10 (adjusted for $V_{CC} = 5.0 \text{ V}$), $V_{OL} \approx 1.38 \text{ V}$, and $V_{OH} \approx 4.27 \text{ V}$. The power dissipated in each driver is:

$$\{(5.0 - 4.27) \cdot 0.020\} + (1.38 \cdot 0.0278) = 53 \text{ mW}$$

Since each driver dissipates 53 mW, the use of all four drivers in a package would be marginal. Options include reducing the load current, reducing the ambient temperature, and/or providing a heat sink.

System Requirements

EIA-485 requires each driver to be capable of transmitting data differentially to at least 32 unit loads, plus an equivalent DC termination resistance of 60Ω, over a common mode voltage of –7.0 to 12 V. A unit load (U.L.), as defined by EIA-485, is shown in Figure 17.

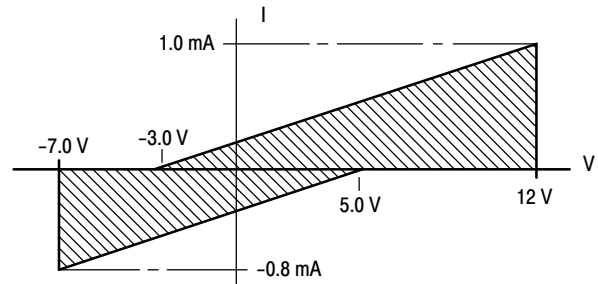

Reprinted from EIA-485, Electronic Industries Association, Washington, DC.

Figure 17. Unit Load Definition

A load current within the shaded regions represents an impedance of less than one U.L., while a load current of a magnitude outside the shaded area is greater than one U.L. A system's total load is the sum of the unit load equivalents of each receiver's input current, and each disabled driver's output leakage current. The 60Ω termination resistance mentioned above allows for two 120Ω terminating resistors.

Using the EIA-485 requirements (worst case limits), and the graphs of Figures 7 and 9, it can be determined that the maximum current an MC75172B or MC75174B driver will source or sink is ≈ 65 mA.

System Example

An example of a typical EIA-485 system is shown in Figure 18. In this example, it is assumed each receiver's input characteristics correspond to 1.0 U.L. as defined in Figure 17. Each "off" driver, with a maximum leakage of ±50 μA over the common mode range, presents a load of ≈ 0.06 U.L. The total load for the active driver is therefore 8.3 unit loads, plus the parallel combination of the two terminating resistors (60Ω). It is up to the system software to control the driver Enable pins to ensure that only one driver is active at any time.

MC75172B, MC75174B

Termination Resistors

Transmission line theory states that, in order to preserve the shape and integrity of a waveform traveling along a cable, the cable must be terminated in an impedance equal to its characteristic impedance. In a system such as that depicted in Figure 18, in which data can travel in both directions, both physical ends of the cable must be terminated. Stubs, leading to each receiver and driver, should be as short as possible.

Leaving off the terminations will generally result in reflections which can have amplitudes of several volts above V_{CC} or below ground. These overshoots and undershoots can disrupt the driver and/or receiver operation, create false data, and in some cases damage components on the bus.

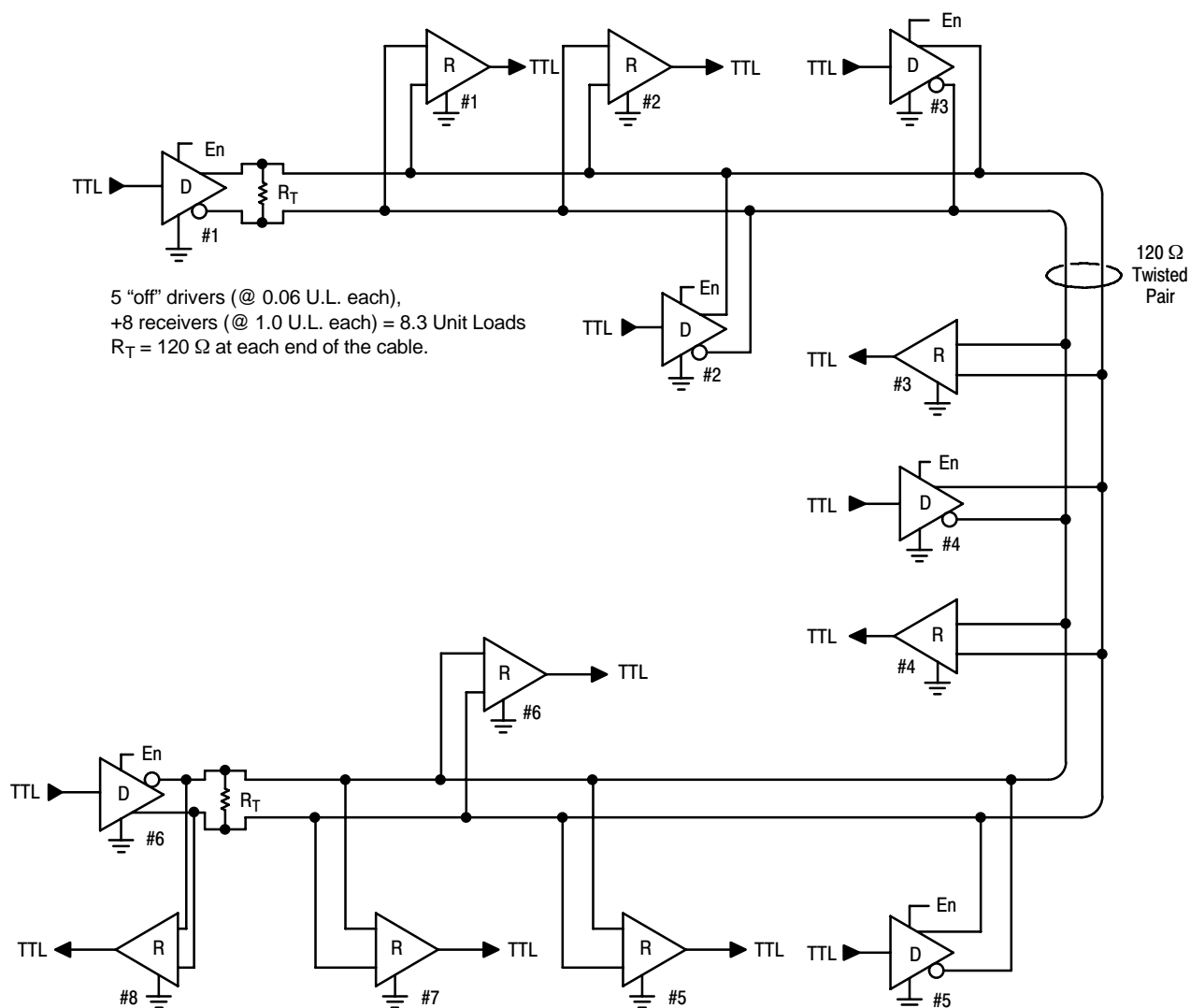

- NOTES:
1. Terminating resistors R_T must be located at the physical ends of the cable.
 2. Stubs should be as short as possible.
 3. Circuit ground of all drivers and receivers must be connected via a dedicated wire within the cable. Do not rely on chassis ground or power line ground.

Figure 18. Typical EIA-485 System

MC75172B, MC75174B

COMPARING SYSTEM REQUIREMENTS

Characteristic	Symbol	EIA-485	EIA-422-A	V.11 and X.27
GENERATOR (Driver)				
Output Impedance (Note 1)	Z_{out}	Not Specified	$< 100 \Omega$	50 10 100 Ω
Open Circuit Voltage Differential Single-Ended	V_{OCD} V_{OCS}	1.5 to 6.0 V < 6.0 V	≤ 6.0 V ≤ 6.0 V	≤ 6.0 V, w/3.9 k Ω , Load ≤ 6.0 V, w/3.9 k Ω , Load
Loaded Differential Voltage	V_{OD}	1.5 to 5.0 V, w/54 Ω load	≥ 2.0 V or $\geq 0.5 V_{OCD}$, w/100 Ω load	≥ 2.0 V or $\geq 0.5 V_{OCD}$, w/100 Ω load
Differential Voltage Balance	ΔV_{OD}	< 200 mV	≤ 400 mV	< 400 mV
Output Common Mode Range	V_{CM}	-7.0 to +12 V	Not Specified	Not Specified
Offset Voltage	V_{OS}	$-1.0 < V_{OS} < 3.0$ V	≤ 3.0 V	≤ 3.0 V
Offset Voltage Balance	ΔV_{OS}	< 200 mV	≤ 400 mV	< 400 mV
Short Circuit Current	I_{OS}	≤ 250 mA for -7.0 to 12 V	≤ 150 mA to ground	≤ 150 mA to ground
Leakage Current ($V_{CC} = 0$)	I_{OLK}	Not Specified	$\leq 100 \mu$ A to -0.25 V thru 6.0 V	$\leq 100 \mu$ A to ± 0.25 V
Output Rise/Fall Time (Note 2)	t_r, t_f	$\leq 0.3 T_B$, w/54 Ω /1150 pF load	$\leq 0.1 T_B$ or ≤ 20 ns, w/100 Ω load	$\leq 0.1 T_B$ or ≤ 20 ns, w/100 Ω load

RECEIVER

Input Sensitivity	V_{th}	± 200 mV	± 200 mV	± 300 mV
Input Bias Voltage	V_{bias}	≤ 3.0 V	≤ 3.0 V	≤ 3.0 V
Input Common Mode Range	V_{cm}	-7.0 to 12 V	-7.0 to 7.0 V	-7.0 to 7.0 V
Dynamic Input Impedance	R_{in}	Spec number of U.L.	≥ 4 k Ω	≥ 4 k Ω

NOTES: 1. Compliance with V.11 and X.27 (Blue book) output impedance requires external resistors in series with the outputs of the MC75172B and MC75174B.

2. T_B = Bit time.

Additional Information

Copies of the EIA Recommendations (EIA-485 and EIA-422-A) can be obtained from the Electronics Industries Association, Washington, D.C. (202-457-4966). Copies of the CCITT Recommendations (V.11 and X.27) can be obtained from the United States Department of Commerce, Springfield, VA (703-487-4600).

ORDERING INFORMATION

Device	Operating Temperature Range	Package	Shipping†
MC75172BDW	$T_A = -40^\circ$ to $+85^\circ$ C	SOIC-20WB	38 Units / Rail
MC75172BDWG		SOIC-20WB (Pb-Free)	
MC75172BDWR2		SOIC-20WB	1000 / Tape & Reel
MC75172BDWR2G		SOIC-20WB (Pb-Free)	
MC75174BDW		SOIC-20WB	38 Units / Rail
MC75174BDWG		SOIC-20WB (Pb-Free)	
MC75174BDWR2		SOIC-20WB	1000 / Tape & Reel
MC75174BDWR2G		SOIC-20WB (Pb-Free)	
MC75174BP		PDIP-16	25 Units / Rail
MC75174BPG		PDIP-16 (Pb-Free)	

†For information on tape and reel specifications, including part orientation and tape sizes, please refer to our Tape and Reel Packaging Specifications Brochure, BRD8011/D.

MECHANICAL CASE OUTLINE

PACKAGE DIMENSIONS

ON Semiconductor®

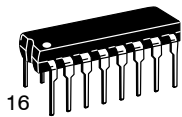

SCALE 1:1

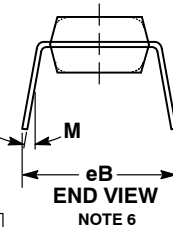
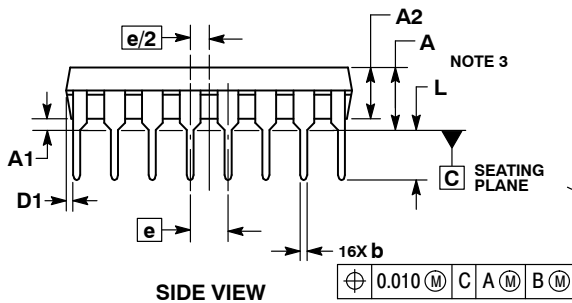
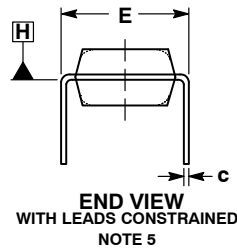
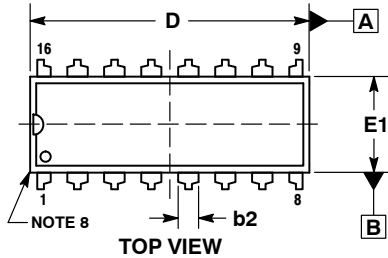

NOTE 6

DATE 22 APR 2015

NOTES:

1. DIMENSIONING AND TOLERANCING PER ASME Y14.5M, 1994.
2. CONTROLLING DIMENSION: INCHES.
3. DIMENSIONS A, A1 AND L ARE MEASURED WITH THE PACKAGE SEATED IN JEDEC SEATING PLANE GAUGE GS-3.
4. DIMENSIONS D, D1 AND E1 DO NOT INCLUDE MOLD FLASH OR PROTRUSIONS. MOLD FLASH OR PROTRUSIONS ARE NOT TO EXCEED 0.10 INCH.
5. DIMENSION E IS MEASURED AT A POINT 0.015 BELOW DATUM PLANE H WITH THE LEADS CONSTRAINED PERPENDICULAR TO DATUM C.
6. DIMENSION eB IS MEASURED AT THE LEAD TIPS WITH THE LEADS UNCONSTRAINED.
7. DATUM PLANE H IS COINCIDENT WITH THE BOTTOM OF THE LEADS, WHERE THE LEADS EXIT THE BODY.
8. PACKAGE CONTOUR IS OPTIONAL (ROUNDED OR SQUARE CORNERS).

DIM	INCHES		MILLIMETERS	
	MIN	MAX	MIN	MAX
A	---	0.210	---	5.33
A1	0.015	---	0.38	---
A2	0.115	0.195	2.92	4.95
b	0.014	0.022	0.35	0.56
b2	0.060 TYP		1.52 TYP	
C	0.008	0.014	0.20	0.36
D	0.735	0.775	18.67	19.69
D1	0.005	---	0.13	---
E	0.300	0.325	7.62	8.26
E1	0.240	0.280	6.10	7.11
e	0.100 BSC 2.54 BSC			
eB	---	0.430	---	10.92
L	0.115	0.150	2.92	3.81
M	---	10°	---	10°

GENERIC MARKING DIAGRAM*

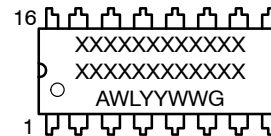

- XXXXX = Specific Device Code
- A = Assembly Location
- WL = Wafer Lot
- YY = Year
- WW = Work Week
- G = Pb-Free Package

*This information is generic. Please refer to device data sheet for actual part marking. Pb-Free indicator, "G" or microdot "▪", may or may not be present.

STYLE 1:

- PIN 1. CATHODE
- 2. CATHODE
- 3. CATHODE
- 4. CATHODE
- 5. CATHODE
- 6. CATHODE
- 7. CATHODE
- 8. CATHODE
- 9. ANODE
- 10. ANODE
- 11. ANODE
- 12. ANODE
- 13. ANODE
- 14. ANODE
- 15. ANODE
- 16. ANODE

STYLE 2:

- PIN 1. COMMON DRAIN
- 2. COMMON DRAIN
- 3. COMMON DRAIN
- 4. COMMON DRAIN
- 5. COMMON DRAIN
- 6. COMMON DRAIN
- 7. COMMON DRAIN
- 8. COMMON DRAIN
- 9. GATE
- 10. SOURCE
- 11. GATE
- 12. SOURCE
- 13. GATE
- 14. SOURCE
- 15. GATE
- 16. SOURCE

DOCUMENT NUMBER:	98ASB42431B	Electronic versions are uncontrolled except when accessed directly from the Document Repository. Printed versions are uncontrolled except when stamped "CONTROLLED COPY" in red.
DESCRIPTION:	PDIP-16	PAGE 1 OF 1

ON Semiconductor and ON are trademarks of Semiconductor Components Industries, LLC dba ON Semiconductor or its subsidiaries in the United States and/or other countries. ON Semiconductor reserves the right to make changes without further notice to any products herein. ON Semiconductor makes no warranty, representation or guarantee regarding the suitability of its products for any particular purpose, nor does ON Semiconductor assume any liability arising out of the application or use of any product or circuit, and specifically disclaims any and all liability, including without limitation special, consequential or incidental damages. ON Semiconductor does not convey any license under its patent rights nor the rights of others.

MECHANICAL CASE OUTLINE PACKAGE DIMENSIONS

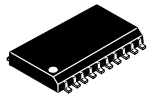

SCALE 1:1

SOIC-20 WB
CASE 751D-05
ISSUE H

DATE 22 APR 2015



NOTES:

1. DIMENSIONS ARE IN MILLIMETERS.
2. INTERPRET DIMENSIONS AND TOLERANCES PER ASME Y14.5M, 1994.
3. DIMENSIONS D AND E DO NOT INCLUDE MOLD PROTRUSION.
4. MAXIMUM MOLD PROTRUSION 0.15 PER SIDE.
5. DIMENSION B DOES NOT INCLUDE DAMBAR PROTRUSION. ALLOWABLE PROTRUSION SHALL BE 0.13 TOTAL IN EXCESS OF B DIMENSION AT MAXIMUM MATERIAL CONDITION.

DIM	MILLIMETERS	
	MIN	MAX
A	2.35	2.65
A1	0.10	0.25
b	0.35	0.49
c	0.23	0.32
D	12.65	12.95
E	7.40	7.60
e	1.27 BSC	
H	10.05	10.55
h	0.25	0.75
L	0.50	0.90
θ	0°	7°

RECOMMENDED
SOLDERING FOOTPRINT*



DIMENSIONS: MILLIMETERS

*For additional information on our Pb-Free strategy and soldering details, please download the ON Semiconductor Soldering and Mounting Techniques Reference Manual, SOLDERRM/D.

GENERIC
MARKING DIAGRAM*

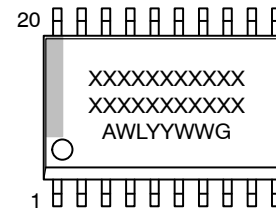

- XXXXXX = Specific Device Code
- A = Assembly Location
- WL = Wafer Lot
- YY = Year
- WW = Work Week
- G = Pb-Free Package

*This information is generic. Please refer to device data sheet for actual part marking. Pb-Free indicator, "G" or microdot "▪", may or may not be present. Some products may not follow the Generic Marking.

DOCUMENT NUMBER:	98ASB42343B	Electronic versions are uncontrolled except when accessed directly from the Document Repository. Printed versions are uncontrolled except when stamped "CONTROLLED COPY" in red.
DESCRIPTION:	SOIC-20 WB	PAGE 1 OF 1

onsemi and ONsemi are trademarks of Semiconductor Components Industries, LLC dba onsemi or its subsidiaries in the United States and/or other countries. onsemi reserves the right to make changes without further notice to any products herein. onsemi makes no warranty, representation or guarantee regarding the suitability of its products for any particular purpose, nor does onsemi assume any liability arising out of the application or use of any product or circuit, and specifically disclaims any and all liability, including without limitation special, consequential or incidental damages. onsemi does not convey any license under its patent rights nor the rights of others.

onsemi, **Onsemi**, and other names, marks, and brands are registered and/or common law trademarks of Semiconductor Components Industries, LLC dba "**onsemi**" or its affiliates and/or subsidiaries in the United States and/or other countries. **onsemi** owns the rights to a number of patents, trademarks, copyrights, trade secrets, and other intellectual property. A listing of **onsemi**'s product/patent coverage may be accessed at www.onsemi.com/site/pdf/Patent-Marking.pdf. **onsemi** reserves the right to make changes at any time to any products or information herein, without notice. The information herein is provided "as-is" and **onsemi** makes no warranty, representation or guarantee regarding the accuracy of the information, product features, availability, functionality, or suitability of its products for any particular purpose, nor does **onsemi** assume any liability arising out of the application or use of any product or circuit, and specifically disclaims any and all liability, including without limitation special, consequential or incidental damages. Buyer is responsible for its products and applications using **onsemi** products, including compliance with all laws, regulations and safety requirements or standards, regardless of any support or applications information provided by **onsemi**. "Typical" parameters which may be provided in **onsemi** data sheets and/or specifications can and do vary in different applications and actual performance may vary over time. All operating parameters, including "Typicals" must be validated for each customer application by customer's technical experts. **onsemi** does not convey any license under any of its intellectual property rights nor the rights of others. **onsemi** products are not designed, intended, or authorized for use as a critical component in life support systems or any FDA Class 3 medical devices or medical devices with a same or similar classification in a foreign jurisdiction or any devices intended for implantation in the human body. Should Buyer purchase or use **onsemi** products for any such unintended or unauthorized application, Buyer shall indemnify and hold **onsemi** and its officers, employees, subsidiaries, affiliates, and distributors harmless against all claims, costs, damages, and expenses, and reasonable attorney fees arising out of, directly or indirectly, any claim of personal injury or death associated with such unintended or unauthorized use, even if such claim alleges that **onsemi** was negligent regarding the design or manufacture of the part. **onsemi** is an Equal Opportunity/Affirmative Action Employer. This literature is subject to all applicable copyright laws and is not for resale in any manner.

PUBLICATION ORDERING INFORMATION

LITERATURE FULFILLMENT:

Email Requests to: orderlit@onsemi.com

onsemi Website: www.onsemi.com

TECHNICAL SUPPORT

North American Technical Support:

Voice Mail: 1 800-282-9855 Toll Free USA/Canada

Phone: 011 421 33 790 2910

Europe, Middle East and Africa Technical Support:

Phone: 00421 33 790 2910

For additional information, please contact your local Sales Representative