

MC74VHC126

Quad Bus Buffer with 3-State Control Inputs

The MC74VHC126 is a high speed CMOS quad bus buffer fabricated with silicon gate CMOS technology. It achieves noninverting high speed operation similar to equivalent Bipolar Schottky TTL while maintaining CMOS low power dissipation.

The MC74VHC126 requires the 3-state control input (OE) to be set Low to place the output into high impedance.

The internal circuit is composed of three stages, including a buffer output which provides high noise immunity and stable output. The inputs tolerate voltages up to 7.0 V, allowing the interface of 5.0 V systems to 3.0 V systems.

- High Speed: $t_{PD} = 3.8$ ns (Typ) at $V_{CC} = 5.0$ V
- Low Power Dissipation: $I_{CC} = 4.0$ μ A (Max) at $T_A = 25^\circ$ C
- High Noise Immunity: $V_{NIH} = V_{NIL} = 28\%$ V_{CC}
- Power Down Protection Provided on Inputs
- Balanced Propagation Delays
- Designed for 2.0 V to 5.5 V Operating Range
- Low Noise: $V_{OLP} = 0.8$ V (Max)
- Pin and Function Compatible with Other Standard Logic Families
- Latchup Performance Exceeds 300 mA
- ESD Performance: HBM > 2000 V; Machine Model > 200 V
- Chip Complexity: 72 FETs or 18 Equivalent Gates
- **These devices are available in Pb-free package(s). Specifications herein apply to both standard and Pb-free devices. Please see our website at www.onsemi.com for specific Pb-free orderable part numbers, or contact your local ON Semiconductor sales office or representative.**



ON Semiconductor[®]

<http://onsemi.com>

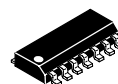

14-LEAD SOIC
D SUFFIX
CASE 751A

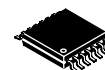

14-LEAD TSSOP
DT SUFFIX
CASE 948G



14-LEAD SOIC EIAJ
M SUFFIX
CASE 965

PIN CONNECTIONS

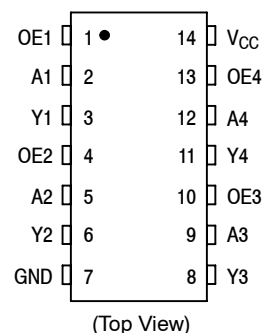

ORDERING INFORMATION

Device	Package	Shipping
MC74VHC126D	SOIC	55 Units/Rail
MC74VHC126DT	TSSOP	96 Units/Rail
MC74VHC126M	SOIC EIAJ	50 Units/Rail

DEVICE MARKING INFORMATION

See general marking information in the device marking section on page 7 of this data sheet.

MC74VHC126

Active-High Output Enables

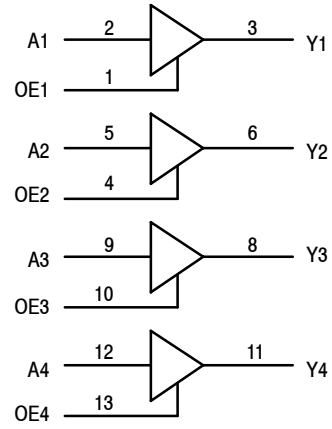

FUNCTION TABLE

VHC126		
Inputs		Output
A	OE	Y
H	H	H
L	H	L
X	L	Z

Figure 1. Logic Diagram

MC74VHC126

MAXIMUM RATINGS (Note 1)

Symbol	Parameter	Value	Unit	
V_{CC}	DC Supply Voltage	-0.5 to +7.0	V	
V_{in}	DC Input Voltage	-0.5 to +7.0	V	
V_{out}	DC Output Voltage	-0.5 to $V_{CC} + 0.5$	V	
I_{IK}	Input Diode Current	-20	mA	
I_{OK}	Output Diode Current	± 20	mA	
I_{out}	DC Output Current, per Pin	± 25	mA	
I_{CC}	DC Supply Current, V_{CC} and GND Pins	± 50	mA	
P_D	Power Dissipation in Still Air (Note 2)	SOIC Packages TSSOP Package	500 450	mW
T_{stg}	Storage Temperature	-65 to +150	$^{\circ}C$	

- Maximum Ratings are those values beyond which damage to the device may occur. Exposure to these conditions or conditions beyond those indicated may adversely affect device reliability. Functional operation under absolute maximum-rated conditions is not implied. Functional operation should be restricted to the Recommended Operating Conditions.
- Derating - SOIC Packages: - 7.0 mW/ $^{\circ}C$ from 65 $^{\circ}$ to 125 $^{\circ}C$
TSSOP Package: - 6.1 mW/ $^{\circ}C$ from 65 $^{\circ}$ to 125 $^{\circ}C$

RECOMMENDED OPERATING CONDITIONS

Symbol	Parameter	Min	Max	Unit
V_{CC}	DC Supply Voltage	2.0	5.5	V
V_{in}	DC Input Voltage	0	5.5	V
V_{out}	DC Output Voltage	0	V_{CC}	V
T_A	Operating Temperature, All Package Types	-55	+125	$^{\circ}C$
t_r, t_f	Input Rise and Fall Time	$V_{CC} = 3.3 V \pm 0.3 V$ $V_{CC} = 5.0 V \pm 0.5 V$	0 100	ns/V
		0	20	

MC74VHC126

DC ELECTRICAL CHARACTERISTICS

Symbol	Parameter	Test Conditions	V _{CC} (V)	T _A = 25°C			T _A ≤ 85°C		T _A ≤ 125°C		Unit
				Min	Typ	Max	Min	Max	Min	Max	
V _{IH}	Minimum High-Level Input Voltage		2.0	1.5			1.5		1.5		V
			3.0	2.1			2.1		2.1		
			4.5	3.15			3.15		3.15		
			5.5	3.85			3.85		3.85		
V _{IL}	Maximum Low-Level Input Voltage		2.0			0.5		0.5		0.5	V
			3.0			0.9		0.9		0.9	
			4.5			1.35		1.35		1.35	
			5.5			1.65		1.65		1.65	
V _{OH}	Minimum High-Level Output Voltage V _{IN} = V _{IH} or V _{IL}	V _{IN} = V _{IH} or V _{IL} I _{OH} = -50 μA	2.0	1.9	2.0		1.9		1.9		V
			3.0	2.9	3.0		2.9		2.9		
		4.5	4.4	4.5		4.4		4.4		4.4	
		3.0	2.58			2.48		2.34			V
4.5	3.94			3.80		3.66					
V _{OL}	Maximum Low-Level Output Voltage V _{IN} = V _{IH} or V _{IL}	V _{IN} = V _{IH} or V _{IL} I _{OL} = 50 μA	2.0		0.0	0.1		0.1		0.1	V
			3.0		0.0	0.1		0.1		0.1	
		4.5		0.0	0.1		0.1		0.1		
		3.0			0.36		0.44		0.52		V
4.5			0.36		0.44		0.52				
I _{OZ}	Maximum 3-State Leakage Current	V _{IN} = V _{IH} or V _{IL} V _{OUT} = V _{CC} or GND	5.5			±0.25		±2.5		±2.5	μA
I _{IN}	Maximum Input Leakage Current	V _{IN} = 5.5 V or GND	0 to 5.5			±0.1		±1.0		±1.0	μA
I _{CC}	Maximum Quiescent Supply Current	V _{IN} = V _{CC} or GND	5.5			4.0		40		40	μA

MC74VHC126

AC ELECTRICAL CHARACTERISTICS (Input $t_r = t_f = 3.0$ ns)

Symbol	Parameter	Test Conditions	$T_A = 25^\circ\text{C}$			$T_A = \leq 85^\circ\text{C}$		$T_A = \leq 125^\circ\text{C}$		Unit
			Min	Typ	Max	Min	Max	Min	Max	
t_{PLH} , t_{PHL}	Maximum Propagation Delay, A to Y	$V_{CC} = 3.3 \pm 0.3$ V $C_L = 15$ pF		5.6	8.0	1.0	9.5	1.0	12.0	ns
		$C_L = 50$ pF		8.1	11.5	1.0	13.0	1.0	15.0	
		$V_{CC} = 5.0 \pm 0.5$ V $C_L = 15$ pF		3.8	5.5	1.0	6.5	1.0	8.5	
		$C_L = 50$ pF		5.3	7.5	1.0	8.5	1.0	10.5	
t_{PZL} , t_{PZH}	Maximum Output Enable Time, OE to Y	$V_{CC} = 3.3 \pm 0.3$ V $C_L = 15$ pF		5.4	8.0	1.0	9.5	1.0	11.5	ns
		$R_L = 1.0$ k Ω $C_L = 50$ pF		7.9	11.5	1.0	13.0	1.0	15.0	
		$V_{CC} = 5.0 \pm 0.5$ V $C_L = 15$ pF		3.6	5.1	1.0	6.0	1.0	7.5	
		$R_L = 1.0$ k Ω $C_L = 50$ pF		5.1	7.1	1.0	8.0	1.0	9.5	
t_{PLZ} , t_{PHZ}	Maximum Output Disable Time, OE to Y	$V_{CC} = 3.3 \pm 0.3$ V $C_L = 50$ pF		9.5	13.2	1.0	15.0	1.0	18.0	ns
		$R_L = 1.0$ k Ω								
		$V_{CC} = 5.0 \pm 0.5$ V $C_L = 50$ pF		6.1	8.8	1.0	10.0	1.0	12.0	
		$R_L = 1.0$ k Ω								
t_{OSLH} , t_{OSHL}	Output-to-Output Skew	$V_{CC} = 3.3 \pm 0.3$ V $C_L = 50$ pF (Note 3)			1.5		1.5		1.5	ns
		$V_{CC} = 5.0 \pm 0.5$ V $C_L = 50$ pF (Note 3)			1.0		1.0		1.0	
C_{in}	Maximum Input Capacitance			4.0	10		10		10	pF
C_{out}	Maximum Three-State Output Capacitance (Output in High Impedance State)			6.0						pF

C_{PD}	Power Dissipation Capacitance (Note 4)	Typical @ 25°C, $V_{CC} = 5.0$ V		pF
		15		

3. Parameter guaranteed by design. $t_{OSLH} = |t_{PLHm} - t_{PLHn}|$, $t_{OSHL} = |t_{PHLm} - t_{PHLn}|$.

4. C_{PD} is defined as the value of the internal equivalent capacitance which is calculated from the operating current consumption without load. Average operating current can be obtained by the equation: $I_{CC(OPR)} = C_{PD} \cdot V_{CC} \cdot f_{in} + I_{CC}/4$ (per buffer). C_{PD} is used to determine the no-load dynamic power consumption; $P_D = C_{PD} \cdot V_{CC}^2 \cdot f_{in} + I_{CC} \cdot V_{CC}$.

NOISE CHARACTERISTICS (Input $t_r = t_f = 3.0$ ns, $C_L = 50$ pF, $V_{CC} = 5.0$ V)

Symbol	Characteristic	$T_A = 25^\circ\text{C}$		Unit
		Typ	Max	
V_{OLP}	Quiet Output Maximum Dynamic V_{OL}	0.3	0.8	V
V_{OLV}	Quiet Output Minimum Dynamic V_{OL}	- 0.3	- 0.8	V
V_{IHD}	Minimum High Level Dynamic Input Voltage		3.5	V
V_{ILD}	Maximum Low Level Dynamic Input Voltage		1.5	V

MC74VHC126

SWITCHING WAVEFORMS

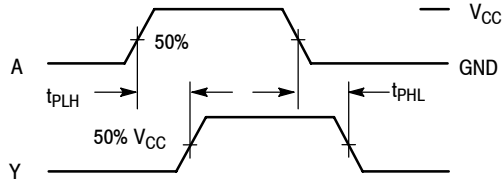

Figure 2.

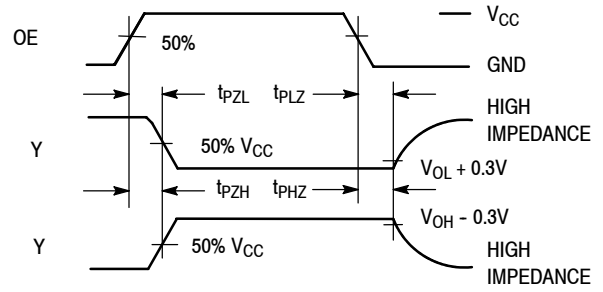
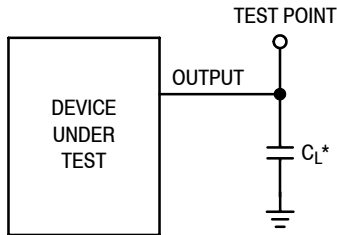
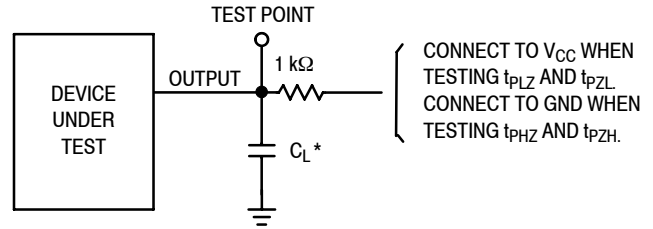

Figure 3.



*Includes all probe and jig capacitance

Figure 4. Test Circuit



*Includes all probe and jig capacitance

Figure 5. Test Circuit

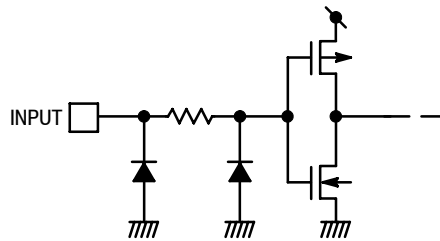
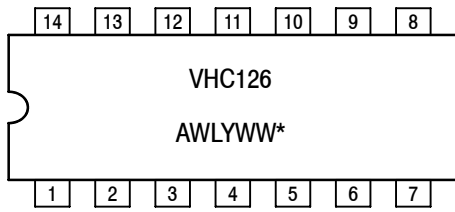

Figure 6. Input Equivalent Circuit

MC74VHC126

MARKING DIAGRAMS



**14-LEAD SOIC
D SUFFIX
CASE 751A**

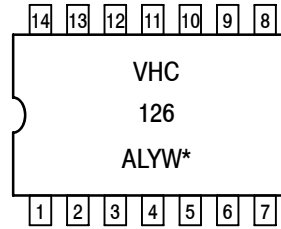

**14-LEAD TSSOP
DT SUFFIX
CASE 948G**

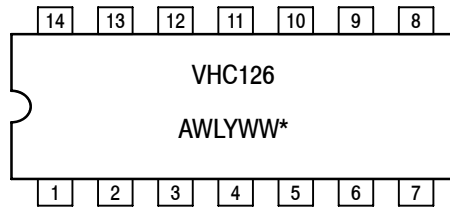

**14-LEAD SOIC EIAJ
M SUFFIX
CASE 965**

*See Applications Note #AND8004/D for date code and traceability information.

MC74VHC126

PACKAGE DIMENSIONS

D SUFFIX SOIC-14 CASE 751A-03 ISSUE F

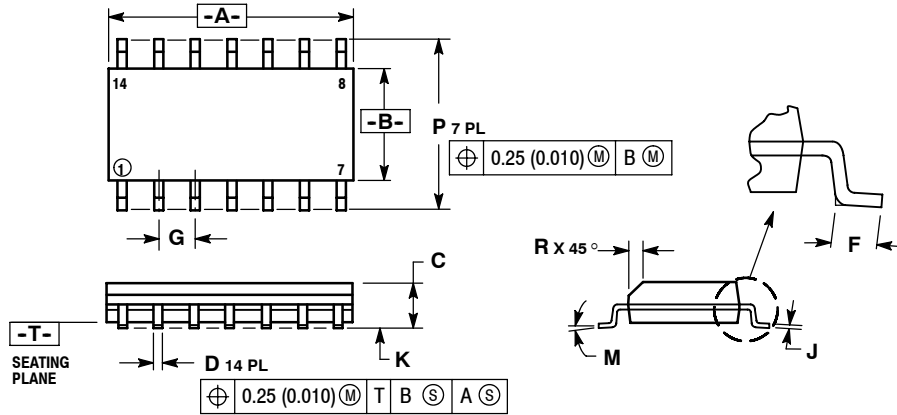

NOTES:

1. DIMENSIONING AND TOLERANCING PER ANSI Y14.5M, 1982.
2. CONTROLLING DIMENSION: MILLIMETER.
3. DIMENSIONS A AND B DO NOT INCLUDE MOLD PROTRUSION.
4. MAXIMUM MOLD PROTRUSION 0.15 (0.006) PER SIDE.
5. DIMENSION D DOES NOT INCLUDE DAMBAR PROTRUSION. ALLOWABLE DAMBAR PROTRUSION SHALL BE 0.127 (0.005) TOTAL IN EXCESS OF THE D DIMENSION AT MAXIMUM MATERIAL CONDITION.

DIM	MILLIMETERS		INCHES	
	MIN	MAX	MIN	MAX
A	8.55	8.75	0.337	0.344
B	3.80	4.00	0.150	0.157
C	1.35	1.75	0.054	0.068
D	0.35	0.49	0.014	0.019
F	0.40	1.25	0.016	0.049
G	1.27 BSC		0.050 BSC	
J	0.19	0.25	0.008	0.009
K	0.10	0.25	0.004	0.009
M	0°	7°	0°	7°
P	5.80	6.20	0.228	0.244
R	0.25	0.50	0.010	0.019

DT SUFFIX TSSOP CASE 948G-01 ISSUE O

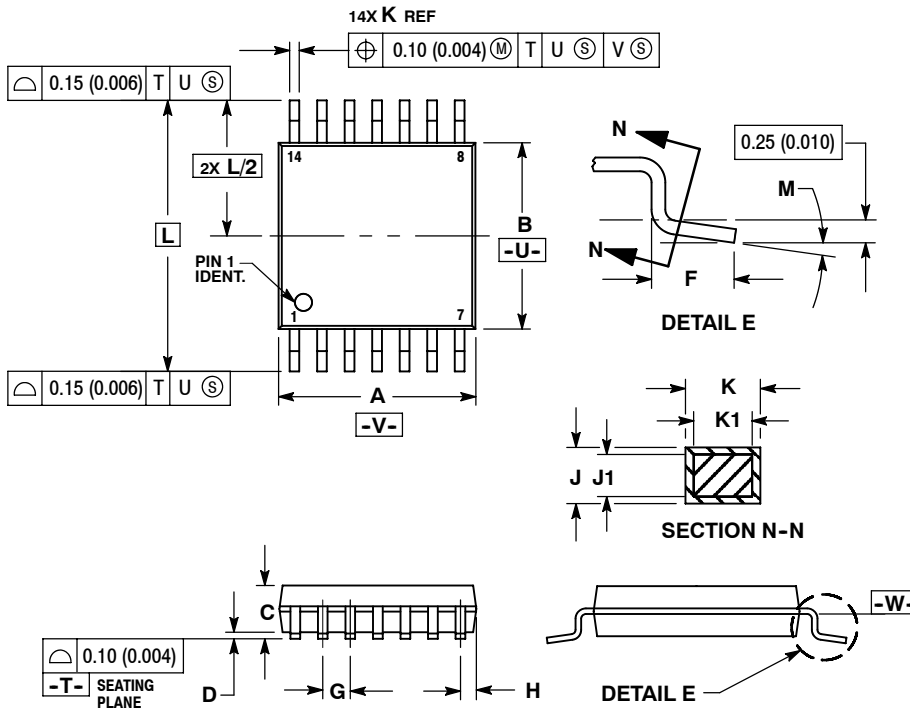

NOTES:

1. DIMENSIONING AND TOLERANCING PER ANSI Y14.5M, 1982.
2. CONTROLLING DIMENSION: MILLIMETER.
3. DIMENSION A DOES NOT INCLUDE MOLD FLASH, PROTRUSIONS OR GATE BURRS. MOLD FLASH OR GATE BURRS SHALL NOT EXCEED 0.15 (0.006) PER SIDE.
4. DIMENSION B DOES NOT INCLUDE INTERLEAD FLASH OR PROTRUSION. INTERLEAD FLASH OR PROTRUSION SHALL NOT EXCEED 0.25 (0.010) PER SIDE.
5. DIMENSION K DOES NOT INCLUDE DAMBAR PROTRUSION. ALLOWABLE DAMBAR PROTRUSION SHALL BE 0.08 (0.003) TOTAL IN EXCESS OF THE K DIMENSION AT MAXIMUM MATERIAL CONDITION.
6. TERMINAL NUMBERS ARE SHOWN FOR REFERENCE ONLY.
7. DIMENSION A AND B ARE TO BE DETERMINED AT DATUM PLANE -W-.

DIM	MILLIMETERS		INCHES	
	MIN	MAX	MIN	MAX
A	4.90	5.10	0.193	0.200
B	4.30	4.50	0.169	0.177
C	---	1.20	---	0.047
D	0.05	0.15	0.002	0.006
F	0.50	0.75	0.020	0.030
G	0.65 BSC		0.026 BSC	
H	0.50	0.60	0.020	0.024
J	0.09	0.20	0.004	0.008
J1	0.09	0.16	0.004	0.006
K	0.19	0.30	0.007	0.012
K1	0.19	0.25	0.007	0.010
L	6.40 BSC		0.252 BSC	
M	0°	8°	0°	8°

MC74VHC126

PACKAGE DIMENSIONS

M SUFFIX
SO-14
CASE 965-01
ISSUE O

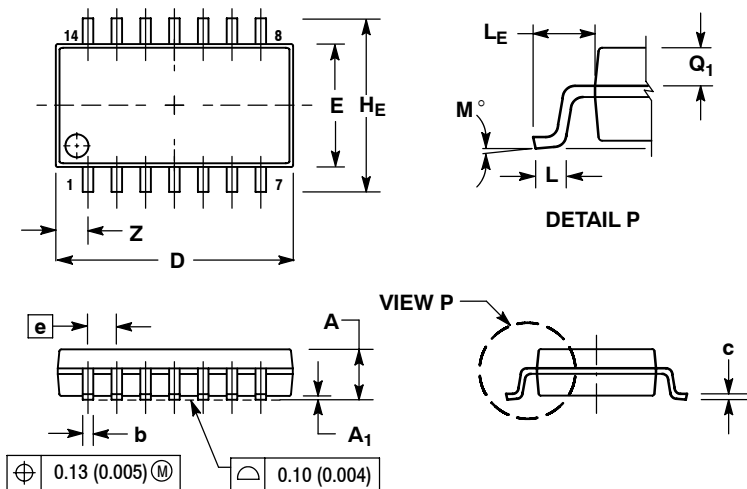

NOTES:

1. DIMENSIONING AND TOLERANCING PER ANSI Y14.5M, 1982.
2. CONTROLLING DIMENSION: MILLIMETER.
3. DIMENSIONS D AND E DO NOT INCLUDE MOLD FLASH OR PROTRUSIONS AND ARE MEASURED AT THE PARTING LINE. MOLD FLASH OR PROTRUSIONS SHALL NOT EXCEED 0.15 (0.006) PER SIDE.
4. TERMINAL NUMBERS ARE SHOWN FOR REFERENCE ONLY.
5. THE LEAD WIDTH DIMENSION (b) DOES NOT INCLUDE DAMBAR PROTRUSION. ALLOWABLE DAMBAR PROTRUSION SHALL BE 0.08 (0.003) TOTAL IN EXCESS OF THE LEAD WIDTH DIMENSION AT MAXIMUM MATERIAL CONDITION. DAMBAR CANNOT BE LOCATED ON THE LOWER RADIUS OR THE FOOT. MINIMUM SPACE BETWEEN PROTRUSIONS AND ADJACENT LEAD TO BE 0.46 (0.018).

DIM	MILLIMETERS		INCHES	
	MIN	MAX	MIN	MAX
A	---	2.05	---	0.081
A ₁	0.05	0.20	0.002	0.008
b	0.35	0.50	0.014	0.020
c	0.18	0.27	0.007	0.011
D	9.90	10.50	0.390	0.413
E	5.10	5.45	0.201	0.215
e	1.27 BSC		0.050 BSC	
HE	7.40	8.20	0.291	0.323
0.50	0.50	0.85	0.020	0.033
LE	1.10	1.50	0.043	0.059
M	0°	10°	0°	10°
Q ₁	0.70	0.90	0.028	0.035
Z	---	1.42	---	0.056

ON Semiconductor and are registered trademarks of Semiconductor Components Industries, LLC (SCILLC). SCILLC reserves the right to make changes without further notice to any products herein. SCILLC makes no warranty, representation or guarantee regarding the suitability of its products for any particular purpose, nor does SCILLC assume any liability arising out of the application or use of any product or circuit, and specifically disclaims any and all liability, including without limitation special, consequential or incidental damages. "Typical" parameters which may be provided in SCILLC data sheets and/or specifications can and do vary in different applications and actual performance may vary over time. All operating parameters, including "Typicals" must be validated for each customer application by customer's technical experts. SCILLC does not convey any license under its patent rights nor the rights of others. SCILLC products are not designed, intended, or authorized for use as components in systems intended for surgical implant into the body, or other applications intended to support or sustain life, or for any other application in which the failure of the SCILLC product could create a situation where personal injury or death may occur. Should Buyer purchase or use SCILLC products for any such unintended or unauthorized application, Buyer shall indemnify and hold SCILLC and its officers, employees, subsidiaries, affiliates, and distributors harmless against all claims, costs, damages, and expenses, and reasonable attorney fees arising out of, directly or indirectly, any claim of personal injury or death associated with such unintended or unauthorized use, even if such claim alleges that SCILLC was negligent regarding the design or manufacture of the part. SCILLC is an Equal Opportunity/Affirmative Action Employer. This literature is subject to all applicable copyright laws and is not for resale in any manner.

PUBLICATION ORDERING INFORMATION

LITERATURE FULFILLMENT:

Literature Distribution Center for ON Semiconductor
P.O. Box 61312, Phoenix, Arizona 85082-1312 USA
Phone: 480-829-7710 or 800-344-3860 Toll Free USA/Canada
Fax: 480-829-7709 or 800-344-3867 Toll Free USA/Canada
Email: orderlit@onsemi.com

N. American Technical Support: 800-282-9855 Toll Free
USA/Canada

Japan: ON Semiconductor, Japan Customer Focus Center
2-9-1 Kamimeguro, Meguro-ku, Tokyo, Japan 153-0051
Phone: 81-3-5773-3850

ON Semiconductor Website: <http://onsemi.com>

Order Literature: <http://www.onsemi.com/litorder>

For additional information, please contact your local Sales Representative.