

High temperature, rail-to-rail input/output, 8 MHz operational amplifier

Datasheet - production data

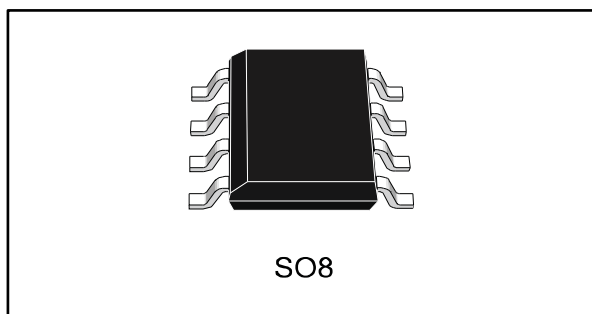

Features

- Rail-to-rail input and output
- Wide bandwidth
- Low power consumption: 820 μA typ
- Unity gain stability
- High output current: 35 mA
- Operating range from 2.5 to 5.5 V
- Low input bias current, 1 pA typ
- ESD internal protection ≥ 5 kV
- Latch-up immunity

Applications

- Automotive products

Description

The TSV912H operational amplifier offers low voltage operation and rail-to-rail input and output.

The device features an excellent speed/power consumption ratio, offering an 8 MHz gain-bandwidth product while consuming only 1.1 mA maximum at 5 V. It is unity gain stable and features an ultra-low input bias current.

The TSV912H is a high temperature version of the TSV912, and can operate from -40 °C to 150 °C with unique characteristics. Its main target applications are automotive, but the device is also ideal for sensor interfaces, battery-supplied and portable applications, as well as active filtering.

Contents

1	Package pin connections.....	3
2	Absolute maximum ratings and operating conditions	4
3	Electrical characteristics	5
4	Electrical characteristic curves	11
5	Application information	14
	5.1 Driving resistive and capacitive loads	14
	5.2 PCB layouts	14
6	Package information	15
	6.1 SO8 package information.....	16
7	Ordering information.....	17
8	Revision history	18

1 Package pin connections

Figure 1: Pin connection (top view)

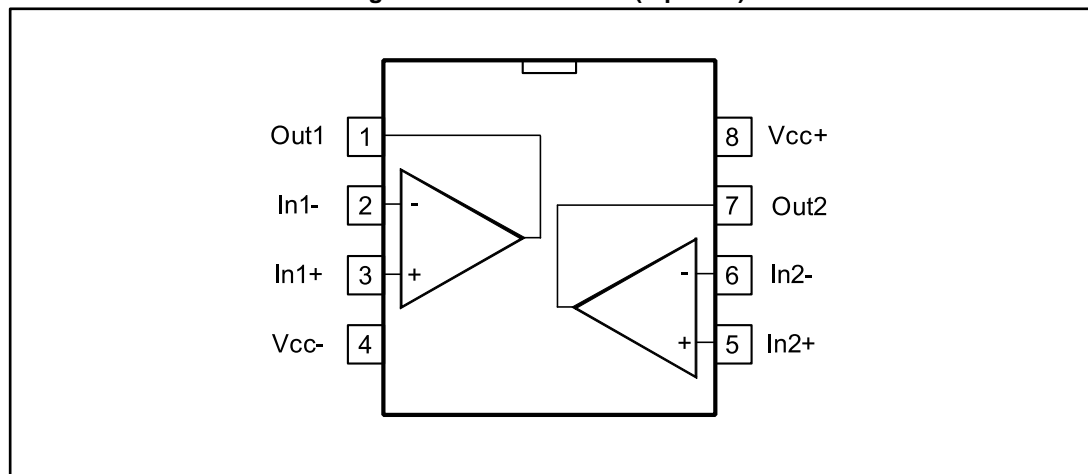

2 Absolute maximum ratings and operating conditions

Table 1: Absolute maximum ratings

Symbol	Parameter	Value	Unit
V _{CC}	Supply voltage, (V _{CC} ⁺) - (V _{CC} ⁻) ⁽¹⁾	6	V
V _{id}	Differential input voltage ⁽²⁾	±V _{CC}	
V _{in}	Input voltage ⁽³⁾	(V _{CC} ⁻) - 0.2 to (V _{CC} ⁺) + 0.2	
I _{in}	Input current ⁽⁴⁾	10	mA
T _{stg}	Storage temperature	-65 to 150	°C
T _j	Maximum junction temperature	160	
R _{thja}	Thermal resistance junction to ambient ⁽⁵⁾⁽⁶⁾	125	°C/W
R _{thjc}	Thermal resistance junction to case ⁽⁵⁾⁽⁶⁾	40	
ESD	HBM: human body model ⁽⁷⁾	5	kV
	MM: machine model ⁽⁸⁾	400	V
	CDM: charged device model ⁽⁹⁾	1500	
	Latch-up immunity	200	mA

Notes:

- ⁽¹⁾All voltage values, except the differential voltage, are with respect to the network ground terminal.
- ⁽²⁾Differential voltages are the non-inverting input terminal with respect to the inverting input terminal.
- ⁽³⁾V_{CC} - V_{in} must not exceed 6 V.
- ⁽⁴⁾Input current must be limited by a resistor in series with the inputs.
- ⁽⁵⁾R_{th} are typical values.
- ⁽⁶⁾Short-circuits can cause excessive heating and destructive dissipation.
- ⁽⁷⁾Human body model: a 100 pF capacitor is charged to the specified voltage, then discharged through a 1.5 kΩ resistor between two pins of the device. This is done for all couples of connected pin combinations while the other pins are floating.
- ⁽⁸⁾Machine model: a 200 pF capacitor is charged to the specified voltage, then discharged directly between two pins of the device with no external series resistor (internal resistor < 5 Ω). This is done for all couples of connected pin combinations while the other pins are floating.
- ⁽⁹⁾Charged device model: all pins and the package are charged together to the specified voltage and then discharged directly to the ground through only one pin. This is done for all pins.

Table 2: Operating conditions

Symbol	Parameter	Value	Unit
V _{CC}	Supply voltage (V _{CC} ⁺) - (V _{CC} ⁻)	2.5 to 5.5	V
V _{icm}	Common mode input voltage range	(V _{CC} ⁻) - 0.1 to (V _{CC} ⁺) + 0.1	
T _{oper}	Operating free-air temperature range	-40 to 150	°C

3 Electrical characteristics

Table 3: Electrical characteristics at $V_{CC+} = 2.5\text{ V}$ with $V_{CC-} = 0\text{ V}$, $V_{icm} = V_{CC}/2$, R_L connected to $V_{CC}/2$, $T = 25\text{ °C}$ (unless otherwise specified)

Symbol	Parameter	Conditions	Min.	Typ.	Max.	Unit
DC performance						
V_{io}	Input offset voltage	$T = 25\text{ °C}$		0.1	4.5	mV
		$T_{min} < T < T_{max}$			7.5	
DV_{io}/DT	Input offset voltage drift	$-40\text{ °C} < T < 125\text{ °C}$		2		$\mu\text{V}/\text{°C}$
		$125\text{ °C} < T < 150\text{ °C}$		20		
I_{io}	Input offset current	$V_{out} = V_{CC}/2$, $T = 25\text{ °C}$		1	10 ⁽¹⁾	pA
		$V_{out} = V_{CC}/2$, $T_{min} < T < T_{max}$			5	nA
I_{ib}	Input bias current	$V_{out} = V_{CC}/2$, $T = 25\text{ °C}$		1	10 ⁽¹⁾	pA
		$V_{out} = V_{CC}/2$, $T_{min} < T < T_{max}$			5	nA
CMR	Common mode rejection ratio $20 \log(\Delta V_{ic}/\Delta V_{io})$	$0\text{ V to } 2.5\text{ V}$, $V_{out} = 1.25\text{ V}$, $T = 25\text{ °C}$	58	75		dB
		$0\text{ V to } 2.5\text{ V}$, $V_{out} = 1.25\text{ V}$, $T_{min} < T < T_{max}$	53			
A_{vd}	Large signal voltage gain	$R_L = 10\text{ k}\Omega$, $V_{out} = 0.5\text{ V to } 2\text{ V}$, $T = 25\text{ °C}$	80	89		
		$R_L = 10\text{ k}\Omega$, $V_{out} = 0.5\text{ V to } 2\text{ V}$, $T_{min} < T < T_{max}$	70			
$V_{CC} - V_{OH}$	High-level output voltage	$R_L = 10\text{ k}\Omega$, $T = 25\text{ °C}$		15	40	mV
		$R_L = 10\text{ k}\Omega$, $T_{min} < T < T_{max}$			60	
		$R_L = 600\ \Omega$, $T = 25\text{ °C}$		45	150	
		$R_L = 600\ \Omega$, $T_{min} < T < T_{max}$			250	
V_{OL}	Low-level output voltage	$R_L = 10\text{ k}\Omega$, $T = 25\text{ °C}$		15	40	mV
		$R_L = 10\text{ k}\Omega$, $T_{min} < T < T_{max}$			60	
		$R_L = 600\ \Omega$, $T = 25\text{ °C}$		45	150	
		$R_L = 600\ \Omega$, $T_{min} < T < T_{max}$			250	
I_{out}	I_{sink}	$V_{out} = 2.5\text{ V}$, $T = 25\text{ °C}$	18	32		mA
		$V_{out} = 2.5\text{ V}$, $T_{min} < T < T_{max}$	14			
	I_{source}	$V_{out} = 0\text{ V}$, $T = 25\text{ °C}$	18	35		
		$V_{out} = 0\text{ V}$, $T_{min} < T < T_{max}$	14			
I_{CC}	Supply current (per operator)	No load, $V_{out} = V_{CC}/2$, $T = 25\text{ °C}$		0.78	1.1	
		No load, $V_{out} = V_{CC}/2$, $T_{min} < T < T_{max}$			1.1	
AC performance						
GBP	Gain bandwidth product	$R_L = 2\text{ k}\Omega$, $C_L = 100\text{ pF}$, $f = 100\text{ kHz}$, $T = 25\text{ °C}$		8		MHz
		$R_L = 2\text{ k}\Omega$, $C_L = 100\text{ pF}$, $f = 100\text{ kHz}$, $T_{min} < T < T_{max}$		4		
F_u	Unity gain frequency	$R_L = 2\text{ k}\Omega$, $C_L = 100\text{ pF}$		7.2		

Electrical characteristics

TSV912H

Symbol	Parameter	Conditions	Min.	Typ.	Max.	Unit
ϕ_m	Phase margin	$R_L = 2\text{ k}\Omega, C_L = 100\text{ pF}$		45		Degrees
G_m	Gain margin			8		dB
SR	Slew rate	$R_L = 2\text{ k}\Omega, C_L = 100\text{ pF}, A_v = 1, T = 25\text{ }^\circ\text{C}$		4.5		V/ μs
		$R_L = 2\text{ k}\Omega, C_L = 100\text{ pF}, A_v = 1, T_{\text{min}} < T < T_{\text{max}}$		3.5		
e_n	Equivalent input noise voltage	$f = 10\text{ kHz}$		21		nV/ $\sqrt{\text{Hz}}$
THD+ e_n	Total harmonic distortion	$G = 1, f = 1\text{ kHz}, R_L = 2\text{ k}\Omega, Bw = 22\text{ kHz}, V_{\text{icm}} = (V_{\text{CC}} + 1)/2, V_{\text{out}} = 1.1\text{ V}_{\text{pp}}$		0.001		%

Notes:

⁽¹⁾Guaranteed by design.

Table 4: Electrical characteristics at $V_{CC+} = 3.3\text{ V}$ with $V_{CC-} = 0\text{ V}$, $V_{icm} = V_{CC}/2$, R_L connected to $V_{CC}/2$, $T = 25\text{ °C}$ (unless otherwise specified)

Symbol	Parameter	Conditions	Min.	Typ.	Max.	Unit
DC performance						
V_{io}	Input offset voltage	$T = 25\text{ °C}$		0.1	4.5	mV
		$T_{min} < T < T_{max}$			7.5	
DV_{io}	Input offset voltage drift	$-40\text{ °C} < T < 125\text{ °C}$		2		$\mu\text{V}/\text{°C}$
		$125\text{ °C} < T < 150\text{ °C}$		20		
I_{io}	Input offset current	$V_{out} = V_{CC}/2$, $T = 25\text{ °C}$		1	10 ⁽¹⁾	pA
		$V_{out} = V_{CC}/2$, $T_{min} < T < T_{max}$			5	nA
I_{ib}	Input bias current	$V_{out} = V_{CC}/2$, $T = 25\text{ °C}$		1	10 ⁽¹⁾	pA
		$V_{out} = V_{CC}/2$, $T_{min} < T < T_{max}$			5	nA
CMR	Common mode rejection ratio $20 \log (\Delta V_{ic}/\Delta V_{io})$	$0\text{ V to } 3.3\text{ V}$, $V_{out} = 1.65\text{ V}$, $T = 25\text{ °C}$	60	78		dB
		$0\text{ V to } 3.3\text{ V}$, $V_{out} = 1.65\text{ V}$, $T_{min} < T < T_{max}$	55			
A_{vd}	Large signal voltage gain	$R_L = 10\text{ k}\Omega$, $V_{out} = 0.5\text{ V to } 2.8\text{ V}$, $T = 25\text{ °C}$	80	90		dB
		$R_L = 10\text{ k}\Omega$, $V_{out} = 0.5\text{ V to } 2.8\text{ V}$, $T_{min} < T < T_{max}$	70			
$V_{CC} - V_{OH}$	High-level output voltage	$R_L = 10\text{ k}\Omega$, $T = 25\text{ °C}$		15	40	mV
		$R_L = 10\text{ k}\Omega$, $T_{min} < T < T_{max}$			60	
		$R_L = 600\ \Omega$, $T = 25\text{ °C}$		45	150	
		$R_L = 600\ \Omega$, $T_{min} < T < T_{max}$			250	
V_{OL}	Low-level output voltage	$R_L = 10\text{ k}\Omega$, $T = 25\text{ °C}$		15	40	mV
		$R_L = 10\text{ k}\Omega$, $T_{min} < T < T_{max}$			60	
		$R_L = 600\ \Omega$, $T = 25\text{ °C}$		45	150	
		$R_L = 600\ \Omega$, $T_{min} < T < T_{max}$			250	
I_{out}	I_{sink}	$V_{out} = 3.3\text{ V}$, $T = 25\text{ °C}$	18	32		mA
		$V_{out} = 3.3\text{ V}$, $T_{min} < T < T_{max}$	14			
	I_{source}	$V_{out} = 0\text{ V}$, $T = 25\text{ °C}$	18	35		
		$V_{out} = 0\text{ V}$, $T_{min} < T < T_{max}$	14			
I_{CC}	Supply current (per operator)	No load, $V_{out} = V_{CC}/2$, $T = 25\text{ °C}$		0.8	1.1	
		No load, $V_{out} = V_{CC}/2$, $T_{min} < T < T_{max}$			1.1	
AC performance						
GBP	Gain bandwidth product	$R_L = 2\text{ k}\Omega$, $C_L = 100\text{ pF}$, $f = 100\text{ kHz}$, $T = 25\text{ °C}$		8		MHz
		$R_L = 2\text{ k}\Omega$, $C_L = 100\text{ pF}$, $f = 100\text{ kHz}$, $T_{min} < T < T_{max}$		4.2		
F_u	Unity gain frequency			7.2		
ϕ_m	Phase margin	$R_L = 2\text{ k}\Omega$, $C_L = 100\text{ pF}$		45		Degrees
G_m	Gain margin			8		dB

Electrical characteristics

TSV912H

Symbol	Parameter	Conditions	Min.	Typ.	Max.	Unit
SR	Slew rate	$R_L = 2 \text{ k}\Omega$, $C_L = 100 \text{ pF}$, $A_v = 1$, $T = 25 \text{ }^\circ\text{C}$		4.5		V/ μs
		$R_L = 2 \text{ k}\Omega$, $C_L = 100 \text{ pF}$, $A_v = 1$, $T_{\text{min}} < T < T_{\text{max}}$		3.5		
e_n	Equivalent input noise voltage	$f = 10 \text{ kHz}$		21		nV/ $\sqrt{\text{Hz}}$
THD+ e_n	Total harmonic distortion	$G = 1$, $f = 1 \text{ kHz}$, $R_L = 2 \text{ k}\Omega$, $B_w = 22 \text{ kHz}$, $V_{\text{icm}} = (V_{\text{CC}} + 1)/2$, $V_{\text{out}} = 1.9 V_{\text{pp}}$		0.0007		%

Notes:⁽¹⁾Guaranteed by design.

Table 5: Electrical characteristics at VCC+ = 5 V with VCC- = 0 V, Vicm = VCC/2, RL connected to VCC/2, full temperature range (unless otherwise specified)

Symbol	Parameter	Conditions	Min.	Typ.	Max.	Unit
DC performance						
V _{io}	Input offset voltage	T = 25 °C		0.1	4.5	mV
		T _{min} < T < T _{max}			7.5	
DV _{io}	Input offset voltage drift	-40 °C < T < 125 °C		2		μV/°C
		125 °C < T < 150 °C		20		
I _{io}	Input offset current	V _{out} = V _{CC} /2, T = 25 °C		1	10 ⁽¹⁾	pA
		V _{out} = V _{CC} /2, T _{min} < T < T _{max}			5	nA
I _{ib}	Input bias current	V _{out} = V _{CC} /2, T = 25 °C		1	10 ⁽¹⁾	pA
		V _{out} = V _{CC} /2, T _{min} < T < T _{max}			5	nA
CMR	Common mode rejection ratio 20 log (ΔV _{ic} /ΔV _{io})	0 V to 5 V, V _{out} = 2.5 V, T = 25 °C	62	82		dB
		0 V to 5 V, V _{out} = 2.5 V, T _{min} < T < T _{max}	58			
SVR	Supply voltage rejection ratio 20 log (ΔV _{CC} /ΔV _{io})	V _{CC} = 2.5 to 5 V, T = 25 °C	70	86		dB
		V _{CC} = 2.5 to 5 V, T _{min} < T < T _{max}	65			
A _{vd}	Large signal voltage gain	R _L = 10 kΩ, V _{out} = 0.5 V to 4.5 V, T = 25 °C	80	91		dB
		R _L = 10 kΩ, V _{out} = 0.5 V to 4.5 V, T _{min} < T < T _{max}	70			
V _{CC} - V _{OH}	High-level output voltage	R _L = 10 kΩ, T = 25 °C		15	40	mV
		R _L = 10 kΩ, T _{min} < T < T _{max}			60	
		R _L = 600 Ω, T = 25 °C		45	150	
		R _L = 600 Ω, T _{min} < T < T _{max}			250	
V _{OL}	Low-level output voltage	R _L = 10 kΩ, T = 25 °C		15	40	mV
		R _L = 10 kΩ, T _{min} < T < T _{max}			60	
		R _L = 600 Ω, T = 25 °C		45	150	
		R _L = 600 Ω, T _{min} < T < T _{max}			250	
I _{out}	I _{sink}	V _{out} = 5 V, T = 25 °C	18	32		mA
		V _{out} = 5 V, T _{min} < T < T _{max}	14			
	I _{source}	V _{out} = 0 V, T = 25 °C	18	35		
		V _{out} = 0 V, T _{min} < T < T _{max}	14			
I _{CC}	Supply current (per operator)	No load, V _{out} = 2.5 V, T = 25 °C		0.82	1.1	mA
		No load, V _{out} = 2.5 V, T _{min} < T < T _{max}			1.1	
AC performance						
GBP	Gain bandwidth product	R _L = 2 kΩ, C _L = 100 pF, f = 100 kHz, T = 25 °C		8		MHz
		R _L = 2 kΩ, C _L = 100 pF, f = 100 kHz, T _{min} < T < T _{max}		4.5		
F _u	Unity gain frequency	R _L = 2 kΩ, C _L = 100 pF		7.5		

Electrical characteristics

TSV912H

Symbol	Parameter	Conditions	Min.	Typ.	Max.	Unit
ϕ_m	Phase margin	$R_L = 2\text{ k}\Omega, C_L = 100\text{ pF}$		45		Degrees
G_m	Gain margin			8		dB
SR	Slew rate	$R_L = 2\text{ k}\Omega, C_L = 100\text{ pF}, A_v = 1, T = 25\text{ }^\circ\text{C}$		4.5		V/ μs
		$R_L = 2\text{ k}\Omega, C_L = 100\text{ pF}, A_v = 1, T_{\text{min}} < T < T_{\text{max}}$		3.5		
e_n	Equivalent input noise voltage	$f = 1\text{ kHz}$		27		nV/ $\sqrt{\text{Hz}}$
		$f = 10\text{ kHz}$		21		
THD+ e_n	Total harmonic distortion	$G = 1, f = 1\text{ kHz}, R_L = 2\text{ k}\Omega, \text{Bw} = 22\text{ kHz}, V_{\text{icm}} = (V_{\text{CC}} + 1)/2, V_{\text{out}} = 3.6\text{ V}_{\text{pp}}$		0.0004		%

Notes:

⁽¹⁾Guaranteed by design.

4 Electrical characteristic curves

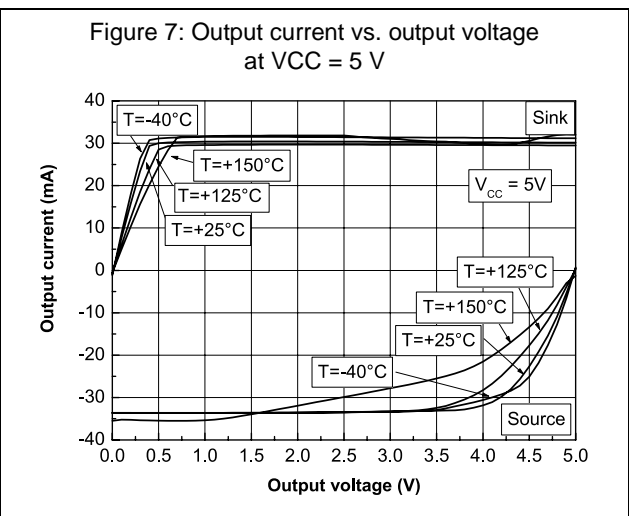
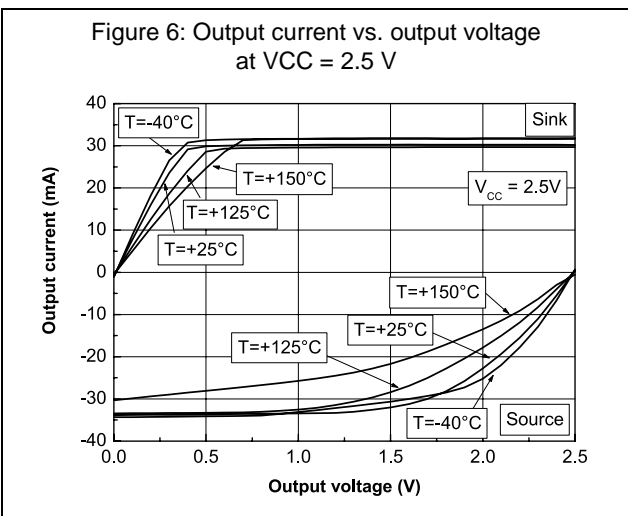
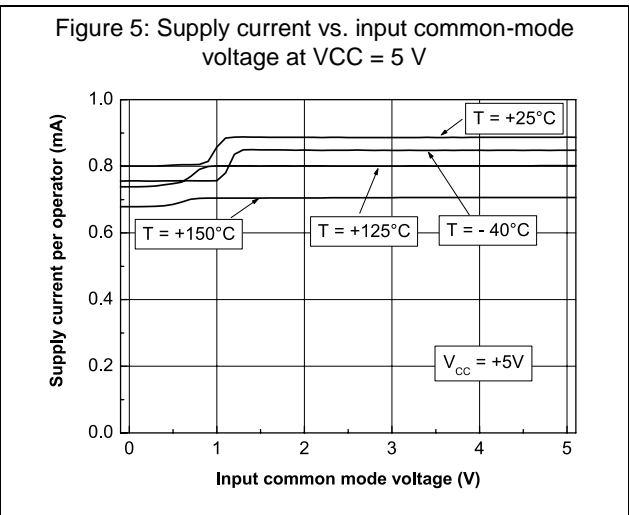
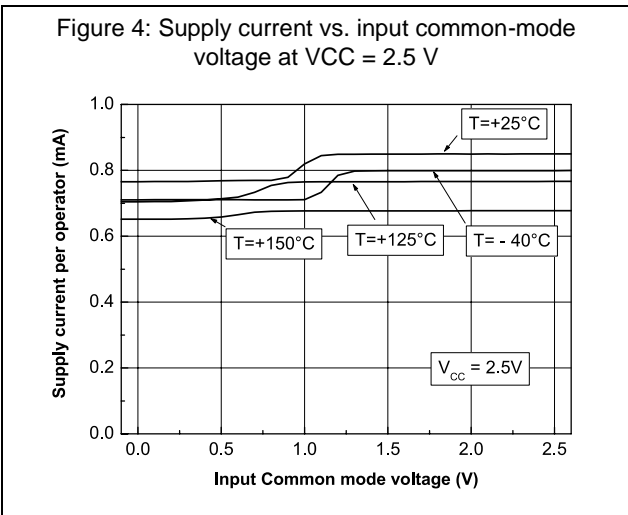
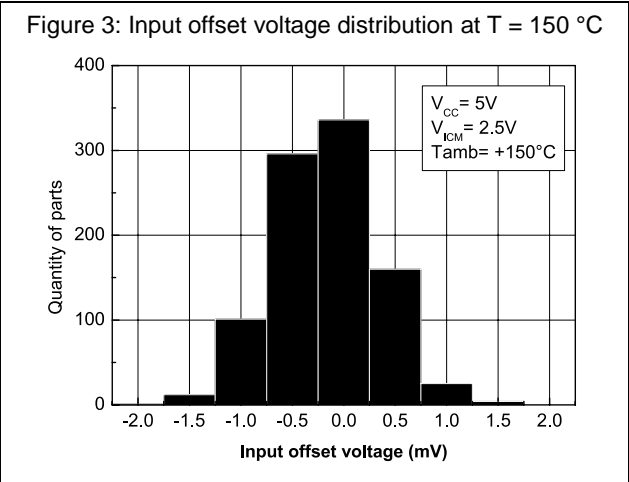
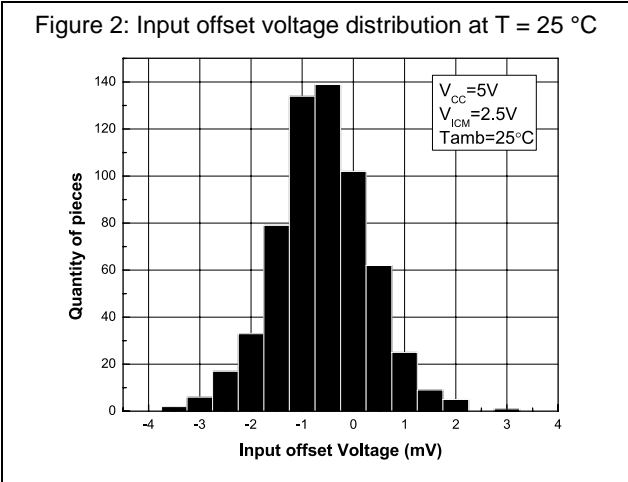

Figure 8: Voltage gain and phase vs frequency at $V_{CC} = 2.5\text{ V}$ and $V_{ICM} = 0.5\text{ V}$

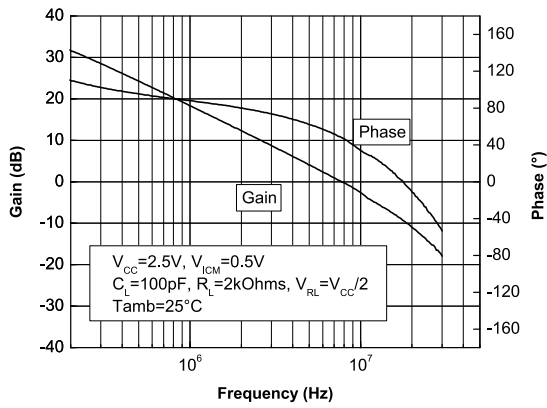

Figure 9: Voltage gain and phase vs frequency at $V_{CC} = 5.5\text{ V}$ and $V_{ICM} = 0.5\text{ V}$

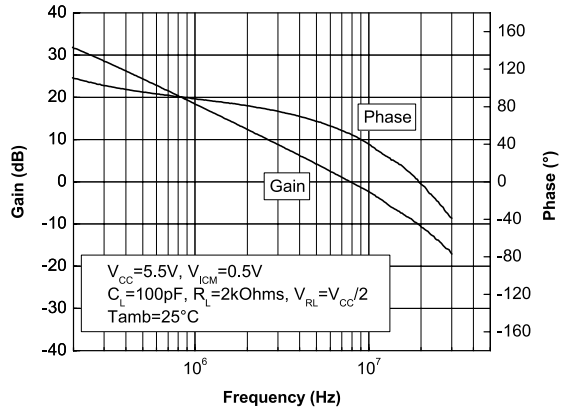

Figure 10: Phase margin vs. capacitive load

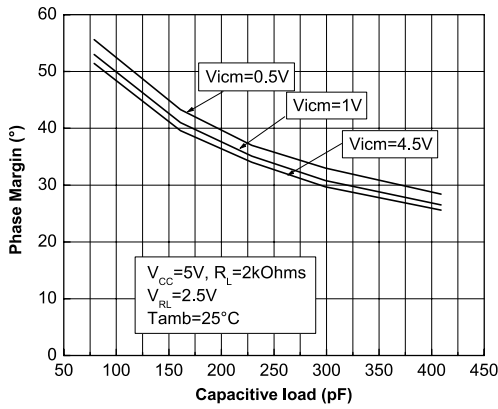

Figure 11: Phase margin vs. output current

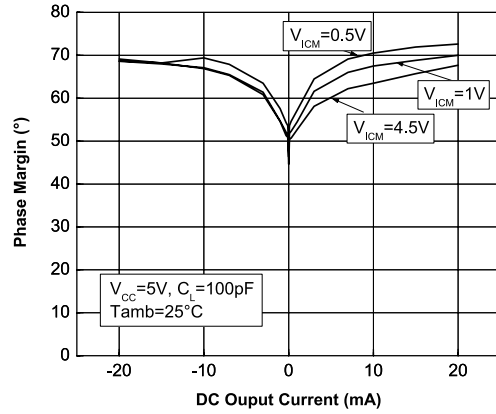

Figure 12: Positive slew rate

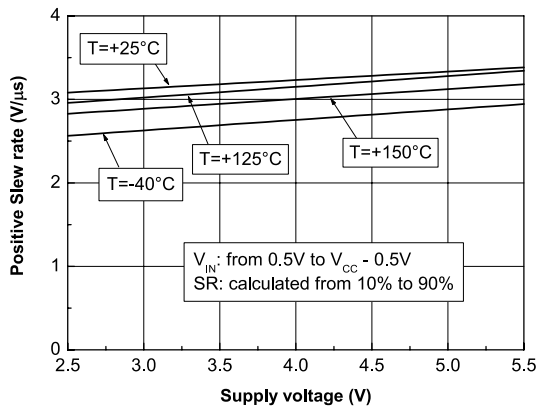
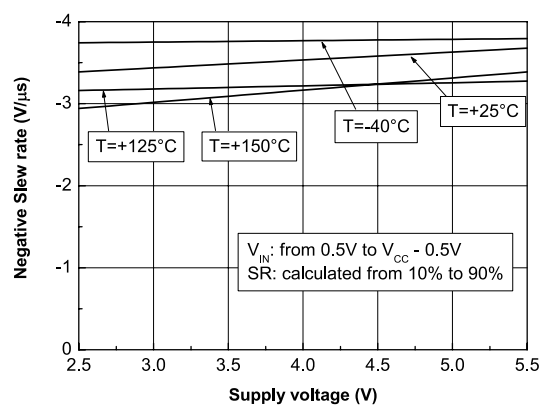
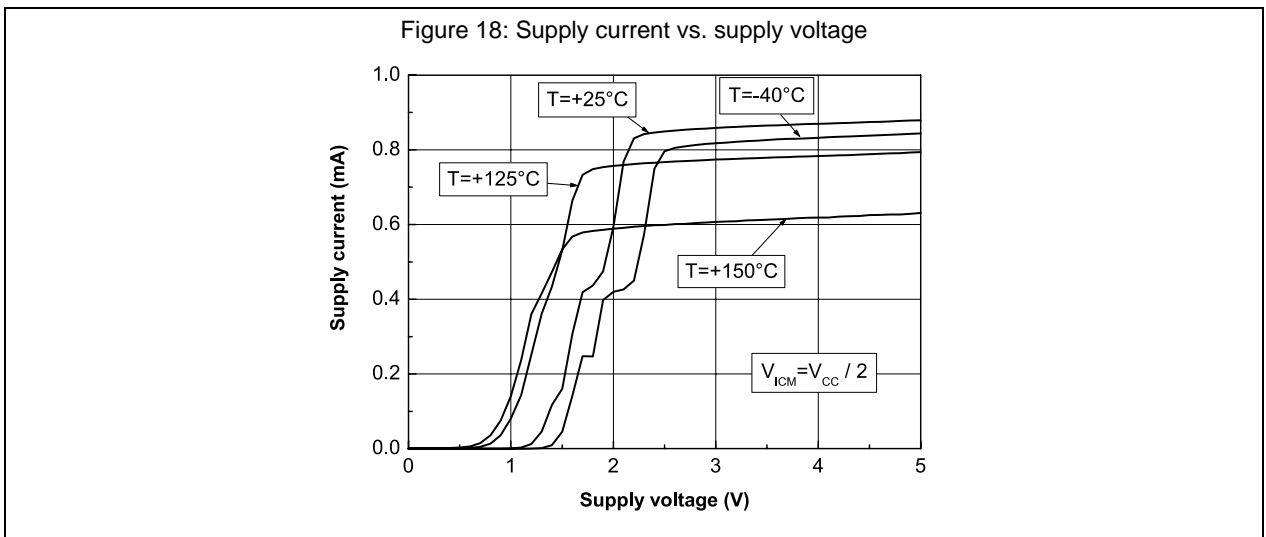
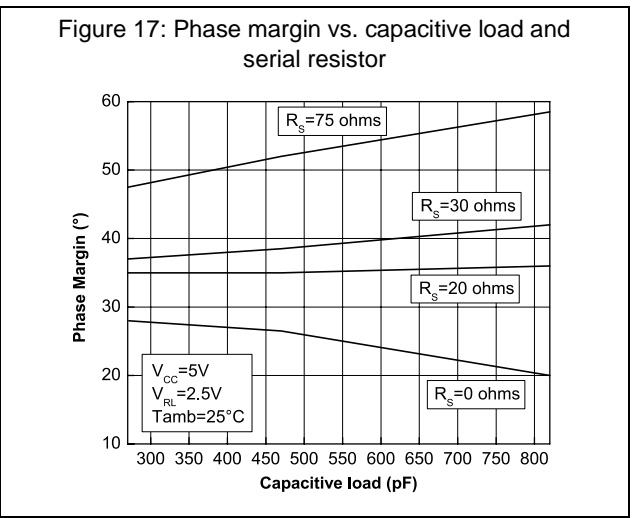
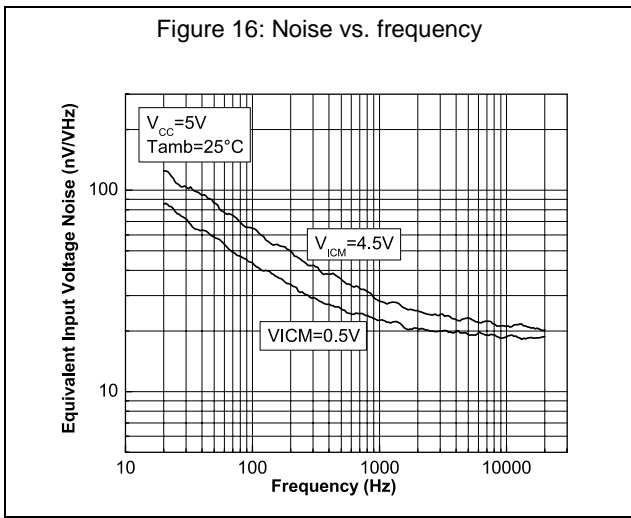
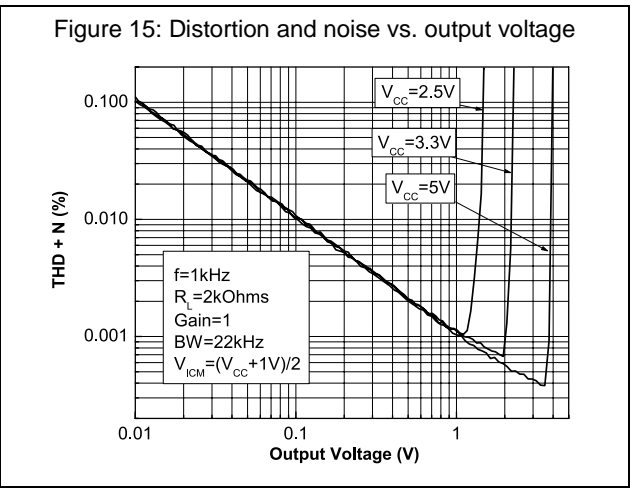
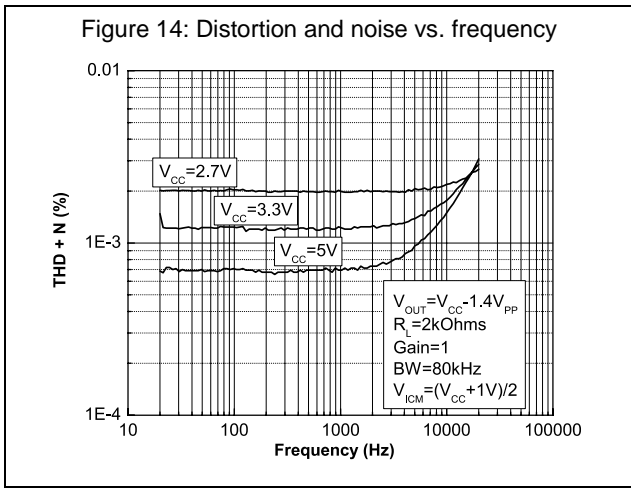

Figure 13: Negative slew rate





5 Application information

5.1 Driving resistive and capacitive loads

These products are low-voltage, low-power operational amplifiers optimized to drive rather large resistive loads above 2 kΩ.

In *follower* configuration, these operational amplifiers can drive capacitive loads up to 100 pF with no oscillations. When driving larger capacitive loads, adding a small in-series resistor at the output can improve the stability of the devices (see [Figure 19: "In-series resistor vs. capacitive load"](#) for recommended in-series resistor values). Once the in-series resistor value has been selected, the stability of the circuit should be tested on the bench and simulated with the simulation model.

Figure 19: In-series resistor vs. capacitive load

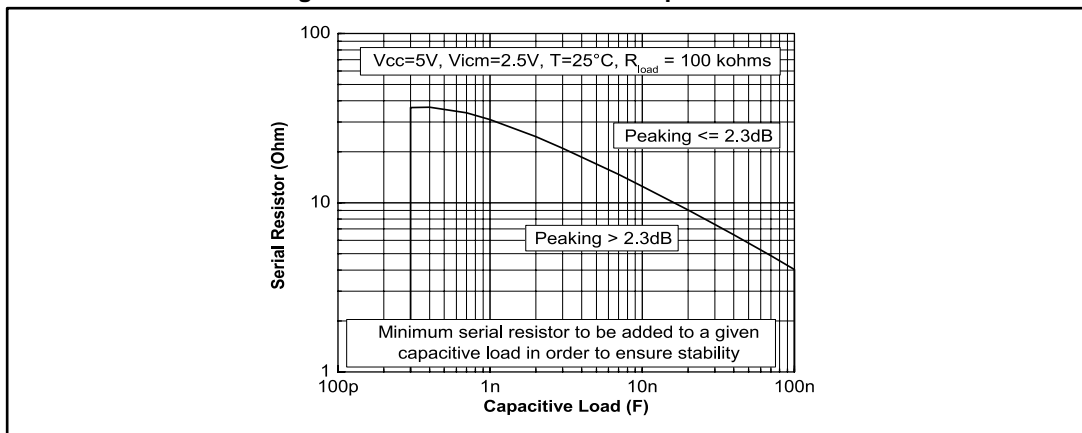

5.2 PCB layouts

For correct operation, it is advised to add 10 nF decoupling capacitors as close as possible to the power supply pins.

6 Package information

In order to meet environmental requirements, ST offers these devices in different grades of ECOPACK[®] packages, depending on their level of environmental compliance. ECOPACK[®] specifications, grade definitions and product status are available at: www.st.com. ECOPACK[®] is an ST trademark.

6.1 SO8 package information

Figure 20: SO8 package outline

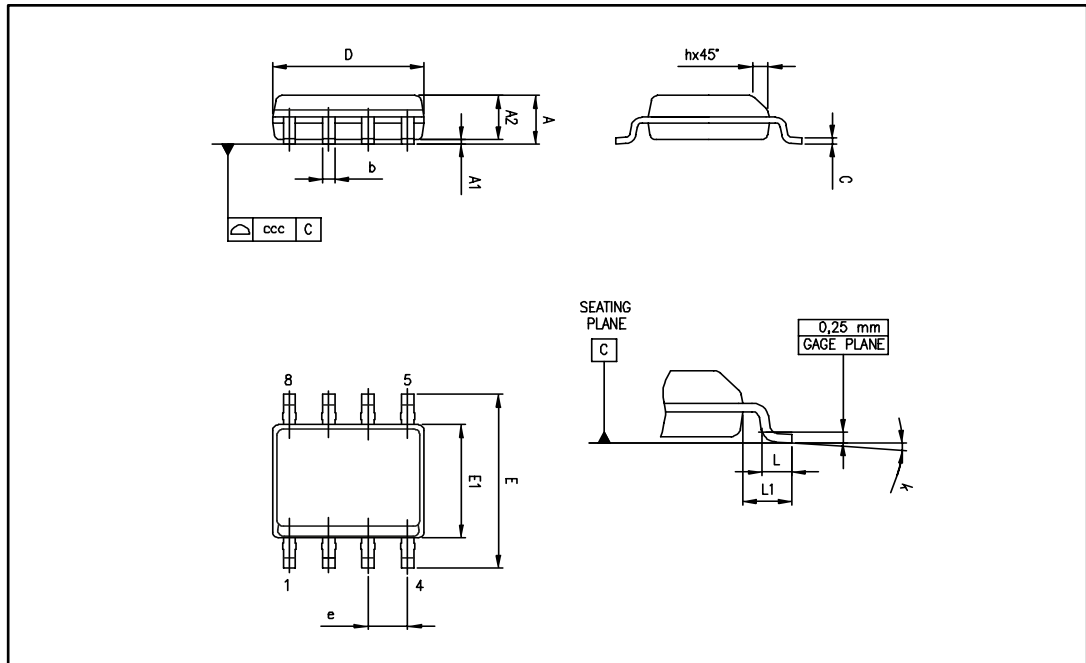

Table 6: SO8 mechanical data

Ref.	Dimensions					
	Millimeters			Inches		
	Min.	Typ.	Max.	Min.	Typ.	Max
A			1.75			0.069
A1	0.10		0.25	0.004		0.010
A2	1.25			0.049		
b	0.28		0.48	0.011		0.019
c	0.17		0.23	0.007		0.010
D	4.80	4.90	5.00	0.189	0.193	0.197
E	5.80	6.00	6.20	0.228	0.236	0.244
E1	3.80	3.90	4.00	0.150	0.154	0.157
e		1.27			0.050	
h	0.25		0.50	0.010		0.020
L	0.40		1.27	0.016		0.050
L1		1.04			0.040	
k	1°		8°	1°		8°
ccc			0.10			0.004

7 Ordering information

Table 7: Order codes

Order code	Temperature range	Package	Packing	Marking
TSV912HYDT ⁽¹⁾	-40 °C to 150 °C	SO8 ⁽²⁾ (automotive grade level)	Tape and reel	V912HY

Notes:

⁽¹⁾Qualification and characterization according to AEC Q100 and Q003 or equivalent, advanced screening according to AEC Q001 & Q 002 or equivalent.

⁽²⁾SO8 package is moisture sensitivity level 1 as per Jedec J-STD-020-C.

8 Revision history

Table 8: Document revision history

Date	Revision	Changes
08-Jul-2010	1	Initial release.
22-Feb-2016	2	Removed TSV912AH part number Updated layout <i>Table 3, Table 4, and Table 5</i> : removed all references to TSV912AH <i>Table 6</i> : updated min (mm) value for k parameter <i>Table 7: "Order codes"</i> : removed order code TSV912AHYDT

IMPORTANT NOTICE – PLEASE READ CAREFULLY

STMicroelectronics NV and its subsidiaries ("ST") reserve the right to make changes, corrections, enhancements, modifications, and improvements to ST products and/or to this document at any time without notice. Purchasers should obtain the latest relevant information on ST products before placing orders. ST products are sold pursuant to ST's terms and conditions of sale in place at the time of order acknowledgement.

Purchasers are solely responsible for the choice, selection, and use of ST products and ST assumes no liability for application assistance or the design of Purchasers' products.

No license, express or implied, to any intellectual property right is granted by ST herein.

Resale of ST products with provisions different from the information set forth herein shall void any warranty granted by ST for such product.

ST and the ST logo are trademarks of ST. All other product or service names are the property of their respective owners.

Information in this document supersedes and replaces information previously supplied in any prior versions of this document.

© 2016 STMicroelectronics – All rights reserved