

UM11761

PCA9955BTW-ARD evaluation board

Rev. 1.0 — 18 March 2022

User manual

Document information

Information	Content
Keywords	PCA9955B, I ² C-bus, LED, LED driver, Arduino port, EVK
Abstract	The “PCA9955BTW-ARD” evaluation board is a daughterboard equipped with Arduino port, designated for easy test and design of PCA9955B IC, 16-channel Fm+ I ² C-bus 57 mA / 20 V constant current LED driver. The board is fully compliant with IMXRT1050 EVK, LPCXpresso55S69 and i.MX 8M Mini LPDDR4 EVK, including GUI software control. The board can be attached to any device equipped with Arduino port.



Revision history

Rev	Date	Description
v1.0	20220318	Initial version

IMPORTANT NOTICE**For engineering development or evaluation purposes only**

NXP provides the product under the following conditions:

This evaluation kit is for use of **ENGINEERING DEVELOPMENT OR EVALUATION PURPOSES ONLY**. It is provided as a sample IC pre-soldered to a printed-circuit board to make it easier to access inputs, outputs and supply terminals. This evaluation board may be used with any development system or other source of I/O signals by connecting it to the host MCU computer board via off-the-shelf cables. This evaluation board is not a Reference Design and is not intended to represent a final design recommendation for any particular application. Final device in an application heavily depends on proper printed-circuit board layout and heat sinking design as well as attention to supply filtering, transient suppression, and I/O signal quality.

The product provided may not be complete in terms of required design, marketing, and or manufacturing related protective considerations, including product safety measures typically found in the end device incorporating the product. Due to the open construction of the product, it is the responsibility of the user to take all appropriate precautions for electric discharge. In order to minimize risks associated with the customers' applications, adequate design and operating safeguards must be provided by the customer to minimize inherent or procedural hazards. For any safety concerns, contact NXP sales and technical support services.

1 Introduction

This document describes the PCA9955BTW-ARD evaluation board, which is built around the PCA9955B, a 16-channel Fm+ I²C-bus 57 mA/20V constant current LED driver produced by NXP Semiconductors. The board works as a daughterboard which can be connected through an Arduino port to various Arduino compatible (including original Arduino Uno R3) boards. The board is intended to test and measure the characteristics of the PCA9955B Device Under Test (DUT).

The PCA9955BTW-ARD communicates through the Arduino port with the motherboard (EVK) via the bidirectional Fm+ (1 MHz) I²C-bus. Alongside the I²C-bus, three additional lines allow the motherboard to control the DUT through the same Arduino port.

The PCA9959BTW-ARD board is equipped with a pair of dedicated connectors which allow to interconnect more boards in a chain architecture.

The PCA9955BTW-ARD board can be powered in two ways: from the EVK through the Arduino port, or externally through a dedicated power connector, located on the daughterboard.

The board contains three RGB LEDs and seven white LEDs allocated to all sixteen outputs of the PCA9955B DUT. The board also contains jumpers and connectors that allows users to disconnect the on-board LEDs, to perform short tests, and to connect external LEDs to the driver outputs.

Additionally, the daughterboard has software support and a graphical user interface (Windows platform) for the following NXP evaluation boards: IMXRT1050 EVK Board, LPCXpresso55S69 Development Board and i.MX 8M Mini LPDDR4 EVK Board.

2 Finding kit resources and information on the NXP web site

NXP Semiconductors provides online resources for evaluation board and its supported device(s) on <http://www.nxp.com>.

The information page for PCA9955BTW-ARD evaluation board is at <http://www.nxp.com/PCA9955BTW-ARD>. The information page provides overview information, documentation, software and tools, parametrics, ordering information and a **Getting Started** tab. The Getting Started tab provides quick-reference information applicable to using the PCA9955BTW-ARD evaluation board, including the downloadable assets referenced in this document.

2.1 Collaborate in the NXP community

The NXP community is for sharing ideas and tips, ask and answer technical questions, and receive input on just about any embedded design topic.

The NXP community is at <http://community.nxp.com>.

3 Getting ready

Working with the PCA9955BTW-ARD requires the kit contents, additional hardware, and a Windows PC workstation with installed software.

3.1 Kit contents

- Assembled and tested evaluation board in an antistatic bag
- Quick Start Guide

3.2 Assumptions

Familiarity with the I²C bus is helpful but not required.

3.3 Static handling requirements

CAUTION



This device is sensitive to ElectroStatic Discharge (ESD). Therefore care should be taken during transport and handling. You must use a ground strap or touch the PC case or other grounded source before unpacking or handling the hardware.

3.4 Minimum system requirements

This evaluation board requires a Windows PC workstation. Meeting these minimum specifications should produce great results when working with this evaluation board.

- Computer with Windows 10
- One USB port (either 3.0 or 2.0 or 1.1 compatible)
- One of three EVK boards (MIMXRT1050-EVK, LPC55S69-EVK, 8MMINILPD4-EVK) along with the associated firmware / GUI software
- USB cable for power and data connection between PC and EVK board (if not included in the EVK package)

4 Getting to know the hardware

4.1 PCA9955BTW-ARD features

- Multiple board connection in chain architecture
- Switch for output current limit up to 20 mA / 50 mA
- Equipped with Arduino Uno R3 port for direct connection with Arduino devices
- Combined power from Arduino or external source
- On-board jumpers for LED connection, and short tests
- On-board connectors for external LEDs
- Fully compliant with IMXRT1050 EVK board, including GUI (Windows 10)
- Fully compliant with LPCXpresso55S69 development board, including GUI (Windows 10)
- Compliant with i.MX Mini LPDDR4 EVK board, including GUI (Windows 10)

Note: For i.MX Mini LPDDR4 EVK Board is necessary to use IMX8MMINI-IARD interposer board between the EVK and PCA9955BTW-ARD daughterboard (see IMX8MMINI-IARD User Manual).

4.2 Kit featured components

Figure 1 identifies the main components on the board. The main elements are called out in the picture. The DUT (U2) is located in the center of the board. The on-board LEDs connected to the driver are placed around the PCA9955B IC. The Arduino port connectors (J5, J6, J35, J36) are located on the bottom side of the board.

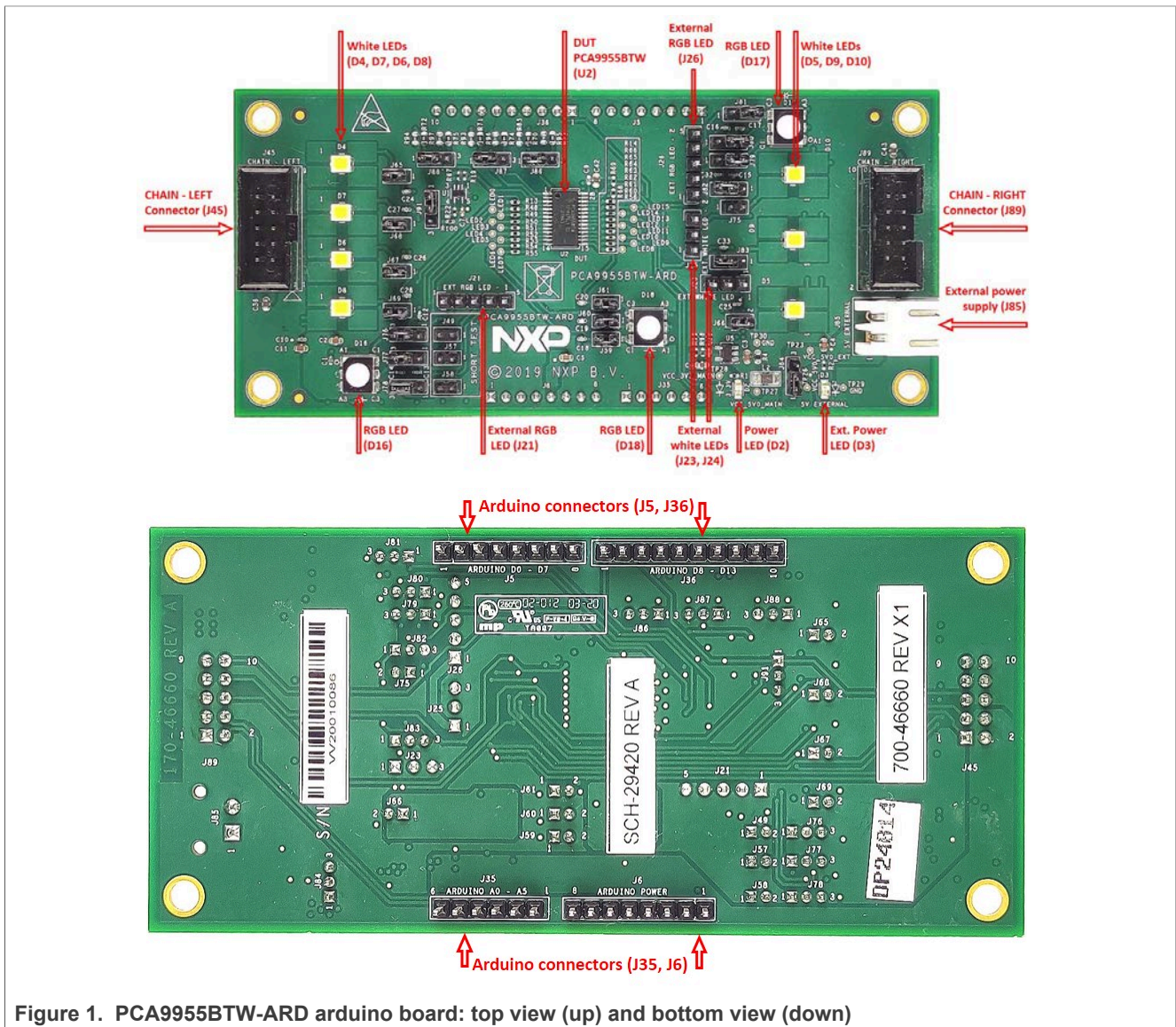

Figure 1. PCA9955BTW-ARD arduino board: top view (up) and bottom view (down)

4.3 Schematic diagram

The schematic diagram of PCA9955BTW-ARD is available at URL: <http://www.nxp.com/PCA9955BTW-ARD>.

4.4 General description

Figure 2 shows the block diagram of PCA9955BTW-ARD daughterboard. The block diagram includes the Arduino interface (J5, J6, J35, J36), the expansion connectors for

chain configuration (J45 / J89, see [Section 4.7](#)), and the on-board LEDs, connected to the output of the DUT (U2).

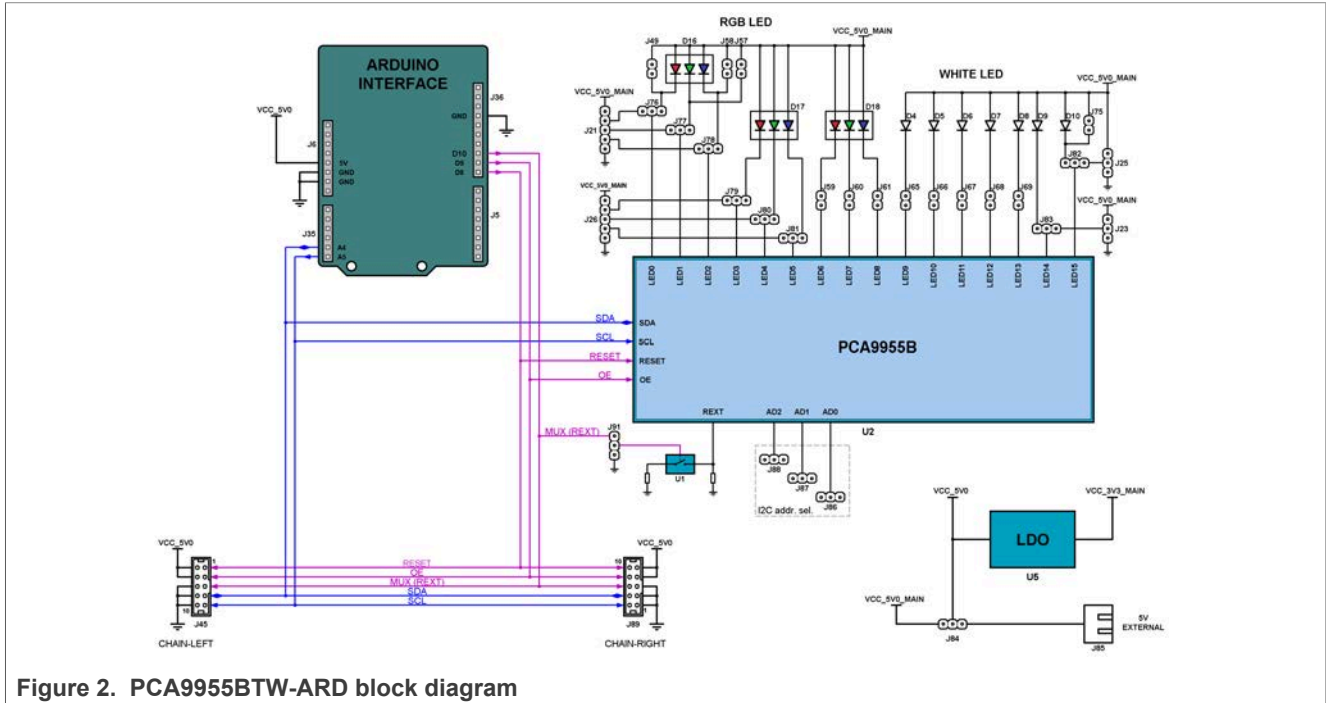

Figure 2. PCA9955BTW-ARD block diagram

The PCA9959B is controlled through an I²C interface. The motherboard (EVK) uses an I²C-bus to control the PCA9955BTW-ARD daughterboard through the Arduino port. The blue lines in the drawing refer to the I²C-bus. From the Arduino connector J35, the I²C lines are connected to the SDA / SCL pins of the DUT (U2, pin 26, and 27), and to the expansion connectors J45 and J89. For more details, see the schematic diagram of the PCA9955BTW-ARD board.

The target address of the PCA9955B can be configured for 125 different target addresses, by unique combination of five states to three address inputs of the IC (U2, pin 2, 3, and 4). For details, see PCA9955B datasheet (NXP Semiconductors). The jumper headers J86, J87 and J88, allow to select only 27 from 125 possible addresses. [Table 1](#) depicts the target address depending on the position of the address jumpers. Note that the default selected address is BCh.

Table 1. I²C target address chart

J88 position	J87 position	J86 position	I ² C target address (HEX)
1-2	1-2	1-2	BCh (default)
1-2	1-2	2-3	B8h
1-2	1-2	OFF	BAh
1-2	2-3	1-2	A8h
1-2	2-3	2-3	A4h
1-2	2-3	OFF	A6h
1-2	OFF	1-2	B2h
1-2	OFF	2-3	Aeh

Table 1. I²C target address chart...continued

J88 position	J87 position	J86 position	I ² C target address (HEX)
1-2	OFF	OFF	B0h
2-3	1-2	1-2	58h
2-3	1-2	2-3	54h
2-3	1-2	OFF	56h
2-3	2-3	1-2	44h
2-3	2-3	2-3	40h
2-3	2-3	OFF	42h
2-3	OFF	1-2	4Eh
2-3	OFF	2-3	4Ah
2-3	OFF	OFF	4Ch
OFF	1-2	1-2	8Ah
OFF	1-2	2-3	86h
OFF	1-2	OFF	88h
OFF	2-3	1-2	76h
OFF	2-3	2-3	72h
OFF	2-3	OFF	74h
OFF	OFF	1-2	80h
OFF	OFF	2-3	7Ch
OFF	OFF	OFF	7Eh

Alongside the I²C-bus, the circuit contains three control lines: the OE, RESET, and MUX (REXT). In the block diagram the control lines are drawn with purple. The OE and RESET lines control the corresponding OE and RESET inputs of the PCA9955B IC (U2, pin 5, and 25). Driving low the OE input, enables all sixteen outputs of the LED driver. Driving low the RESET input, sets the internal registers of PCA9959B to their default state. For more details, see PCA9955B datasheet (NXP Semiconductors).

The limit current for each output of PCA9955B is set by a resistor connected between REXT (U2, pin 1) and ground. The switch U5 allows to select two values for current limit: 20 mA (U1 – OFF), and 50 mA (U1 – ON). The state of U1 switch is controlled through the MUX (REXT) line.

All control lines (purple color in the block diagram picture) are connected to the expansion connectors J45 and J89. For more details, see the schematic diagram of the PCA9955BTW-ARD board.

The PCA9955B features sixteen LED drivers (PWM controlled, current sink sources). Three RGB LEDs are allocated to the first outputs (LED0 to LED8). The outputs LED9 to LED15 drives white LEDs. The LEDs can be disconnected from the IC outputs with jumpers.

The RGB LED D16 has jumpers connected in parallel for short testing. The jumpers J76 to J81 allows the user to redirect the corresponding output lines of D16 and D17 RGB LEDs from the on-board LEDs to the RGB LED external connectors (J21 and J26). Using the connectors, the user can easily attach external LEDs for testing. In the same manner,

the corresponding lines of white LEDs D9 and D10 can be redirected with J82 and J83 jumpers to white LED external connectors J23 and J25.

4.5 Arduino port

J5, J6, J35, and J36 are the mated pin headers of Arduino Uno R3 connectors, having the same electrical function and placed on the board, so that the daughterboard can be directly inserted in the Arduino port. The daughterboard uses only five signal lines. [Table 1](#) lists the pin chart of connectors, and the lines used in the circuit (see also the SPF-46660_A1.pdf schematic file):

Table 2. The pin chart of Arduino connectors and their usage

Ref Des	#	Arduino label	PCA9955BTW-ARD function
J6 (Power)	1	NC	Not used
	2	IOREF	Not used
	3	RESET	Not used
	4	3.3V	Not used
	5	5V	Power supply
	6	GND	Power supply return
	7	GND	Power supply return
	8	Vin	Not used
J35 (analog, digital, I²C)	1	A0	Not used
	2	A1	Not used
	3	A2	Not used
	4	A3	Not used
	5	A4 / SDA	I ² C – SDA
	6	A5 / SCL	I ² C – SCL
J5 (digital, UART, PWM)	1	D0 / RX	Not used
	2	D1 / TX	Not used
	3	D2	Not used
	4	D3 / PWM	Not used
	5	D4	Not used
	6	D5 / PWM	Not used
	7	D6 / PWM	Not used
	8	D7	Not used
J36 (mixed)	1	D8	RESET
	2	D9 / PWM	OE
	3	D10 / SS / PWM	MUX (REXT)
	4	D11 / MOSI / PWM	Not used
	5	D12 / MISO	Not used
	6	D13 / SCK	Not used

Table 2. The pin chart of Arduino connectors and their usage...continued

Ref Des	#	Arduino label	PCA9955BTW-ARD function
	7	GND	Power supply return
	8	AREF	Not used
	9	A4 / SDA	Not used
	10	A5 / SCL	Not used

The circuit is supplied with 5 V from Arduino port through J6 and J36. Pin 5 of J6 is 5 V power supply, while pin 6 and 7 of J6 and pin 7 of J36 represent the power supply return (ground).

4.6 Power distribution

The electrical circuit of PCA9955BTW-ARD is supplied from 5 V and 3.3 V power rails. The 5 V power supply can be provided from two sources: from the EVK through the Arduino port, and externally through the power connector J85. The jumper header J8 selects the 5 V source. The 3.3 V rail is obtained with the LDO regulator U5, from the 5 V rail. The necessary current for one daughterboard when all LEDs are ON is 800 mA (I limit set to 50 mA). If one board is used, there is no limitation or restriction regarding the 5 V power source. If more boards are used in a chain configuration (see [Section 4.7](#)), when the power is supplied by EVK through the Arduino port, due to current limitation, the number of boards connected in the chain is limited. The limitation depends on the type of EVK being used and the current rating of the Arduino connectors. The current limitation as a function of EVK is as follows:

- IMXRT1050 EVK:
 - EVK powered from USB: limited by the current rating of the USB connector – maximum 3 boards;
 - EVK powered from power barrel connector (J2): limited by power rating of Arduino / Fuji connectors – maximum 4 boards;
- LPCXpresso55S69 EVK: limited by the current rating of the USB connector – maximum 3 boards;
- i.MX LPDDR4 EVK: limited by the current delivered by the EVK power supply – maximum 3 boards;

When the 5 V power is provided externally (through J85), there is no power limitation, regarding the number of boards used in the chain. The on-board LED D2 is 3.3 V rail indicator, and D3 is 5 V external indicator.

4.7 Chain configuration

The expansion connectors J45 and J89 allow to interconnect more boards in a chain configuration, as is shown in [Figure 3](#). J45 is labeled as “CHAIN – LEFT”, while J89 is “CHAIN – RIGHT”. The mains are given upon their position on the daughterboard (J45 is placed in the left side, while J89 in placed in the right side of the board). Note that, when more boards are used in a chain configuration, each board must set its individual target address. When the boards are supplied from the EVK, the number of board are limited due to power consumption of the boards. See [Section 4.6](#) for more details. To overcome this limitation, use an external power supply. [Table 3](#) depicts the pin chart of expansion connectors, J45 and J89.

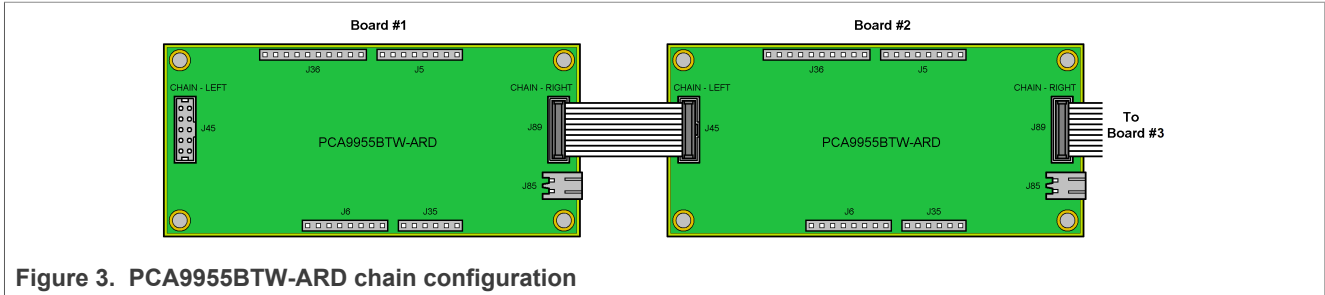

Figure 3. PCA9955BTW-ARD chain configuration

Table 3. The expansion connector J45 / J89 pin chart

Signal line	CHAIN – LEFT (J45) pin no.	CHAIN – RIGHT (J89) pin no.
SDA	7	4
SCL	9	2
OE	3	8
RESET	1	10
MUX (REXT)	5	6
VCC_5V0	2, 4	7, 9
GND	6, 8, 10	1, 3, 5

4.8 Jumpers and test points

The board contains 25 jumpers and 22 test points. [Table 4](#) and [Figure 4](#) details the jumper locations and their default configurations. [Table 5](#) describes the test points located on the PCA9955BTW-ARD board.

Table 4. PCA9955BTW-ARD jumpers

Ref Des	Default	Description
J91	1-2	1-2: I _{max} - REMOTE
		2-3: I _{max} - 20 mA
		OFF: I _{max} - 50 mA
J84	1-2	1-2: Power from ARDUINO
		2-3: External POWER
J86	1-2	1-2/1-2/1-2: I ² C Address = BCh (Hex) For more details about I ² C address see Table 1
J87	1-2	
J88	1-2	
J65	ON	ON: D4 – ON (LED D4 connected to driver)
		OFF: D4 – OFF (LED D4 disconnected from driver)
J66	ON	ON: D5 – ON (LED D5 connected to driver)
		OFF: D5 – OFF (LED D5 disconnected from driver)
J67	ON	ON: D6 – ON (LED D6 connected to driver)
		OFF: D6 – OFF (LED D6 disconnected from driver)
J68	ON	ON: D7 – ON (LED D7 connected to driver)

Table 4. PCA9955BTW-ARD jumpers...continued

Ref Des	Default	Description
		OFF: D7 – OFF (LED D7 disconnected from driver)
J69	ON	ON: D8 – ON (LED D8 connected to driver)
		OFF: D8 – OFF (LED D8 disconnected from driver)
J83	2-3	1-2: EXTERNAL (external LED)
		2-3: D9 – ON (LED D9 connected to driver)
		OFF: D9 – OFF (LED D9 disconnected from driver)
J82	2-3	1-2: EXTERNAL (external LED)
		2-3: D10 – ON (LED D10 connected to driver)
		OFF: D10 – OFF (LED D10 disconnected from driver)
J76	2-3	1-2: EXTERNAL (external LED)
		2-3: D16/RED – ON (LED D16/RED connected to driver)
		OFF: D16/RED – OFF (LED D16/RED disconnected from driver)
J77	2-3	1-2: EXTERNAL (external LED)
		2-3: D16/GREEN – ON (LED D16/GREEN connected to driver)
		OFF: D16/GREEN – OFF (LED D16/GREEN disconnected from driver)
J78	2-3	1-2: EXTERNAL (external LED)
		2-3: D16/BLUE – ON (LED D16/BLUE connected to driver)
		OFF: D16/BLUE – OFF (LED D16/BLUE disconnected from driver)
J79	2-3	1-2: EXTERNAL (external LED)
		2-3: D17/RED – ON (LED D17/RED connected to driver)
		OFF: D17/RED – OFF (LED D17/RED disconnected from driver)
J80	2-3	1-2: EXTERNAL (external LED)
		2-3: D17/GREEN – ON (LED D17/GREEN connected to driver)
		OFF: D17/GREEN – OFF (LED D17/GREEN disconnected from driver)
J81	2-3	1-2: EXTERNAL (external LED)
		2-3: D17/BLUE – ON (LED D17/BLUE connected to driver)
		OFF: D17/BLUE – OFF (LED D17/BLUE disconnected from driver)
J59	ON	ON: D18/RED – ON (LED D18/RED connected to driver)
		OFF: D18/RED – OFF (LED D18/RED disconnected from driver)
J60	ON	ON: D18/GREEN – ON (LED D18/GREEN connected to driver)
		OFF: D18/GREEN – OFF (LED D18/GREEN disconnected from driver)
J61	ON	ON: D18/BLUE – ON (LED D18/BLUE connected to driver)
		OFF: D18/BLUE – OFF (LED D18/BLUE disconnected from driver)
J75	OFF	OFF (D10 – normal operation)
		ON – SHORT TEST (D10 shorted)
J49	OFF	OFF (D16/RED – normal operation)

Table 4. PCA9955BTW-ARD jumpers...continued

Ref Des	Default	Description
J57	OFF	ON – SHORT TEST (D16/RED shorted)
		OFF (D16/GREEN – normal operation)
		ON – SHORT TEST (D16/GREEN shorted)
J58	OFF	OFF (D16/BLUE – normal operation)
		ON – SHORT TEST (D16/BLUE shorted)

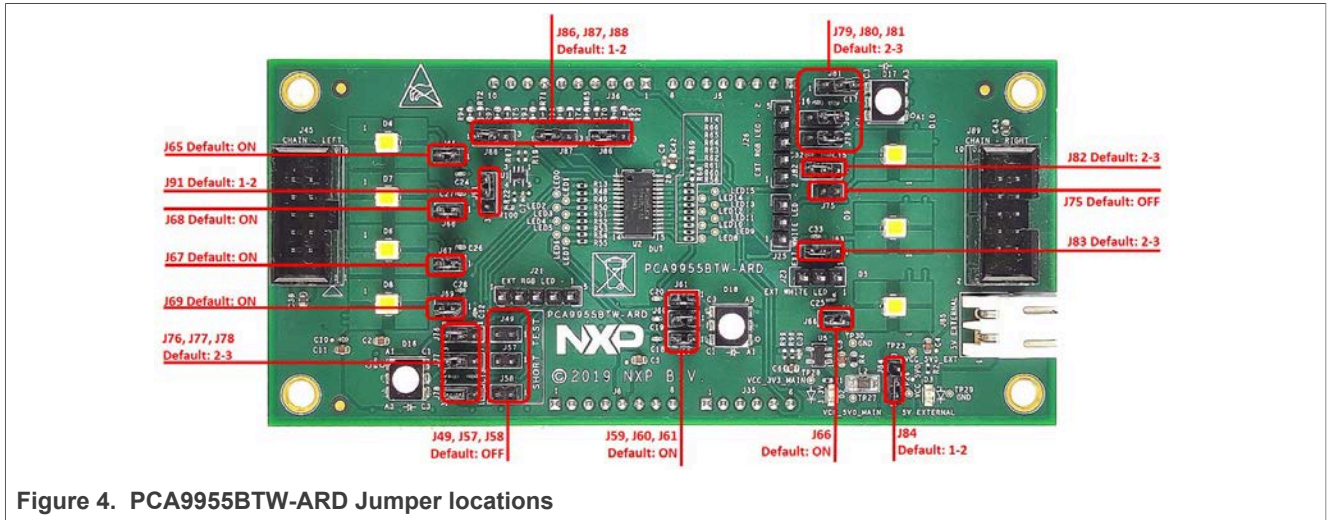

Figure 4. PCA9955BTW-ARD Jumper locations

Table 5. PCA9955BTW-ARD test points

Ref Des	Test point / jumper label	Description
TP1	LED0	RGB_R1 (RGB LED channel R1)
TP2	LED1	RGB_G1 (RGB LED channel G1)
TP3	LED2	RGB_B1 (RGB LED channel B1)
TP4	LED3	RGB_R2 (RGB LED channel R2)
TP5	LED4	RGB_G2 (RGB LED channel G2)
TP6	LED5	RGB_B2 (RGB LED channel B2)
TP7	LED6	RGB_R3 (RGB LED channel R3)
TP8	LED7	RGB_G3 (RGB LED channel G3)
TP9	LED8	RGB_B3 (RGB LED channel B3)
TP13	LED9	White LED W1
TP14	LED10	White LED W2
TP15	LED11	White LED W3
TP16	LED12	White LED W4
TP17	LED13	White LED W5

Table 5. PCA9955BTW-ARD test points...continued

Ref Des	Test point / jumper label	Description
TP18	LED14	White LED W6
TP19	LED15	White LED W7
TP23	VCC_5V0_EXT	5 V external power rail
TP26	VCC_5V0	5 V power rail (Arduino connector)
TP27	VCC_5V0_MAIN	5 V main power rail
TP28	VCC_3V3_MAIN	3.3 V main power rail
TP29	GND	Ground
TP30	GND	Ground

5 Installing and configuring software tools

PCA9955BTW-ARD evaluation board is designed and built as a daughterboard able to work in conjunction with a motherboard equipped with an Arduino port. The board was built to be fully compatible with the following NXP Evaluation (EVK) boards:

- IMXRT1050 EVK Board
- LPCXpresso55S69 Development Board
- i.MX 8M Mini LPDDR4 EVK Board

Each mentioned above evaluation / development board benefits by firmware support which can be downloaded from NXP company site (www.nxp.com/). Before starting, the EVK motherboard must be programmed with the corresponding firmware package. Additionally, a GUI application (Windows 10) is available for download from the NXP site, allowing rapid testing and operation of PCA9955BTW-ARD daughterboard through the one of above mentioned EVK. For details regarding installation of the EVK firmware and GUI host software on PC please download *UM11581, Arduino Shields GUI and firmware installation* from (www.nxp.com/). Once the software is installed, the first step is to select the correct combination EVK – PCA9955BTW-ARD daughterboard, and then the board can be controlled from the GUI interface. See [Section 7](#) and [Section 8](#) for more details regarding the operation of PCA9955BTW-ARD from GUI software.

6 Configuring the hardware

6.1 Using the PCA9955BTW-ARD with an IMXRT1050 EVK board

[Figure 5](#) shows the required hardware for operation of the PCA9955BTW-ARD daughterboard with IMXRT1050 EVK. The following items are necessary:

- One IMXRT1050-EVK board
- One PCA9955BTW-ARD daughterboard
- One USB-A / USB Micro-B cable
- A PC with Windows 10 operating system

The IMXRT1050 EVK motherboard can be powered by one of the three methods:

- Connecting an external 5VDC power supply to the barrel power connector (J2) on the board

- Connecting an USB cable from the PC to the Micro-B USB connector (J9) on the board
- Connecting an USB cable from the PC to the USB connector (J28) on the board. When the PC is connected in this fashion, the USB port can simultaneously act as a debug interface. Therefore, by using a single USB cable connected to J28, the EVK can be powered and at the same time linked to the PC for data exchange.

The older USB ports (from PC) are not able to deliver the necessary current (500mA), before establishing the communication, use an external power supply (connected to J2).

From J1 on the EVK board (see [Figure 5](#)) the user can select the power configuration for the motherboard. For further details, see the [i.MX RT1050 Processor Reference Manual](#).

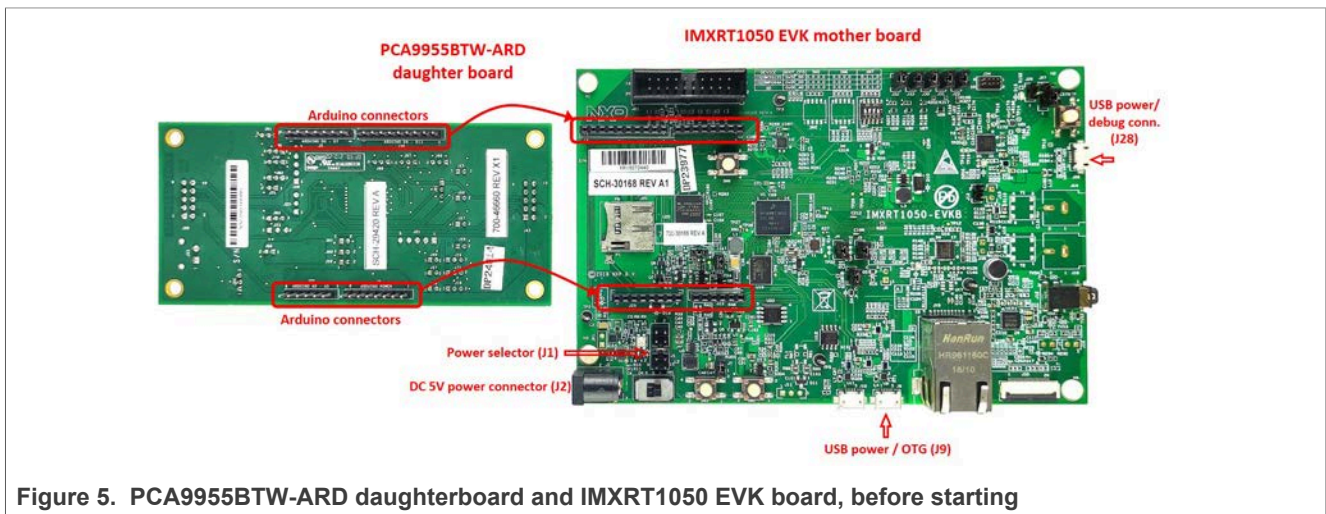

Figure 5. PCA9955BTW-ARD daughterboard and IMXRT1050 EVK board, before starting

To configure the hardware and workstation, complete the following procedure:

1. Configure the suitable power configuration of EVK (J1). If using J28 for power supply, the J1 jumper shall be placed in position 5-6. If using an external power supply (connected to J2), the jumper J1 will be placed in position 1-2.
2. Insert the PCA9955BTW-ARD daughterboard on the Arduino connector of the EVK (see [Figure 5](#) and [Figure 6](#)).
3. Using USB connector J28, connect the EVK board to an USB port of the computer.
4. Install the IMXRT1050 target firmware (download from NXP site and see UM11581, Arduino [Arduino shields GUI and firmware installation manual](#) for step-by-step instructions).
5. Install GUI application (see [UM11581, Arduino shields GUI and firmware installation manual](#)).
6. Open the GUI application to operate the device from the PC. For details regarding GUI operation see [Section 7](#).

[Figure 6](#) shows the boards during the operation.

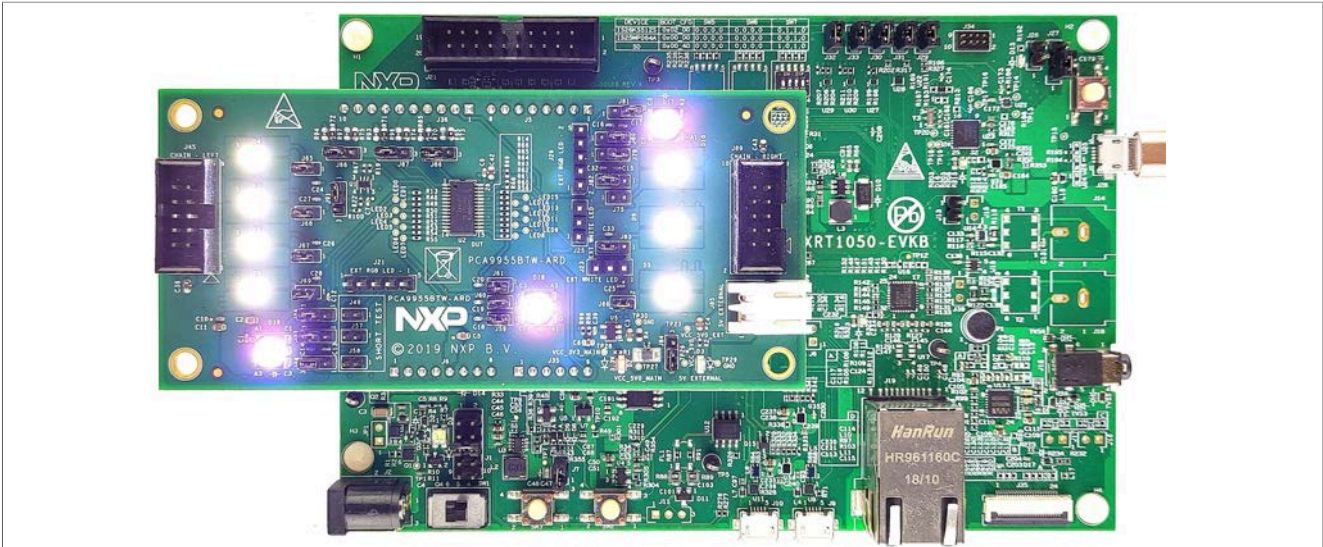

Figure 6. The assembly PCA9955BTW-ARD daughterboard / IMXR1050 EVK board operation

6.2 Using the PCA9955BTW-ARD with an LPCXpresso55S69 development board

Figure 7 shows the required hardware for operation of the PCA9955BTW-ARD and LPCXpresso55S69 EVK board. This configuration consists of:

- One LPCXpresso55S69 EVK board
- One PCA9955BTW-ARD daughterboard
- One USB-A / USB Micro-B cable
- A PC with Windows 10 operating system

The LPCXpresso55S69 development board is equipped with four USB Micro-B connectors: P5, P6, P9 and P10. The board can be powered through any USB port. Using P6 USB connector to connect the board to the PC simplifies the start-up operation because P6 is designated for debugging and the USB cable thus accomplishes two tasks at the same time: powering the board, and serving as a data link between the EVK board and PC. For more details regarding power-up and operation of the LPCXpresso55S69 development board, see the *LPCXpresso55S69/LPCXpresso55S28 Development Board User Manual* [here](#).

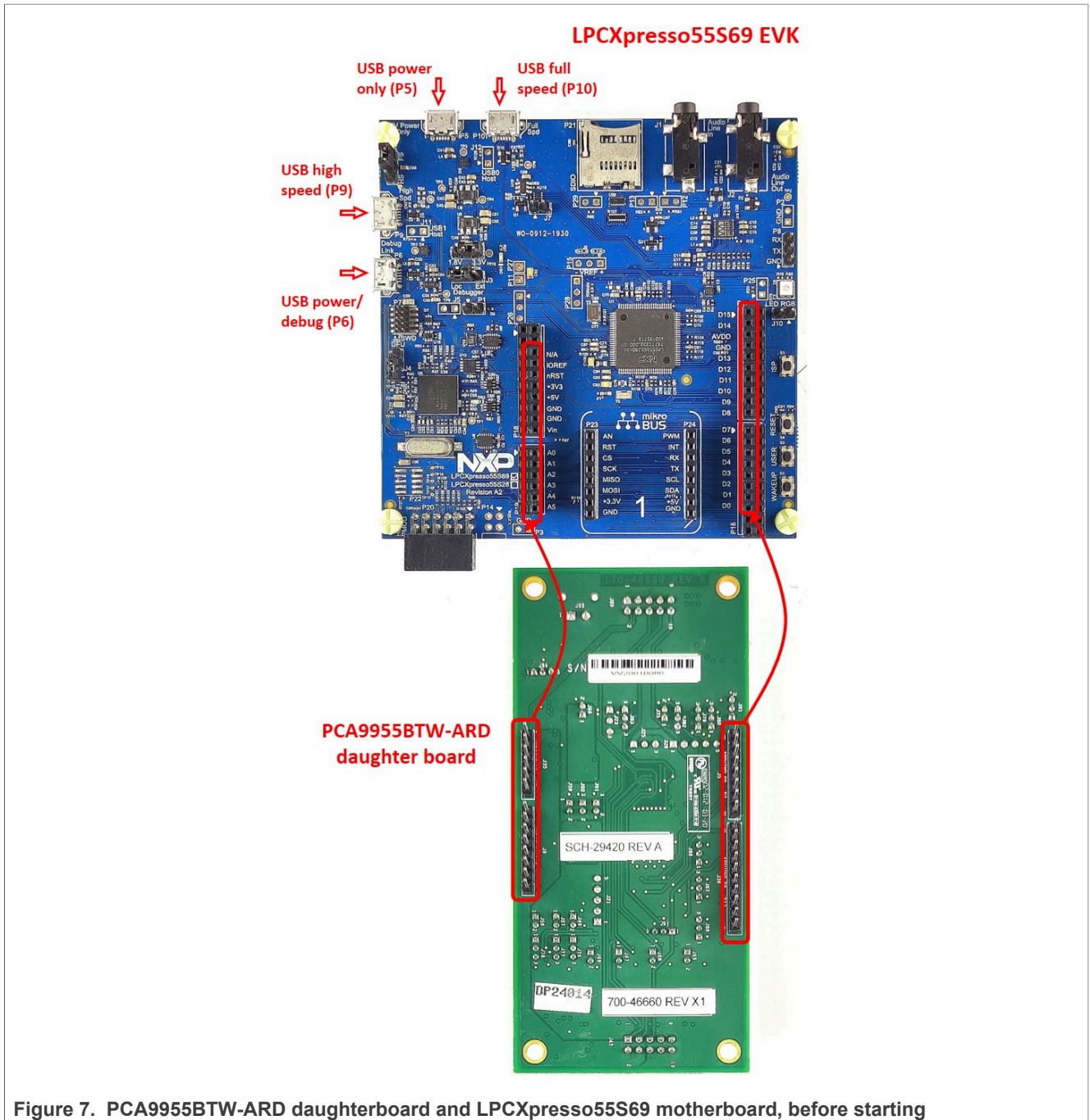

Figure 7. PCA9955BTW-ARD daughterboard and LPCXpresso55S69 motherboard, before starting

The following steps describe how to assemble, program, and operate the configuration shown in [Figure 7](#).

1. Insert the PCA9955BTW-ARD daughterboard to P16 – P19 connectors located on LPCXpresso55S69 development board (see the marked pins of P16 – P19, [Figure 7](#))
2. Connect the development board using port P6 USB port of PC
3. Install the LPCXpresso55S69 target firmware (download from NXP site and read the *EVK_Firmware_And_GUI_Install_Guide_For_Arduino_Boards.pdf* instruction file)
4. Install GUI application on PC (see the instruction file called out in the previous step)

5. Open the GUI application to operate the device from the PC. For details regarding GUI operation see [Section 7](#)

[Figure 8](#) shows the two boards in operation.

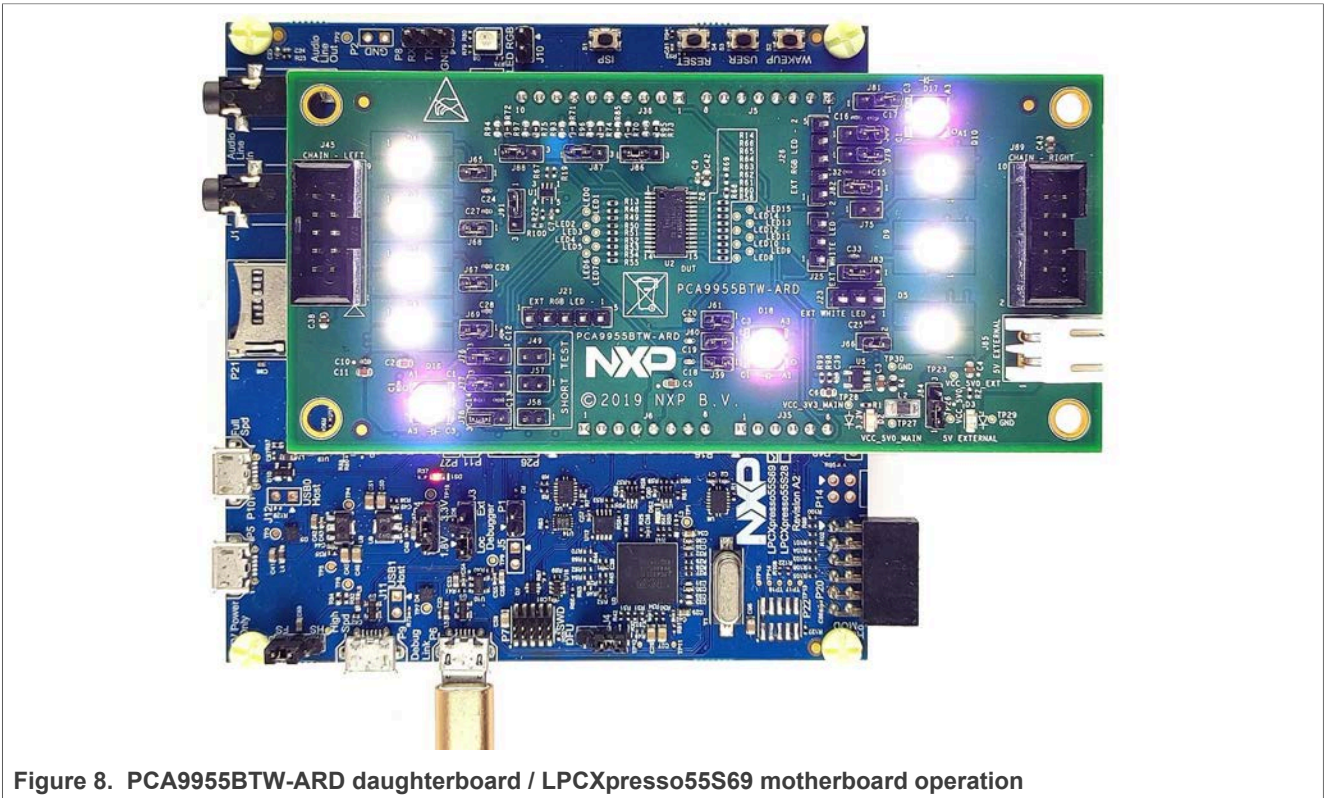

Figure 8. PCA9955BTW-ARD daughterboard / LPCXpresso55S69 motherboard operation

6.3 Using the PCA9955BTW-ARD with an i.MX 8M Mini LPDDR4 EVK board

When an i.MX 8M Mini LPDDR4 EVK board is used with the PCA9955BTW-ARD board, a third board (IMX8MMINI-IARD interposer board) must be used, especially designed and built as an EVK/daughterboard interconnection. The EVK board i.MX 8M Mini LPDDR4 is not equipped with an Arduino port; instead it has a 2 x 20 pin expansion connector (J1003, see i.MX 8M Mini LPDDR4 EVK user manual). J1003 is a multipurpose port, containing various digital I/O lines, including specialized I²C and SPI buses. Starting from the expansion connector pin chart, an Arduino port interposer board was developed, with the role of signal-to-signal bridge between the 2 x 20 connector pins on the i.MX 8M Mini LPDDR4 EVK and the mated connectors of the Arduino port present on the PCA9955BTW-ARD daughterboard.

To operate the setup, along with the EVK and the daughterboard, a third board must be included in the setup assembly. [Figure 9](#) shows the necessary boards and how these boards are connected. The configuration consists of:

- One i.MX 8M Mini LPDDR4 EVK board
- One PCA9955BTW-ARD daughterboard
- One IMX8MMINI-IARD interposer board
- One USB-A / USB-C cable
- One USB-A / USB Micro-B cable

- A PC with Windows 10 operating system

It is recommended to attach the PCA9955BTW-ARD to the Arduino connectors of the IMX8MMINI-IARD interposer board first, and then the resulting assembly to the i.MX 8M Mini LPDDR4 EVK. This can be done by plugging J1 connector located on the interposer board to J1003 connector on the EVK.

To power-up the EVK, an USB-C type cable connected to PORT 2 of the EVK is used. The power switch SW101 on the EVK board must be set to ON position to power-up the setup. Data communication is achieved by routing a separate USB (Micro-B type) cable from an USB port on the PC to debug port (J901) on the EVK (see [Figure 9](#) and [Figure 10](#)).

The user may find details regarding power-up and operation of the setup assembly in *8MMINI-LPDDR4-EVK user manual* and *IMX8MMINI-IARD User Manual*. The files can be downloaded from www.nxp.com/.

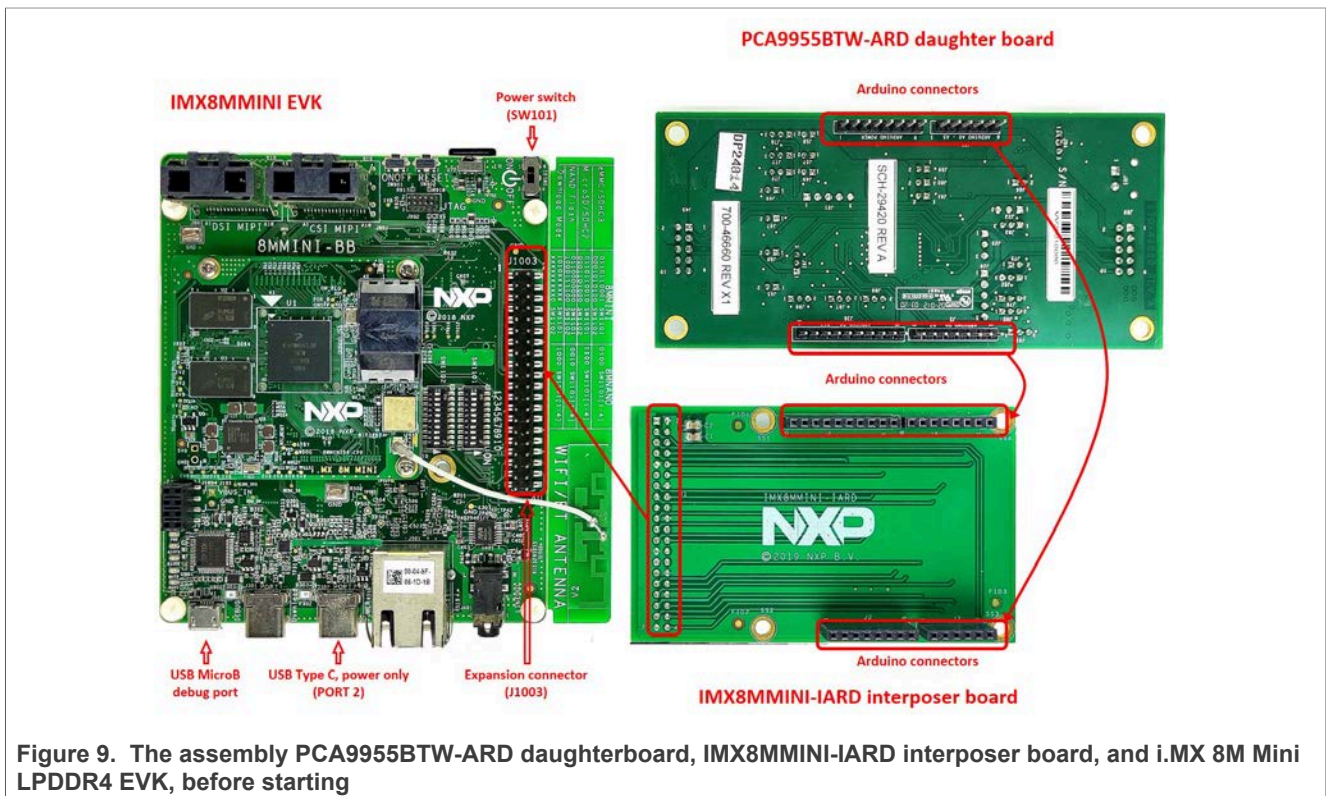

Figure 9. The assembly PCA9955BTW-ARD daughterboard, IMX8MMINI-IARD interposer board, and i.MX 8M Mini LPDDR4 EVK, before starting

To configure and operate the setup, follow the below steps:

1. Insert the PCA9955BTW-ARD onto the IMX8MMINI-IARD interposer board Arduino connectors (located on the top side);
2. Attach IMXMMINI-IARD connector plug J1 (located on the bottom of the board) into J1003 expansion board located on the top side of i.MX 8M Mini LPDDR4 EVK (see [Figure 9](#));
3. Power-up the EVK board using an USB Type C cable attached to PORT 2;
4. Connect the EVK to the PC, using an USB Micro-B cable, attached to J901 debug port;
5. Place SW101 in ON position to power-up the boards;

6. Install the MIMXRT1050 target firmware (download [UM11581](#), [Arduino shields GUI and firmware installation manual](#) from NXP site);
7. Install GUI application on the PC (see the instruction file referred in the above step);
8. Open the GUI application to operate the device from the PC. For details regarding GUI operation see [Section 7](#);

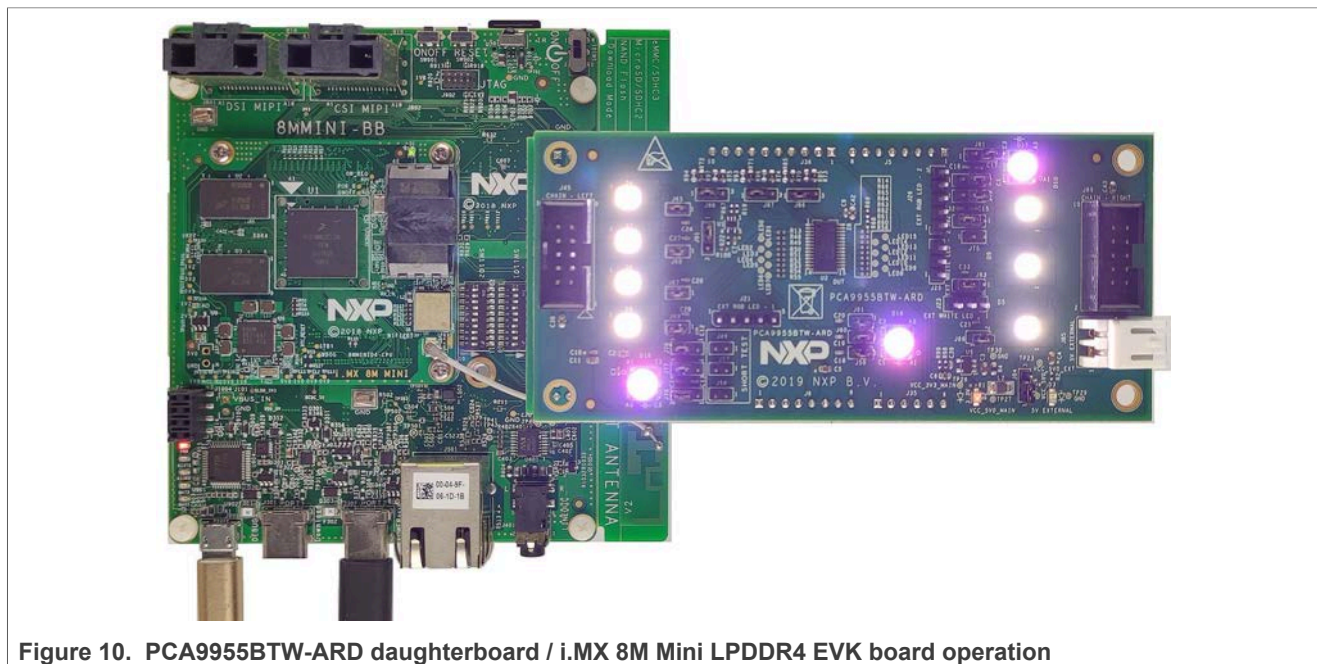

Figure 10. PCA9955BTW-ARD daughterboard / i.MX 8M Mini LPDDR4 EVK board operation

6.4 Using PCA9955BTW-ARD with another device

The PCA9955BTW-ARD daughterboard can be operated with other EVK board, which has an Arduino port. There are two options to connect the board: using other EVK equipped with an Arduino port, and an EVK without Arduino port. In the first case, a firmware shall be developed according with PCA9955B specifications, and then simply attach PCA9955BTW-ARD daughterboard to the EVK, to operate the board. In the second case, using the pin chart of Arduino connectors ([Table 1](#)), make the necessary electrical connections (for power, I²C-bus and control lines), and develop the desired firmware, assuring that is compliant with IC specifications. Use PCA9955B datasheet to read details about internal registers of the DUT IC and data exchange between internal controller and the EVK. Assure for correct electrical connections and avoid data conflicts on the signal lines, to prevent IC damage.

7 GUI description

A GUI application is available for the three EVK boards from NXP Semiconductors. The application is common for all three EVKs described in [Section 6](#).

This section describes the GUI application and how the user can control the PCA9955BTW-ARD daughterboard from the graphical interface. First, install the GUI package and software on the PC (Windows 10). For more details, see [UM11581](#).

Once installation is complete, assure that one of the mentioned three EVK with attached PCA9955BTW-ARD daughterboard is connected to PC and powered-on. Open “NXP_GUI (PCA995x)” GUI application. An interface will appear as is shown in [Figure 11](#).

Note 2: Due to high complexity of the internal register map and functions of PCA9955B IC, for proper operation and testing of the daughterboard from GUI application, the user should read in detail the datasheet of PCA9955B IC.

7.1 Settings tab

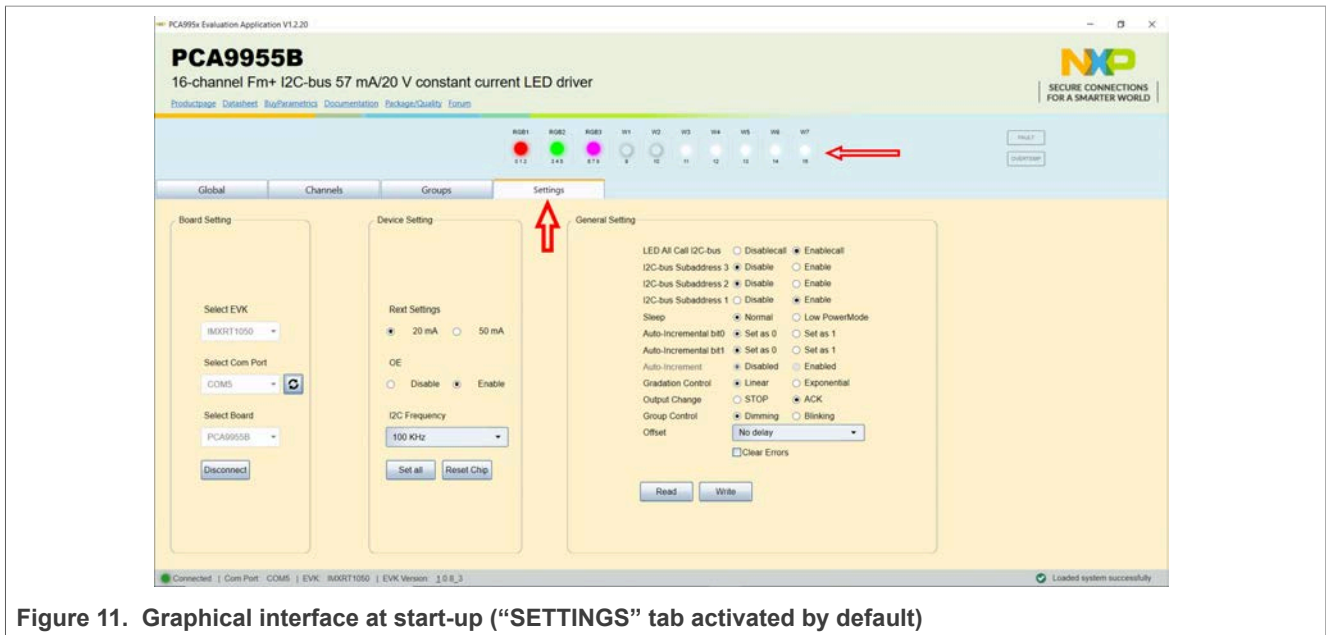

Figure 11. Graphical interface at start-up (“SETTINGS” tab activated by default)

The GUI application starts with **Settings** tab (marked in Figure 11 with red up arrow). In the right side of the blue region are located two read-only flags mapped in “MODE2” register (#01h). The **FAULT** flag indicates that the PCA9955BTW-ARD’s internal controller has detected an LED output error (no load, short). The **OVERTEMP** flag indicates that the PCA9955B die temperature exceeds its specified limit (see the PCA9955B datasheet, Section 7.3.15 “LED error detection” and Section 7.3.16 “Overtemperature protection”).

The LED indicators on the GUI are indicating the status of the on-board LEDs (marked in Figure 11 with red left arrow).

Below the LED indicators are three sections: **Board Setting** on the left, **Device Setting** in the middle, and **General Setting** on the right.

Board Setting parameters are:

- **Select EVK:** displays the list of EVKs. Selecting a wrong EVK board causes the connection to fail and a pop-up window with the message: “Unable to Connect with EVK” appears on the screen.
- **Select COM port:** displays port selected for the communication. The port is automatically selected by the system and is shown here as **COM5**.
- **Select Board:** allows the user to select the correct daughterboard (the application can support three different boards). In Figure 11 the selected board is **PCA9955B**.

Assuming the correct parameters are chosen, clicking the **Connect** button establishes the connection with the EVK. In the bottom side of the GUI window a status bar shows in real time the status regarding connection between PC and the EVK.

Device Setting parameters are:

- **REXT Settings** selects the maximum current delivered by the LED: 20 mA (default value) or 50 mA.
- **OE** controls the OE input of the DUT.
- **I2C Frequency** displays the I2C-bus clock frequency. The drop-down box allows the selection of three values: 100 kHz (default value), 400 kHz and 1 MHz.

Clicking the **Set all** button at the bottom of the section causes the selected values to be set in the DUT internal registers. Clicking **Reset Chip** returns the internal registers to their default values.

General Setting

The displayed parameters in the section, belongs to internal registers “MODE1” (00h), “MODE2” (01h), and “OFFSET” (3Fh). [Table 6](#) indicates the register address and bit level for each parameter under **General Settings** section. See the PCA9955B datasheet details regarding the “MODE1”, “MODE2”, and “OFFSET” registers.

Table 6. The parameters under the General Settings section

Parameter	Register name	Reg. addr. (HEX)	Bit	Symbol / Description	Remarks
LED All Call I2C-bus	MODE1	00h	0	ALLCALL	Read / Write
I2C-bus Subaddress 3	MODE1	00h	1	SUB3	Read / Write
I2C-bus Subaddress 2	MODE1	00h	2	SUB2	Read / Write
I2C-bus Subaddress 1	MODE1	00h	3	SUB1	Read / Write
Sleep	MODE1	00h	4	SLEEP	Read / Write
Auto-Incremental bit0	MODE1	00h	5	AI0	Read / Write
Auto-Incremental bit1	MODE1	00h	6	AI1	Read / Write
Auto-Increment	MODE1	00h	7	AIF	Read only
Gradation control	MODE2	01h	2	EXP_EN	Read / Write
Output Change	MODE2	01h	3	OCH	Read / Write
Group Control	MODE2	01h	5	DMBLNK	Read / Write
Offset	OFFSET	3Fh	7:4	Not Used	Read only
			3:0	LEDn out delay offset factor	Read / Write
Clear Errors	MODE2	01h	4	CLDERR	Write only

Set the values for each parameter and click the **Write** button to update the PCA9955B mode registers with the desired configuration. The **Read** button brings back the data from the mode register to GUI interface.

The status bar located in the bottom side of the interface, shows the connection status between the PC and the EVK.

7.2 Global

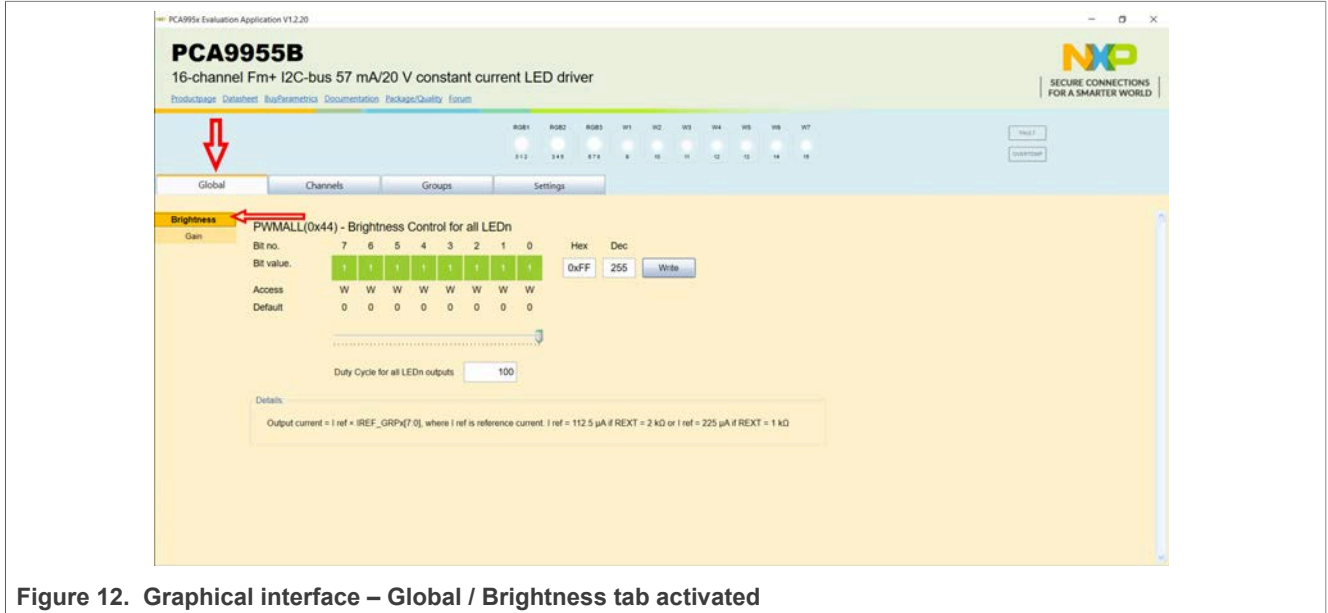

Figure 12. Graphical interface – Global / Brightness tab activated

The **Global** contains two secondary tabs. The default secondary tab is **Brightness** (see the red left arrows in [Figure 12](#)). The two secondary tabs sets the “PWMAL” (44h) and “IREFALL” (45h) internal registers of PCA9955B IC. The registers assure the overall control of the LEDs driven by the PCA9955B driver. The registers are 7-bit wide and can be set from the interface in four ways:

- Typing the hexadecimal value in the corresponding “Hex” box;
- Typing the decimal value in the corresponding “Dec” box;
- Setting each bit of the register with values of 0 and 1;
- Using the slider;

[Table 7](#) details the names and address of the registers:

Table 7. Secondary tabs under Global

Secondary tab	Picture in	Register name	Register address	Remarks
Brightness	Figure 12	PWMALL	#44h	Write only
Gain	Figure 13	IREFALL	#45h	Write only

The **Write** button send the value from the GUI to the internal registers of the DUT.

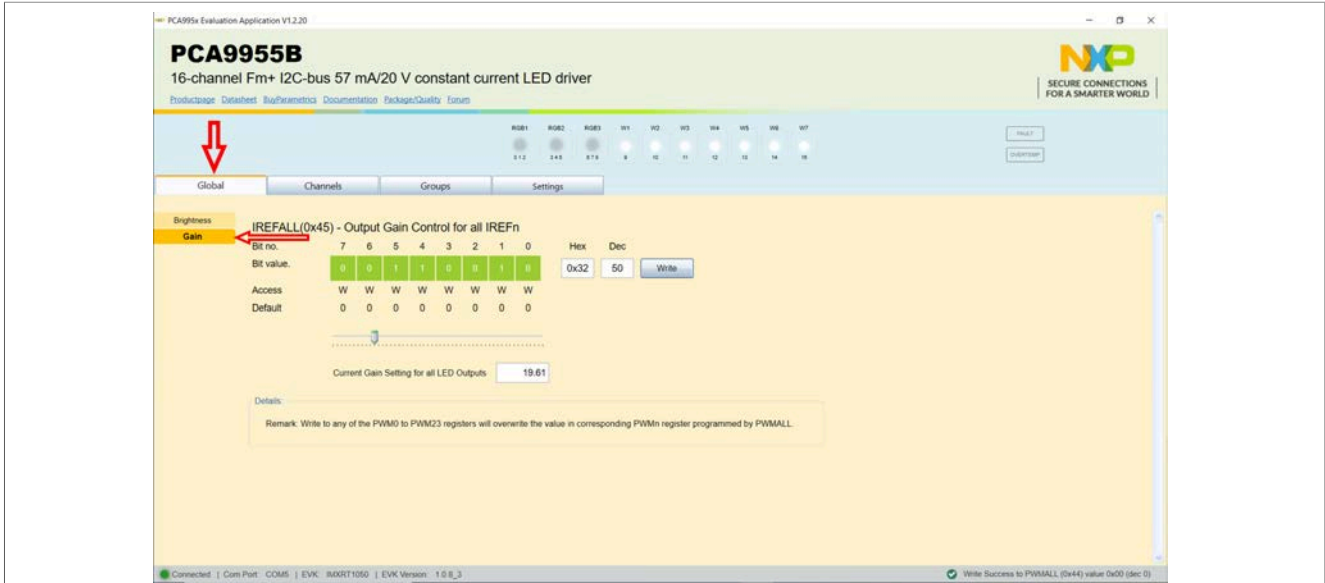

Figure 13. Graphical interface – Global / Gain tab activated

7.3 Channels tab

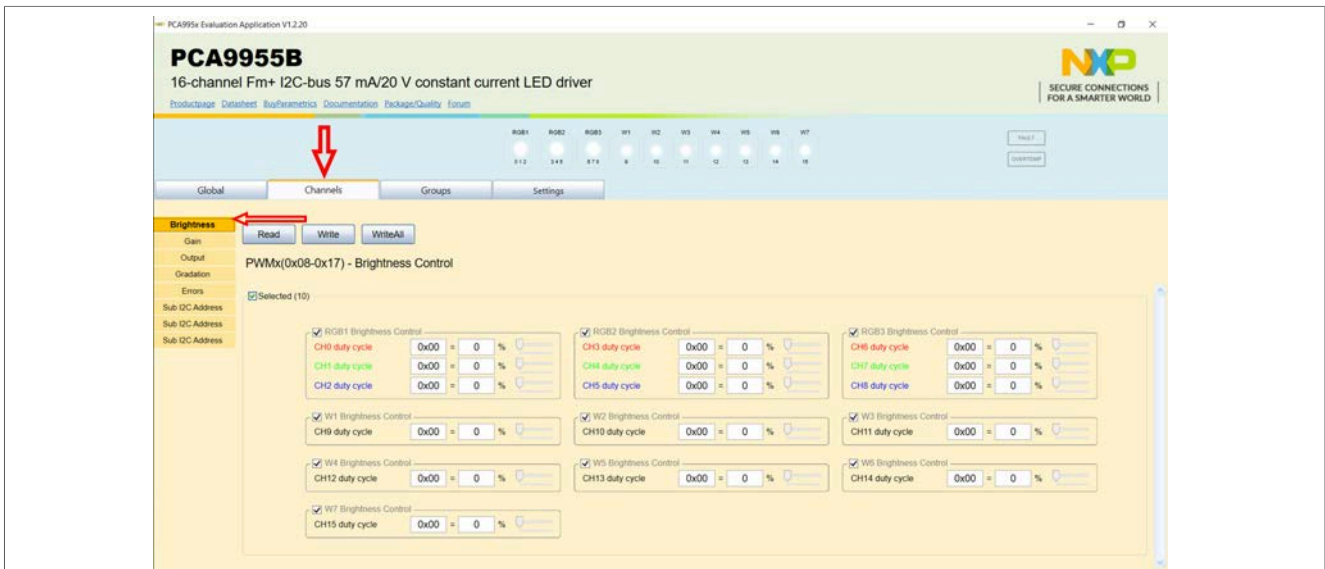

Figure 14. Graphical interface – Channels / Brightness tab activated

The **Channels** contains eight secondary tabs. The default secondary tab from **Channels** is **Brightness** (see the red left arrows in [Figure 14](#)). [Table 8](#) details the names and address of the registers. See the PCA9955B datasheet for more details about the internal registers which can be accessed from the **Channels** tab.

Table 8. Secondary tabs under Channels tab

Secondary tab	Picture in	Register name	Register HEX	Remarks
Brightness	Figure 14	PWM0 to PWM15	#08h – #17h	Read / Write / Write All
Gain	Figure 15	IREF0 to IREF15	#18h – #27h	Read / Write / Write All

Table 8. Secondary tabs under Channels tab...continued

Secondary tab	Picture in	Register name	Register HEX	Remarks
Output	Figure 16	LEDOUT0 to LEDOUT3	#02h – #05h	Read / Write / Write All
Gradation	Figure 17	GRADMODE_SEL0 GRADMODE_SEL1	#38h – #39h	Read / Write / Write All
Errors	Figure 18	EFLAG0 to EFLAG3	#46h – #49h	Read only
Sub I2C Address	Figure 19	SUBADR1 to SUBADR3	#40h – #43h	Read / Write

The **Write** button sets individually the new values from the GUI to the internal registers of the DUT. The **WriteAll** button sets globally the registers specified in [Table 8](#). The **Read** button brings back to the GUI the values from the PCA9955B registers to the graphical interface.

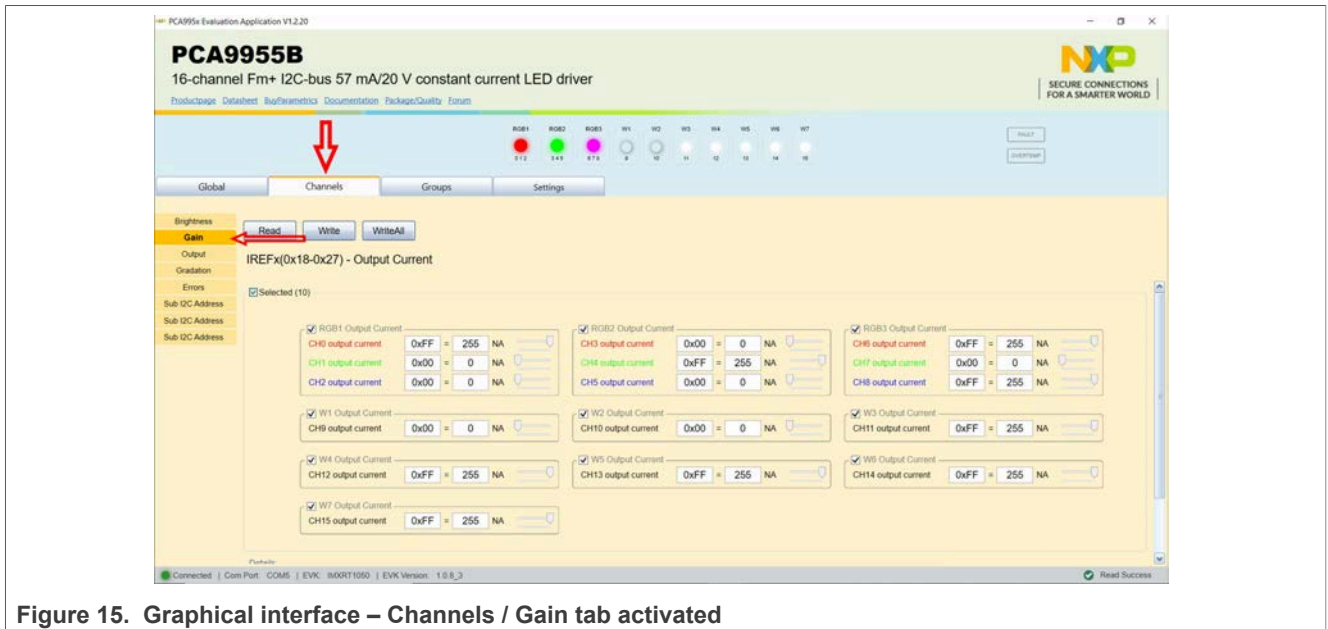

Figure 15. Graphical interface – Channels / Gain tab activated

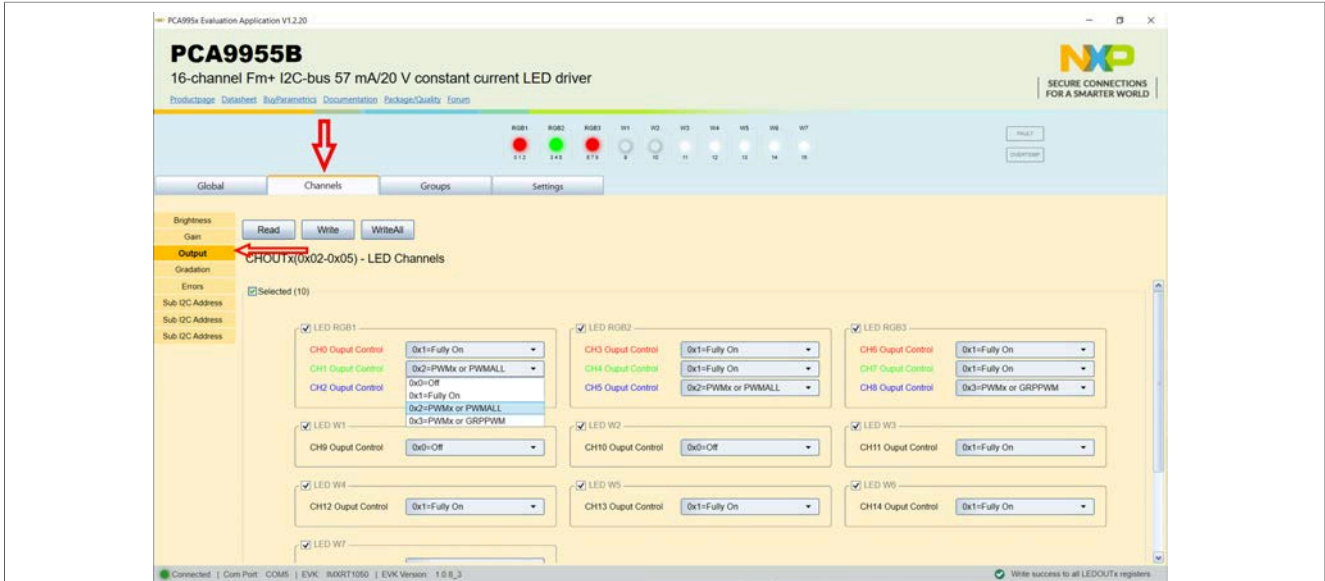

Figure 16. Graphical interface – Channels / Output tab activated

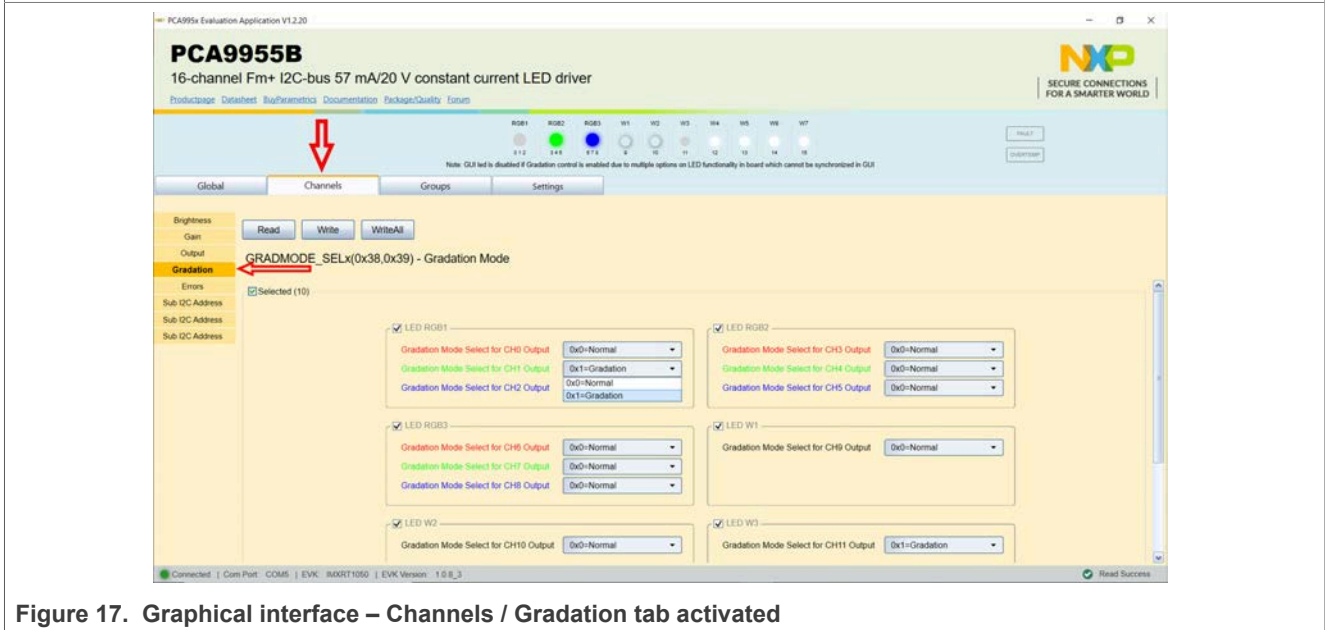

Figure 17. Graphical interface – Channels / Gradation tab activated

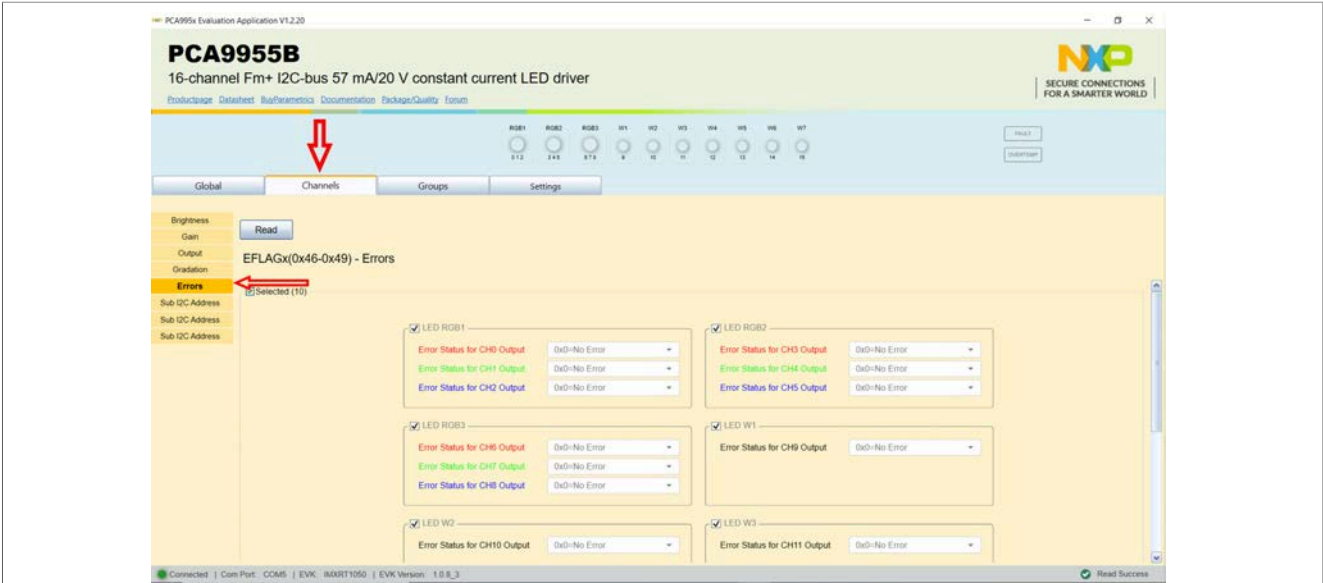

Figure 18. Graphical interface – Channels / Errors tab activated

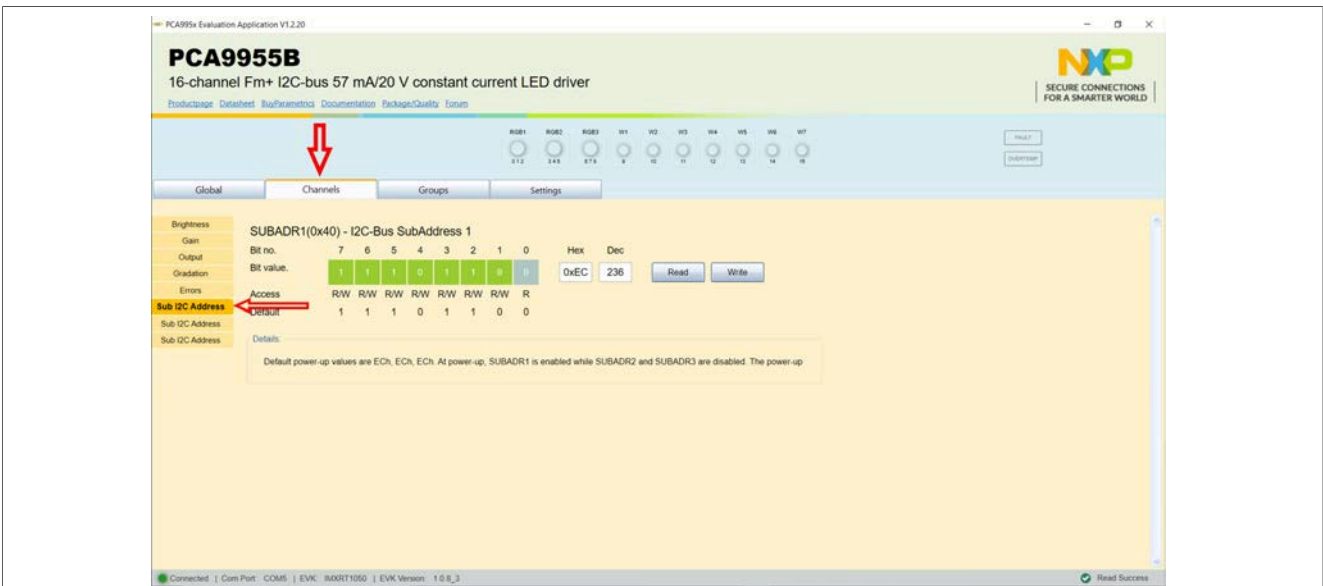

Figure 19. Graphical interface – Channels / Sub I2C Address tab activated

7.4 Groups tab

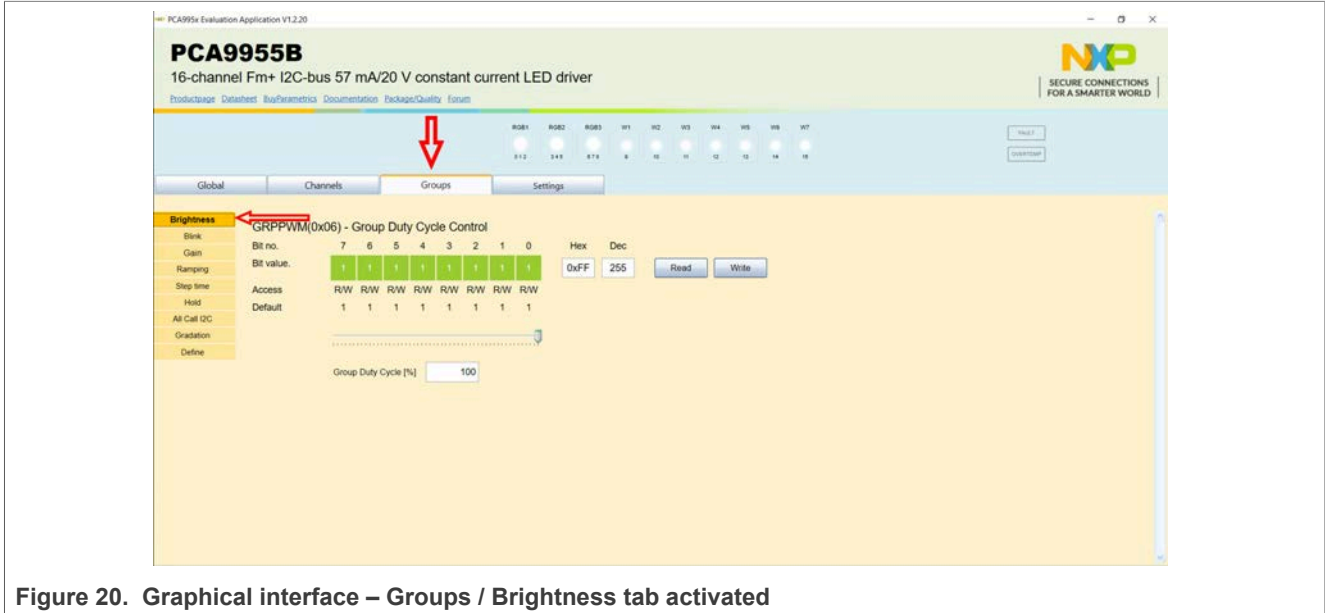

Figure 20. Graphical interface – Groups / Brightness tab activated

The **Groups** contains nine secondary tabs. The default secondary tab from **Channels** is **Brightness** (see the red left arrows in [Figure 20](#)). The secondary tabs set the internal registers of PCA9955B device for four user defined groups of channels. [Table 9](#) details the names and address of the registers. See the PCA9955B datasheet for more details about the internal registers which can be accessed from the **Channels** tab.

Table 9. Secondary tabs under Groups tab

Secondary tab	Picture in	Register name	Register HEX	Remarks
Brightness	Figure 20	GRPPWM	#06h	Read / Write
Blink	Figure 21	GRPFREQ	#07h	Read / Write
Gain	Figure 22	IREFGRP0 to IREFGR3	#2Bh, #2Fh, #33h, #37h	Read / Write
Ramping	Figure 23	RAMPRATE_GRPx	#28h, #2Ch, #30h, #34h	Read / Write
Step time	Figure 24	STEPTIME_GRPx	#29h, #2Dh, #31h, #35h	Read / Write
Hold	Figure 25	HOLDCNTL_GRPx	#2Ah, #2Eh, #32h, #36h	Read / Write
All Call I2C	Figure 26	ALLCALLADR	#43h	Read / Write
Gradation	Figure 27	GRADCNTL	#3Eh	Read / Write
Define	Figure 28	GRADGRP_SELx	#3Ah, #3Bh, #3Ch, #3Dh	Read / Write / Write All

The **Write** button sets individually the new values from the GUI to the internal registers of the DUT. The **WriteAll** button sets globally the registers specified in [Table 9](#). The **Read** button brings back to the GUI the values from the PCA9955B registers to the graphical interface.

The GUI application is reflecting the PCA9955B internal registers, therefore the user must fully understand the register map of the PCA9955B IC. In [Section 8](#) a set of instructions are provided, to help the user for quick check of the PCA9955BTW-ARD board and understanding how to write the registers of the PCA9955B IC.

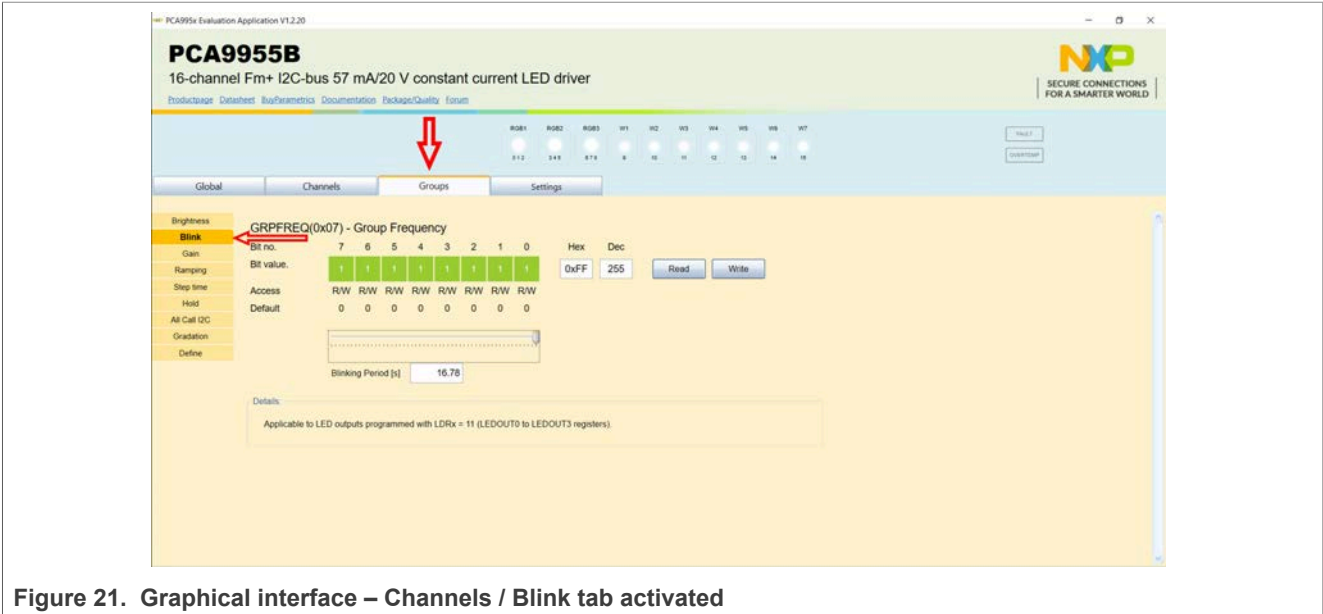

Figure 21. Graphical interface – Channels / Blink tab activated

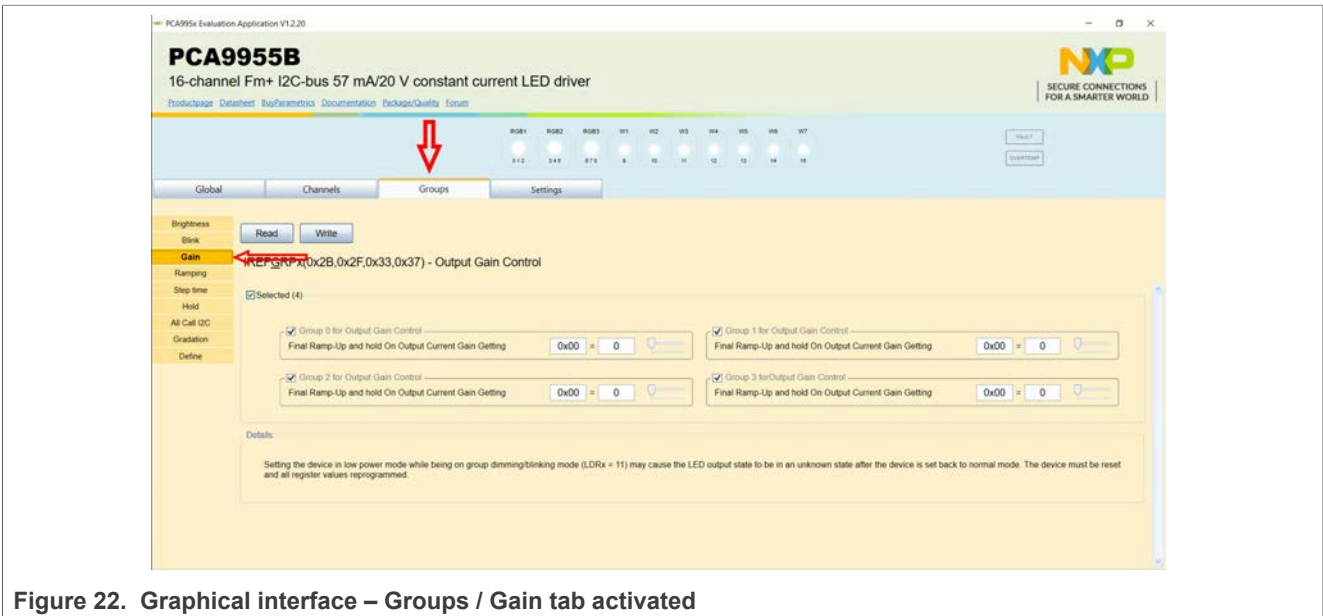

Figure 22. Graphical interface – Groups / Gain tab activated

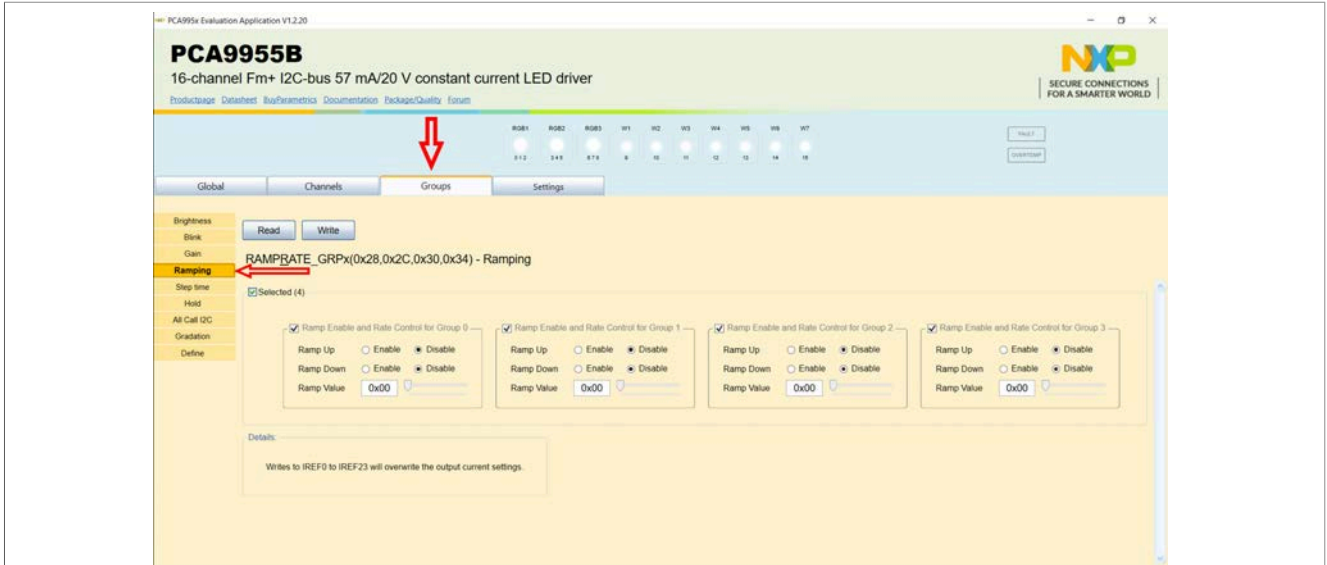

Figure 23. Graphical interface – Channels / Ramping tab activated

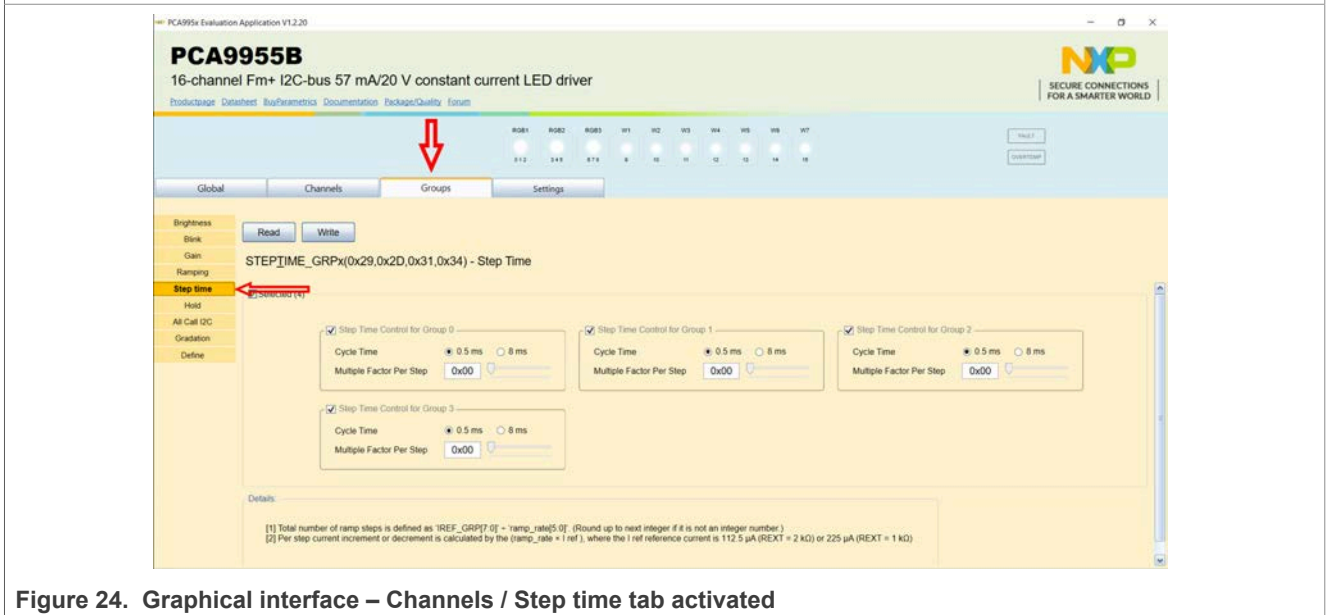

Figure 24. Graphical interface – Channels / Step time tab activated

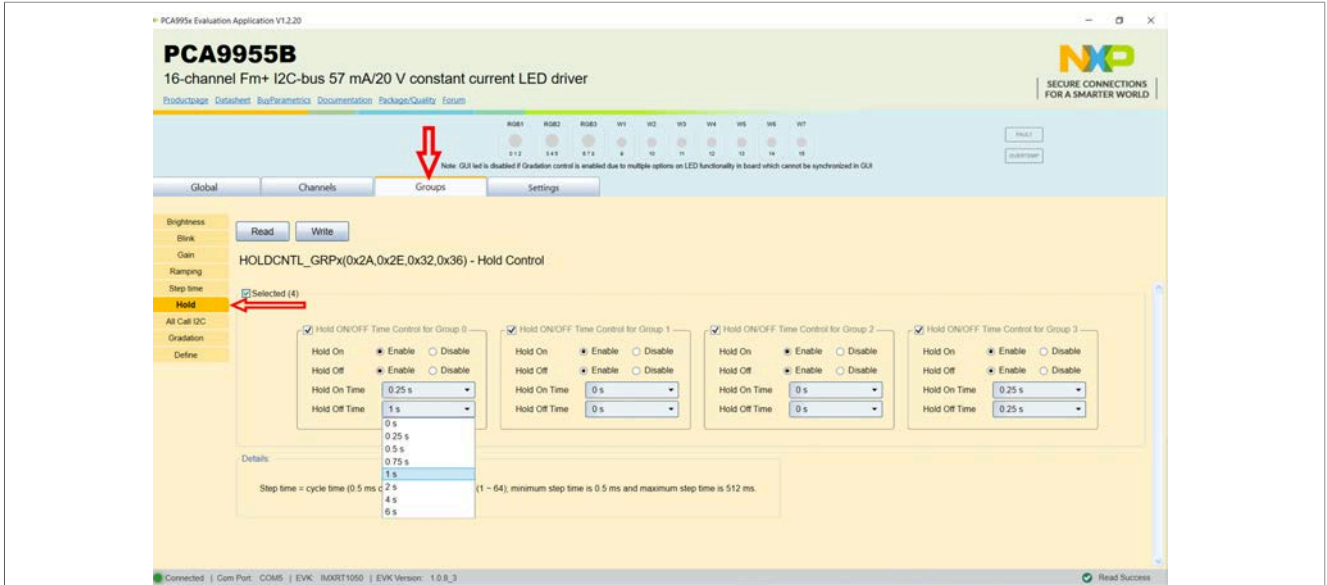

Figure 25. Graphical interface – Channels / Hold tab activated

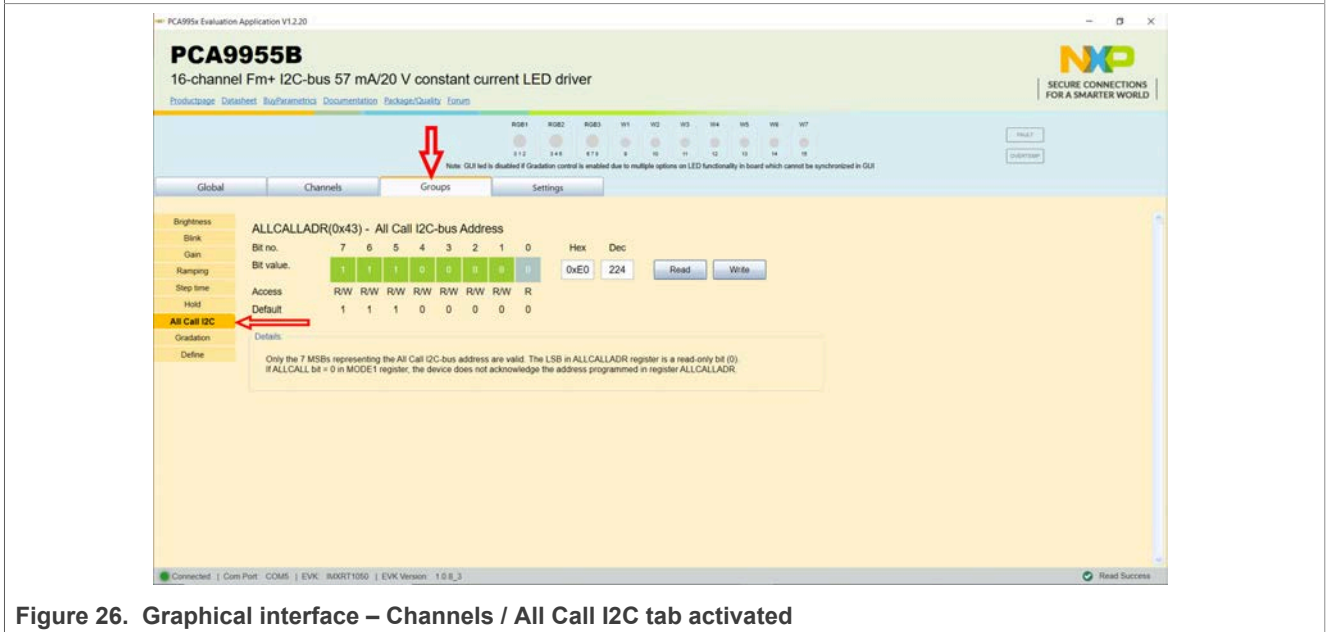

Figure 26. Graphical interface – Channels / All Call I2C tab activated

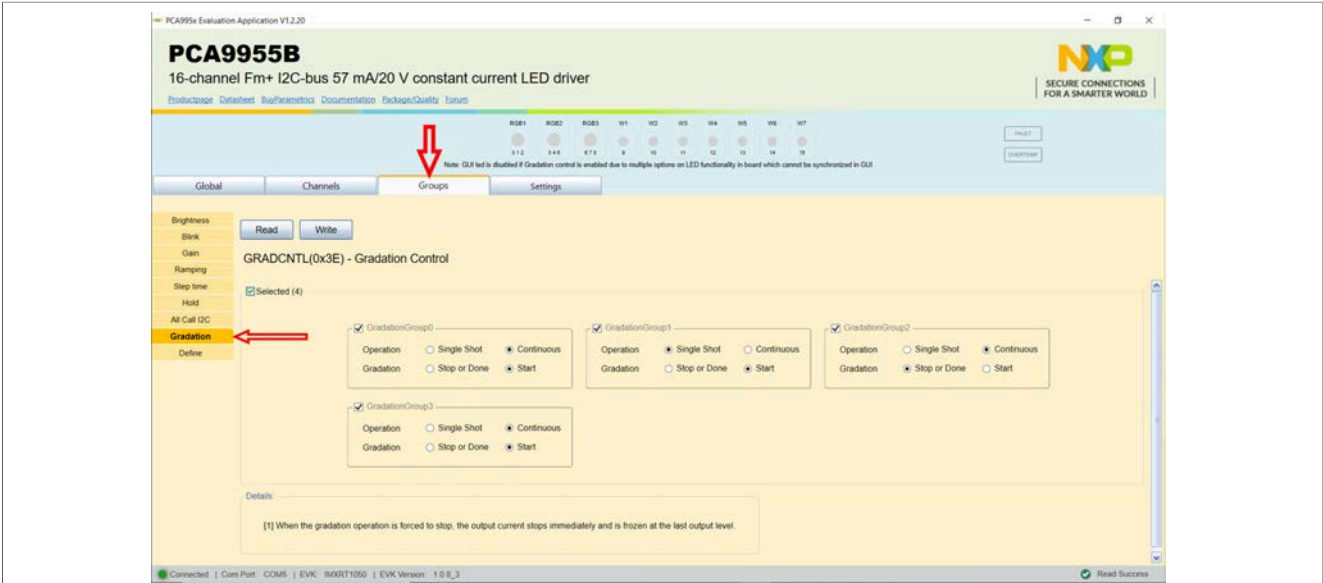

Figure 27. Graphical interface – Channels / Gradation tab activated

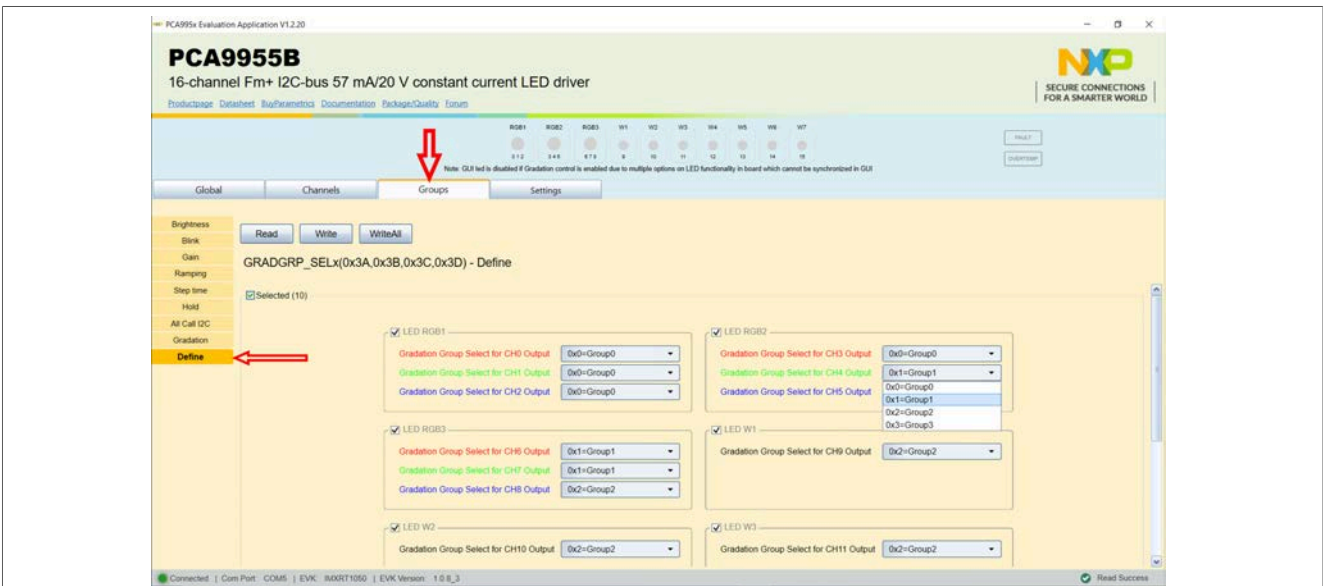

Figure 28. Graphical interface – Channels / Define tab activated

8 Operation example

This section details the necessary steps to operate the PCA9955BTW-ARD daughterboard with one of three EVKs from the GUI. This will help the user for a quick test of the board, and a guidance to understand the register functionality. After the hardware and GUI software was installed, follow the below steps, to turn on and off one or more LEDs, located on the PCA9955BTW-ARD daughterboard:

1. Open the “NXP_GUI (PCA995x)” application on the PC.
2. In the Board Setting section, from Select EVK list, select the EVK used in the setup.

3. From Select COM Port list, select the correct COM (if more than one is available).
4. From Select Board list, select PCA9955B.
5. Click **Connect**. When the connection is established, all on-board LEDs are turned on.
6. From Device Setting list, Select **Disable** for the **OE**, and click **Set all** button. This will disable the driver outputs (the LEDs turns off).
7. Select **Channels** tab. From here, select Brightness secondary tab. Set the duty cycle for “CH2” – RGB1 blue, “CH4” – RGB2 green, and “CH6” – RGB red to 100%. Press **Write** button to set the individual selected values.
8. From the same tab, select **Output** secondary tab. Select for “CH0 Output Control” the value **0x3=PWMx or GRPPWM**. Press **WriteAll** button to set the same value for all channels.
9. Select **Gradation** secondary tab, select for Gradation Mode Select for CH0 Output the gradation mode **0x1=Gradation**. Press **WriteAll** button to set the same value for all channels.
10. Select **Groups** tab, and **Brightness** secondary tab. Set the “Group Duty Cycle” to 100%. Press **Write** button to set the selected value.
11. Select **Gain** secondary tab. Set for “Group 0” the Output Current Gain the value 255. Press **Write** button to set the selected value.
12. Select **Hold** secondary tab. For “Hold ON/OFF Time Control for Group 0” set the following values: **Enable** for **Hold On** and **Hold Off**, and any value which is different from “0 s” for **Hold On Time** and **Hold Of Time**. Press **Write** button to set the selected values.
13. Select **Gradation** secondary tab. For “GradationGroup0” set the following values: **Continuous** for **Operation** and **Start** for **Gradation**. Press **Write** button to set the selected values.
14. Select **Define** secondary tab. For “Gradation Group Select for CH0 Output” select the value **0x0=Group0**. Press **WriteAll** button to set the same value to all channels.
15. Go back to the **Settings** tab, select **Enable** for **OE** and click **Set all** button. The selected group of LEDs will turn on and off, with the intensity according with the previous settings.
16. Select again the **Groups** tab. Select **Gradation** secondary tab. For “Ramp Enable and Rate Control for Group 0” select the following values: **Enable** for **Ramp Up** and **Ramp Down**, and any value but different from “0x00” for **Ramp Value**. Press **Write** button to set the selected values.
17. Select **Step time** secondary tab. For “Step Time Control for Group 0” select **8 ms** for **Cycle Time**. Press **Write** button to set the selected values.

Starting from these steps and using the datasheet, the user can combine different values for the internal registers of the DUT, to understand, and test the functionality of the PCA9955B LED driver.

9 Abbreviations

Table 10. Abbreviations

Acronym	Description
DUT	Device Under Test
ESD	Electro Static Discharge
EVK	Evaluation Board
GUI	Graphical User Interface

Table 10. Abbreviations...continued

Acronym	Description
I ² C bus	Inter-Integrated Circuit bus
IC	Integrated Circuit
I/O	Input / Output
LED	Light Emitting Diode
PC	Personal Computer
USB	Universal Serial Bus

10 References

1. *PCA9955B – 16-channel Fm+ I2C-bus 57 mA/20 V constant current LED driver*
Product data sheet; NXP Semiconductors;
2. *MIMxrt1050 EVK Board Hardware User's Guide*
User manual; NXP Semiconductors;
3. *i.MX RT1050 Crossover Processors Data Sheet for Consumer Products*
Data sheet; NXP Semiconductors;
4. *UM11158 – LPCXpresso55S69 Development Board*
User manual; NXP Semiconductors;
5. *i.MX 8M Mini LPDDR4 EVK Board Hardware User's Guide*
User guide; NXP Semiconductors;
6. *i.MX 8M Mini Application Processor Datasheet for Consumer Products*
Data sheet; NXP Semiconductors;
7. *i.MX 8M Mini Application Processor Reference Manual*
Reference manual; NXP Semiconductors;
8. *Arduino Uno R3 Reference Manual*
Reference manual; NXP Semiconductors;
9. *IMX8MMINI-IARD interposer board User Manual*
User manual; NXP Semiconductors;
10. *Arduino Shields GUI and firmware installation*
User manual; NXP Semiconductors

11 Legal information

11.1 Definitions

Draft — A draft status on a document indicates that the content is still under internal review and subject to formal approval, which may result in modifications or additions. NXP Semiconductors does not give any representations or warranties as to the accuracy or completeness of information included in a draft version of a document and shall have no liability for the consequences of use of such information.

11.2 Disclaimers

Limited warranty and liability — Information in this document is believed to be accurate and reliable. However, NXP Semiconductors does not give any representations or warranties, expressed or implied, as to the accuracy or completeness of such information and shall have no liability for the consequences of use of such information. NXP Semiconductors takes no responsibility for the content in this document if provided by an information source outside of NXP Semiconductors.

In no event shall NXP Semiconductors be liable for any indirect, incidental, punitive, special or consequential damages (including - without limitation - lost profits, lost savings, business interruption, costs related to the removal or replacement of any products or rework charges) whether or not such damages are based on tort (including negligence), warranty, breach of contract or any other legal theory.

Notwithstanding any damages that customer might incur for any reason whatsoever, NXP Semiconductors' aggregate and cumulative liability towards customer for the products described herein shall be limited in accordance with the Terms and conditions of commercial sale of NXP Semiconductors.

Right to make changes — NXP Semiconductors reserves the right to make changes to information published in this document, including without limitation specifications and product descriptions, at any time and without notice. This document supersedes and replaces all information supplied prior to the publication hereof.

Suitability for use — NXP Semiconductors products are not designed, authorized or warranted to be suitable for use in life support, life-critical or safety-critical systems or equipment, nor in applications where failure or malfunction of an NXP Semiconductors product can reasonably be expected to result in personal injury, death or severe property or environmental damage. NXP Semiconductors and its suppliers accept no liability for inclusion and/or use of NXP Semiconductors products in such equipment or applications and therefore such inclusion and/or use is at the customer's own risk.

Applications — Applications that are described herein for any of these products are for illustrative purposes only. NXP Semiconductors makes no representation or warranty that such applications will be suitable for the specified use without further testing or modification.

Customers are responsible for the design and operation of their applications and products using NXP Semiconductors products, and NXP Semiconductors accepts no liability for any assistance with applications or customer product design. It is customer's sole responsibility to determine whether the NXP Semiconductors product is suitable and fit for the customer's applications and products planned, as well as for the planned application and use of customer's third party customer(s). Customers should provide appropriate design and operating safeguards to minimize the risks associated with their applications and products.

NXP Semiconductors does not accept any liability related to any default, damage, costs or problem which is based on any weakness or default in the customer's applications or products, or the application or use by customer's third party customer(s). Customer is responsible for doing all necessary testing for the customer's applications and products using NXP Semiconductors products in order to avoid a default of the applications and the products or of the application or use by customer's third party customer(s). NXP does not accept any liability in this respect.

Terms and conditions of commercial sale — NXP Semiconductors products are sold subject to the general terms and conditions of commercial sale, as published at <http://www.nxp.com/profile/terms>, unless otherwise agreed in a valid written individual agreement. In case an individual agreement is concluded only the terms and conditions of the respective agreement shall apply. NXP Semiconductors hereby expressly objects to applying the customer's general terms and conditions with regard to the purchase of NXP Semiconductors products by customer.

Export control — This document as well as the item(s) described herein may be subject to export control regulations. Export might require a prior authorization from competent authorities.

Suitability for use in non-automotive qualified products — Unless this data sheet expressly states that this specific NXP Semiconductors product is automotive qualified, the product is not suitable for automotive use. It is neither qualified nor tested in accordance with automotive testing or application requirements. NXP Semiconductors accepts no liability for inclusion and/or use of non-automotive qualified products in automotive equipment or applications.

In the event that customer uses the product for design-in and use in automotive applications to automotive specifications and standards, customer (a) shall use the product without NXP Semiconductors' warranty of the product for such automotive applications, use and specifications, and (b) whenever customer uses the product for automotive applications beyond NXP Semiconductors' specifications such use shall be solely at customer's own risk, and (c) customer fully indemnifies NXP Semiconductors for any liability, damages or failed product claims resulting from customer design and use of the product for automotive applications beyond NXP Semiconductors' standard warranty and NXP Semiconductors' product specifications.

Translations — A non-English (translated) version of a document, including the legal information in that document, is for reference only. The English version shall prevail in case of any discrepancy between the translated and English versions.

Security — Customer understands that all NXP products may be subject to unidentified vulnerabilities or may support established security standards or specifications with known limitations. Customer is responsible for the design and operation of its applications and products throughout their lifecycles to reduce the effect of these vulnerabilities on customer's applications and products. Customer's responsibility also extends to other open and/or proprietary technologies supported by NXP products for use in customer's applications. NXP accepts no liability for any vulnerability. Customer should regularly check security updates from NXP and follow up appropriately. Customer shall select products with security features that best meet rules, regulations, and standards of the intended application and make the ultimate design decisions regarding its products and is solely responsible for compliance with all legal, regulatory, and security related requirements concerning its products, regardless of any information or support that may be provided by NXP.

NXP has a Product Security Incident Response Team (PSIRT) (reachable at PSIRT@nxp.com) that manages the investigation, reporting, and solution release to security vulnerabilities of NXP products.

11.3 Trademarks

Notice: All referenced brands, product names, service names, and trademarks are the property of their respective owners.

NXP — wordmark and logo are trademarks of NXP B.V.

Tables

Tab. 1.	I2C target address chart	7	Tab. 6.	The parameters under the General Settings section	22
Tab. 2.	The pin chart of Arduino connectors and their usage	9	Tab. 7.	Secondary tabs under Global	23
Tab. 3.	The expansion connector J45 / J89 pin chart	11	Tab. 8.	Secondary tabs under Channels tab	24
Tab. 4.	PCA9955BTW-ARD jumpers	11	Tab. 9.	Secondary tabs under Groups tab	28
Tab. 5.	PCA9955BTW-ARD test points	13	Tab. 10.	Abbreviations	33

Figures

Fig. 1.	PCA9955BTW-ARD arduino board: top view (up) and bottom view (down)	6	Fig. 15.	Graphical interface – Channels / Gain tab activated	25
Fig. 2.	PCA9955BTW-ARD block diagram	7	Fig. 16.	Graphical interface – Channels / Output tab activated	26
Fig. 3.	PCA9955BTW-ARD chain configuration	11	Fig. 17.	Graphical interface – Channels / Gradation tab activated	26
Fig. 4.	PCA9955BTW-ARD Jumper locations	13	Fig. 18.	Graphical interface – Channels / Errors tab activated	27
Fig. 5.	PCA9955BTW-ARD daughterboard and IMXRT1050 EVK board, before starting	15	Fig. 19.	Graphical interface – Channels / Sub I2C Address tab activated	27
Fig. 6.	The assembly PCA9955BTW-ARD daughterboard / IMXRT1050 EVK board operation	16	Fig. 20.	Graphical interface – Groups / Brightness tab activated	28
Fig. 7.	PCA9955BTW-ARD daughterboard and LPCXpresso55S69 motherboard, before starting	17	Fig. 21.	Graphical interface – Channels / Blink tab activated	29
Fig. 8.	PCA9955BTW-ARD daughterboard / LPCXpresso55S69 motherboard operation	18	Fig. 22.	Graphical interface – Groups / Gain tab activated	29
Fig. 9.	The assembly PCA9955BTW-ARD daughterboard, IMX8MMINI-IARD interposer board, and i.MX 8M Mini LPDDR4 EVK, before starting	19	Fig. 23.	Graphical interface – Channels / Ramping tab activated	30
Fig. 10.	PCA9955BTW-ARD daughterboard / i.MX 8M Mini LPDDR4 EVK board operation	20	Fig. 24.	Graphical interface – Channels / Step time tab activated	30
Fig. 11.	Graphical interface at start-up (“SETTINGS” tab activated by default)	21	Fig. 25.	Graphical interface – Channels / Hold tab activated	31
Fig. 12.	Graphical interface – Global / Brightness tab activated	23	Fig. 26.	Graphical interface – Channels / All Call I2C tab activated	31
Fig. 13.	Graphical interface – Global / Gain tab activated	24	Fig. 27.	Graphical interface – Channels / Gradation tab activated	32
Fig. 14.	Graphical interface – Channels / Brightness tab activated	24	Fig. 28.	Graphical interface – Channels / Define tab activated	32

Contents

1	Introduction	4
2	Finding kit resources and information on the NXP web site	4
2.1	Collaborate in the NXP community	4
3	Getting ready	4
3.1	Kit contents	5
3.2	Assumptions	5
3.3	Static handling requirements	5
3.4	Minimum system requirements	5
4	Getting to know the hardware	5
4.1	PCA9955BTW-ARD features	5
4.2	Kit featured components	6
4.3	Schematic diagram	6
4.4	General description	6
4.5	Arduino port	9
4.6	Power distribution	10
4.7	Chain configuration	10
4.8	Jumpers and test points	11
5	Installing and configuring software tools	14
6	Configuring the hardware	14
6.1	Using the PCA9955BTW-ARD with an IMXRT1050 EVK board	14
6.2	Using the PCA9955BTW-ARD with an LPCXpresso55S69 development board	16
6.3	Using the PCA9955BTW-ARD with an i.MX 8M Mini LPDDR4 EVK board	18
6.4	Using PCA9955BTW-ARD with another device	20
7	GUI description	20
7.1	Settings tab	21
7.2	Global	23
7.3	Channels tab	24
7.4	Groups tab	28
8	Operation example	32
9	Abbreviations	33
10	References	35
11	Legal information	36

Please be aware that important notices concerning this document and the product(s) described herein, have been included in section 'Legal information'.
