

DM74ALS244A Octal 3-STATE Bus Driver

General Description

This octal 3-STATE bus driver is designed to provide the designer with flexibility in implementing a bus interface with memory, microprocessor, or communication systems. This device offers 64-extended temperature Grade product guaranteeing performance from -40°C to $+85^{\circ}\text{C}$. The output 3-STATE gating control is organized into two separate groups of four buffers, and both control inputs enable the respective outputs when set logic LOW. The 3-STATE circuitry contains a feature that maintains the buffer outputs in 3-STATE (high impedance state) during power supply ramp-up or ramp-down. This eliminates bus glitching problems that arise during power-up and power-down.

Features

- Advanced low power oxide-isolated ion-implanted Schottky TTL process
- Functional and pin compatible with the 74LS counterpart
- Improved switching performance with less power dissipation compared with the 74LS counterpart
- Switching response specified into 500Ω and 50 pF load
- Switching response specifications guaranteed over full temperature and V_{CC} supply range
- PNP input design reduces input loading

Ordering Code:

Order Number	Package Number	Package Description
DM74ALS244AWM	M20B	20-Lead Small Outline Integrated Circuit (SOIC), JEDEC MS-013, 0.300 Wide
DM74ALS244ASJ	M20D	20-Lead Small Outline Package (SOP), EIAJ TYPE II, 5.3mm Wide
DM74ALS244AMSA	MSA20	20-Lead Shrink Small Outline Package (SSOP), EIAJ TYPE II, 5.3mm Wide
DM74ALS244AN	N20A	20-Lead Plastic Dual-In-Line Package (PDIP), JEDEC MS-001, 0.300 Wide

Devices also available in Tape and Reel. Specify by appending the suffix letter "X" to the ordering code.

Connection Diagram

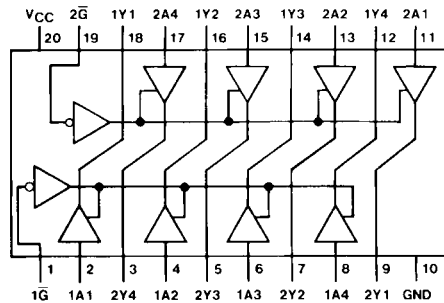

Logic Diagram

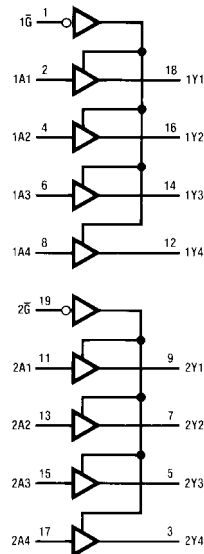

Function Table

Input		Output
$\overline{\text{G}}$	A	Y
L	L	L
L	H	H
H	X	Z

H = HIGH Level Logic State
L = LOW Level Logic State
X = Don't Care (Either LOW or HIGH Level Logic State)
Z = High Impedance (OFF) State

Absolute Maximum Ratings(Note 1)

Supply Voltage, V_{CC}	7V
Input Voltage	7V
Voltage Applied to Disabled Output	5.5V
Operating Free Air Temperature Range	0°C to +70°C
Storage Temperature Range	-65°C to +150°C
Typical θ_{JA}	
N Package	60.5°C/W
M Package	79.8°C/W

Note 1: The "Absolute Maximum Ratings" are those values beyond which the safety of the device cannot be guaranteed. The device should not be operated at these limits. The parametric values defined in the Electrical Characteristics tables are not guaranteed at the absolute maximum ratings. The "Recommended Operating Conditions" table will define the conditions for actual device operation.

Recommended Operating Conditions

Symbol	Parameter	Min	Typ	Max	Units
V_{CC}	Supply Voltage	4.5	5	5.5	V
V_{IH}	HIGH Level Input Voltage	2			V
V_{IL}	LOW Level Input Voltage			0.8	V
I_{OH}	HIGH Level Output Current			-15	mA
I_{OL}	LOW Level Output Current			24	mA
T_A	Operating Free-Air Temperature	0		70	°C

Electrical Characteristics

over recommended operating free air temperature (unless otherwise specified)

Symbol	Parameter	Conditions	Min	Typ	Max	Units
V_{IK}	Input Clamp Voltage	$V_{CC} = 4.5V, I_I = -18 \text{ mA}$			-1.5	V
V_{OH}	HIGH Level Output Voltage	$V_{CC} = 4.5V \text{ to } 5.5V$	$I_{OH} = -0.4 \text{ mA}$	$V_{CC}-2$		V
		$V_{CC} = 4.5V$	$I_{OH} = -3 \text{ mA}$	2.4		V
			$I_{OH} = \text{Max}$	2		V
V_{OL}	LOW Level Output Voltage	$V_{CC} = 4.5V$		0.35	0.5	V
		$I_{OL} = 24 \text{ mA}$				
I_I	Input Current at Maximum Input Voltage	$V_{CC} = 5.5V, V_I = 7V$			0.1	mA
I_{IH}	HIGH Level Input Current	$V_{CC} = 5.5V, V_I = 2.7V$			20	μA
I_{IL}	LOW Level Input Current	$V_{CC} = 5.5V, V_{IL} = 0.4V$			-0.1	mA
I_O	Output Drive Current	$V_{CC} = 5.5V, V_O = 2.25V$	-30		-112	mA
I_{OZH}	HIGH Level 3-STATE Output Current	$V_{CC} = 5.5V, V_O = 2.7V$			20	μA
I_{OZL}	LOW Level 3-STATE Output Current	$V_{CC} = 5.5V, V_O = 0.4V$			-20	μA
I_{CC}	Supply Current	$V_{CC} = 5.5V$		9	15	mA
		Outputs HIGH				
		Outputs LOW		15	24	mA
		Outputs 3-STATE		17	27	mA

Switching Characteristics

over recommended operating free-air temperature range

Symbol	Parameter	Conditions	From (Input)	To (Output)	Min	Max	Units
t_{PLH}	Propagation Delay Time LOW-to-HIGH Level Output	$V_{CC} = 4.5V \text{ to } 5.5V,$ $C_L = 50 \text{ pF},$ $R1 = 500\Omega,$ $R2 = 500\Omega,$ $T_A = \text{Min to Max}$	A	Y	3	10	ns
t_{PHL}	Propagation Delay Time HIGH-to-LOW Level Output		A	Y	3	10	ns
t_{PZH}	Output Enable Time to HIGH Level Output		\bar{G}	Y	3	20	ns
t_{PZL}	Output Enable Time to LOW Level Output		\bar{G}	Y	3	20	ns
t_{PHZ}	Output Disable Time from HIGH Level Output		\bar{G}	Y	2	10	ns
t_{PLZ}	Output Disable Time from LOW Level Output		\bar{G}	Y	1	13	ns

Physical Dimensions inches (millimeters) unless otherwise noted (Continued)

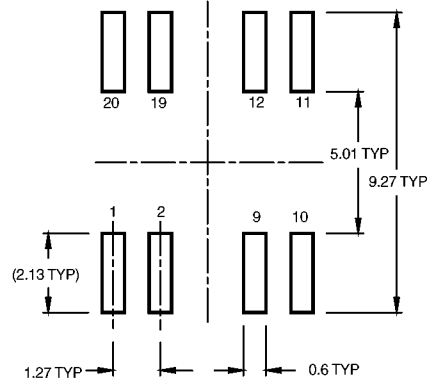
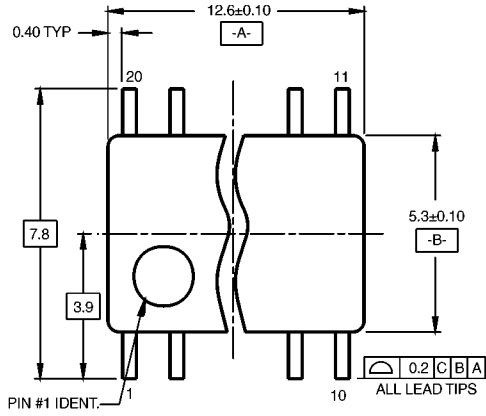

LAND PATTERN RECOMMENDATION

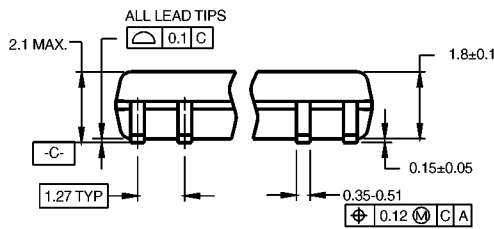

DIMENSIONS ARE IN MILLIMETERS

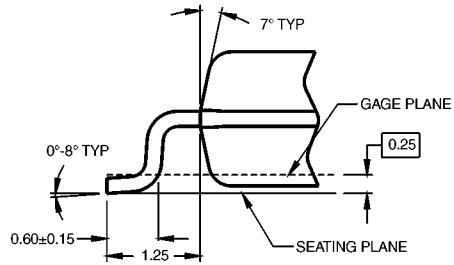
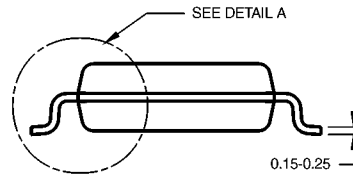

DETAIL A

- NOTES:
- A. CONFORMS TO EIAJ EDR-7320 REGISTRATION, ESTABLISHED IN DECEMBER, 1998.
 - B. DIMENSIONS ARE IN MILLIMETERS.
 - C. DIMENSIONS ARE EXCLUSIVE OF BURRS, MOLD FLASH, AND TIE BAR EXTRUSIONS.

M20DRevB1

20-Lead Small Outline Integrated Circuit (SOIC), JEDEC MS-013, 0.300 Wide Package Number M20D

Physical Dimensions inches (millimeters) unless otherwise noted (Continued)

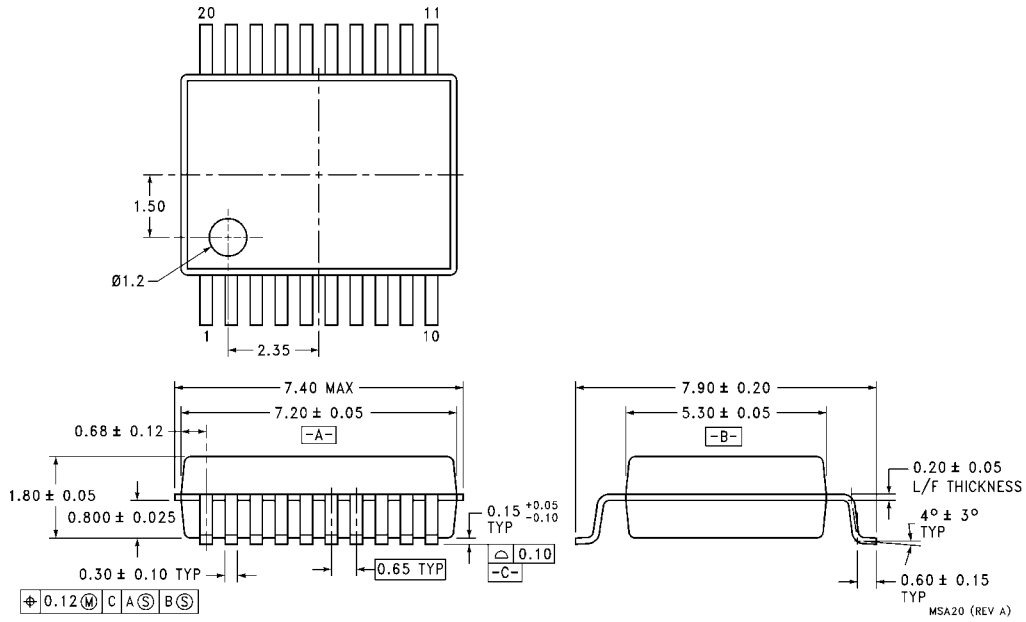

Physical Dimensions inches (millimeters) unless otherwise noted (Continued)

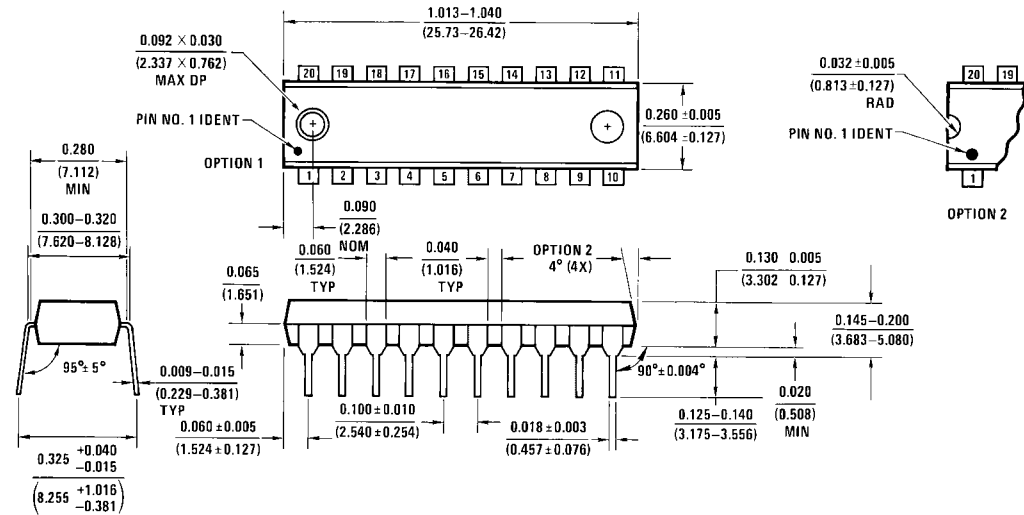

20-Lead Plastic Dual-In-Line Package (PDIP), JEDEC MS-001, 0.300 Wide Package Number N20A

Fairchild does not assume any responsibility for use of any circuitry described, no circuit patent licenses are implied and Fairchild reserves the right at any time without notice to change said circuitry and specifications.

LIFE SUPPORT POLICY

FAIRCHILD'S PRODUCTS ARE NOT AUTHORIZED FOR USE AS CRITICAL COMPONENTS IN LIFE SUPPORT DEVICES OR SYSTEMS WITHOUT THE EXPRESS WRITTEN APPROVAL OF THE PRESIDENT OF FAIRCHILD SEMICONDUCTOR CORPORATION. As used herein:

1. Life support devices or systems are devices or systems which, (a) are intended for surgical implant into the body, or (b) support or sustain life, and (c) whose failure to perform when properly used in accordance with instructions for use provided in the labeling, can be reasonably expected to result in a significant injury to the user.
2. A critical component in any component of a life support device or system whose failure to perform can be reasonably expected to cause the failure of the life support device or system, or to affect its safety or effectiveness.

www.fairchildsemi.com