

74LCXH2245

Low Voltage Bidirectional Transceiver with Bushold and 26Ω Series Resistors in B Outputs

General Description

The LCXH2245 contains eight non-inverting bidirectional buffers with 3-STATE outputs and is intended for bus oriented applications. The device is designed for low voltage (2.5V and 3.3V) V_{CC} applications. The T/\bar{R} input determines the direction of data flow through the device. The \overline{OE} input disables both the A and B ports by placing them in a high impedance state. The 26Ω series resistor in the B Port output helps reduce output overshoot and undershoot.

The LCXH2245 is fabricated with an advanced CMOS technology to achieve high speed operation while maintaining CMOS low power dissipation.

The LCXH2245 data inputs include active bushold circuitry, eliminating the need for external pull-up resistors to hold unused or floating data inputs at a valid logic level.

Features

- 5V tolerant control inputs
- 2.3V–3.6V V_{CC} specifications provided
- Bushold on inputs eliminates the need for external pull-up/pull-down resistors
- 7.0 ns t_{PD} max ($V_{CC} = 3.3V$), 10 μA I_{CC} max
- Power down high impedance outputs
- ± 12 mA output drive B Port ($V_{CC} = 3.0V$)
- Implements patented noise/EMI reduction circuitry
- Latch-up performance exceeds 500 mA
- Equivalent 26Ω series resistor on B Port outputs
- ESD performance:
 - Human body model > 2000V
 - Machine model > 200V

Ordering Code:

Order Number	Package Number	Package Description
74LCXH2245WM	M20B	20-Lead Small Outline Integrated Circuit (SOIC), JEDEC MS-013, 0.300" Wide
74LCXH2245SJ	M20D	Pb-Free 20-Lead Small Outline Package (SOP), EIAJ TYPE II, 5.3mm Wide
74LCXH2245MSA	MSA20	20-Lead Shrink Small Outline Package (SSOP), JEDEC MO-150, 5.3mm Wide
74LCXH2245MTC	MTC20	20-Lead Thin Shrink Small Outline Package (TSSOP), JEDEC MO-153, 4.4mm Wide

Devices also available in Tape and Reel. Specify by appending the suffix letter "X" to the ordering code.
Pb-Free package per JEDEC J-STD-020B.

Logic Symbol

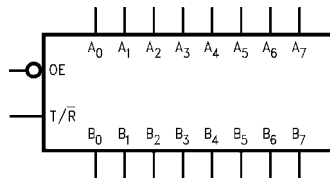

Connection Diagram

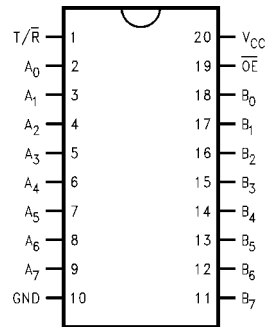

Pin Descriptions

Pin Names	Description
\overline{OE}	Output Enable Input
T/\bar{R}	Transmit/Receive Input
A_0 – A_7	Side A Inputs or 3-STATE Outputs (Bushold)
B_0 – B_7	Side B Inputs or 3-STATE Outputs (Bushold)

GTO™ is a trademark of Fairchild Semiconductor Corporation.

Truth Table

Inputs		Outputs
\overline{OE}	T/\overline{R}	
L	L	Bus B ₀ – B ₇ Data to Bus A ₀ – A ₇
L	H	Bus A ₀ – A ₇ Data to Bus B ₀ – B ₇
H	X	HIGH Z State on A ₀ – A ₇ , B ₀ – B ₇

H = HIGH Voltage Level
 L = LOW Voltage Level
 X = Immaterial
 Z = High Impedance

Logic Diagram

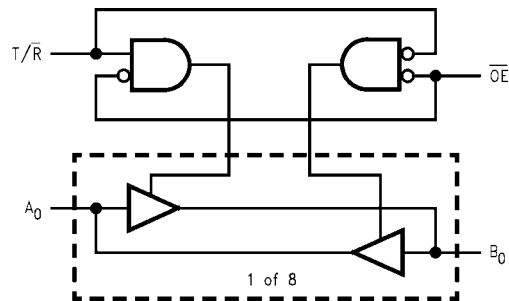

Absolute Maximum Ratings (Note 1)				
Symbol	Parameter	Value	Conditions	Units
V_{CC}	Supply Voltage	-0.5 to +7.0		V
V_I	T/R, \overline{OE} , I/O Ports	-0.5 to +7.0		V
V_O	DC Output Voltage	-0.5 to $V_{CC} + 0.5$	Output in HIGH or LOW State (Note 2)	V
I_{IK}	DC Input Diode Current	-50	$V_I < GND$	mA
I_{OK}	DC Output Diode Current	-50 +50	$V_O < GND$ $V_O > V_{CC}$	mA
I_O	DC Output Source/Sink Current	± 50		mA
I_{CC}	DC Supply Current per Supply Pin	± 100		mA
I_{GND}	DC Ground Current per Ground Pin	± 100		mA
T_{STG}	Storage Temperature	-65 to +150		$^{\circ}C$

Recommended Operating Conditions (Note 3)				
Symbol	Parameter	Min	Max	Units
V_{CC}	Supply Voltage			
	Operating	2.0	3.6	V
	Data Retention	1.5	3.6	V
V_I	Input Voltage	0	V_{CC}	V
V_O	Output Voltage			
	HIGH or LOW State	0	V_{CC}	V
	3-STATE	0	5.5	V
I_{OH}/I_{OL}	Output Current in I_{OH}/I_{OL} - A Outputs			
	$V_{CC} = 3.0V - 3.6V$		± 24	mA
	$V_{CC} = 2.7V - 3.0V$		± 12	mA
	$V_{CC} = 2.3V - 2.7V$		± 8	mA
	Output Current in I_{OH}/I_{OL} - B Outputs			
	$V_{CC} = 3.0V - 3.6V$		± 12	mA
	$V_{CC} = 2.7V - 3.0V$		± 8	mA
	$V_{CC} = 2.3V - 2.7V$		± 4	mA
T_A	Free-Air Operating Temperature	-40	85	$^{\circ}C$
$\Delta t/\Delta V$	Input Edge Rate, $V_{IN} = 0.8V - 2.0V$, $V_{CC} = 3.0V$	0	10	ns/V

Note 1: The Absolute Maximum Ratings are those values beyond which the safety of the device cannot be guaranteed. The device should not be operated at these limits. The parametric values defined in the Electrical Characteristics tables are not guaranteed at the Absolute Maximum Ratings. The "Recommended Operating Conditions" table will define the conditions for actual device operation.

Note 2: I_O Absolute Maximum Rating must be observed.

Note 3: Floating or unused control inputs must be HIGH or LOW.

DC Electrical Characteristics

Symbol	Parameter	Conditions	V_{CC} (V)	$T_A = -40^{\circ}C$ to $+85^{\circ}C$		Units
				Min	Max	
V_{IH}	HIGH Level Input Voltage		2.3 - 2.7	1.7		V
			2.7 - 3.6	2.0		V
V_{IL}	LOW Level Input Voltage		2.3 - 2.7		0.7	V
			2.7 - 3.6		0.8	V
V_{OH}	HIGH Level Output Voltage A Outputs	$I_{OH} = -100 \mu A$	2.3 - 3.6	$V_{CC} - 0.2$		V
		$I_{OH} = -8 \text{ mA}$	2.3	1.8		V
		$I_{OH} = -12 \text{ mA}$	2.7	2.2		V
		$I_{OH} = -16 \text{ mA}$	3.0	2.4		V
		$I_{OH} = -24 \text{ mA}$	3.0	2.2		V
V_{OH}	HIGH Level Output Voltage B Outputs	$I_{OH} = -100 \mu A$	2.3 - 3.6	$V_{CC} - 0.2$		V
		$I_{OH} = -4 \text{ mA}$	2.3	1.8		V
		$I_{OH} = -4 \text{ mA}$	2.7	2.2		V
		$I_{OH} = -6 \text{ mA}$	3.0	2.4		V
		$I_{OH} = -8 \text{ mA}$	2.7	2.0		V
		$I_{OH} = -12 \text{ mA}$	3.0	2.0		V

DC Electrical Characteristics (Continued)								
Symbol	Parameter	Conditions	V _{CC} (V)	T _A = -40°C to +85°C		Units		
				Min	Max			
V _{OL}	LOW Level Output Voltage A Outputs	I _{OL} = 100 μA	2.3 – 3.6		0.2	V		
		I _{OL} = 8 mA	2.3		0.6			
		I _{OL} = 12 mA	2.7		0.4			
		I _{OL} = 16 mA	3.0		0.4			
		I _{OL} = 24 mA	3.0		0.55			
V _{OL}	LOW Level Output Voltage B Outputs	I _{OL} = 100 μA	2.3 – 3.6		0.2	V		
		I _{OL} = 4 mA	2.3		0.6			
		I _{OL} = 4 mA	2.7		0.4			
		I _{OL} = 6 mA	3.0		0.55			
		I _{OL} = 8 mA	2.7		0.6			
		I _{OL} = 12 mA	3.0		0.8			
I _I	Input Leakage Current	V _I = V _{CC} or GND	2.3 – 3.6		±5.0	μA		
I _{I(HOLD)}	Bushold Input Minimum Drive Hold Current	V _{IN} = 0.7V	2.3	45		μA		
		V _{IN} = 1.7V		-45				
		V _{IN} = 0.8V	3.0	75				
		V _{IN} = 2.0V		-75				
I _{I(OD)}	Bushold Input Over-Drive Current to Change State	(Note 5)	2.7	300		μA		
		(Note 6)		-300				
		(Note 5)	3.6	450				
		(Note 6)		-450				
I _{OZ}	3-STATE I/O Leakage	V _O = V _{CC} or GND V _I = V _{IH} or V _{IL}	2.3 – 3.6		±5.0	μA		
I _{CC}	Quiescent Supply Current	V _I = V _{CC} or GND	2.3 – 3.6		10	μA		
		3.6V ≤ V _I , V _O ≤ 5.5V (Note 4)	2.3 – 3.6		±10			
ΔI _{CC}	Increase in I _{CC} per Input	V _{IH} = V _{CC} - 0.6V	2.3 – 3.6		500	μA		
<p>Note 4: Outputs disabled or 3-STATE only.</p> <p>Note 5: An external driver must source at least the specified current to switch from LOW-to-HIGH.</p> <p>Note 6: An external driver must sink at least the specified current to switch from HIGH-to-LOW.</p>								
AC Electrical Characteristics								
Symbol	Parameter	T _A = -40°C to +85°C, R _L = 500Ω						Units
		V _{CC} = 3.3V ± 0.3V		V _{CC} = 2.7V		V _{CC} = 2.5V ± 0.2V		
		C _L = 50 pF		C _L = 50 pF		C _L = 30 pF		
		Min	Max	Min	Max	Min	Max	
t _{PHL}	Propagation Delay A to B	1.5	8.0	1.5	9.0	1.5	9.6	ns
t _{PLH}	Propagation Delay B to A	1.5	7.0	1.5	8.0	1.5	8.4	ns
t _{PZL}	Output Enable Time A to B	1.5	9.5	1.5	10.5	1.5	11.0	ns
t _{PZH}	Output Enable Time B to A	1.5	8.5	1.5	9.5	1.5	10.5	ns
t _{PLZ}	Output Disable Time A to B	1.5	7.5	1.5	8.5	1.5	9.0	ns
t _{PHZ}	Output Disable Time B to A	1.5	7.5	1.5	8.5	1.5	9.0	ns
t _{OSSLH}	Output to Output Skew (Note 7)		1.0					ns
t _{OSLH}								
<p>Note 7: Skew is defined as the absolute value of the difference between the actual propagation delay for any two separate outputs of the same device. The specification applies to any outputs switching in the same direction, either HIGH-to-LOW (t_{OSSLH}) or LOW-to-HIGH (t_{OSLH}).</p>								

Dynamic Switching Characteristics					
Symbol	Parameter	Conditions	V _{CC} (V)	T _A = 25°C	Units
				Typical	
V _{OLP}	Quiet Output Dynamic Peak V _{OL} B to A	C _L = 30 pF, V _{IH} = 2.5V, V _{IL} = 0V	2.5	0.6	V
		C _L = 50 pF, V _{IH} = 3.3V, V _{IL} = 0V	3.3	0.8	
	Quiet Output Dynamic Peak V _{OL} A to B	C _L = 30 pF, V _{IH} = 2.5V, V _{IL} = 0V	2.5	0.4	V
		C _L = 50 pF, V _{IH} = 3.3V, V _{IL} = 0V	3.3	0.5	
V _{OLV}	Quiet Output Dynamic Valley V _{OL} B to A	C _L = 30 pF, V _{IH} = 2.5V, V _{IL} = 0V	2.5	-0.6	V
		C _L = 50 pF, V _{IH} = 3.3V, V _{IL} = 0V	3.3	-0.8	
	Quiet Output Dynamic Valley V _{OL} A to B	C _L = 30 pF, V _{IH} = 2.5V, V _{IL} = 0V	2.5	-0.4	V
		C _L = 50 pF, V _{IH} = 3.3V, V _{IL} = 0V	3.3	-0.5	
Capacitance					
Symbol	Parameter	Conditions	Typical	Units	
C _{IN}	Input Capacitance	V _{CC} = Open, V _I = 0V or V _{CC}	7	pF	
C _{I/O}	Input/Output Capacitance	V _{CC} = 3.3V, V _I = 0V or V _{CC}	8	pF	
C _{PD}	Power Dissipation Capacitance	V _{CC} = 3.3V, V _I = 0V or V _{CC} , f = 10 MHz	25	pF	

AC LOADING and WAVEFORMS Generic for LCX Family

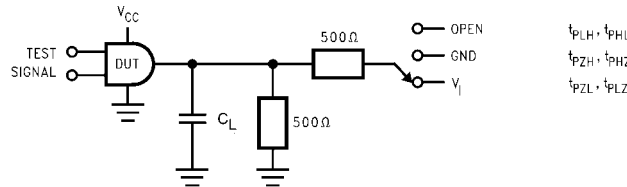
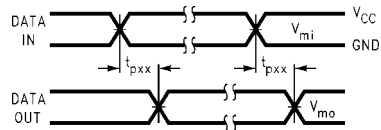
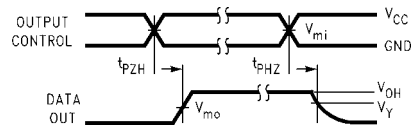

FIGURE 1. AC Test Circuit (C_L includes probe and jig capacitance)

Test	Switch
t_{PLH} , t_{PHL}	Open
t_{PZL} , t_{PLZ}	6V at $V_{CC} = 3.3 \pm 0.3V$; and 2.7V $V_{CC} \times 2$ at $V_{CC} = 2.5 \pm 0.2V$
t_{PZH} , t_{PHZ}	GND



Waveform for Inverting and Non-Inverting Functions



3-STATE Output High Enable and Disable Times for Logic

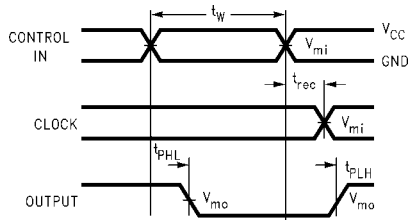

Propagation Delay, Pulse Width and t_{rec} Waveforms

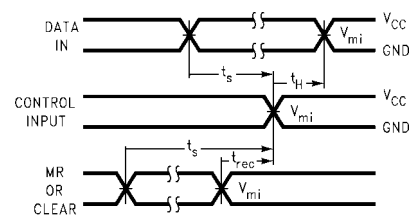

Setup Time, Hold Time and Recovery Time for Logic



3-STATE Output Low Enable and Disable Times for Logic

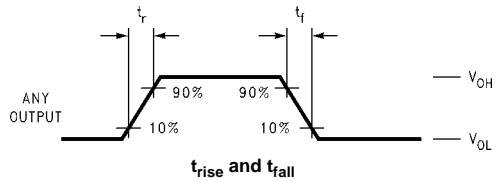
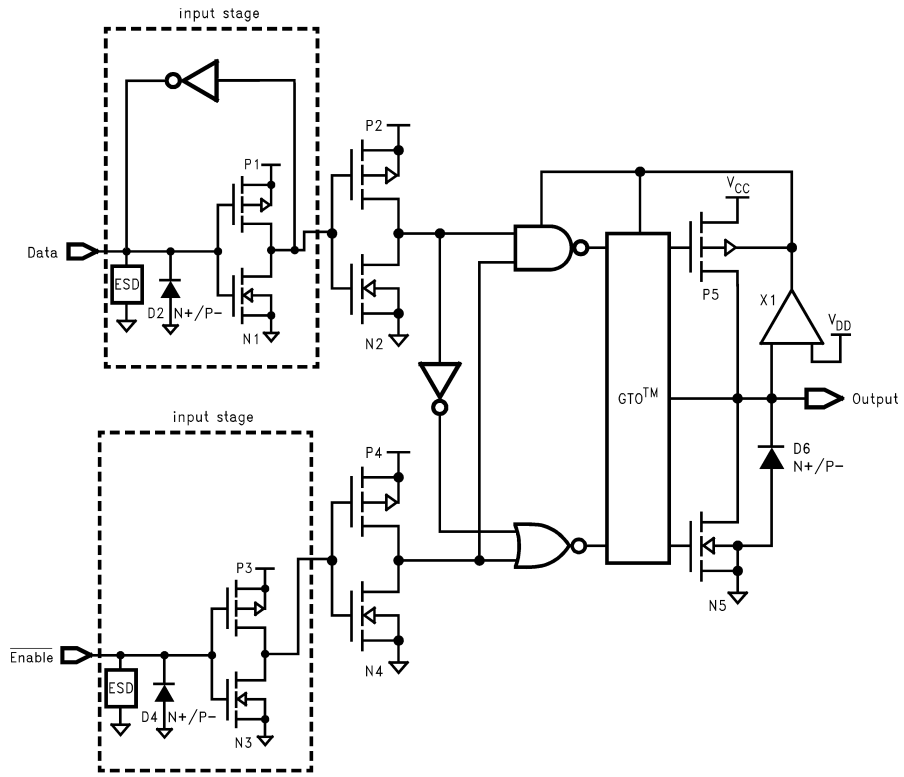

FIGURE 2. Waveforms (Input Characteristics; $f = 1MHz$, $t_r = t_f = 3ns$)

Symbol	V_{CC}		
	$3.3V \pm 0.3V$	2.7V	$2.5V \pm 0.2V$
V_{mi}	1.5V	1.5V	$V_{CC}/2$
V_{mo}	1.5V	1.5V	$V_{CC}/2$
V_x	$V_{OL} + 0.3V$	$V_{OL} + 0.3V$	$V_{OL} + 0.15V$
V_y	$V_{OH} - 0.3V$	$V_{OH} - 0.3V$	$V_{OH} - 0.15V$

Schematic Diagram Generic for LCXH Family (with Bushold)



74LCXH2245

Physical Dimensions inches (millimeters) unless otherwise noted



**20-Lead Small Outline Integrated Circuit (SOIC), JEDEC MS-013, 0.300" Wide
Package Number M20B**

Physical Dimensions inches (millimeters) unless otherwise noted (Continued)



LAND PATTERN RECOMMENDATION

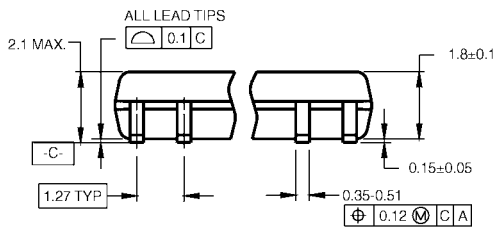

DIMENSIONS ARE IN MILLIMETERS

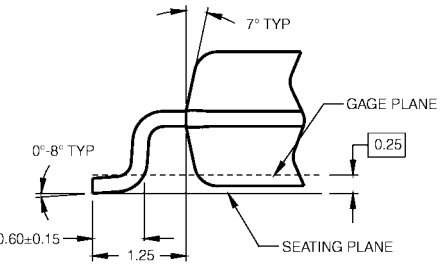
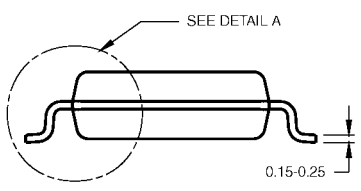

DETAIL A

- NOTES:
 A. CONFORMS TO EIAJ EDR-7320 REGISTRATION, ESTABLISHED IN DECEMBER, 1998.
 B. DIMENSIONS ARE IN MILLIMETERS.
 C. DIMENSIONS ARE EXCLUSIVE OF BURRS, MOLD FLASH, AND TIE BAR EXTRUSIONS.

M20DRevB1

Pb-Free 20-Lead Small Outline Package (SOP), EIAJ TYPE II, 5.3mm Wide Package Number M20D

74LCXH2245

Physical Dimensions inches (millimeters) unless otherwise noted (Continued)

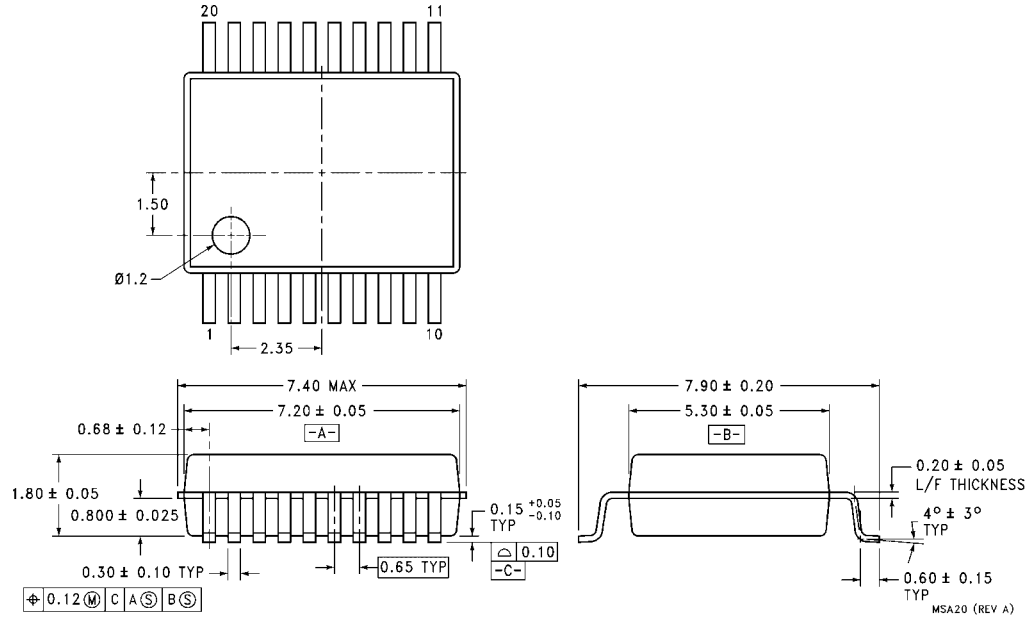

**20-Lead Shrink Small Outline Package (SSOP), JEDEC MO-150, 5.3mm Wide
Package Number MSA20**

Physical Dimensions inches (millimeters) unless otherwise noted (Continued)

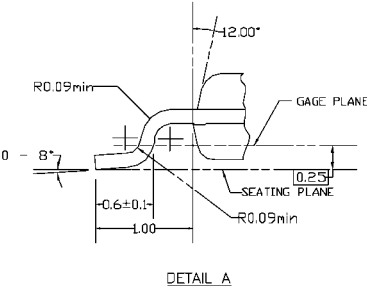
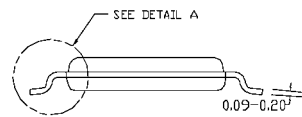
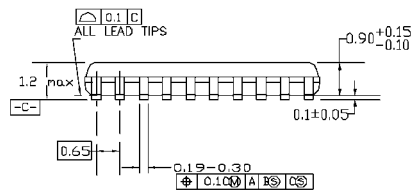
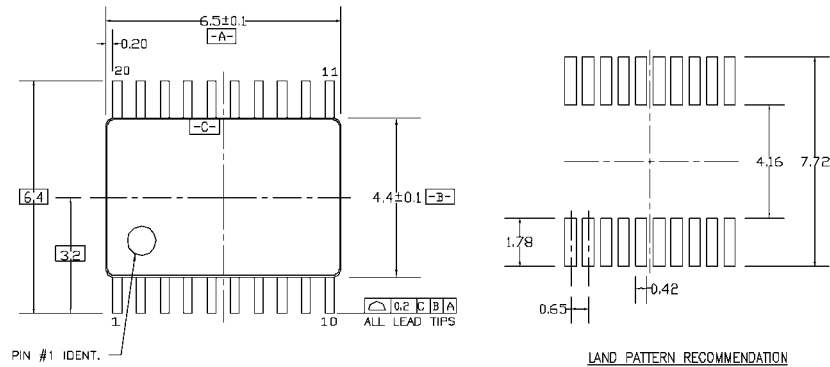

DIMENSIONS ARE IN MILLIMETERS

NOTES:

- A. CONFORMS TO JEDEC REGISTRATION MO-153, VARIATION AC, REF NOTE 6, DATE 7/93.
- B. DIMENSIONS ARE IN MILLIMETERS.
- C. DIMENSIONS ARE EXCLUSIVE OF BURRS, MOLDS FLASH, AND TIE BAR EXTRUSIONS.
- D. DIMENSIONS AND TOLERANCES PER ANSI Y14.5M, 1982.

MTC20REVD1

20-Lead Thin Shrink Small Outline Package (TSSOP), JEDEC MO-153, 4.4mm Wide Package Number MTC20

Fairchild does not assume any responsibility for use of any circuitry described, no circuit patent licenses are implied and Fairchild reserves the right at any time without notice to change said circuitry and specifications.

LIFE SUPPORT POLICY

FAIRCHILD'S PRODUCTS ARE NOT AUTHORIZED FOR USE AS CRITICAL COMPONENTS IN LIFE SUPPORT DEVICES OR SYSTEMS WITHOUT THE EXPRESS WRITTEN APPROVAL OF THE PRESIDENT OF FAIRCHILD SEMICONDUCTOR CORPORATION. As used herein:

1. Life support devices or systems are devices or systems which, (a) are intended for surgical implant into the body, or (b) support or sustain life, and (c) whose failure to perform when properly used in accordance with instructions for use provided in the labeling, can be reasonably expected to result in a significant injury to the user.
2. A critical component in any component of a life support device or system whose failure to perform can be reasonably expected to cause the failure of the life support device or system, or to affect its safety or effectiveness.

www.fairchildsemi.com