

High-Voltage, Linear High-Brightness LED Driver with Open-LED Fault Detect

General Description

The MAX16839 programmable current regulator operates from a 5V to 40V input voltage range and features an open-drain, constant-current-sink output capable of sinking up to 100mA. The MAX16839 is well suited for automotive applications and other applications that require a general-purpose linear LED driver. The device directly withstands automotive load-dump events of up to 45V.

An on-board pass element minimizes external component count while providing $\pm 5\%$ output current accuracy. The MAX16839 includes a dimming input that controls the duty cycle of the output current, allowing a wide LED dimming range. In addition, the dimming input functions as an on/off control of the output current. In multiple LED-string applications, the dimming input synchronizes the LED current-sink turn-on, ensuring simultaneous brightness in LED strings.

Additional features include thermal and open-LED protection and an open-LED fault-detection output. In multiple LED string applications where all FLTS pins are connected together, an open-LED detection in one LED string turns off all the strings simultaneously. Open-LED protection also features fault memory, to avoid LED flashing during subsequent power-up cycles.

The MAX16839 is available in thermally enhanced, 6-pin TDFN-EP and 8-pin SO-EP packages and is specified over the -40°C to $+125^{\circ}\text{C}$ automotive temperature range.

Applications

Automotive Exterior: Turn Signal Light, Brake Light, Tail and Marker Lights

Automotive Interior: Cluster and Warning Lights, Dome and Map Lights

Truck, Train, Airplane, and Emergency Car LED Lighting

General Lighting: Signage, LED Lamps

Pin Configurations appear at end of data sheet.

Features

- ◆ 5V to 40V Operating Range
- ◆ Integrated 2Ω Open-Drain Pass Transistor
- ◆ 15mA to 100mA Programmable LED Current
- ◆ PWM Dimming
- ◆ Open-LED Fault Detection
- ◆ Open-LED Fault Event Status Memory
- ◆ LED Open-Fault Detect Latches Off Multiple LED Strings
- ◆ Multichip Synchronized LED Current Sink
- ◆ $\pm 5\%$ LED Current Accuracy
- ◆ -40°C to $+125^{\circ}\text{C}$ Operating Temperature Range
- ◆ Thermal Protection
- ◆ Undervoltage Lockout
- ◆ 6-Pin TDFN-EP and 8-Pin SO-EP Packages

Ordering Information

| PART | TEMP RANGE | PIN-PACKAGE |
|----------------|---|-------------|
| MAX16839ATT+ | -40°C to $+125^{\circ}\text{C}$ | 6 TDFN-EP* |
| MAX16839ASA+ | -40°C to $+125^{\circ}\text{C}$ | 8 SO-EP* |
| MAX16839ATT/V+ | -40°C to $+125^{\circ}\text{C}$ | 6 TDFN-EP* |

+Denotes a lead(Pb)-free/RoHS-compliant package.

*EP = Exposed pad.

V denotes an automotive qualified part.

Typical Application Circuit

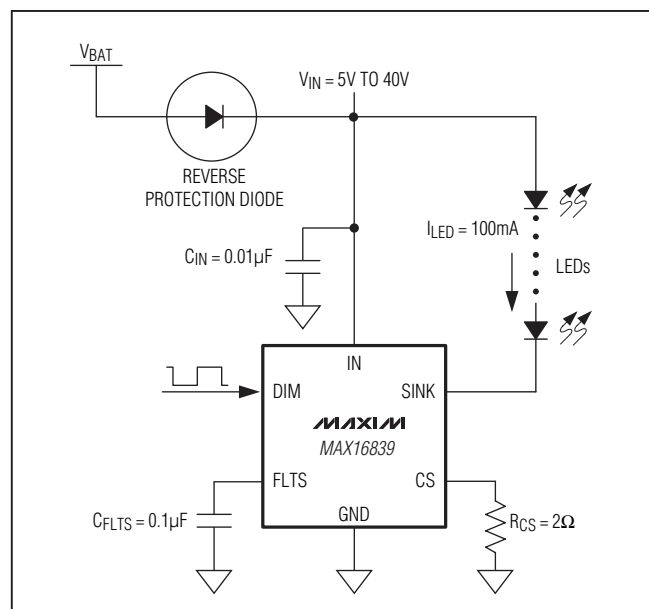

High-Voltage, Linear High-Brightness LED Driver with Open-LED Fault Detect

MAX16839

ABSOLUTE MAXIMUM RATINGS

(Voltages are specified with respect to GND.)

| | |
|---|----------------|
| IN, SINK..... | -0.3V to +45V |
| FLTS | -0.3V to +18V |
| DIM | -0.3V to +6V |
| CS..... | -0.3V to +0.5V |
| Continuous Current into SINK and CS..... | 120mA |
| Continuous Power Dissipation (T _A = +70°C) | |
| 6-Pin TDFN (derate 23.8mW/°C above +70°C) | 1904.8mW |
| 8-Pin SO (derate 18.9mW/°C above +70°C)..... | 1509.4mW |

| | |
|---|-----------------|
| Operating Temperature Range | -40°C to +125°C |
| Junction Temperature | +150°C |
| Storage Temperature..... | -65°C to +150°C |
| Lead Temperature (soldering, 10s) | +300°C |
| Soldering Temperature (reflow) | +260°C |

Stresses beyond those listed under "Absolute Maximum Ratings" may cause permanent damage to the device. These are stress ratings only, and functional operation of the device at these or any other conditions beyond those indicated in the operational sections of the specifications is not implied. Exposure to absolute maximum rating conditions for extended periods may affect device reliability.

PACKAGE THERMAL CHARACTERISTICS (Note 1)

| TDFN | | SO | |
|---|--------|---|--------|
| Junction-to-Ambient Thermal Resistance (θ _{JA}) | 42°C/W | Junction-to-Ambient Thermal Resistance (θ _{JA}) | 53°C/W |
| Junction-to-Case Thermal Resistance (θ _{JC}) | 9°C/W | Junction-to-Case Thermal Resistance (θ _{JC}) | 5°C/W |

Note 1: Package thermal resistances were obtained using the method described in JEDEC specification JESD51-7, using a four-layer board. For detailed information on package thermal considerations, refer to www.maxim-ic.com/thermal-tutorial.

ELECTRICAL CHARACTERISTICS

(V_{IN} = 12V, V_{FLTS} = 0V, R_{CS} = 4.07Ω, V_{GND} = 0V, DIM = unconnected, C_{IN} = 0.1μF (Note 2), T_J = T_A = -40°C to +125°C, unless otherwise noted. Typical values are at T_A = +25°C.) (Note 3)

| PARAMETER | SYMBOL | CONDITIONS | MIN | TYP | MAX | UNITS |
|--|-------------------|---|-------|------|-------|-------|
| Supply Voltage Range | V _{IN} | | 5 | | 40 | V |
| Quiescent Current | I _{IN} | | | 0.25 | 0.6 | mA |
| Undervoltage Lockout | V _{UVLO} | V _{IN} rising | | 3.6 | | V |
| UVLO Hysteresis | | | | 0.3 | | V |
| CS REGULATOR | | | | | | |
| CS Voltage Accuracy | V _{CS} | T _A = +25°C | 195.5 | 203 | 210.5 | mV |
| | | -40°C ≤ T _A ≤ +125°C, 0.9V ≤ V _{SINK} ≤ 5.5V (Note 4) | 193 | | 213 | |
| CS Load Regulation | | 20mA ≤ I _{SINK} ≤ 100mA | | 40 | | μV/mA |
| Internal Switch On-Resistance | R _{DSON} | (Note 5) | | 2 | 4 | Ω |
| LED CURRENT TRANSIENT RESPONSE | | | | | | |
| LED Current Turn-On Delay | t _{DIN} | 30% of V _{IN} rising edge to 50% of I _{SINK} , V _{DIM} = 2.1V (Notes 6, 7) | | 4 | 9 | μs |
| LED Current Turn-On Delay Relative to DIM | t _{DDIN} | V _{DIM} rising edge to 50% of I _{SINK} | | 2.3 | 5.5 | μs |
| LED Current Turn-Off Delay Relative to DIM | | V _{DIM} falling edge to 50% of I _{SINK} | | 1.3 | 3.5 | μs |
| LED Current Rise Time | t _r | 10% of I _{SINK} to 90% of I _{SINK} | | 2.5 | 5.5 | μs |
| LED Current Fall Time | t _f | 90% of I _{SINK} to 10% of I _{SINK} | | 2.5 | 6 | μs |

High-Voltage, Linear High-Brightness LED Driver with Open-LED Fault Detect

MAX16839

ELECTRICAL CHARACTERISTICS (continued)

($V_{IN} = 12V$, $V_{FLTS} = 0V$, $R_{CS} = 4.07\Omega$, $V_{GND} = 0V$, DIM = unconnected, $C_{IN} = 0.1\mu F$ (Note 2), $T_J = T_A = -40^\circ C$ to $+125^\circ C$, unless otherwise noted. Typical values are at $T_A = +25^\circ C$.) (Note 3)

| PARAMETER | SYMBOL | CONDITIONS | MIN | TYP | MAX | UNITS |
|---|----------------|--|-------|------|------|------------|
| FAULT EVENT STATUS MEMORY | | | | | | |
| FLTS Activation Threshold | V_{INTH} | V_{IN} rising, $V_{CS} = 0V$ | 7 | 7.38 | 7.75 | V |
| FLTS Activation Hysteresis | | | | 20 | | mV |
| LED Open Threshold | V_{CSO} | | 25 | 30 | 35 | mV |
| LED Open Blanking | T_B | | 14 | 25 | 50 | μs |
| Fault Voltage | V_{FLTS} | $V_{IN} = 40V$, $V_{CS} = 0V$, $C_{FLTS} = 0.1\mu F$ | 12 | 15 | 18 | V |
| FLTS Charge Current | I_{CFLTS} | $V_{CS} \leq 25mV$ | 0.65 | 2.8 | 4.8 | mA |
| FLTS Discharge Current | | $V_{FLTS} = 0.5V$ | 2.25 | 5 | 7.25 | μA |
| FLTS Threshold To Turn Off LED Current Sink | V_{FLTH} | | 0.95 | 1.3 | 1.65 | V |
| DIM LOGIC | | | | | | |
| Input High Voltage | V_{IH} | | 2.1 | | | V |
| Input Low Voltage | V_{IL} | | | | 0.8 | V |
| DIM Voltage Logic Hysteresis | V_{DIM_HYS} | | | 0.15 | | V |
| DIM Pullup Current | | $V_{DIM} = 0V$ | 10 | 30 | 60 | μA |
| DIM Pulldown Current | | $V_{DIM} = 0.8V$, $V_{IN} = 2.4V$ | 0.385 | 1 | 1.5 | mA |
| DIM Pulse Width | | | 70 | | | μs |
| DIM Frequency | f_{DIM} | | | | 10 | kHz |
| LEAKAGE CURRENTS | | | | | | |
| SINK Leakage Current | | $V_{SINK} = 40V$, $V_{DIM} = 0V$ | | | 1 | μA |
| FLTS Leakage Current | | $V_{FLTS} = 8V$, $V_{IN} = 0V$ | | | 1 | μA |
| THERMAL SHUTDOWN | | | | | | |
| Thermal Shutdown Temperature | | Temperature rising | | 160 | | $^\circ C$ |
| Thermal Shutdown Hysteresis | | | | 15 | | $^\circ C$ |

Note 2: A 51Ω resistor is connected between SINK and a 6.5V supply to reduce power dissipation during the factory test.

Note 3: All devices are 100% production tested at $T_A = +25^\circ C$. Limits over temperature are guaranteed by design.

Note 4: Guaranteed by design and not production tested.

Note 5: Internal switch resistance is measured with $I_{SINK} = 0.95 \times I_{SINK0}$ (I_{SINK0} is I_{SINK} at $V_{SINK} = 0.9V$).

Note 6: Supply turn-on delay will be measured by rising supply in $6\mu s$ from GND to 12V, and measurement starts when $V_{IN} = 4V$ (typical UVLO).

Note 7: DIM is kept high to avoid delay due to high capacitance from test setup. In applications, a $30\mu A$ pullup current charges parasitic capacitance at DIM with negligible delay. Ensure that unnecessary capacitance is not added at DIM during the PCB layout.

High-Voltage, Linear High-Brightness LED Driver with Open-LED Fault Detect

Typical Operating Characteristics

($V_{IN} = 12V$, $R_{CS} = 4.07\Omega$ from CS to GND, $C_{FLTS} = 0.1\mu F$, $C_{IN} = 0.1\mu F$, DIM input unconnected, $T_A = +25^\circ C$, unless otherwise noted. Typical values are at $T_A = +25^\circ C$.)

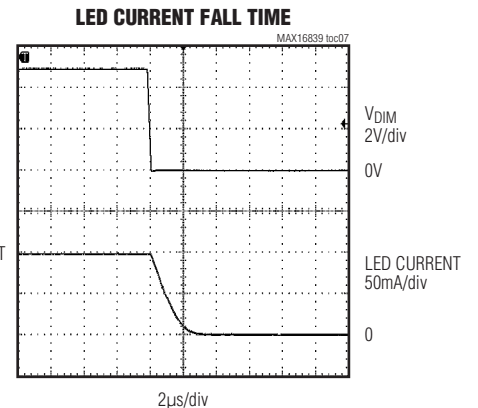
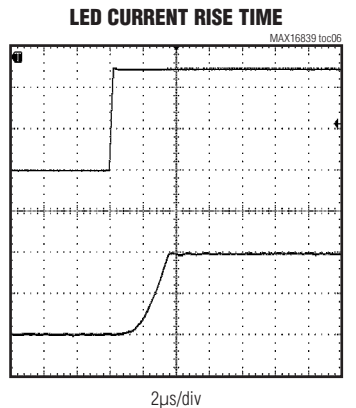
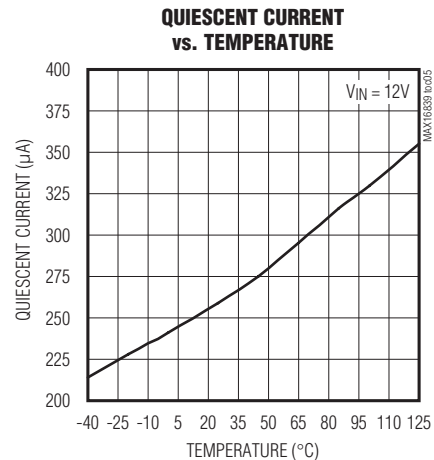
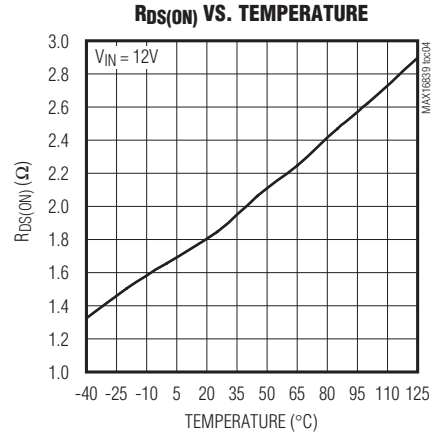
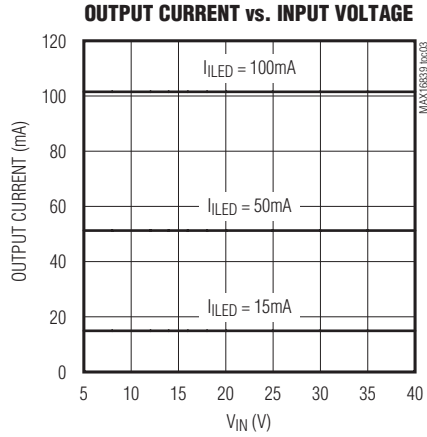
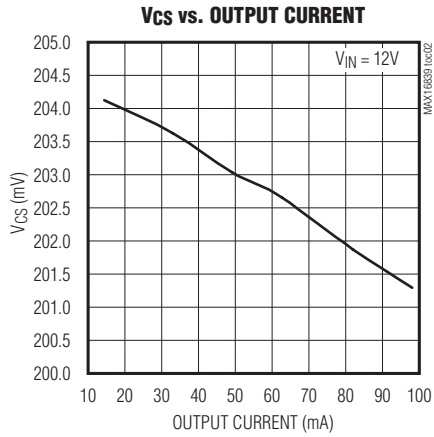
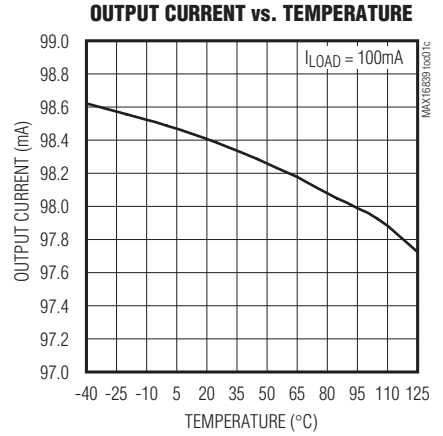
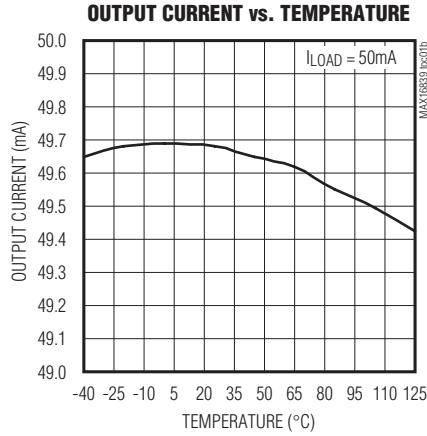
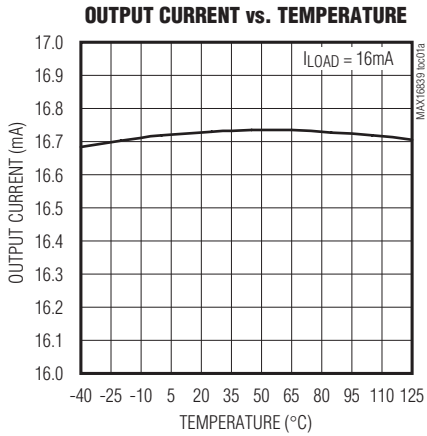

High-Voltage, Linear High-Brightness LED Driver with Open-LED Fault Detect

MAX16839

Typical Operating Characteristics (continued)

($V_{IN} = 12V$, $R_{CS} = 4.07\Omega$ from CS to GND, $C_{FLTS} = 0.1\mu F$, $C_{IN} = 0.1\mu F$, DIM input unconnected, $T_A = +25^\circ C$, unless otherwise noted. Typical values are at $T_A = +25^\circ C$.)

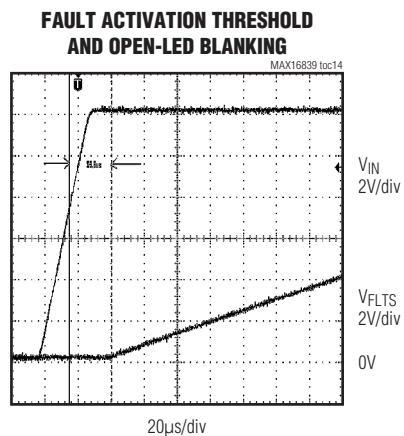
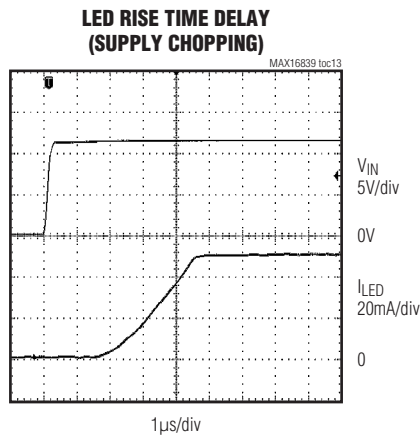
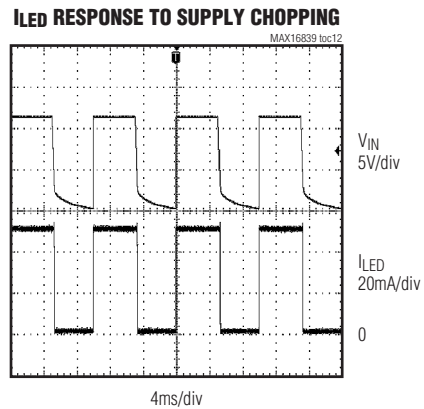
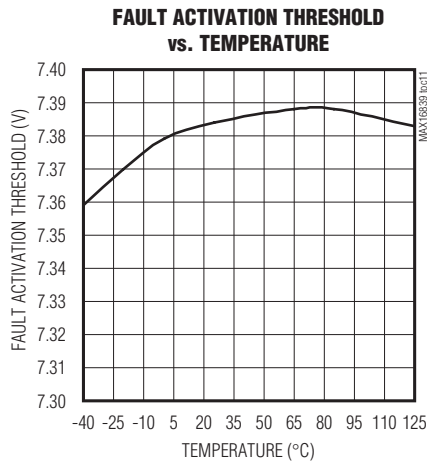
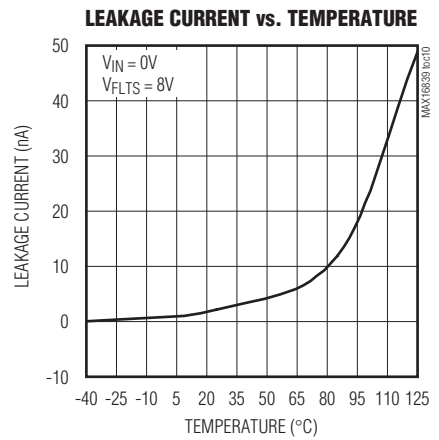
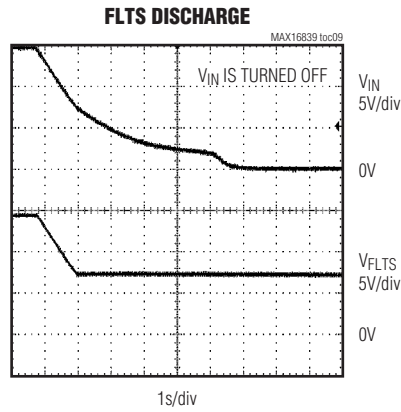
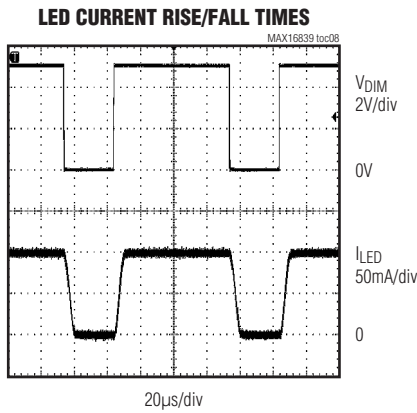

High-Voltage, Linear High-Brightness LED Driver with Open-LED Fault Detect

Typical Operating Characteristics (continued)

($V_{IN} = 12V$, $R_{CS} = 4.07\Omega$ from CS to GND, $C_{FLTS} = 0.1\mu F$, $C_{IN} = 0.1\mu F$, DIM input unconnected, $T_A = +25^\circ C$, unless otherwise noted. Typical values are at $T_A = +25^\circ C$.)

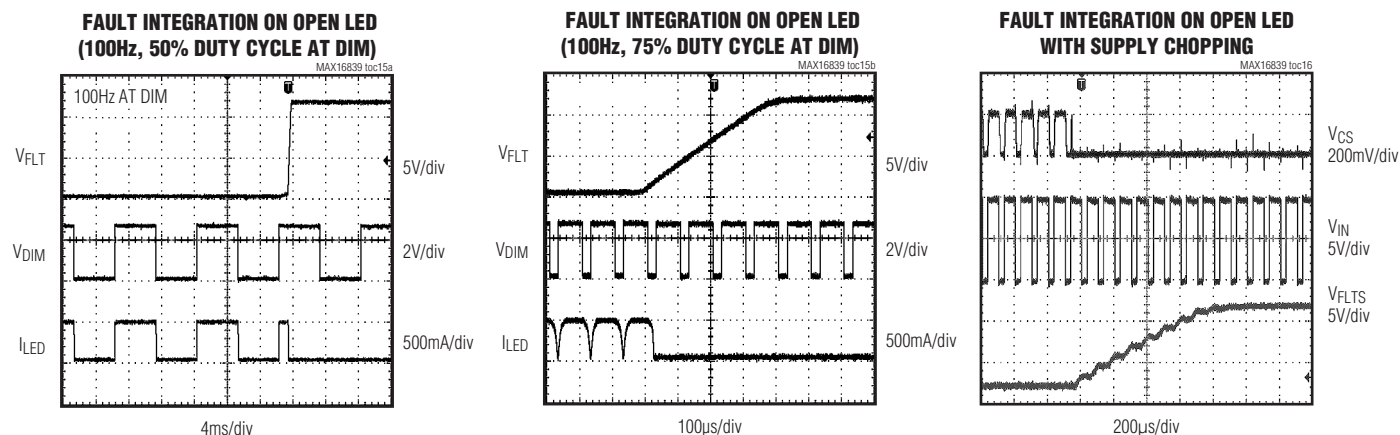

Pin Description

| PIN | | NAME | FUNCTION |
|------|------|------|---|
| TDFN | SO | | |
| 1 | 1 | IN | Positive Input Supply. Bypass with a 10nF (typ) capacitor to GND. |
| 2 | 2 | DIM | Dimming Input. Drive DIM high or leave unconnected to turn on the LED current-sink driver. Drive DIM low to turn off the LED current-sink driver. In multiple LED-string applications, connect all DIM inputs together to synchronize the LED current-sink turn-on. |
| 3 | 3 | FLTS | LED Fault Memory. Connect a 0.1 μ F to 10 μ F capacitor from FLTS to ground. In multiple LED-string applications, connect all FLTS pins together to have all strings latch off if one of them opens (see Figure 2). Connect FLTS to ground to disable fault protection. |
| 4 | 6 | GND | Ground |
| 5 | 7 | CS | Current-Sense Input. Connect a current-sense resistor between CS and GND to program the output current level. |
| 6 | 8 | SINK | LED Driver Current-Sink Output |
| — | 4, 5 | N.C. | No Connection. Not internally connected. |
| — | — | EP | Exposed Pad. Connect EP to a large-area contiguous copper ground plane for effective power dissipation. Do not use as the only IC ground connection. EP must be connected to GND. |

High-Voltage, Linear High-Brightness LED Driver with Open-LED Fault Detect

Detailed Description

The MAX16839 programmable current regulator operates from a 5V to 40V input voltage range and features an open-drain, constant-current-sink output capable of sinking up to 100mA. The MAX16839 directly withstands automotive load-dump events of up to 45V.

A single resistor-programmable output current and on-board pass element minimize the number of external components while providing $\pm 5\%$ output current accuracy. The MAX16839 includes a dimming input that controls the duty cycle of the output current, allowing a wide LED dimming range to be implemented. In addition, the dimming input functions as an on/off control of the output current. In multiple LED-string applications, the dimming input synchronizes the LED current-sink turn-on, ensuring simultaneous brightness in LED strings.

Additional features include thermal protection and an open-LED detection output that can turn off multiple LED strings simultaneously. See Figure 1.

Open-LED Detection and Fault Event Status Memory

The MAX16839 has an integrated open-LED detection that reduces external components required to implement this function. The following conditions enable the open-LED detection feature:

- FLTS not connected to ground
- $V_{IN} > V_{INTH}$ (7.38V) (typ)
- Thermal shutdown inactive
- $V_{DIM} = \text{High}$

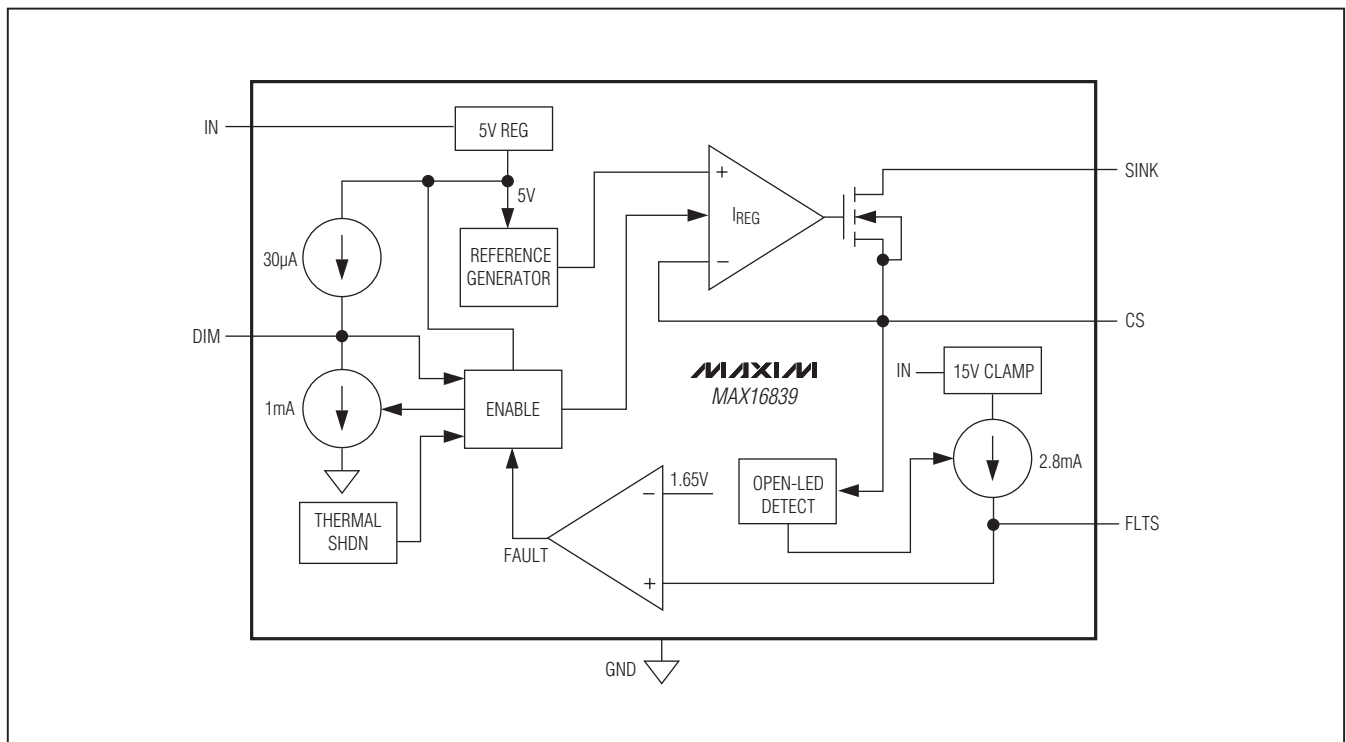

Figure 1. Internal Block Diagram

High-Voltage, Linear High-Brightness LED Driver with Open-LED Fault Detect

The MAX16839 detects an open-LED event when V_{CS} drops below 30mV for 25 μ s. When the fault condition is detected, a 2.8mA current source charges the capacitor between FLTS and ground, up to 15V or to V_{IN} if V_{IN} is less than 15V. If the voltage on FLTS is greater than 1.65V due to the charge retained in the FLTS capacitor, the LED driver is turned off. This provides an open-LED fault-protection feature that can be disabled by connecting FLTS to ground. In a multistring application (Figure 2), where all FLTS pins are connected together, a fault detected on one channel causes other channels to turn off as well. The retention capability on the FLTS is dependent on the leakage current and the value of the capacitor

used. If the retention capability is high, the fault condition could be retained or memorized for a long period after the supply is turned off.

Thermal Protection

The MAX16839 enters thermal-shutdown mode in the event of overheating. When the junction temperature exceeds $T_J = +160^{\circ}\text{C}$, the internal thermal-protection circuit turns off the series pass element. The MAX16839 recovers from thermal-shutdown mode when the junction temperature drops to $T_J = +145^{\circ}\text{C}$. FLTS does not assert during an overheating event.

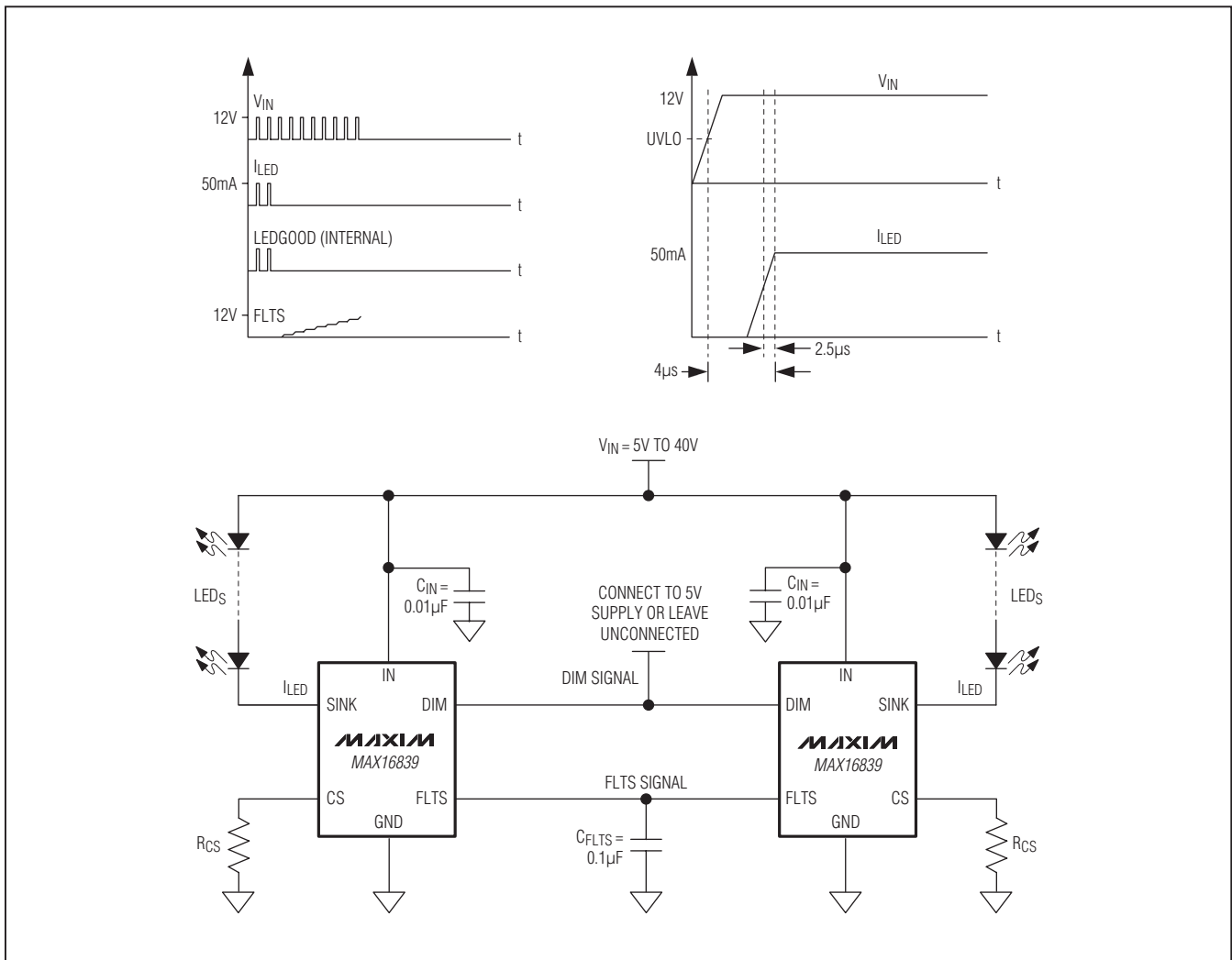

Figure 2. Multistring Application

High-Voltage, Linear High-Brightness LED Driver with Open-LED Fault Detect

MAX16839

Applications Information

FLTS Capacitor

If a fault condition is detected, a 2.8mA current source charges C_{FLTS} to memorize the fault condition and avoid flashing during the subsequent power-up cycles. The choice of the C_{FLTS} is based on the following conditions:

- Fault hold time
- Board leakage and FLTS leakage
- Input supply voltage, as this affects the maximum FLTS voltage
- The number of ICs connected together in case of a multistring application

Use the following equation to calculate the FLTS capacitor (C_{FLTS}):

$$C_{FLTS} = \frac{I_{FLTS} \times t_{FLTS} \times N}{(V_{FLTS} - V_{FLTH})}$$

where I_{FLTS} is the maximum leakage current through FLTS, t_{FLTS} is the desired fault retention period, V_{FLTS} is the typical voltage (minimum of 15V or the supply voltage) to which C_{FLTS} is charged during a fault event, V_{FLTH} is the minimum threshold to detect the fault memory as logic-high, and N is the number of devices in a multistring application.

Programming the LED Current

The MAX16839 uses a sense resistor to program the output current sink. To program the LED current, connect a sense resistor from the current-sense input (CS) to GND with short traces. The value of the sense resistor for a given desired current is calculated with the following equation:

$$R_{CS}(\Omega) = \frac{V_{CS}(V)}{I_{LED}(A)}$$

where V_{CS} is 203mV (typ) (see the *Electrical Characteristics* table).

Input Voltage

For proper operation, the minimum input voltage must always be:

$$V_{IN(MIN)} = V_{CS(MAX)} + V_{FT(MAX)} + \Delta V_{DO}$$

where $V_{CS(MAX)}$ is the maximum voltage drop across the sense resistor R_{CS} , $V_{FT(MAX)}$ is the total forward voltage of all series-connected LEDs, and ΔV_{DO} is the maximum

dropout voltage of the regulator. If the device is operated below $V_{IN(MIN)}$, the output current may not meet the full regulation specification (see the *Typical Operating Characteristics*).

For applications that require more than 3 LEDs per string and have slow supply rise time ($> 14\mu s$), FLTS should, in general, be connected to ground to avoid false triggering of the open-LED protection.

PWM Dimming

The MAX16839 includes a PWM dimming input (DIM) to control the LED brightness. An application of up to a 10kHz signal is recommended at DIM for proper operation. DIM also functions as an active-high enable input. Driving DIM low turns off the output. Driving DIM high or leaving DIM unconnected turns on the output.

For $V_{IN} >$ undervoltage-lockout threshold, the MAX16839 activates a 30 μA (typ) pullup current at DIM. When $V_{IN} <$ undervoltage-lockout threshold, the MAX16839 activates a 1mA pulldown current.

Supply Chopped Dimming

The MAX16839 can do efficient supply chopped dimming, as it is specially designed for very low startup delay. The LED current is turned on in 4 μs (typ) after the supply comes up. The LED current pulse-width modulates in phase with the supply voltage. Minimize the input filter capacitor after the chopper circuit for fast rise and fall times of the input supply.

Power Dissipation

The power dissipation (P_D) of the MAX16839 is determined from the following equation:

$$P_D = (V_{IN} \times I_{IN}) + [(V_{IN} - \Sigma V_{LED} - V_{CS}) \times (I_{LED} \times DUTY)]$$

where:

V_{IN} = Supply voltage

I_{IN} = Supply current

ΣV_{LED} = Total forward voltage for the LED string

I_{LED} = LED current

V_{CS} = 203mV drop across R_{CS}

DUTY = PWM duty cycle

The MAX16839 thermal specifications are given according to the JEDEC-51 guidelines. Good mechanical/thermal design practices must be applied to help maintain the device junction temperature below the absolute maximum ratings at all times.

High-Voltage, Linear High-Brightness LED Driver with Open-LED Fault Detect

Pin Configurations

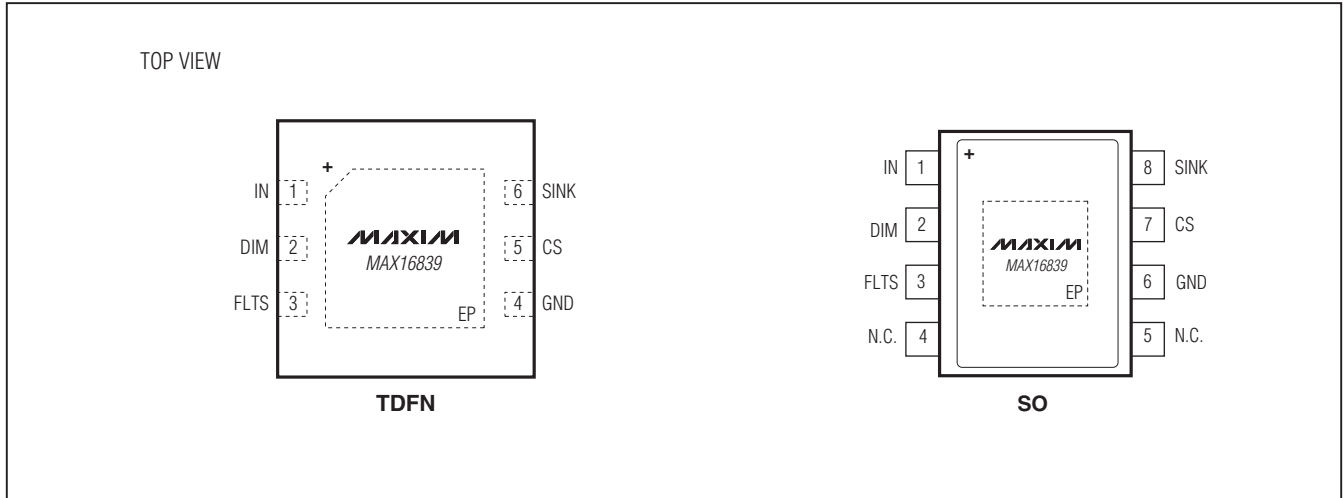

Chip Information

PROCESS: BiCMOS DMOS

Package Information

For the latest package outline information and land patterns (footprints), go to www.maxim-ic.com/packages. Note that a "+", "#", or "-" in the package code indicates RoHS status only. Package drawings may show a different suffix character, but the drawing pertains to the package regardless of RoHS status.

| PACKAGE TYPE | PACKAGE CODE | OUTLINE NO. | LAND PATTERN NO. |
|--------------|--------------|-------------------------|-------------------------|
| 6 TDFN-EP | T633+2 | 21-0137 | 90-0058 |
| 8 SO-EP | S8E+12 | 21-0111 | 90-0150 |

High-Voltage, Linear High-Brightness LED Driver with Open-LED Fault Detect

Revision History

| REVISION NUMBER | REVISION DATE | DESCRIPTION | PAGES CHANGED |
|-----------------|---------------|--|---------------|
| 0 | 7/9 | Initial release | — |
| 1 | 5/10 | Changed one feature of IC; replaced TOC 15 with two TOCs | 1, 2, 3, 5–11 |
| 2 | 12/10 | Corrected fault description | 7, 8, 10 |
| 3 | 1/11 | Corrected block diagram | 7 |
| 4 | 4/11 | Added automotive part | 1, 2 |

MAX16839

Maxim cannot assume responsibility for use of any circuitry other than circuitry entirely embodied in a Maxim product. No circuit patent licenses are implied. Maxim reserves the right to change the circuitry and specifications without notice at any time.

Maxim Integrated Products, 120 San Gabriel Drive, Sunnyvale, CA 94086 408-737-7600 _____ **11**