

## SINGLE 2-INPUT OR GATE

- HIGH SPEED:  $t_{PD} = 4.5\text{ns}$  (TYP.) at  $V_{CC} = 5\text{V}$
- LOW POWER DISSIPATION:  
 $I_{CC} = 1\mu\text{A}$ (MAX.) at  $T_A=25^\circ\text{C}$
- COMPATIBLE WITH TTL OUTPUTS:  
 $V_{IH} = 2\text{V}$  (MIN),  $V_{IL} = 0.8\text{V}$  (MAX)
- POWER DOWN PROTECTION ON INPUTS
- SYMMETRICAL OUTPUT IMPEDANCE:  
 $|I_{OH}| = I_{OL} = 8\text{mA}$  (MIN) at  $V_{CC} = 4.5\text{V}$
- BALANCED PROPAGATION DELAYS:  
 $t_{PLH} \cong t_{PHL}$
- OPERATING VOLTAGE RANGE:  
 $V_{CC}(\text{OPR}) = 4.5\text{V}$  to  $5.5\text{V}$
- IMPROVED LATCH-UP IMMUNITY

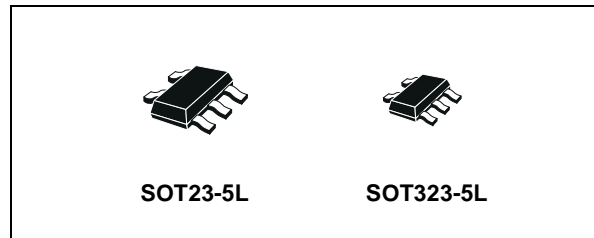

### ORDER CODES

PACKAGE	T & R
SOT23-5L	74V1T32STR
SOT323-5L	74V1T32CTR

### DESCRIPTION

The 74V1T32 is an advanced high-speed CMOS SINGLE 2-INPUT OR GATE fabricated with sub-micron silicon gate and double-layer metal wiring C<sup>2</sup>MOS technology. The internal circuit is composed of 2 stages including buffer output, which provide high noise immunity and stable output.

Power down protection is provided on all inputs and 0 to 7V can be accepted on inputs with no regard to the supply voltage. This device can be used to interface 5V to 3V.

### PIN CONNECTION AND IEC LOGIC SYMBOLS

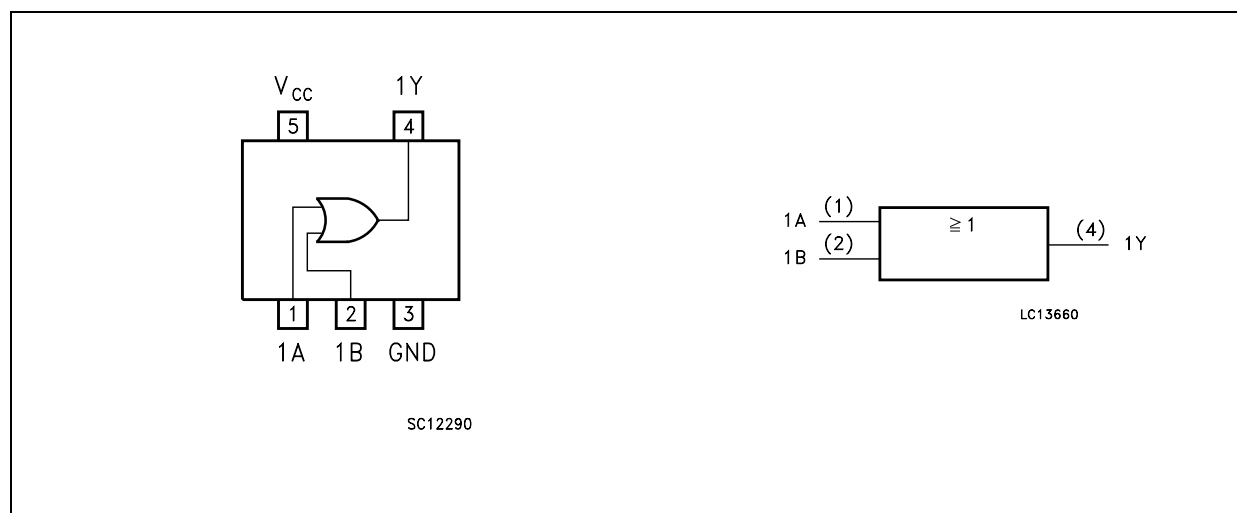



## DC SPECIFICATIONS

Symbol	Parameter	Test Condition		Value						Unit	
		V <sub>CC</sub> (V)		T <sub>A</sub> = 25°C			-40 to 85°C		-55 to 125°C		
				Min.	Typ.	Max.	Min.	Max.	Min.		Max.
V <sub>IH</sub>	High Level Input Voltage	4.5 to 5.5		2			2		2		V
V <sub>IL</sub>	Low Level Input Voltage	4.5 to 5.5				0.8		0.8		0.8	V
V <sub>OH</sub>	High Level Output Voltage	4.5	I <sub>O</sub> =-50 μA	4.4	4.5		4.4		4.4		V
		4.5	I <sub>O</sub> =-8 mA	3.94			3.8		3.7		
V <sub>OL</sub>	Low Level Output Voltage	4.5	I <sub>O</sub> =50 μA		0.0	0.1		0.1		0.1	V
		4.5	I <sub>O</sub> =8 mA			0.36		0.44		0.55	
I <sub>I</sub>	Input Leakage Current	0 to 5.5	V <sub>I</sub> = 5.5V or GND			± 0.1		± 1.0		± 1.0	μA
I <sub>CC</sub>	Quiescent Supply Current	5.5	V <sub>I</sub> = V <sub>CC</sub> or GND			1		10		20	μA
Δ I <sub>CC</sub>	Additional Worst Case Supply Current	5.5	One Input at 3.4V, other input at V <sub>CC</sub> or GND			1.35		1.5		1.5	mA

AC ELECTRICAL CHARACTERISTICS (Input t<sub>r</sub> = t<sub>f</sub> = 3ns)

Symbol	Parameter	Test Condition			Value						Unit	
		V <sub>CC</sub> (V)	C <sub>L</sub> (pF)		T <sub>A</sub> = 25°C			-40 to 85°C		-55 to 125°C		
					Min.	Typ.	Max.	Min.	Max.	Min.		Max.
t <sub>PLH</sub>	Propagation Delay Time	5.0 (*)	15			4.6	7.0	1.0	8.0	1.0	9.0	ns
t <sub>PHL</sub>		5.0 (*)	50			5.1	7.5	1.0	8.5	1.0	9.5	

(\*) Voltage range is 5.0V ± 0.5V

## CAPACITIVE CHARACTERISTICS

Symbol	Parameter	Test Condition		Value						Unit	
				T <sub>A</sub> = 25°C			-40 to 85°C		-55 to 125°C		
				Min.	Typ.	Max.	Min.	Max.	Min.		Max.
C <sub>IN</sub>	Input Capacitance				4	10		10		10	pF
C <sub>PD</sub>	Power Dissipation Capacitance (note 1)				14						pF

1) C<sub>PD</sub> is defined as the value of the IC's internal equivalent capacitance which is calculated from the operating current consumption without load. (Refer to Test Circuit). Average operating current can be obtained by the following equation. I<sub>CC(oper)</sub> = C<sub>PD</sub> × V<sub>CC</sub> × f<sub>IN</sub> + I<sub>CC</sub>

TEST CIRCUIT

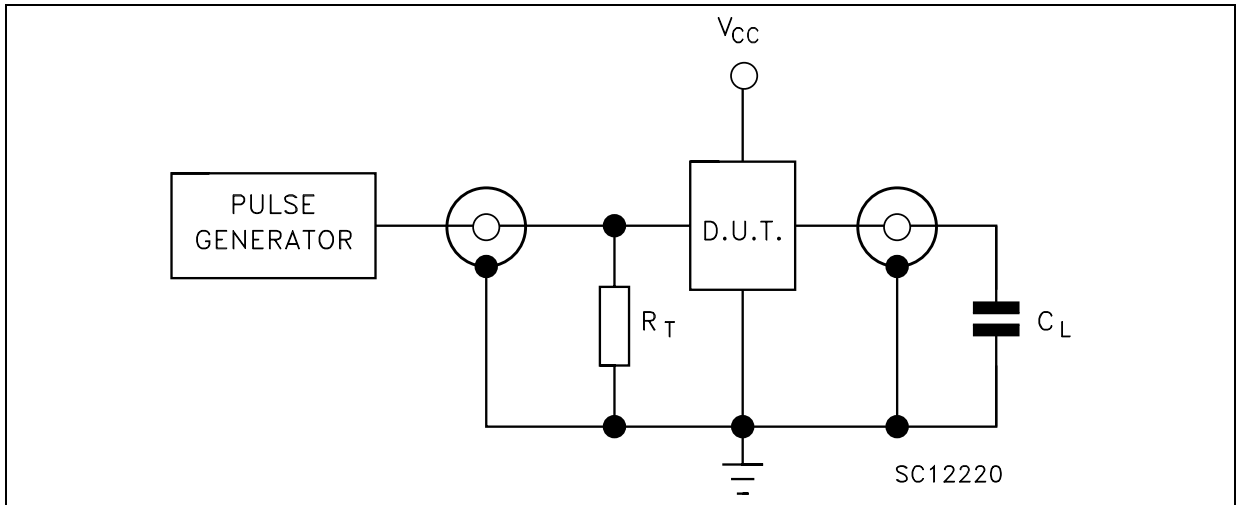

$C_L = 15/50\text{pF}$  or equivalent (includes jig and probe capacitance)  
 $R_T = Z_{OUT}$  of pulse generator (typically  $50\Omega$ )

WAVEFORM: PROPAGATION DELAY ( $f=1\text{MHz}$ ; 50% duty cycle)

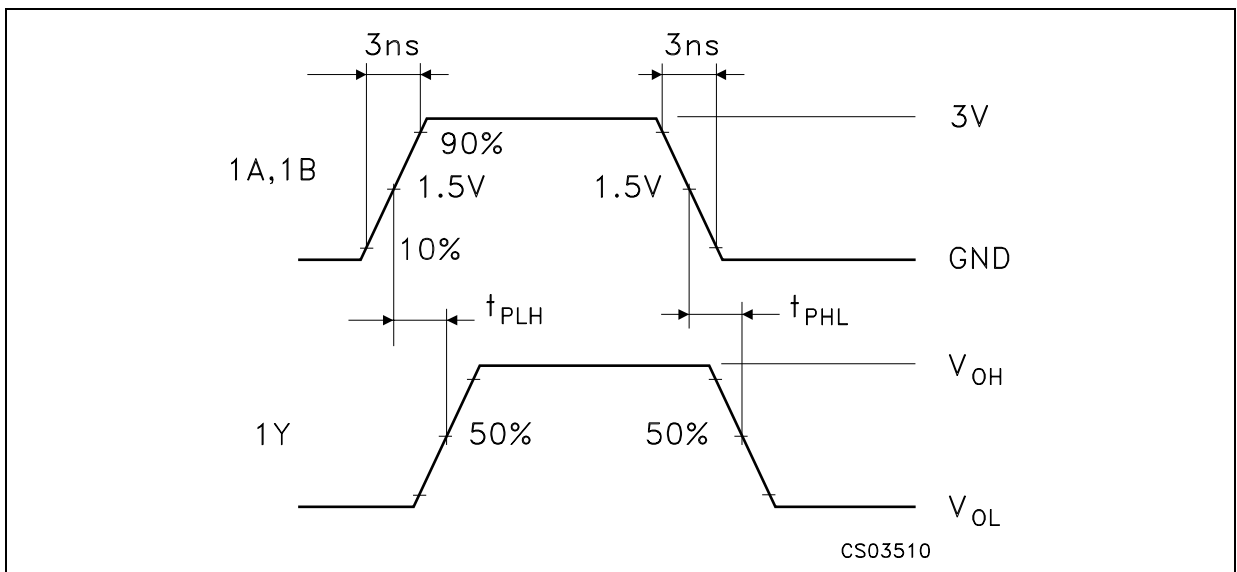

## SOT23-5L MECHANICAL DATA

DIM.	mm.			mils		
	MIN.	TYP.	MAX.	MIN.	TYP.	MAX.
A	0.90		1.45	35.4		57.1
A1	0.00		0.15	0.0		5.9
A2	0.90		1.30	35.4		51.2
b	0.35		0.50	13.7		19.7
C	0.09		0.20	3.5		7.8
D	2.80		3.00	110.2		118.1
E	2.60		3.00	102.3		118.1
E1	1.50		1.75	59.0		68.8
e		0.95			37.4	
e1		1.9			74.8	
L	0.35		0.55	13.7		21.6

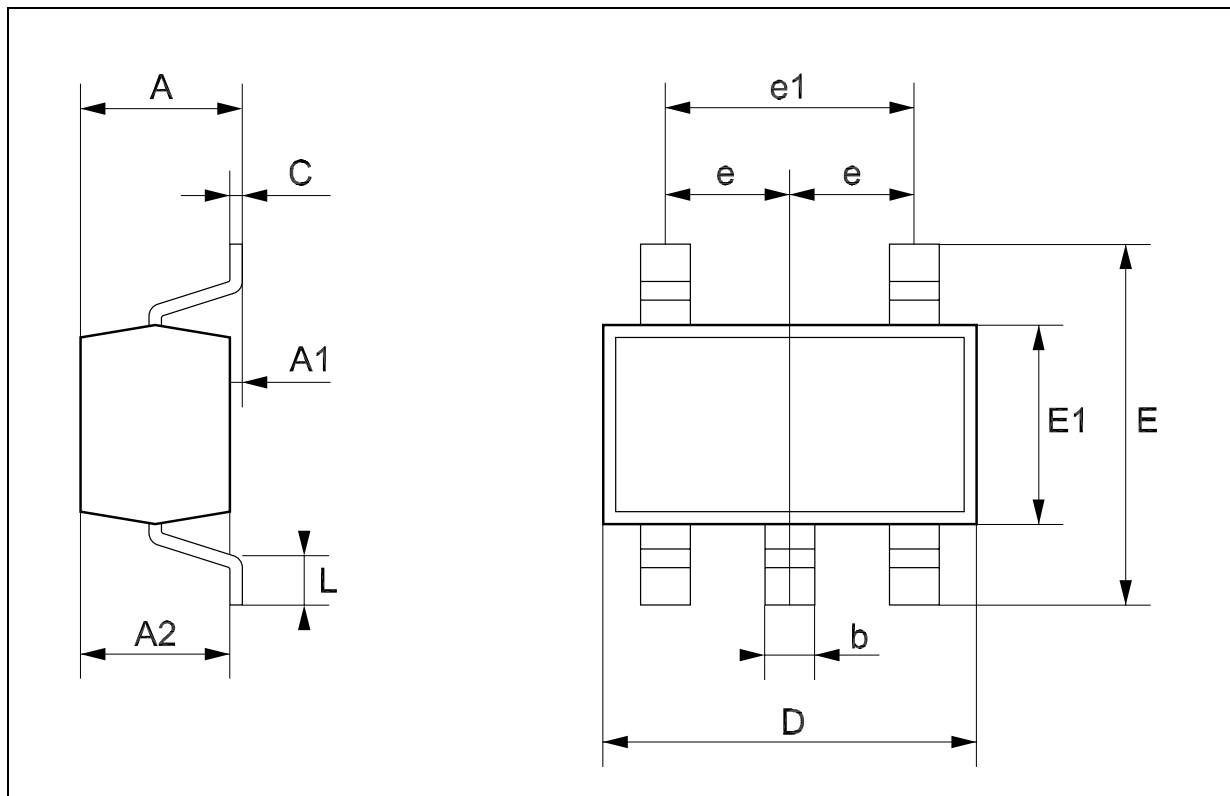

## SOT323-5L MECHANICAL DATA

DIM.	mm.			mils		
	MIN.	TYP	MAX.	MIN.	TYP.	MAX.
A	0.80		1.10	31.5		43.3
A1	0.00		0.10	0.0		3.9
A2	0.80		1.00	31.5		39.4
b	0.15		0.30	5.9		11.8
C	0.10		0.18	3.9		7.1
D	1.80		2.20	70.9		86.6
E	1.80		2.40	70.9		94.5
E1	1.15		1.35	45.3		53.1
e		0.65			25.6	
e1		1.3			51.2	
L	0.10		0.30	3.9		11.8

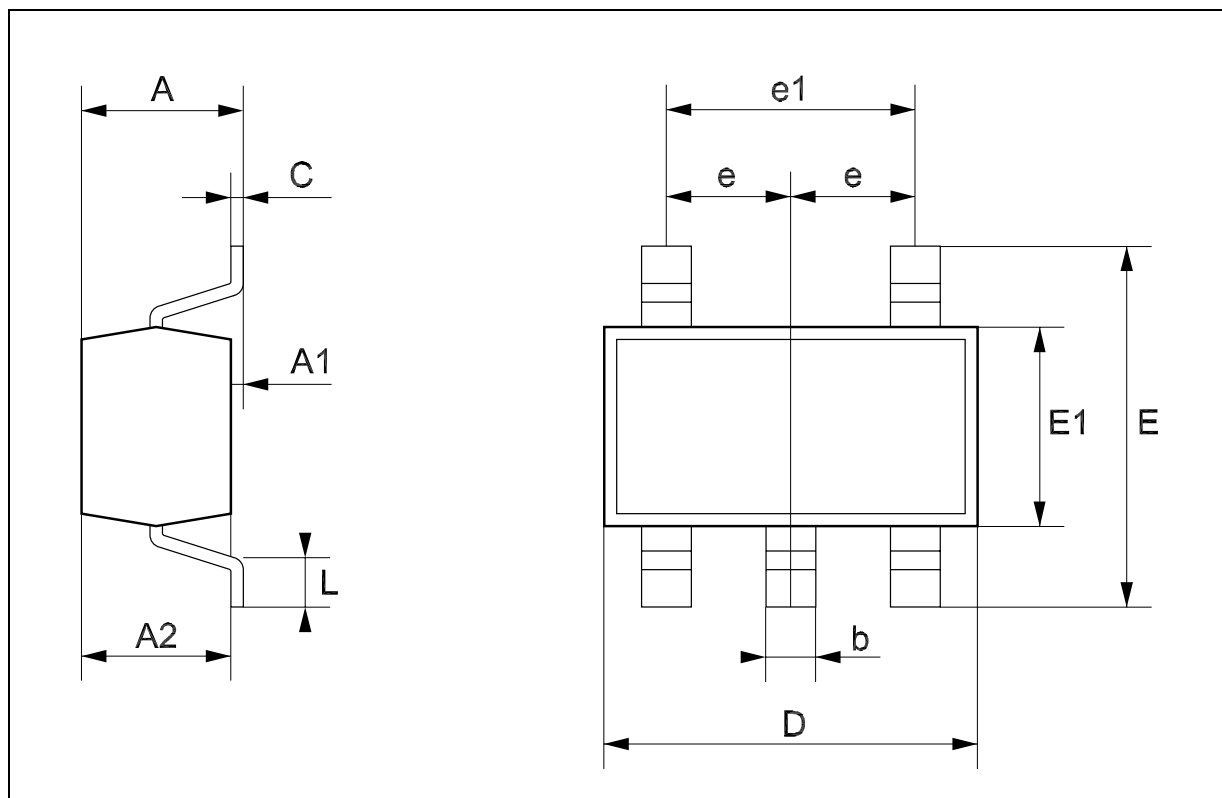

### Tape & Reel SOT23-xL MECHANICAL DATA

DIM.	mm.			inch		
	MIN.	TYP	MAX.	MIN.	TYP.	MAX.
A			180			7.086
C	12.8	13.0	13.2	0.504	0.512	0.519
D	20.2			0.795		
N	60			2.362		
T			14.4			0.567
Ao	3.13	3.23	3.33	0.123	0.127	0.131
Bo	3.07	3.17	3.27	0.120	0.124	0.128
Ko	1.27	1.37	1.47	0.050	0.054	0.058
Po	3.9	4.0	4.1	0.153	0.157	0.161
P	3.9	4.0	4.1	0.153	0.157	0.161

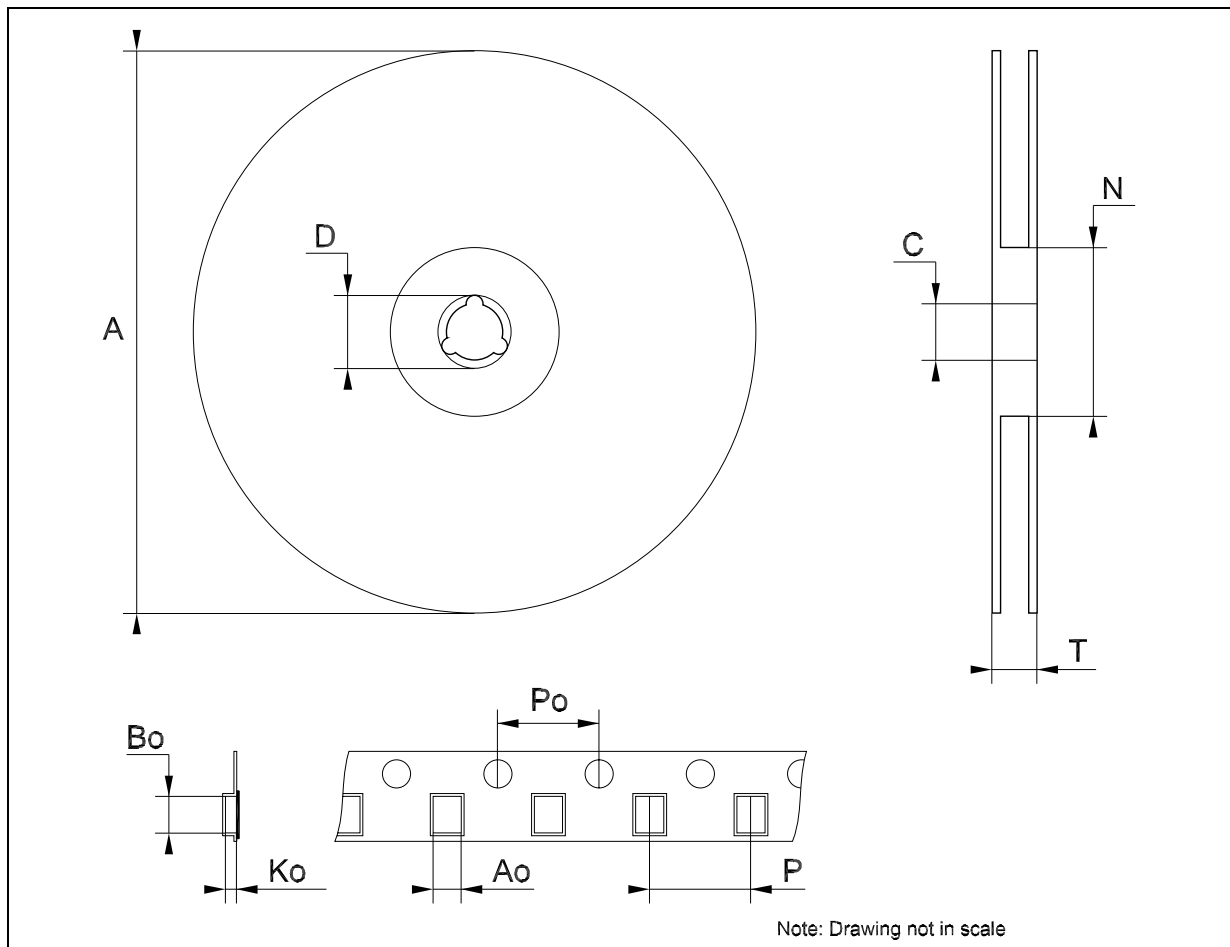

## Tape &amp; Reel SOT323-xL MECHANICAL DATA

DIM.	mm.			inch		
	MIN.	TYP	MAX.	MIN.	TYP.	MAX.
A	175	180	185	6.889	7.086	7.283
C	12.8	13	13.2	0.504	0.512	0.519
D	20.2			0.795		
N	59.5	60	60.5		2.362	
T			14.4			0.567
Ao		2.25			0.088	
Bo		2.7			0.106	
Ko		1.2			0.047	
Po	3.98	4	4.2	0.156	0.157	0.165
P	3.98	4	4.2	0.156	0.157	0.165

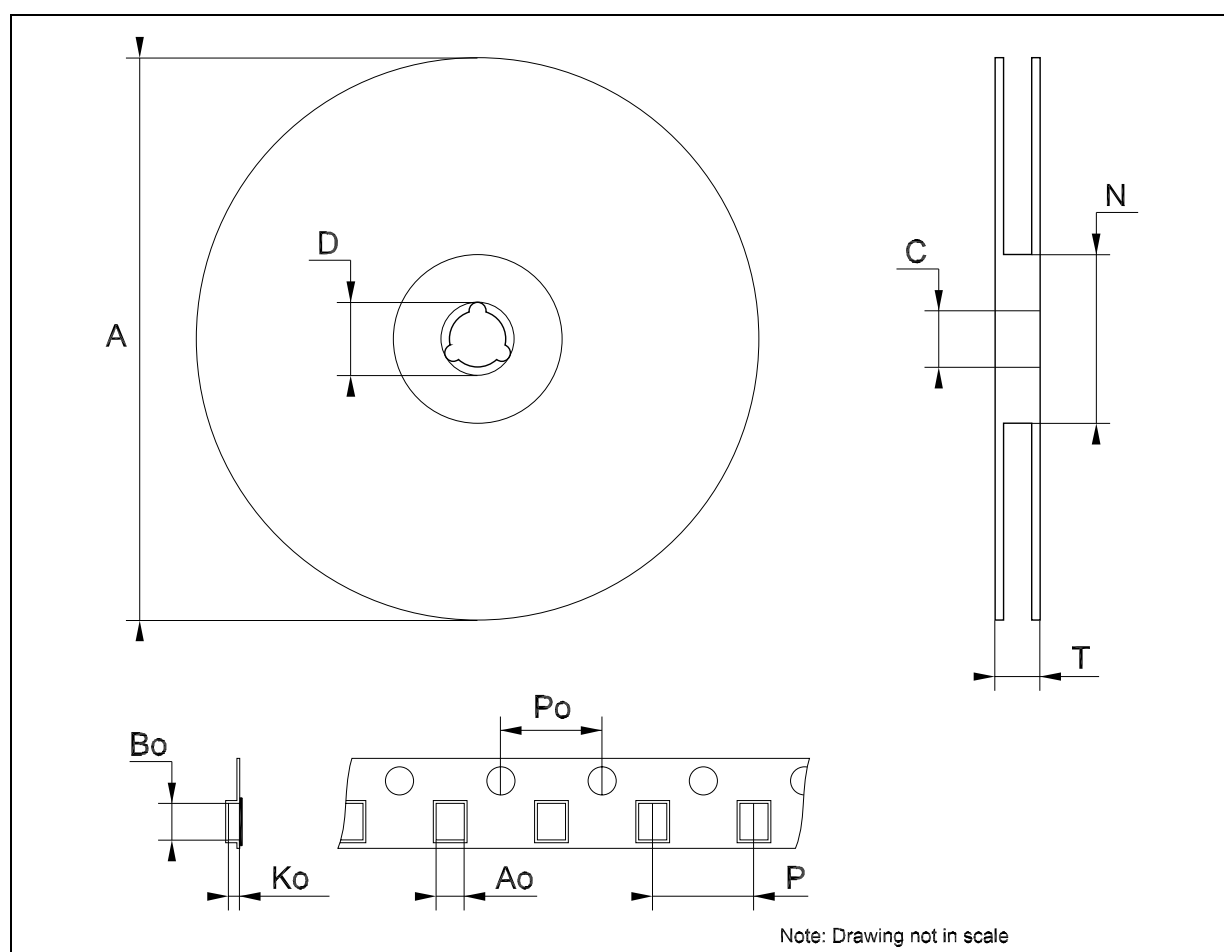



Information furnished is believed to be accurate and reliable. However, STMicroelectronics assumes no responsibility for the consequences of use of such information nor for any infringement of patents or other rights of third parties which may result from its use. No license is granted by implication or otherwise under any patent or patent rights of STMicroelectronics. Specifications mentioned in this publication are subject to change without notice. This publication supersedes and replaces all information previously supplied. STMicroelectronics products are not authorized for use as critical components in life support devices or systems without express written approval of STMicroelectronics.

© The ST logo is a registered trademark of STMicroelectronics

© 2001 STMicroelectronics - Printed in Italy - All Rights Reserved  
STMicroelectronics GROUP OF COMPANIES

Australia - Brazil - China - Finland - France - Germany - Hong Kong - India - Italy - Japan - Malaysia - Malta - Morocco  
Singapore - Spain - Sweden - Switzerland - United Kingdom

© <http://www.st.com>

