

### Features

(For  $V^+=5V$  and  $V^-=0V$  typical unless otherwise noted)

- Guaranteed 2.7V and 5V performance
- Crossover distortion eliminated
- Operating temperature range (-40°C to +85°C)
- Gain-bandwidth 1 MHz
- Low supply current
  - APX321 110  $\mu A$  Typ
  - APX358 190  $\mu A$  Typ
  - APX324 340  $\mu A$  Typ
- Rail-to-rail output swing @ 10 k $\Omega$ 
  - $V^+$  -10 mV
  - $V^-$  +10 mV
- Input Common Mode Voltage Range (0 to  $V^+-0.2V$ )
- Manufactured in standard CMOS process
- SOT353, SOT25, MSOP-8L, SOP-8L and TSSOP-14L:  
Available in "Green" Molding Compound (No Br, Sb)
- Lead-free Finish / RoHS Compliant (Note 4)

### General Description

The APX321/APX358/APX324 are low voltage (2.5V to 5.5V) single, dual and quad operational amplifiers. The APX321/APX358/APX324 are designed to effectively reduce cost and space at low voltage levels. These devices have the capability of rail-to-rail output swing and input common-mode voltage range. They can also achieve an efficient speed-to-power ratio, utilizing 1 MHz bandwidth and 1 V/ $\mu s$  slew rate at a low supply current. Reducing noise pickup and increasing signal integrity can be achieved by placing the device close to the signal source. The APX321 is available in 5-Pin SOT353/SOT25 packages that reduce space on pc boards and portable electronic devices. The APX324 is available in the TSSOP-14L package. The APX358 is available in the MSOP-8L and SOP-8L packages.

### Applications

- Active filters
- General purpose low voltage applications
- General purpose portable devices

### Ordering Information

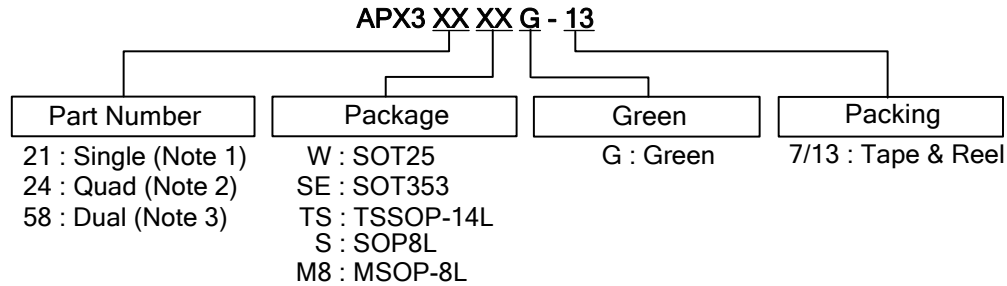

Device	Package Code	Packaging (Note 5)	7"/13" Tape and Reel	
			Quantity	Part Number Suffix
APX321WG-7	W	SOT25	3000/Tape & Reel	-7
APX321SEG-7	SE	SOT353	3000/Tape & Reel	-7
APX324TSG-13	TS	TSSOP-14L	2500/Tape & Reel	-13
APX358SG-13	S	SOP-8L	2500/Tape & Reel	-13
APX358M8G-13	M8	MSOP-8L	2500/Tape & Reel	-13

- Notes:
1. APX321 is only available for SOT25 and SOT353.
  2. APX324 is only available for TSSOP-14L.
  3. APX358 is only available for SOP-8L and MSOP-8L.
  4. EU Directive 2002/95/EC (RoHS). All applicable RoHS exemptions applied. Please visit our website at [http://www.diodes.com/products/lead\\_free.html](http://www.diodes.com/products/lead_free.html)
  5. Pad layout as shown on Diodes Inc. suggested pad layout document AP02001, which can be found on our website at <http://www.diodes.com/datasheets/ap02001.pdf>.

**Pin Assignments**

(1) SOT25 / SOT353

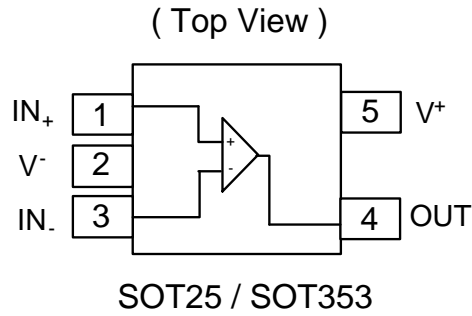

(2) SOP-8L / MSOP-8L

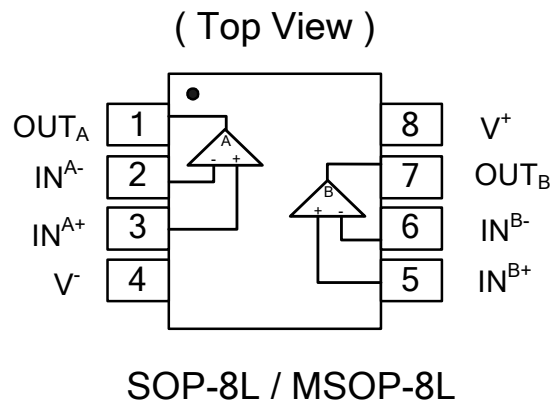

(3) TSSOP-14L

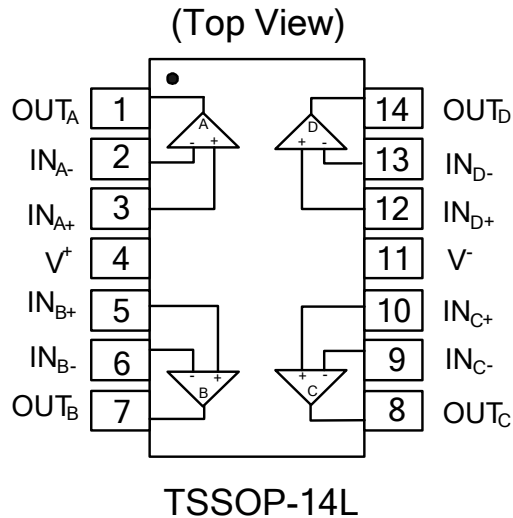

### Absolute Maximum Ratings (Note 6)

Symbol	Description	Rating	Unit	
ESD HBM	Human Body Model ESD Protection	APX321	4000	V
		APX358	4000	
		APX324	4500	
ESD MM	Machine Model ESD Protection	APX321	350	V
		APX358	350	
		APX324	250	
	Differential Input Voltage	$\pm$ Supply Voltage	V	
$V^+ - V^-$	Supply Voltage	5.5	V	
	Output Short Circuit to $V^+$	(Note 7)		
	Output Short Circuit to $V^-$	(Note 8)		
$T_{ST}$	Storage Temperature	-65 to 150	$^{\circ}$ C	
$T_J$	Maximum Junction Temperature	150	$^{\circ}$ C	

### Operating Ratings (Note 6)

Symbol	Description	Rating	Unit
$V^+ - V^-$	Supply Voltage	2.5 to 5.5	V
$T_A$	Operating Ambient Temperature Range	-40 to +85	$^{\circ}$ C

Notes: 6. Absolute Maximum Ratings indicate limits beyond which damage to the device may occur. Operating Ratings indicate conditions for which the device is intended to be functional, but specific performance is not guaranteed. For guaranteed specifications and the test conditions, see the Electrical Characteristics.

### Electrical Characteristics

#### 2.7V DC Electrical Characteristics

Unless otherwise specified, all limits guaranteed for  $T_A = 25^\circ\text{C}$ ,  $V^+ = 2.7\text{V}$ ,  $V^- = 0\text{V}$ ,  $V_{CM} = 1.0\text{V}$ ,  $V_O = V^+/2$  and  $R_L > 1\text{M}\Omega$ .

Symbol	Parameter	Test Conditions	Min (Note 10)	Typ. (Note 9)	Max (Note 10)	Unit
$V_{OS}$	Input Offset Voltage			1.7	7	mV
$TCV_{OS}$	Input Offset Voltage Average Drift			5		$\mu\text{V}/^\circ\text{C}$
$I_B$	Input Bias Current			10		nA
$I_{OS}$	Input Offset Current			5	50	nA
CMRR	Common Mode Rejection Ratio	$0\text{V} \leq V_{CM} \leq 2.4\text{V}$	50	63		dB
PSRR	Power Supply Rejection Ratio	$2.7\text{V} \leq V^+ \leq 5\text{V}$ $V_O = 1\text{V}$	50	60		dB
$V_{CMR}$	Input Common-Mode Voltage Range	For CMRR $\geq 50\text{dB}$	0	-0.2	2.5	V
$V_O$	Output Swing	$R_L = 10\text{ k}\Omega$ to $1.35\text{V}$	$V^+ - 100$	$V^+ - 20$ 20	100	mV
$I_S$	Supply Current	APX321 Single amplifier		110	140	$\mu\text{A}$
		APX358 Both amplifiers		190	340	$\mu\text{A}$
		APX324 All four amplifiers		340	680	$\mu\text{A}$

#### 2.7V AC Electrical Characteristics

Unless otherwise specified, all limits guaranteed for  $T_A = 25^\circ\text{C}$ ,  $V^+ = 2.7\text{V}$ ,  $V^- = 0\text{V}$ ,  $V_{CM} = 1.0\text{V}$ ,  $V_O = V^+/2$  and  $R_L > 1\text{M}\Omega$ .

Symbol	Parameter	Test Conditions	Min (Note 10)	Typ. (Note 9)	Max (Note 10)	Unit
GBWP	Gain-Bandwidth Product	$C_L = 200\text{ pF}$		1		MHz
$\phi_m$	Phase Margin			60		Deg
Gm	Gain Margin			10		dB
$e_n$	Input-Referred Voltage Noise	$f > 50\text{ KHz}$		23		$\frac{\text{nV}}{\sqrt{\text{Hz}}}$

### Electrical Characteristics (Continued)

#### 5V DC Electrical Characteristics

Unless otherwise specified, all limits guaranteed for  $T_A = 25^\circ\text{C}$ ,  $V^+ = 5\text{V}$ ,  $V^- = 0\text{V}$ ,  $V_{\text{CM}} = 2.0\text{V}$ ,  $V_O = V^+/2$  and  $R_L > 1\text{M}\Omega$ . **Boldface** limits apply at the temperature extremes.

Symbol	Parameter	Test Conditions	Min (Note 10)	Typ. (Note 9)	Max (Note 10)	Unit
$V_{\text{OS}}$	Input Offset Voltage			1.7	<b>7</b> <b>9</b>	mV
$\text{TCV}_{\text{OS}}$	Input Offset Voltage Average Drift			5		$\mu\text{V}/^\circ\text{C}$
$I_B$	Input Bias Current			15	250 <b>500</b>	nA
$I_{\text{OS}}$	Input Offset Current			5	50 <b>150</b>	nA
CMRR	Common Mode Rejection Ratio	$0\text{V} \leq V_{\text{CM}} \leq 4.7\text{V}$	50	65		dB
PSRR	Power Supply Rejection Ratio	$2.7\text{V} \leq V^+ \leq 5\text{V}$ $V_O = 1\text{V}$ , $V_{\text{CM}} = 1\text{V}$	50	60		dB
$V_{\text{CMR}}$	Input Common-Mode Voltage Range	For CMRR $\geq 50\text{dB}$	0	-0.2	4.8	V
$A_V$	Large Signal Voltage Gain	$R_L = 2\text{ k}\Omega$ (Note 11)	15 <b>10</b>	100		V/mV
$V_O$	Output Swing	$R_L = 2\text{ k}\Omega$ to 2.5V	$V^+ - 300$ <b><math>V^+ - 400</math></b>	$V^+ - 50$		mV
				50	300 <b>400</b>	mV
		$R_L = 10\text{ k}\Omega$ to 2.5V	$V^+ - 100$ <b><math>V^+ - 200</math></b>	$V^+ - 10$		mV
				10	180 <b>280</b>	mV
$I_O$	Output Short Circuit Current	Sourcing, $V_O = 0\text{V}$	5	60		mA
		Sinking, $V_O = 5\text{V}$	10	90		mA
$I_S$	Supply Current	APX321 Single amplifier		110	140	$\mu\text{A}$
		APX358 Both amplifiers		190	340 <b>600</b>	$\mu\text{A}$
		APX324 All four amplifiers		340	680 <b>1100</b>	$\mu\text{A}$
$\theta_{\text{JA}}$	Thermal Resistance Junction-to-Ambient	SOT353 (Note 12)		330		$^\circ\text{C}/\text{W}$
		SOT25 (Note 12)		250		$^\circ\text{C}/\text{W}$
		TSSOP-14L (Note 12)		100		$^\circ\text{C}/\text{W}$
		MSOP-8L (Note 12)		203		$^\circ\text{C}/\text{W}$
		SOP-8L (Note 12)		150		$^\circ\text{C}/\text{W}$

### Electrical Characteristics (Continued)

#### 5V AC Electrical Characteristics

Unless otherwise specified, all limits guaranteed for  $T_A = 25^\circ\text{C}$ ,  $V^+ = 5\text{V}$ ,  $V^- = 0\text{V}$ ,  $V_{\text{CM}} = 2.0\text{V}$ ,  $V_O = V^+/2$  and  $R_L > 1\text{M}\Omega$ . **Boldface** limits apply at the temperature extremes.

Symbol	Parameter	Test Conditions	Min (Note 10)	Typ. (Note 9)	Max (Note 10)	Unit
SR	Slew Rate	(Note 13)		1		V/ $\mu\text{s}$
GBWP	Gain-Bandwidth Product	$C_L = 200\text{ pF}$		1		MHz
$\Phi_m$	Phase Margin			60		Deg
$G_m$	Gain Margin			10		dB
$e_n$	Input-Referred Voltage Noise	$f > 50\text{ KHz}$		23		$\frac{\text{nV}}{\sqrt{\text{Hz}}}$

- Notes:
7. Shorting output to  $V^+$  will adversely affect reliability.
  8. Shorting output to  $V^-$  will adversely affect reliability.
  9. Typical values represent the most likely parametric norm as determined at the time of characterization. Actual typical values may vary over time and will also depend on the application and configuration. The typical values are not tested and are not guaranteed on shipped production material.
  10. All limits are guaranteed by testing or statistical analysis.
  11.  $R_L$  is connected to  $V^-$ . The output voltage is  $0.5\text{V} \leq V_O \leq 4.5\text{V}$ .
  12. All numbers are typical, and apply for packages soldered directly onto a PC board in still air.
  13. Connected as voltage follower with 3V step input. Number specified is the slower of the positive and negative slew rates.

### Typical Performance Characteristics

Unless otherwise specified,  $V_s = +5V$ , single supply,  $T_A = 25^\circ C$

**Supply Current vs. Supply Voltage**

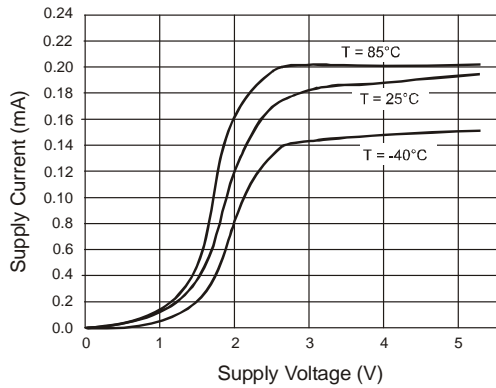

**Output Voltage Swing vs. Supply Voltage**

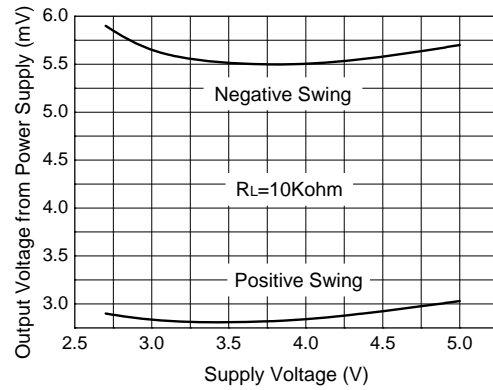

**PSRR vs. Frequency**

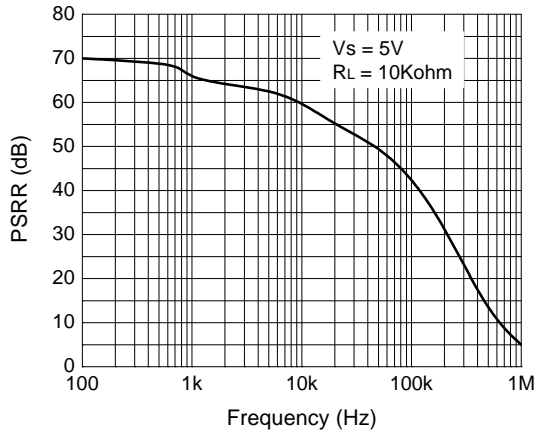

**CMRR vs. Frequency**

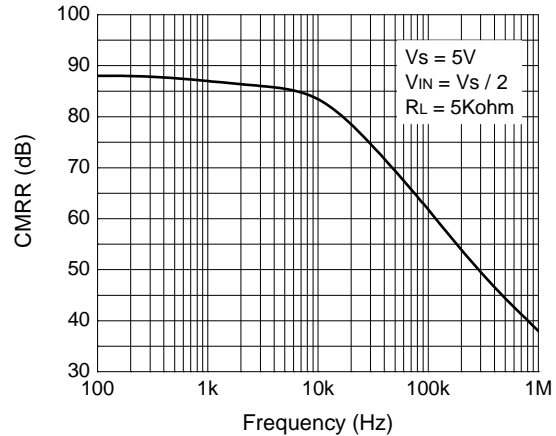

**CMRR vs. Input Common Mode Voltage**

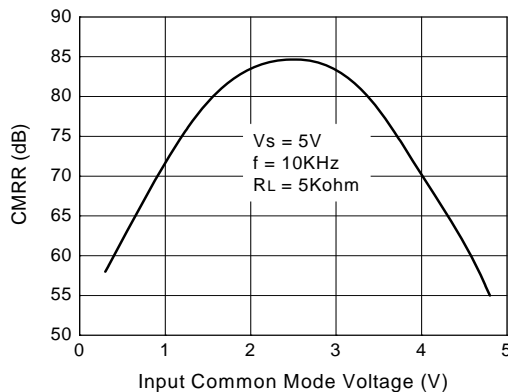

**$\Delta V_{os}$  vs. CMR**

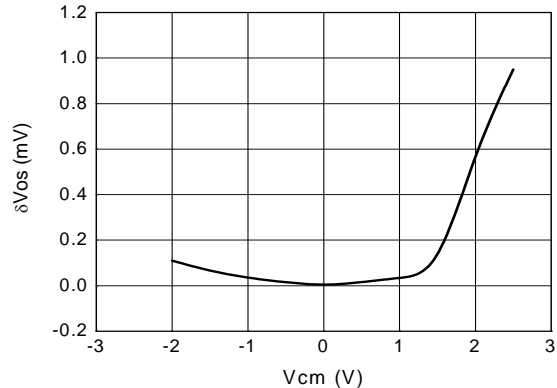

**Typical Performance Characteristics (Continued)**

**Sourcing Current vs. Output Voltage (2.7V)**

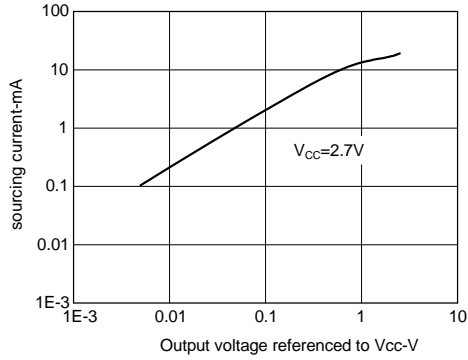

**Sourcing Current vs. Output Voltage (5V)**

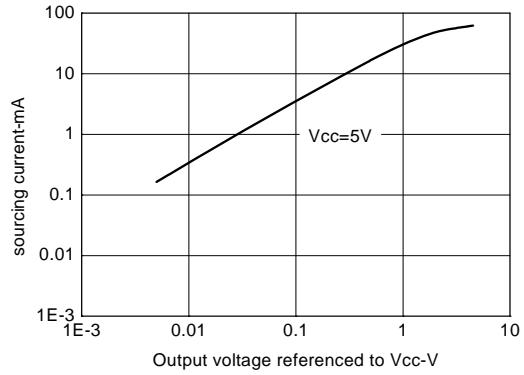

**Sinking Current vs. Output Voltage (2.7V)**

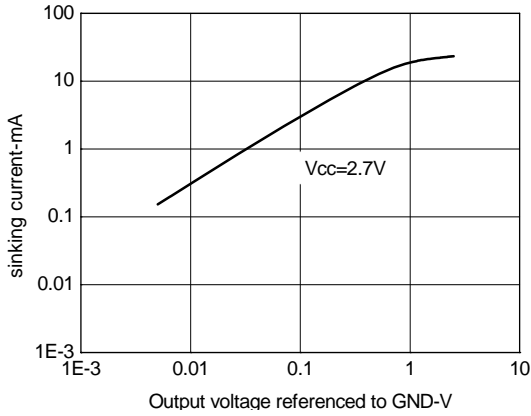

**Sinking Current vs. Output Voltage (5V)**

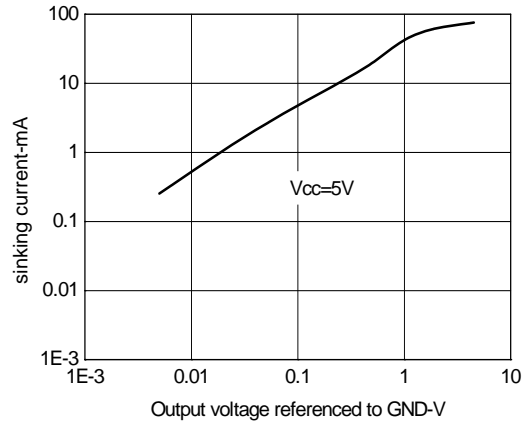

**Input Voltage vs. Output Voltage**

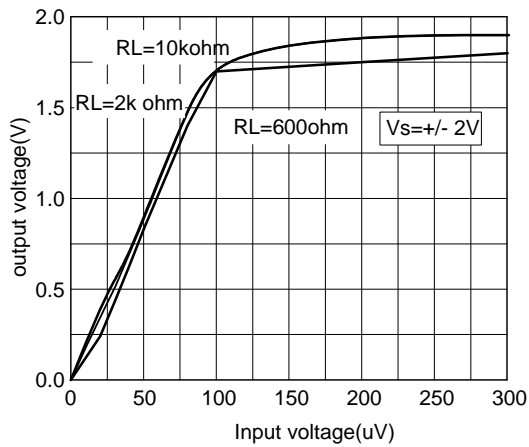



**Typical Performance Characteristics (Continued)**

**Frequency Response vs. Resistive Load (2.7V)**

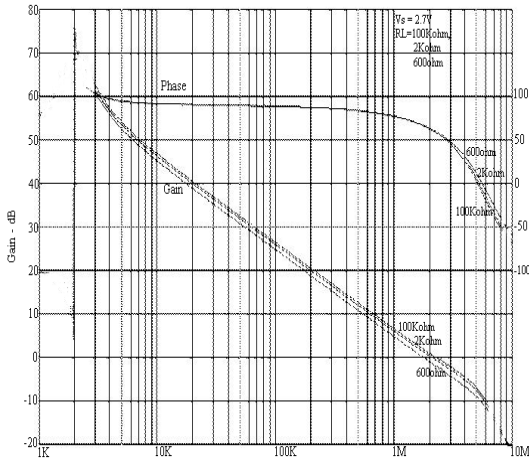

**Frequency Response vs. Resistive Load (5V)**

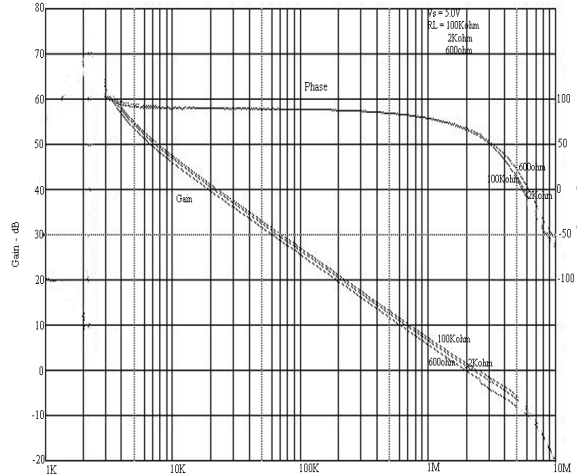

**Frequency Response vs. Capacitive Load (2.7V)**

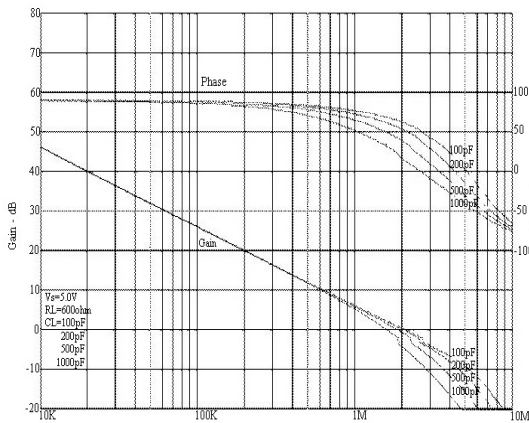

**Frequency Response vs. Capacitive Load (5V)**

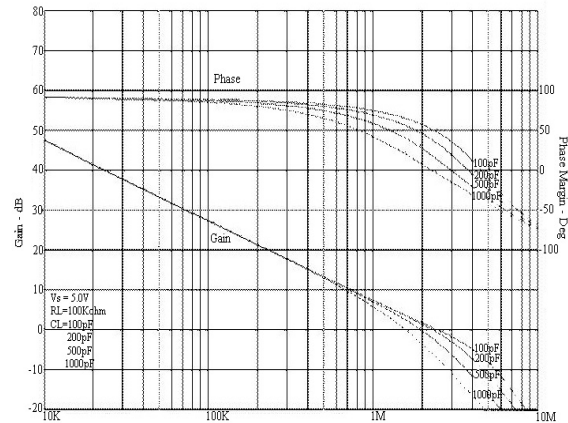

**Non-Inverting Large Signal Pulse Response**

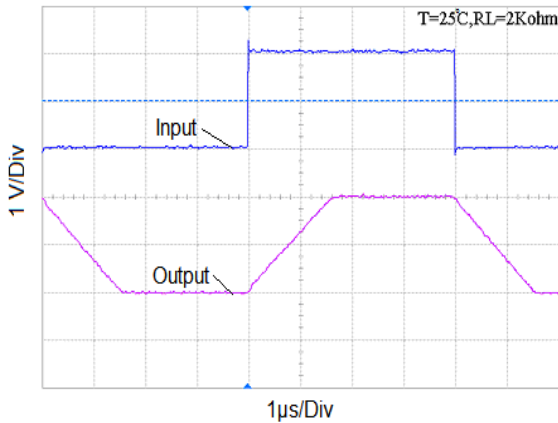

**Non-Inverting Large Signal Pulse Response**

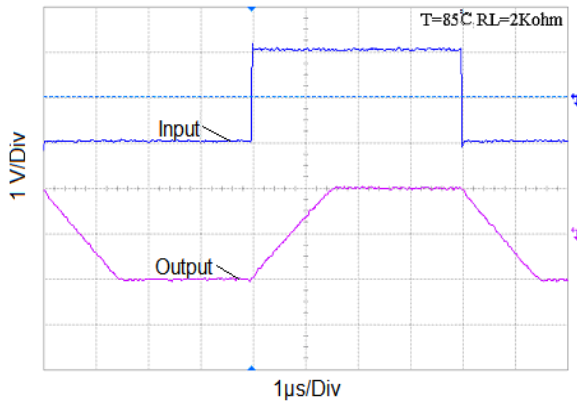

**Typical Performance Characteristics (Continued)**

**Non-Inverting Large Signal Pulse Response**

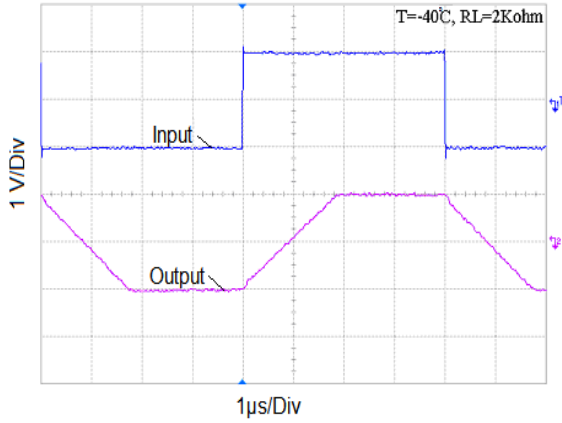

**Non-Inverting Small Signal Pulse Response**

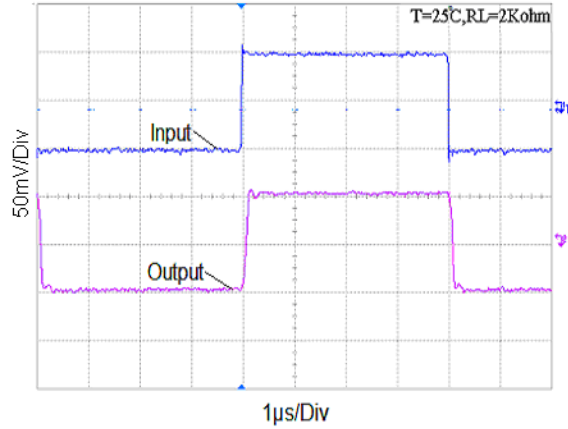

**Non-Inverting Small Signal Pulse Response**

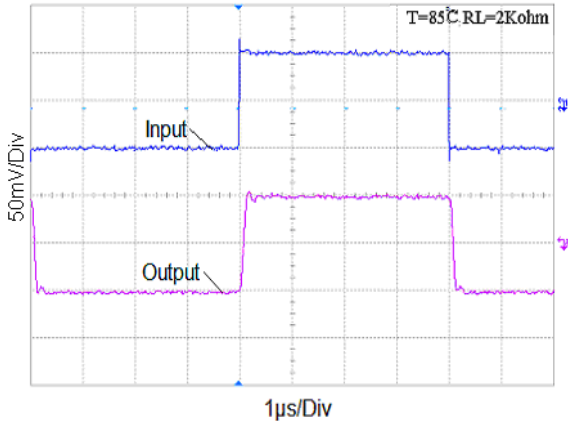

**Non-Inverting Small Signal Pulse Response**

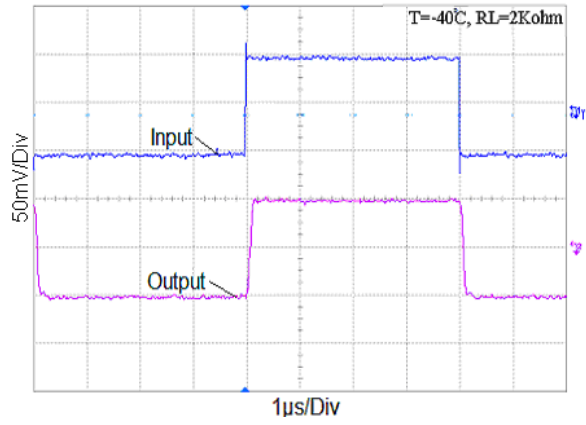

**Inverting Large Signal Pulse Response**

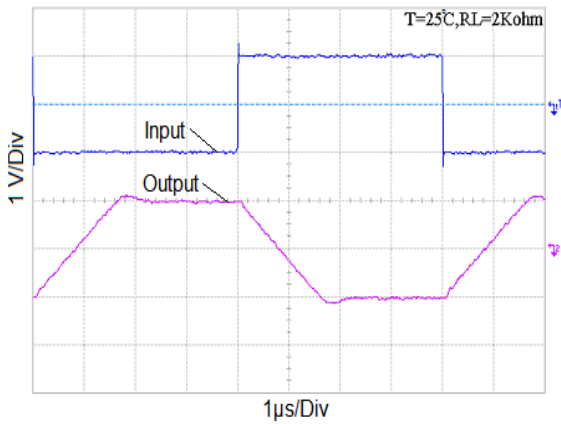

**Inverting Large Signal Pulse Response**

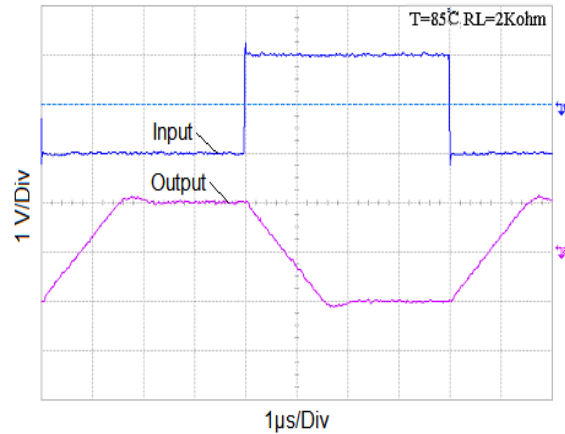

**Typical Performance Characteristics (Continued)**

**Inverting Large Signal Pulse Response**

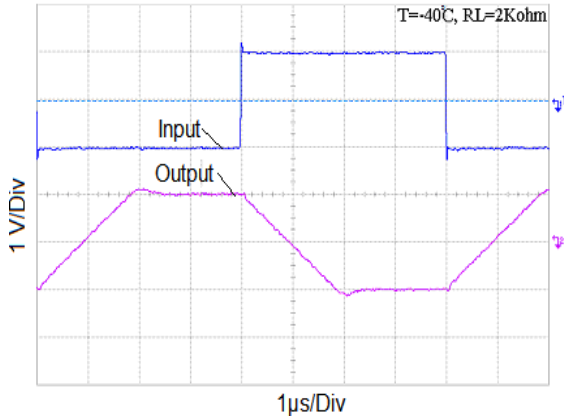

**Inverting Small Signal Pulse Response**

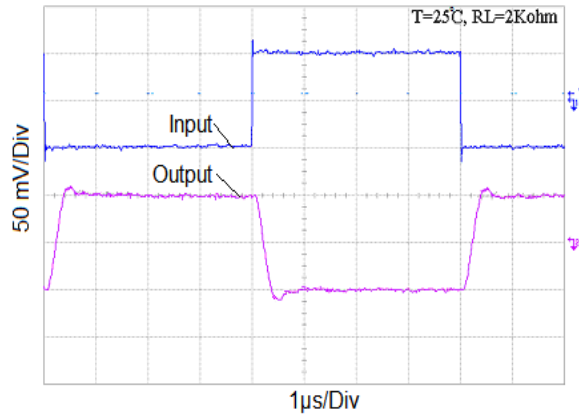

**Inverting Small Signal Pulse Response**

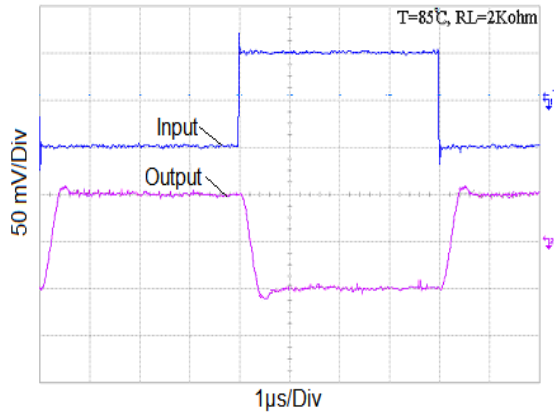

**Inverting Small Signal Pulse Response**

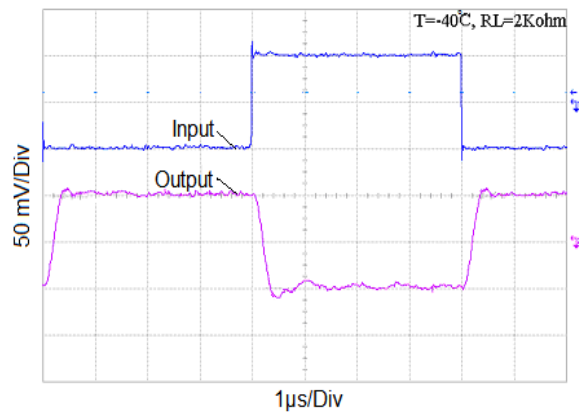

**Stability vs. Capacitive Load**

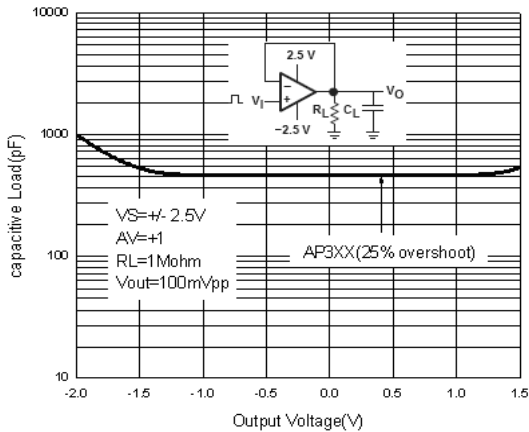

**Stability vs. Capacitive Load**

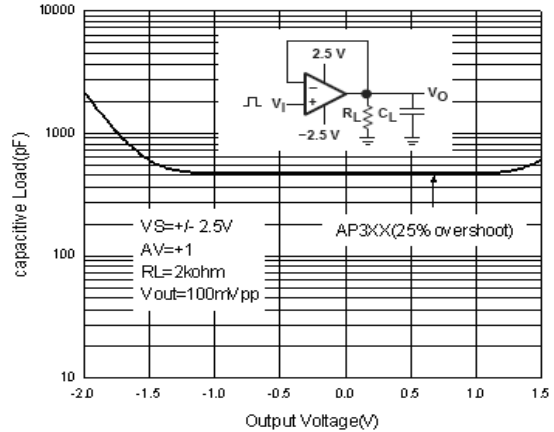

**Typical Performance Characteristics (Continued)**

**Stability vs. Capacitive Load**

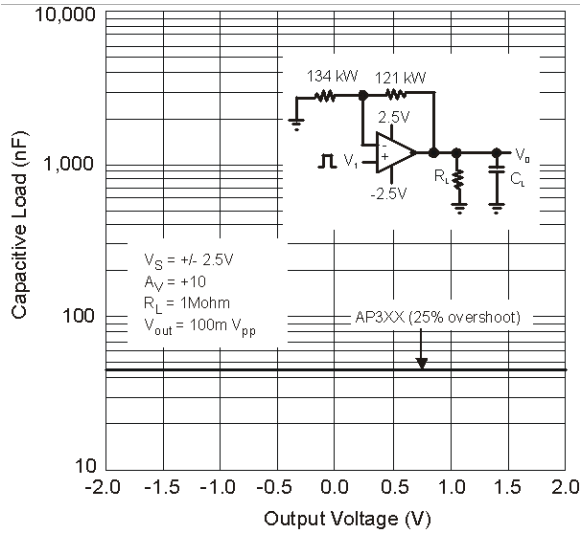

**Stability vs. Capacitive Load**

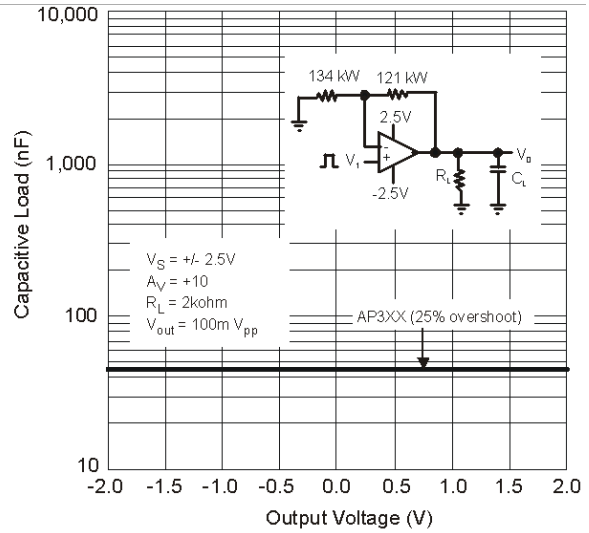

**Slew Rate vs. Supply Voltage**

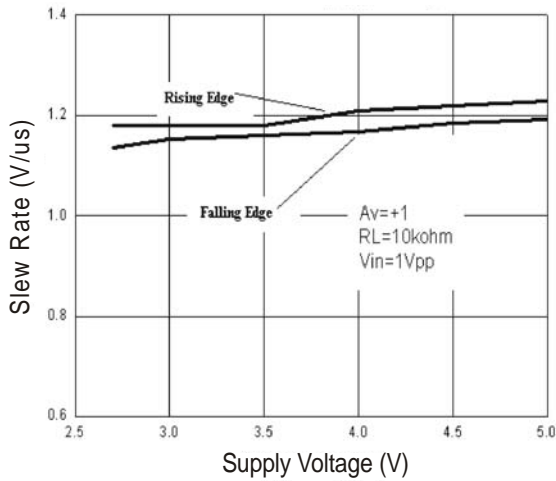

**Input Voltage Noise**

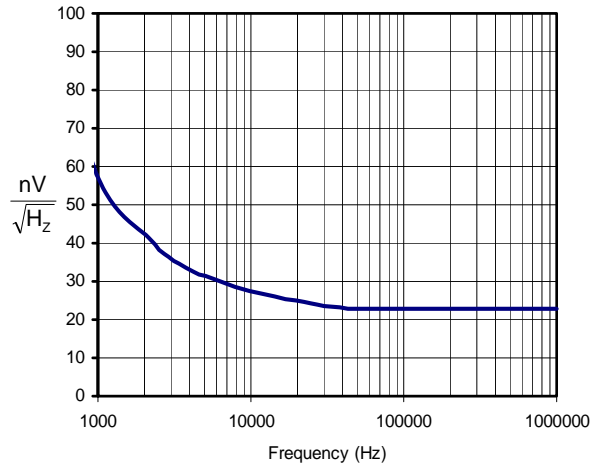

**Typical Performance Characteristics (Continued)**

**Input Voltage Noise (2.7V)**

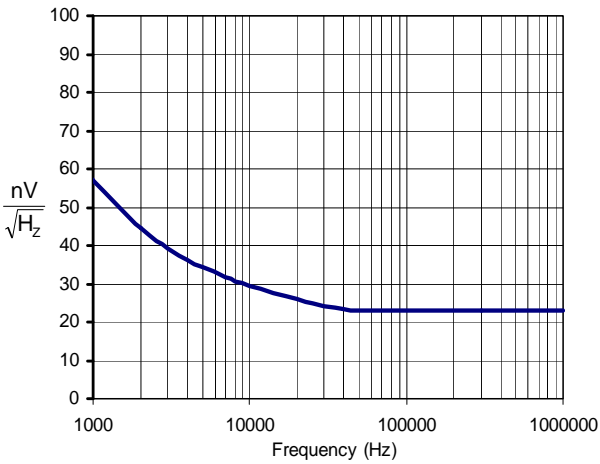

### Marking Information

#### (1) SOT25 / SOT353

( Top View )

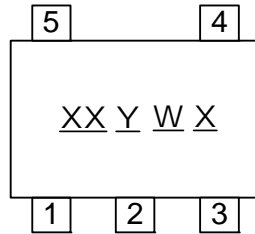

XX : Identification code  
Y : Year 0~9  
W : Week : A~Z : 1~26 week;  
 a~z : 27~52 week; z represents  
 52 and 53 week  
X : A~Z : Green

Device	Package type	Identification Code
APX321W	SOT25	V2
APX321SE	SOT353	V3

#### (2) TSSOP-14L

( Top View )

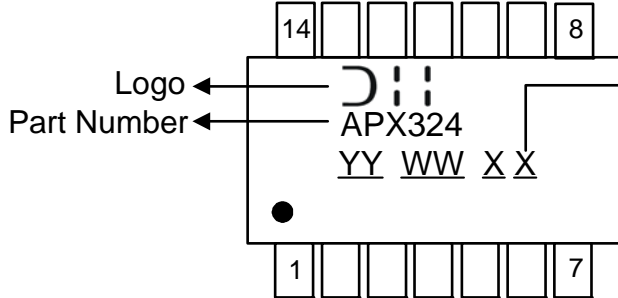

G : Green  
YY : Year : 08, 09,10~  
WW : Week : 01~52; 52  
 represents 52 and 53 week  
X : Internal Code

#### (3) SOP-8L

( Top View )

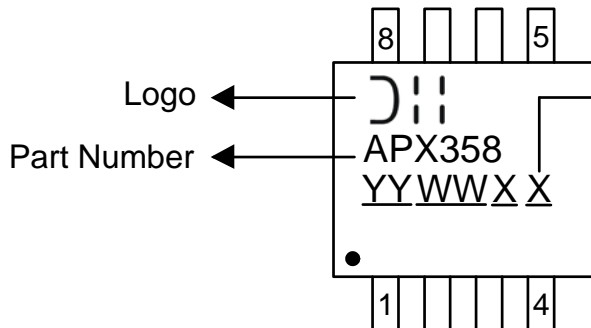

G : Green  
YY : Year : 08, 09,10~  
WW : Week : 01~52; 52  
 represents 52 and 53 week  
X : Internal Code

### Marking Information (Continued)

#### (4) MSOP-8L

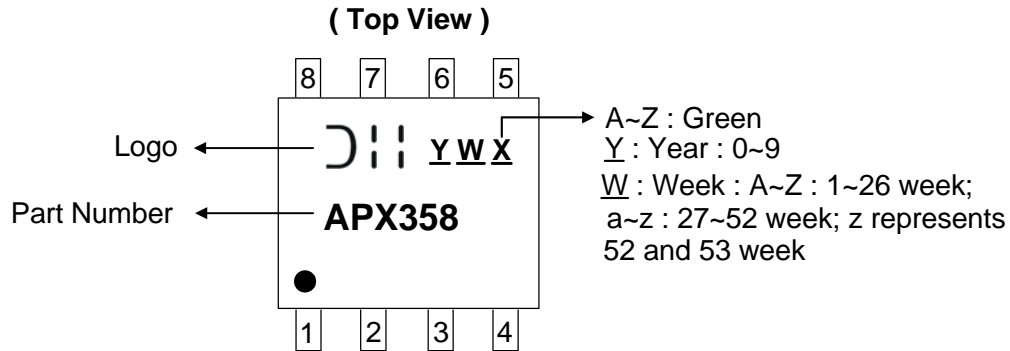

### Package Information (All Dimensions in mm)

#### (1) Package Type: SOT25

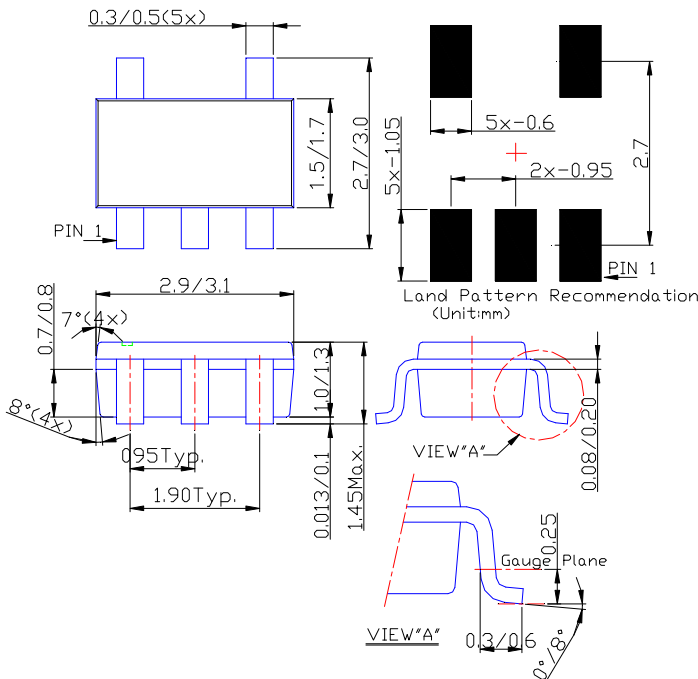

**Package Information (Continued)**

**(2) Package Type: SOT353**

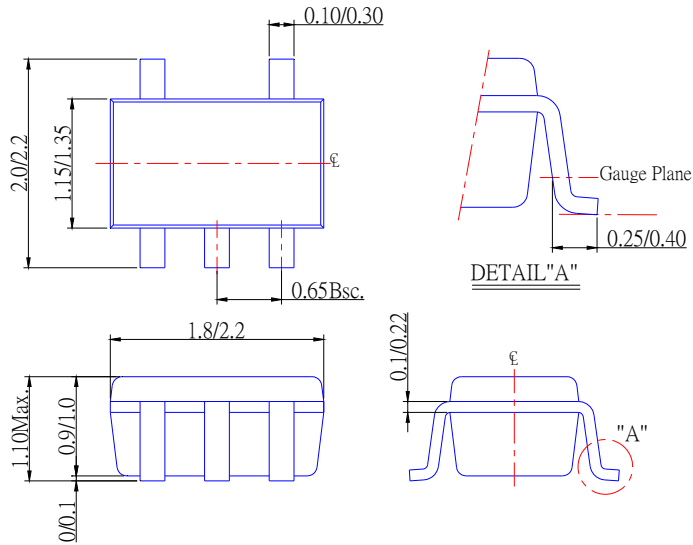

**(3) Package Type: TSSOP-14L**

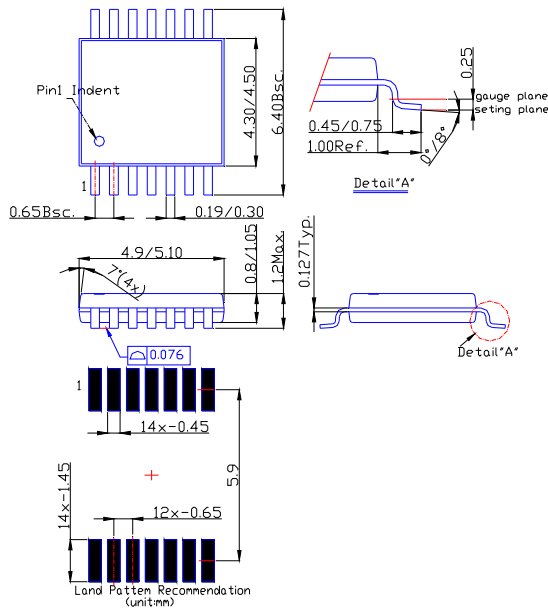



**Package Information (Continued)**

**(4) Package Type: SOP-8L**

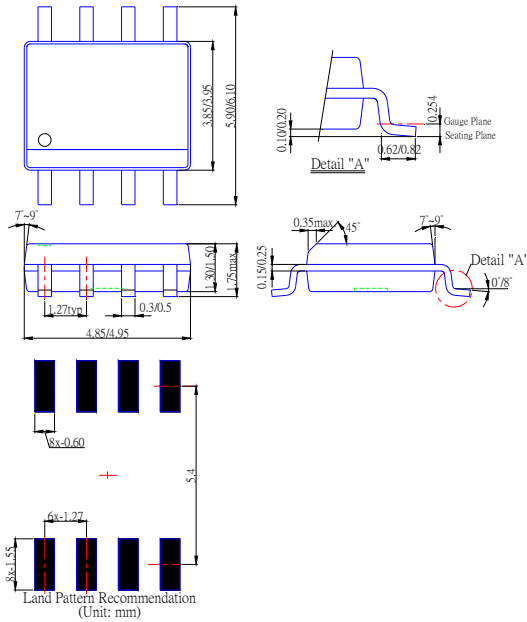

**(5) Package Type: MSOP-8L**

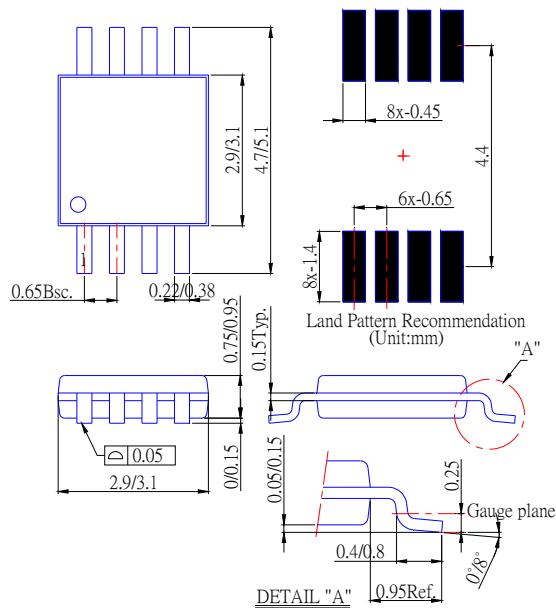



# APX321/APX358/APX324

## LOW VOLTAGE, RAIL-TO-RAIL INPUT AND OUTPUT SINGLE/DUAL/QUAD OPERATIONAL AMPLIFIERS

### IMPORTANT NOTICE

Diodes Incorporated and its subsidiaries reserve the right to make modifications, enhancements, improvements, corrections or other changes without further notice to any product herein. Diodes Incorporated does not assume any liability arising out of the application or use of any product described herein; neither does it convey any license under its patent rights, nor the rights of others. The user of products in such applications shall assume all risks of such use and will agree to hold Diodes Incorporated and all the companies whose products are represented on our website, harmless against all damages.

### LIFE SUPPORT

Diodes Incorporated products are not authorized for use as critical components in life support devices or systems without the expressed written approval of the President of Diodes Incorporated.