

ON Semiconductor

Is Now

onsemi™

To learn more about onsemi™, please visit our website at
www.onsemi.com

onsemi and **onsemi** and other names, marks, and brands are registered and/or common law trademarks of Semiconductor Components Industries, LLC dba "**onsemi**" or its affiliates and/or subsidiaries in the United States and/or other countries. **onsemi** owns the rights to a number of patents, trademarks, copyrights, trade secrets, and other intellectual property. A listing of **onsemi** product/patent coverage may be accessed at www.onsemi.com/site/pdf/Patent-Marking.pdf. **onsemi** reserves the right to make changes at any time to any products or information herein, without notice. The information herein is provided "as-is" and **onsemi** makes no warranty, representation or guarantee regarding the accuracy of the information, product features, availability, functionality, or suitability of its products for any particular purpose, nor does **onsemi** assume any liability arising out of the application or use of any product or circuit, and specifically disclaims any and all liability, including without limitation special, consequential or incidental damages. Buyer is responsible for its products and applications using **onsemi** products, including compliance with all laws, regulations and safety requirements or standards, regardless of any support or applications information provided by **onsemi**. "Typical" parameters which may be provided in **onsemi** data sheets and/or specifications can and do vary in different applications and actual performance may vary over time. All operating parameters, including "Typicals" must be validated for each customer application by customer's technical experts. **onsemi** does not convey any license under any of its intellectual property rights nor the rights of others. **onsemi** products are not designed, intended, or authorized for use as a critical component in life support systems or any FDA Class 3 medical devices or medical devices with a same or similar classification in a foreign jurisdiction or any devices intended for implantation in the human body. Should Buyer purchase or use **onsemi** products for any such unintended or unauthorized application, Buyer shall indemnify and hold **onsemi** and its officers, employees, subsidiaries, affiliates, and distributors harmless against all claims, costs, damages, and expenses, and reasonable attorney fees arising out of, directly or indirectly, any claim of personal injury or death associated with such unintended or unauthorized use, even if such claim alleges that **onsemi** was negligent regarding the design or manufacture of the part. **onsemi** is an Equal Opportunity/Affirmative Action Employer. This literature is subject to all applicable copyright laws and is not for resale in any manner. Other names and brands may be claimed as the property of others.

Dual Operational Amplifier, 7 MHz Bandwidth with Shutdown

NCS20282

The NCS20282 high precision op amp features a wide bandwidth along with shutdown. These amplifiers provide low bias current useful for transimpedance applications. The wide bandwidth eases the design of active filters. The NCS20282 is specified for operation from -40°C to $+125^{\circ}\text{C}$.

Features

- High Bandwidth: 7 MHz typical
- Low Bias Current: 50 pA typical
- Rail-to-Rail Input/Output
- Shutdown Current: 1 μA max
- Offset Voltage: 1.5 mV max
- Offset Drift: 10 $\mu\text{V}/^{\circ}\text{C}$ max
- Supply Voltage: 2.5 V to 5.5 V
- These Devices are Pb-free, Halogen Free/BFR Free and are RoHS Compliant

Typical Applications

- Transducer Applications
- Sensor Conditioning
- Medical Instrumentation
- Impedance Sensing

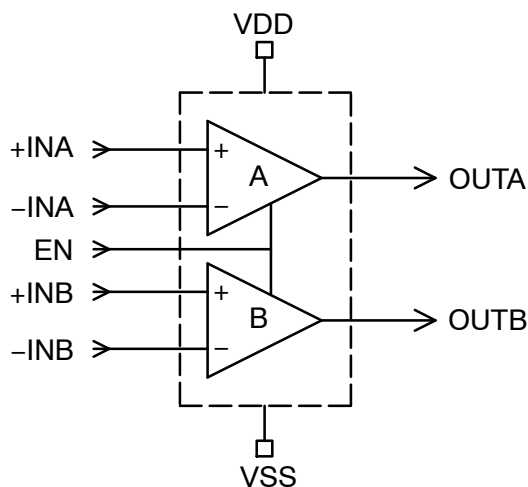

ON Semiconductor®

www.onsemi.com



WLCSP9
CASE 567UW



WLCSP9
CASE 567YD

MARKING DIAGRAM

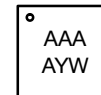

AAA = Specific Device Code
A = Assembly Location
Y = Year
W = Work Week

(Note: Microdot may be in either location)

PIN CONNECTIONS

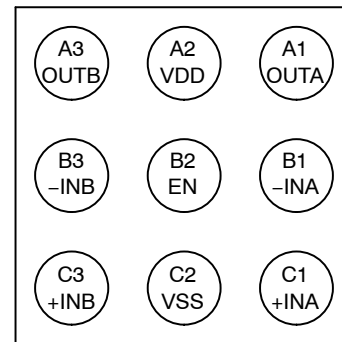

Package Bottom View (Bump Up)

ORDERING INFORMATION

See detailed ordering, marking and shipping information in the package dimensions section on page 9 of this data sheet.

This document contains information on some products that are still under development. ON Semiconductor reserves the right to change or discontinue these products without notice.

NCS20282

Table 1. ABSOLUTE MAXIMUM RATINGS Over operating free-air temperature, unless otherwise stated.

Parameter	Rating	Unit
Supply Voltage (VDD - VSS)	7	V
INPUT AND OUTPUT PINS		
Input Voltage (Note 1)	(V _{SS} - 0.5) to 7	V
Input Current (Note 1)	±5	mA
Output Pin Voltage, Disabled	7	V
Output Short Circuit Current (Note 2)	Continuous	
TEMPERATURE		
Operating Temperature	-40 to +125	°C
Storage Temperature	-65 to +150	°C
Junction Temperature	+150	°C
ESD RATINGS (Note 3)		
Human Body Model (HBM)	2000	V
Charged Device Model (CDM)	1000	V
OTHER RATINGS		
Latch-up Current (Note 4)	100	mA
MSL	Level 1	

Stresses exceeding those listed in the Maximum Ratings table may damage the device. If any of these limits are exceeded, device functionality should not be assumed, damage may occur and reliability may be affected.

1. The input voltage at any pin may exceed the voltage shown if the current at that pin is limited to 5 mA.
2. Short-circuit to ground.
3. This device series incorporates ESD protection and is tested by the following methods:
 ESD Human Body Model tested per JEDEC standard JS-001-2017
 ESD Charged Device Model tested per JEDEC standard JS-002-2014
4. Latch-up Current tested per JEDEC standard: JESD78

Table 2. THERMAL INFORMATION

Parameter	Symbol	Cu Area mm ²	1.0 oz	2.0 oz	Unit
Thermal Resistance Junction to Ambient	Θ_{JA}	10	301	263	°C/W
		25	263	230	
		40	246	215	
		80	229	204	
		140	220	196	
		250	211	188	
		350	206	183	
		500	200	179	
		650	197	175	
		800	194	173	

NOTE: Four layer JSEC JESD51-7

Table 3. OPERATING CONDITIONS

Parameter	Symbol	Range	Units
Supply Voltage (V _{DD} - V _{SS})	V _S	2.5 to 5.5	V
Specified Operating Temperature Range	T _A	-40 to +125	°C
Input Common Mode Voltage Range	V _{CM}	V _{SS} to V _{DD}	V

Functional operation above the stresses listed in the Recommended Operating Ranges is not implied. Extended exposure to stresses beyond the Recommended Operating Ranges limits may affect device reliability.

NCS20282

Table 4. ELECTRICAL CHARACTERISTICS: $V_S = 2.5\text{ V to }5.5\text{ V}$

At $T_A = +25^\circ\text{C}$, $R_L = 10\text{ k}\Omega$, $V_{CM} = V_{OUT} = \text{midsupply}$, Enable input connected to V_{DD} , unless otherwise noted.

Boldface limits apply over the specified temperature range, $T_A = -40^\circ\text{C to }+125^\circ\text{C}$, guaranteed by characterization and/or design.

Parameter	Symbol	Conditions	Min	Typ	Max	Units
INPUT CHARACTERISTICS						
Offset Voltage	V_{OS}			300	1500	μV
Offset Voltage Drift vs Temp	$\Delta V_{OS}/\Delta T$			2	10	$\mu\text{V}/^\circ\text{C}$
Input Bias Current (Note 5)	I_{IB}			50	800	pA
Input Offset Current	I_{OS}			10		pA
Input Common-Mode Voltage Range	V_{CM}			V_{SS} to V_{DD}		V
Common Mode Rejection Ratio	CMRR	$V_{CM} = -0.1\text{ V to } (V_{DD}+0.1\text{ V})$	66	86		dB
Input Resistance	R_{IN}	Differential		10		G Ω
		Common Mode		10		
Input Capacitance	C_{IN}	Differential		2		pF
		Common Mode		5		

OUTPUT CHARACTERISTICS

Open Loop Voltage Gain	A_{VOL}	$0.4\text{ V} \leq V_{OUT} \leq V_{DD} - 0.4\text{ V}$	96	116		dB
Closed Loop Output Impedance	Z_{OUT_CL}	See Figure 23		See Figure 23		Ω
Output Voltage High, Referenced to V_{DD}	V_{OH}			$V_{DD}-3$	$V_{DD}-10$	mV
Output Voltage Low, Referenced to V_{SS}	V_{OL}			$V_{SS}+6$	$V_{SS}+10$	mV
Short Circuit Current (Note 5)	I_{SC}	Sinking Current		10	15	mA
		Sourcing Current		10	15	
Capacitive Load Drive (Note 5)	C_L			100	300	pF

DYNAMIC PERFORMANCE

Gain Bandwidth Product (Note 5)	GBW	$V_S = 3\text{ V};$ $R_L = 10\text{ k}\Omega, C_L = 100\text{ pF}$	5.4	7		MHz
Gain Margin	A_M	$C_L = 100\text{ pF}$		50		dB
Phase Margin	Ψ_M	$C_L = 100\text{ pF}$		55		$^\circ$
Slew Rate	SR	$A_V = +1$		5		V/ μs
Overload Recovery Time	t_{OR}	$V_{IN} \times A_V > V_S$		1		μs

NOISE PERFORMANCE

Voltage Noise Density	e_N	$f_{IN} = 10\text{ kHz}$		20		nV/ $\sqrt{\text{Hz}}$
Current Noise Density	i_N	$f_{IN} = 1\text{ Hz}$		300		fA/ $\sqrt{\text{Hz}}$

POWER SUPPLY

Power Supply Rejection Ratio	PSRR		90	120		dB	
Shutdown Enable Time (Notes 5, 6)	t_{ON}			30	50	μs	
Shutdown Disable Time (Note 6)	t_{OFF}			30		μs	
Shutdown Leakage	Input	$V_{IN} = V_S + 400\text{ mV}$			500	nA	
	Output	$V_{OUT} = V_S + 1\text{ V}$			500		
Enable Input Threshold Voltage	$V_{th(EN)}$	Operating	1.3			V	
		Disabled			0.5		
Enable Input Leakage Current	I_{Enable}	Enable = + 5.0 V		1.1		μA	
		Enable = V_{SS}		1.1			
Quiescent Current	I_Q	Per Channel No load	Quiescent		850	1300	μA
			Shutdown		0.3	1	

5. Guaranteed by design and/or characterization

6. Shutdown Disable Time (t_{OFF}) and Enable Time (t_{ON}) are defined as the time between the 50% point of the signal applied to the EN pin and the point at which the output voltage reaches the 10% (disable) or 90% (enable) level.

Product parametric performance is indicated in the Electrical Characteristics for the listed test conditions, unless otherwise noted. Product performance may not be indicated by the Electrical Characteristics if operated under different conditions.

TYPICAL CHARACTERISTICS

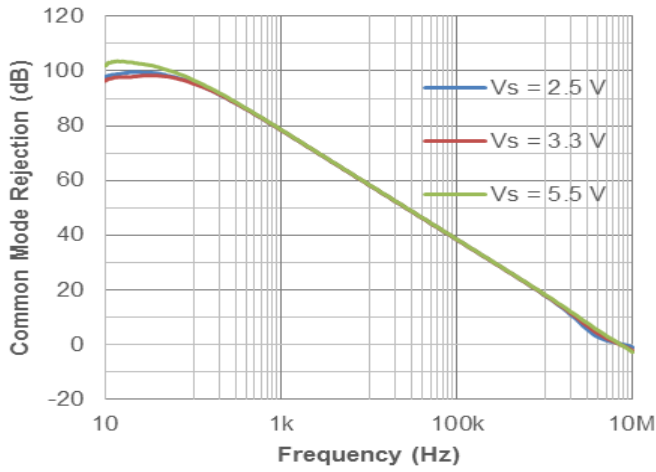

Figure 1. CMRR vs. Frequency

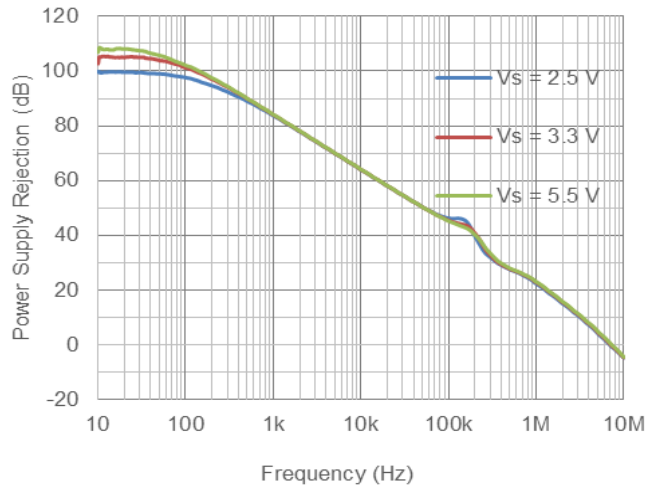

Figure 2. PSRR vs. Frequency

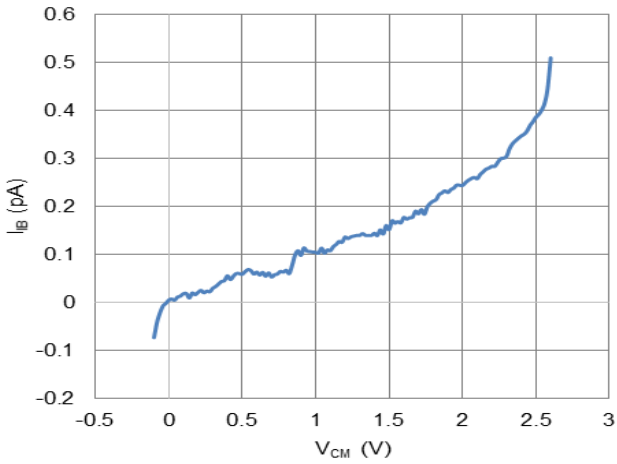

Figure 3. Input Bias Current vs. V_{CM} at $V_S = 2.5\text{ V}$

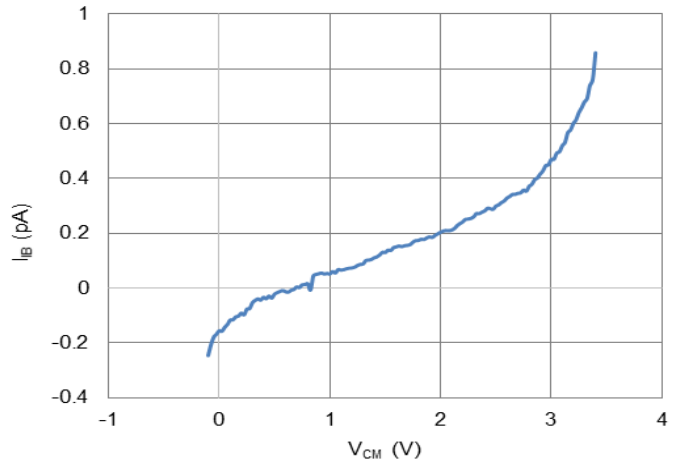

Figure 4. Input Bias Current vs. V_{CM} at $V_S = 3.3\text{ V}$

TYPICAL CHARACTERISTICS

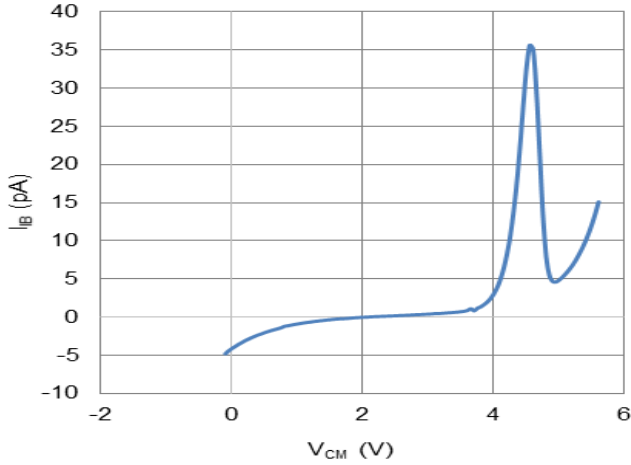

Figure 5. Input Bias Current vs. V_{CM} at $V_S = 5.5 V$

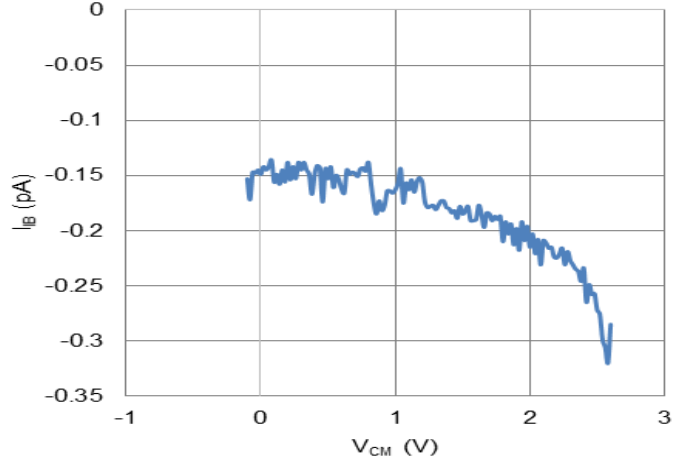

Figure 6. Input Offset Current vs. V_{CM} at $V_S = 2.5 V$

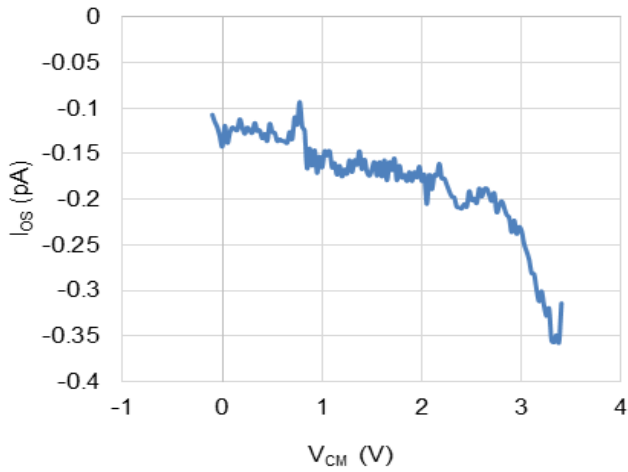

Figure 7. Input Offset Current vs. V_{CM} at $V_S = 3.3 V$

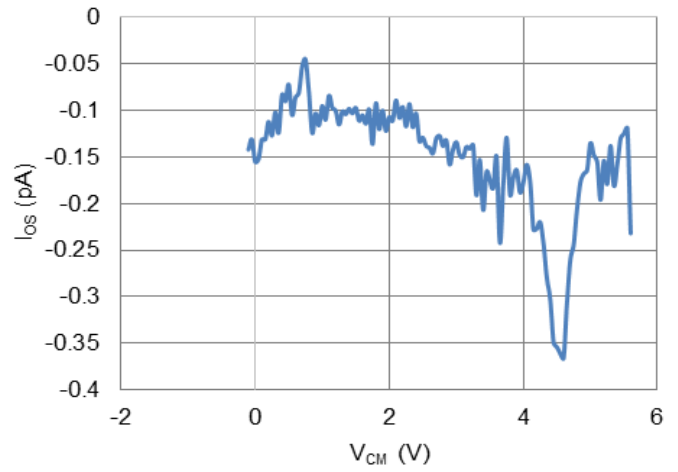

Figure 8. Input Offset Current vs. V_{CM} at $V_S = 5.5 V$

TYPICAL CHARACTERISTICS

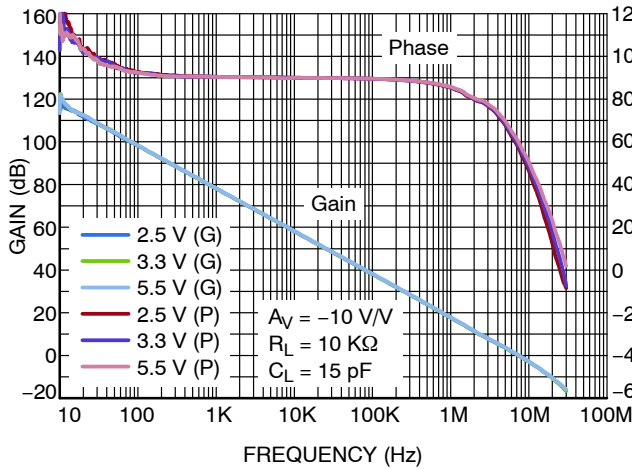

Figure 9. Open Loop Gain and Phase Margin vs. Frequency

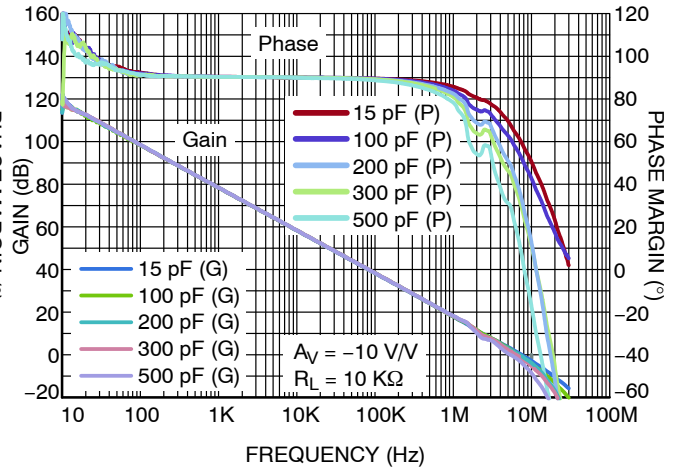

Figure 10. Open Loop Gain and Phase Margin vs. CL

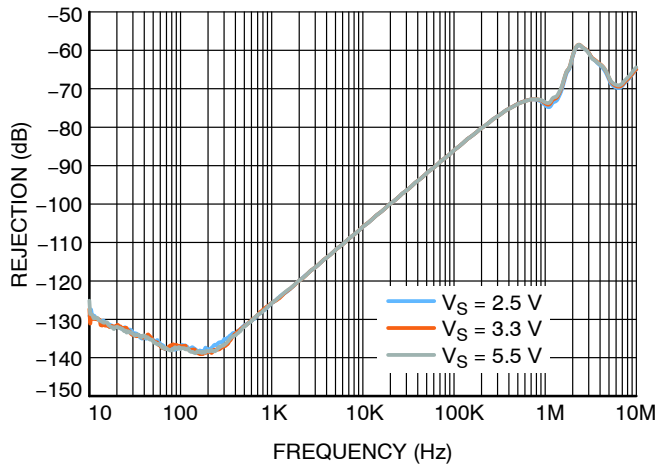

Figure 11. Channel Separation

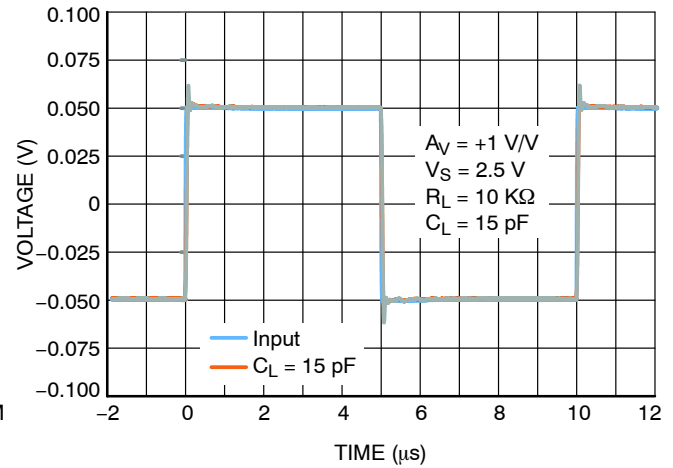

Figure 12. Non Inverting Small Signal Transient Response

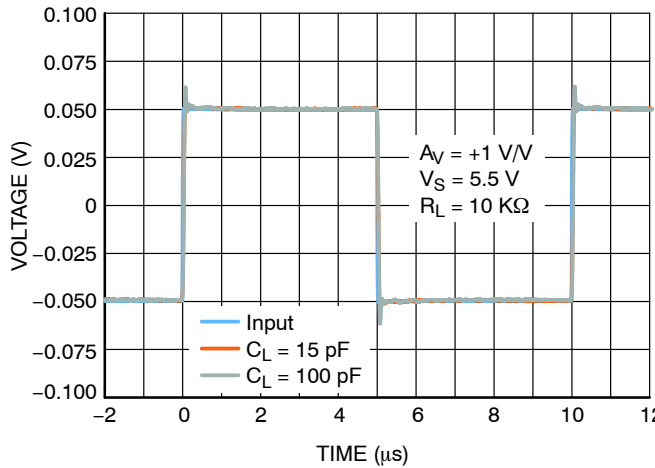

Figure 13. Non Inverting Small Signal Transient Response

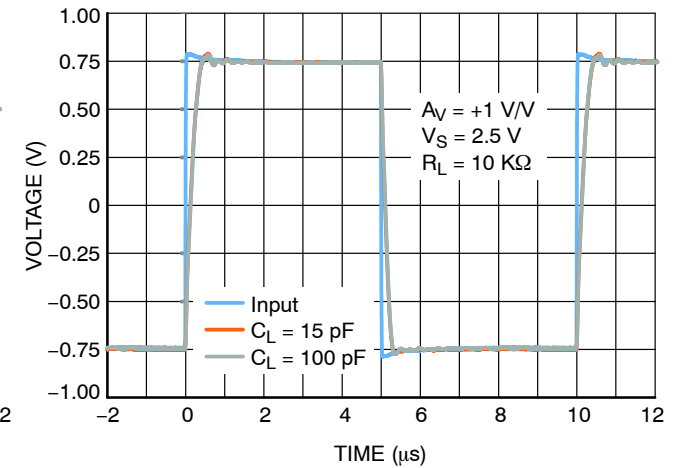

Figure 14. Non Inverting Large Signal Transient Response

TYPICAL CHARACTERISTICS

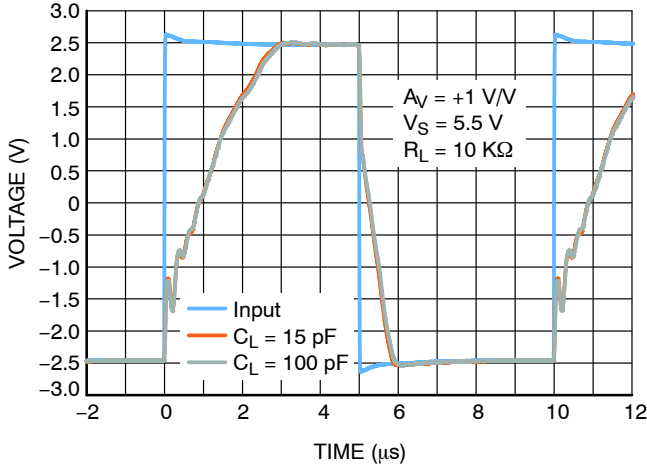

Figure 15. Non Inverting Large Signal Transient Response

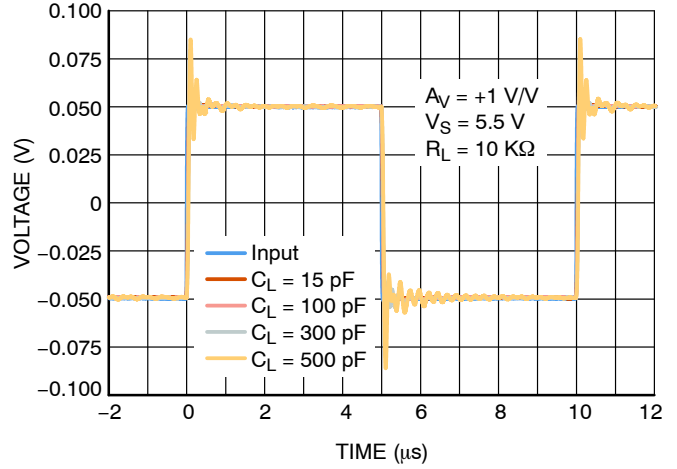

Figure 16. Non Inverting Large Signal Transient Response vs. C_{Load}

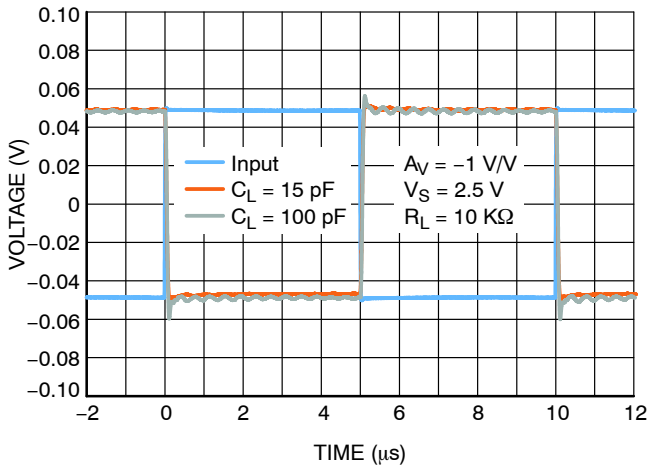

Figure 17. Inverting Small Signal Transient Response

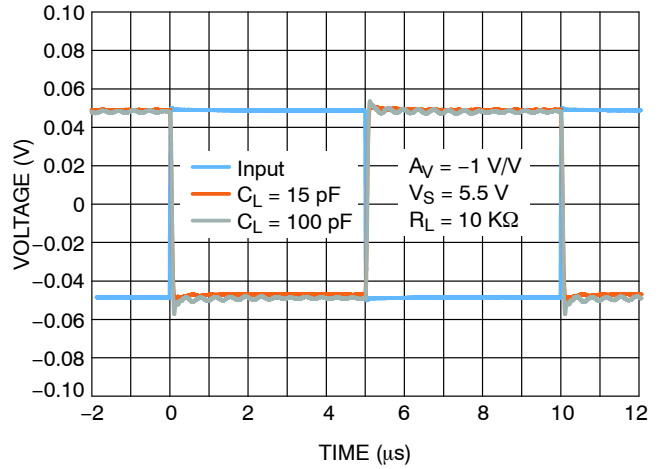

Figure 18. Inverting Small Signal Transient Response

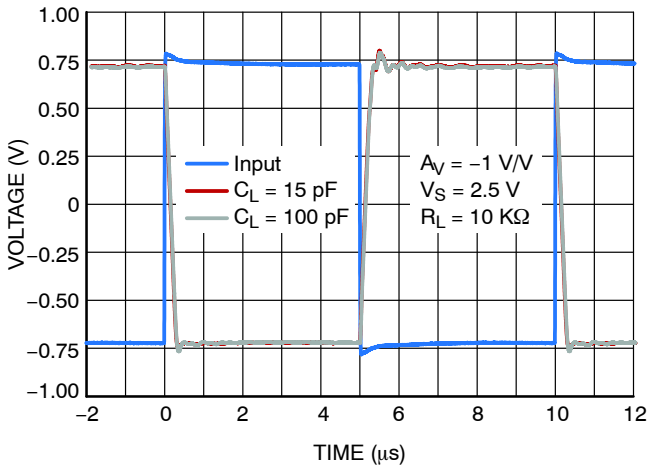

Figure 19. Inverting Large Signal Transient Response

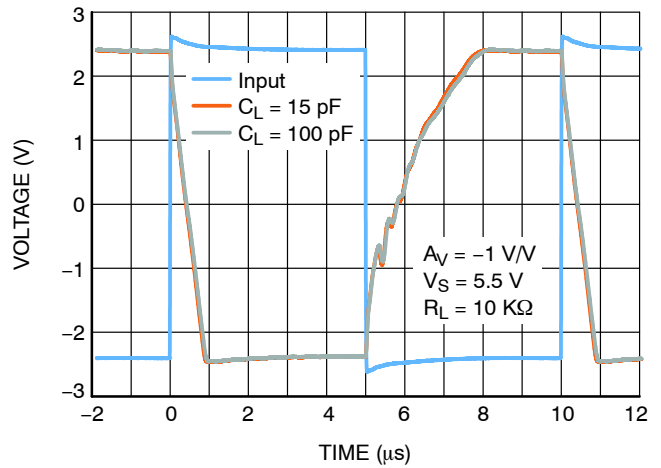

Figure 20. Inverting Large Signal Transient Response

TYPICAL CHARACTERISTICS

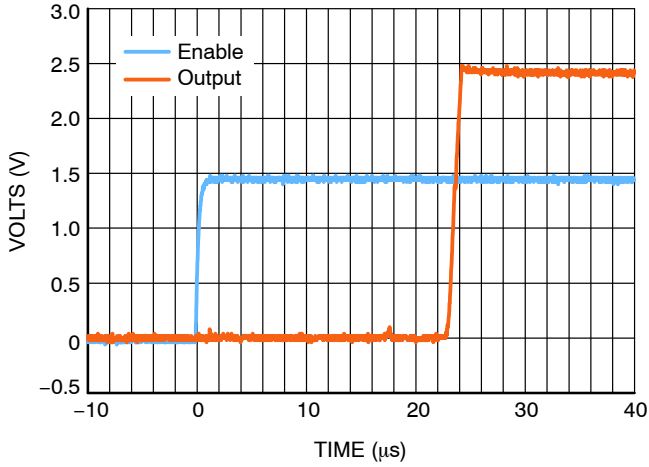

Figure 21. Enable Turn-On Time

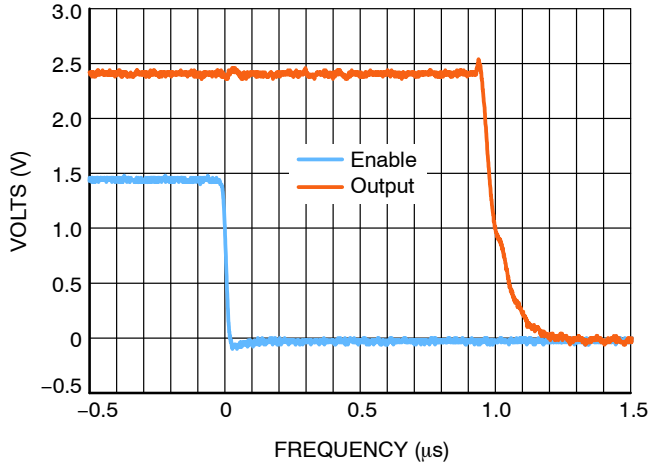

Figure 22. Disable Turn-Off Time

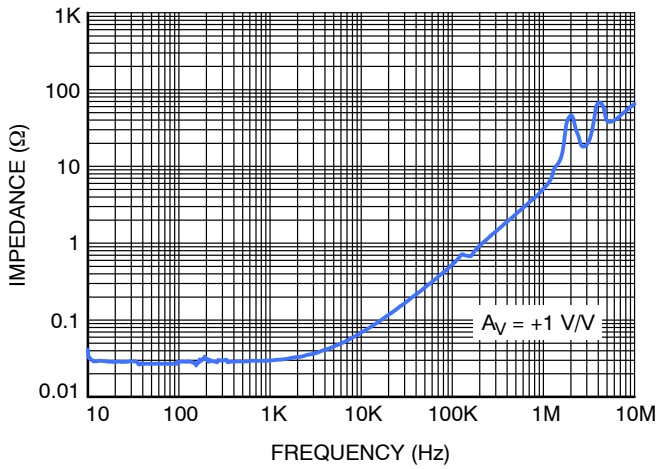

Figure 23. Closed Loop Output Impedance

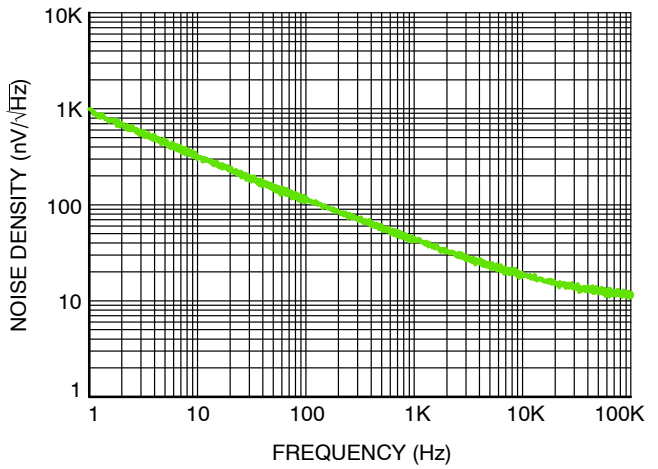

Figure 24. Voltage Noise Density vs. Frequency

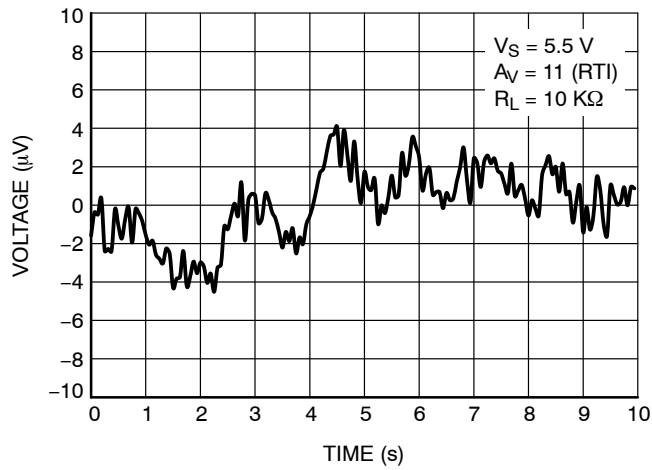

Figure 25. 0.1 Hz to 10 Hz Noise

NCS20282

DEVICE ORDERING INFORMATION

Device	Marking	Bump Type	Case Outline	Package	Shipping†
NCS20282FCTTAG	AAA	Sn Plate	567UW	WLCSP-9 (Pb-Free)	5000 / Tape & Reel
NCS20282FCSTAG* (In Development)	AAA	SAC 405	567YD	WLCSP-9 (Pb-Free)	5000 / Tape & Reel

†For information on tape and reel specifications, including part orientation and tape sizes, please refer to our Tape and Reel Packaging Specifications Brochure, BRD8011/D.

NCS20282

PACKAGE DIMENSIONS

WLCSP9, 1.02x1.02x0.33
CASE 567UW
ISSUE A

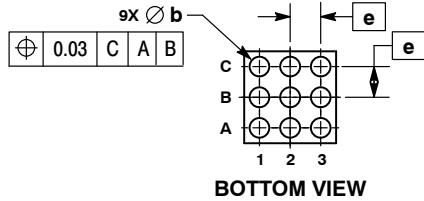
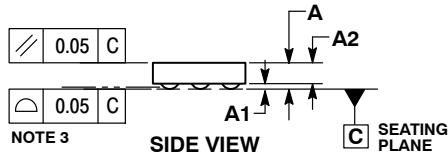
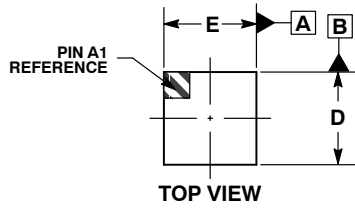

NOTES:

1. DIMENSIONING AND TOLERANCING PER ASME Y14.5M, 2009.
2. CONTROLLING DIMENSION: MILLIMETERS.
3. COPLANARITY APPLIES TO THE SPHERICAL CROWNS OF THE SOLDER BALLS.

DIM	MILLIMETERS		
	MIN	NOM	MAX
A	---	---	0.33
A1	0.04	0.06	0.08
A2	0.23 REF		
b	0.180	0.200	0.220
D	0.99	1.02	1.05
E	0.99	1.02	1.05
e	0.35 BSC		

RECOMMENDED SOLDERING FOOTPRINT*

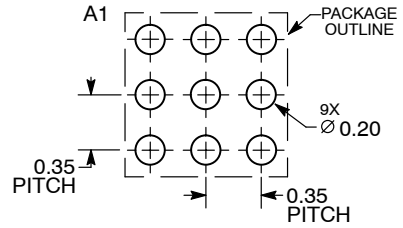

DIMENSIONS: MILLIMETERS

*For additional information on our Pb-Free strategy and soldering details, please download the ON Semiconductor Soldering and Mounting Techniques Reference Manual, SOLDERRM/D.

NCS20282

PACKAGE DIMENSIONS

WLCSP9, 1.02x1.02x0.441
CASE 567YD
ISSUE O

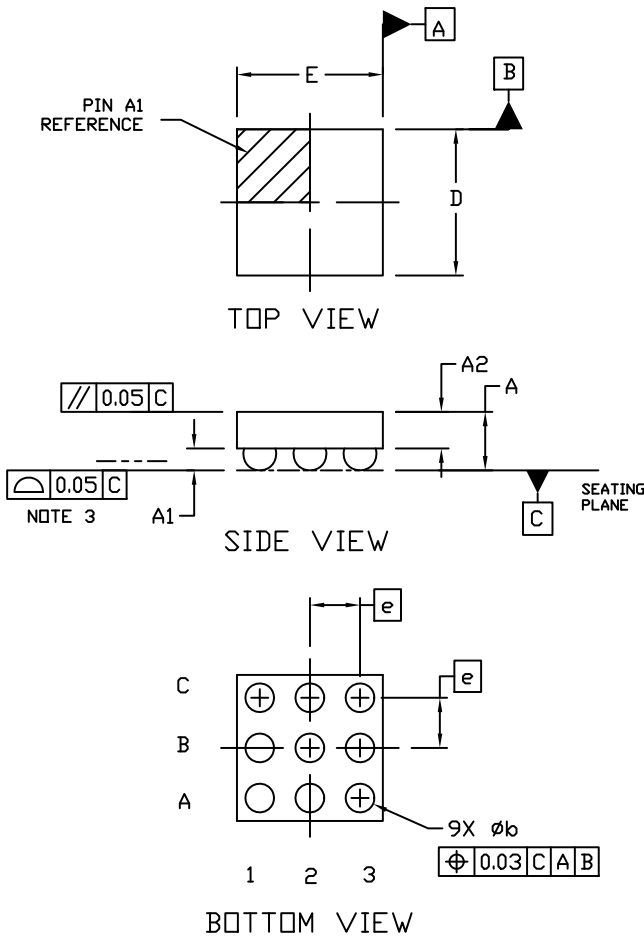

NOTES:

1. DIMENSIONING AND TOLERANCING PER ASME Y14.5M, 1994.
2. CONTROLLING DIMENSION: MILLIMETERS
3. COPLANARITY APPLIES TO THE SPHERICAL CROWNS OF THE SOLDER BALLS.

DIM	MILLIMETERS		
	MIN.	NOM.	MAX.
A	---	---	0.441
A1	0.133	0.153	0.173
A2	0.255 REF		
b	0.183	0.203	0.223
D	0.99	1.02	1.05
E	0.99	1.02	1.05
e	0.35 BSC		

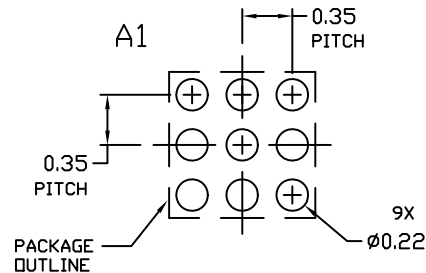

RECOMMENDED MOUNTING FOOTPRINT

- * For additional information on our Pb-Free strategy and soldering details, please download the ON Semiconductor Soldering and Mounting Techniques Reference Manual, SOLDERM/D.

ON Semiconductor and are trademarks of Semiconductor Components Industries, LLC dba ON Semiconductor or its subsidiaries in the United States and/or other countries. ON Semiconductor owns the rights to a number of patents, trademarks, copyrights, trade secrets, and other intellectual property. A listing of ON Semiconductor's product/patent coverage may be accessed at www.onsemi.com/site/pdf/Patent-Marking.pdf. ON Semiconductor reserves the right to make changes without further notice to any products herein. ON Semiconductor makes no warranty, representation or guarantee regarding the suitability of its products for any particular purpose, nor does ON Semiconductor assume any liability arising out of the application or use of any product or circuit, and specifically disclaims any and all liability, including without limitation special, consequential or incidental damages. Buyer is responsible for its products and applications using ON Semiconductor products, including compliance with all laws, regulations and safety requirements or standards, regardless of any support or applications information provided by ON Semiconductor. "Typical" parameters which may be provided in ON Semiconductor data sheets and/or specifications can and do vary in different applications and actual performance may vary over time. All operating parameters, including "Typicals" must be validated for each customer application by customer's technical experts. ON Semiconductor does not convey any license under its patent rights nor the rights of others. ON Semiconductor products are not designed, intended, or authorized for use as a critical component in life support systems or any FDA Class 3 medical devices or medical devices with a same or similar classification in a foreign jurisdiction or any devices intended for implantation in the human body. Should Buyer purchase or use ON Semiconductor products for any such unintended or unauthorized application, Buyer shall indemnify and hold ON Semiconductor and its officers, employees, subsidiaries, affiliates, and distributors harmless against all claims, costs, damages, and expenses, and reasonable attorney fees arising out of, directly or indirectly, any claim of personal injury or death associated with such unintended or unauthorized use, even if such claim alleges that ON Semiconductor was negligent regarding the design or manufacture of the part. ON Semiconductor is an Equal Opportunity/Affirmative Action Employer. This literature is subject to all applicable copyright laws and is not for resale in any manner.

PUBLICATION ORDERING INFORMATION

LITERATURE FULFILLMENT:
Email Requests to: orderlit@onsemi.com

TECHNICAL SUPPORT
North American Technical Support:
 Voice Mail: 1 800-282-9855 Toll Free USA/Canada
 Phone: 011 421 33 790 2910

Europe, Middle East and Africa Technical Support:
 Phone: 00421 33 790 2910
 For additional information, please contact your local Sales Representative