

# Precision Operational Amplifier, Low Offset, 10 MHz, Rail-to-Rail Input/Output

## NCS20166, NCV20166

The NCS20166 features rail-to-rail input and output, and 10 MHz bandwidth. This low quiescent current, low noise amplifier is trimmed to provide a low initial input offset voltage. This op amp operates over a supply range from 3.0 V to 5.5 V. All versions are specified for operation from  $-40^{\circ}\text{C}$  to  $+125^{\circ}\text{C}$ .

### Features

- Gain Bandwidth: 10 MHz Typical
- Offset Voltage: 550  $\mu\text{V}$  Max ( $V_S = 5\text{ V}$ )
- Supply Voltage: 3 V to 5.5 V
- Quiescent Current: 1.55 mA Max
- Voltage Noise Density: 10  $\text{nV}/\sqrt{\text{Hz}}$  Typical
- Rail-to-Rail Input and Output
- NCV Prefix for Automotive and Other Applications Requiring Unique Site and Control Change Requirements; AEC-Q100 Qualified and PPAP Capable
- These Devices are Pb-free, Halogen Free/BFR Free and are RoHS Compliant

### Typical Applications

- Current Sensing
- Current Sensing in Motor Control Circuits
- Current Monitor for Power Supplies
- Battery Powered Instrumentation
- Transducer or Sensor Interface
- Medical Instrumentation

### End Products

- Industrial
- Power Supplies
- Computers and Servers
- Automotive
- Medical Instrumentation



ON Semiconductor®

[www.onsemi.com](http://www.onsemi.com)



SC-74A (SOT23-5)  
CASE 318BQ

### MARKING DIAGRAM

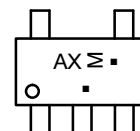

AX = Specific Device Code  
M = Date Code  
▪ = Pb-Free Package

(Note: Microdot may be in either location)

### PIN CONNECTIONS

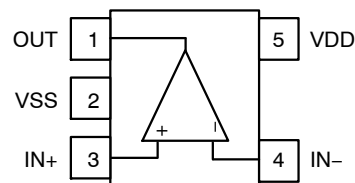

SC-74A (SOT23-5)  
SN2 Pinout

### ORDERING INFORMATION

See detailed ordering and shipping information on page 2 of this data sheet.

# NCS20166, NCV20166

## ORDERING INFORMATION

Device	Configuration	Marking	Package	Shipping†
--------	---------------	---------	---------	-----------

### INDUSTRIAL AND AUTOMOTIVE

NCS20166SN2T1G	Single	AX	SC-74A (SOT23-5)	3000 / Tape and Reel
NCV20166SN2T1G*		AX		

†For information on tape and reel specifications, including part orientation and tape sizes, please refer to our Tape and Reel Packaging Specifications Brochure, BRD8011/D.

\*NCV prefix for automotive and other applications requiring unique site and control change requirements; AEC-Q100 qualified and PPAP capable

\*\* Contact local sales office for more information

**Table 1. ABSOLUTE MAXIMUM RATINGS** Over operating free-air temperature, unless otherwise stated.

Parameter	Rating	Unit
Supply Voltage ( $V_{DD} - V_{SS}$ )	6	V

### INPUT AND OUTPUT PINS

Input Voltage (Note 1)	$V_{SS} - 0.3$ to $V_{DD} + 0.3$	V
Differential Input Voltage (Note 1)	$\pm V_S$	V
Input Current (Note 1)	$\pm 10$	mA
Output Short Circuit Current (Note 2)	Continuous	

### TEMPERATURE

Operating Temperature	-40 to +125	°C
Storage Temperature	-65 to +150	°C
Junction Temperature	+150	°C
Lead Temperature Soldering Reflow (SMD Styles Only), Pb-Free Versions	+260	°C

### ESD RATINGS (Note 3)

Human Body Model (HBM)	2000	V
Charged Device Model (CDM)	1000	V

### OTHER RATINGS

Latch-up Current (Note 4)	100	mA
Moisture Sensitivity Level (MSL)	1	
Continuous Total Power Dissipation	200	mW

Stresses exceeding those listed in the Maximum Ratings table may damage the device. If any of these limits are exceeded, device functionality should not be assumed, damage may occur and reliability may be affected.

1. Input terminals are diode clamped to the power supply rails. Input signals that can swing more than 0.3 V beyond the supply rails should be current limited to 10 mA or less
2. Short-circuit to ground up to  $T_A = 125^\circ\text{C}$ .
3. This device series incorporates ESD protection and is tested by the following methods:  
 ESD Human Body Model tested per JEDEC standard JS-001-2017 (AEC-Q100-002)  
 ESD Charged Device Model tested per JEDEC standard JS-002-2014 (AEC-Q100-011)
4. Latch-up Current tested per JEDEC standard JESD78E (AEC-Q100-004)

**Table 2. THERMAL INFORMATION** (Note 5)

Parameter	Symbol	Package	Value	Unit
Junction-to-Ambient	$\theta_{JA}$	SC-74A (SOT23-5)	198	°C/W

5. As mounted on an 80x80x1.5 mm FR4 PCB with 600 mm<sup>2</sup> and 2 oz (0.034 mm) thick copper heat spreader. Following JEDEC JESD/EIA 51.1, 51.2, 51.3 test guidelines

**Table 3. OPERATING CONDITIONS**

Parameter	Symbol	Min	Max	Units
Supply Voltage ( $V_{DD} - V_{SS}$ )	$V_S$	3	5.5	V
Specified Operating Temperature Range	$T_A$	-40	125	°C
Input Common Mode Voltage Range	$V_{ICMR}$	$V_{SS}$	$V_{DD}$	V

Functional operation above the stresses listed in the Recommended Operating Ranges is not implied. Extended exposure to stresses beyond the Recommended Operating Ranges limits may affect device reliability.

# NCS20166, NCV20166

**Table 4. ELECTRICAL CHARACTERISTICS**  $V_S = 3.0\text{ V to }5.5\text{ V}$

At  $T_A = +25^\circ\text{C}$ ,  $R_L = 10\text{ k}\Omega$ ,  $C_L = 15\text{ pF}$  connected to mid supply,  $V_{CM} = V_S/2$ , unless otherwise noted.

**Boldface** limits apply over the specified temperature range,  $T_A = -40^\circ\text{C}$  to  $125^\circ\text{C}$ , guaranteed by characterization and/or design.

Parameter	Symbol	Conditions	Min	Typ	Max	Units
<b>INPUT CHARACTERISTICS</b>						
Input Offset Voltage	$V_{OS}$	$V_S = 3\text{ to }5.5\text{ V}$ , $T_A = 25^\circ\text{C}$		$\pm 50$	$\pm 550$	$\mu\text{V}$
		$V_S = 3\text{ to }5.5\text{ V}$		$\pm 100$	<b><math>\pm 1050</math></b>	
Offset Voltage Drift	$\Delta V_{OS}/\Delta T$			$\pm 1$	$\pm 5$	$\mu\text{V}/^\circ\text{C}$
Input Bias Current (Note 6)	$I_{IB}$			$\pm 1$		$\text{pA}$
					<b><math>\pm 600</math></b>	$\text{pA}$
Input Offset Current (Note 6)	$I_{OS}$			$\pm 1$		$\text{pA}$
					<b><math>\pm 600</math></b>	$\text{pA}$
Common Mode Rejection Ratio @ $V_S = 5.5\text{ V}$	CMRR	$V_{CM} = V_{SS}\text{ to }V_{DD}$	<b>77</b>	92		dB
Common Mode Rejection Ratio @ $V_S = 3\text{ V}$			<b>70</b>	87		
Input Capacitance	$C_{IN}$	Differential		6		$\text{pF}$
		Common Mode		12		
<b>OUTPUT CHARACTERISTICS</b>						
Open Loop Voltage Gain	$A_{VOL}$	$V_O = V_{SS} + 0.05\text{ V to }V_{DD} - 0.05\text{ V}$		120		dB
Open Loop Output Impedance	$Z_{OUT\_OL}$			See Figure 29		$\Omega$
Output Voltage High, Referenced to Rail (Note 6)	$V_{OH}$	$I_L = 1\text{ mA}$			<b>30</b>	mV
		$I_L = 10\text{ mA}$			<b>120</b>	
Output Voltage Low, Referenced to Rail (Note 6)	$V_{OL}$	$I_L = 1\text{ mA}$			<b>30</b>	mV
		$I_L = 10\text{ mA}$			<b>120</b>	
Short Circuit Current	$I_{SC}$	Sinking Current		25		mA
		Sourcing Current		25		
<b>DYNAMIC PERFORMANCE</b>						
Gain Bandwidth Product	GBWP			10		MHz
Gain Margin	$A_M$	$V_S = 5.5\text{ V}$ , Load = $10\text{ k}\Omega \parallel 100\text{ pF}$		10		dB
Phase Margin	$\phi_M$	$V_S = 5.5\text{ V}$ , Load = $10\text{ k}\Omega \parallel 100\text{ pF}$		50		$^\circ$
Slew Rate	SR	1 V Step, Rising Edge, $V_S = 5.5\text{ V}$ $A_V = 1$ , Load = $10\text{ k}\Omega \parallel 100\text{ pF}$		6		$\text{V}/\mu\text{s}$
		1 V Step, Falling Edge, $V_S = 5.5\text{ V}$ $A_V = 1$ , Load = $10\text{ k}\Omega \parallel 100\text{ pF}$		4		
		1 V Step, Rising Edge, $V_S = 5.5\text{ V}$ $A_V = 1$ , Load = $10\text{ k}\Omega \parallel 60\text{ pF}$		6		
		1 V Step, Falling Edge, $V_S = 5.5\text{ V}$ $A_V = 1$ , Load = $10\text{ k}\Omega \parallel 60\text{ pF}$		4		
Settling Time	$t_S$	$0.1\% V_O = 2\text{ V step}$ , $A_V = -1$		0.5		$\mu\text{s}$
		$0.01\% V_O = 2\text{ V step}$ , $A_V = -1$		1		$\mu\text{s}$
Turn On Time	$t_{ON}$			3.5		$\mu\text{s}$
Overload Recovery Time	$t_{OR}$	$V_{IN} \leq 100\text{ mV Step}$ , $A_V = -100$		2		$\mu\text{s}$
Capacitive Load Drive	$C_L$			See Figure 30		$\text{pF}$

# NCS20166, NCV20166

**Table 4. ELECTRICAL CHARACTERISTICS**  $V_S = 3.0\text{ V to }5.5\text{ V}$

At  $T_A = +25^\circ\text{C}$ ,  $R_L = 10\text{ k}\Omega$ ,  $C_L = 15\text{ pF}$  connected to mid supply,  $V_{CM} = V_S/2$ , unless otherwise noted.

**Boldface** limits apply over the specified temperature range,  $T_A = -40^\circ\text{C to }125^\circ\text{C}$ , guaranteed by characterization and/or design.

Parameter	Symbol	Conditions	Min	Typ	Max	Units
<b>NOISE PERFORMANCE</b>						
Total Harmonic Distortion + Noise	THD+N	$V_S = 5.5\text{ V}$ , $f_{IN} = 1\text{ kHz}$ , $AV = 1$ , $V_{out} = 1\text{ V}_{rms}$		0.001		%
Voltage Noise Density	$e_N$	$V_S = 5.5\text{ V}$ , $f_{IN} = 1\text{ kHz}$		10		nV/ $\sqrt{\text{Hz}}$
Voltage Noise, Peak-to-Peak	$e_{pp}$	$V_S = 5.5\text{ V}$ , $f_{IN} = 0.1\text{ Hz to }10\text{ Hz}$		3		$\mu\text{V}_{pp}$
<b>POWER SUPPLY</b>						
Power Supply Rejection Ratio	PSRR	$V_S = 3\text{ V to }5.5\text{ V}$	<b>73</b>	89		dB
Quiescent Current	$I_Q$	No load		1	1.25	mA
					<b>1.55</b>	

Product parametric performance is indicated in the Electrical Characteristics for the listed test conditions, unless otherwise noted. Product performance may not be indicated by the Electrical Characteristics if operated under different conditions.

6. Performance guaranteed over the indicated operating temperature range by design and/or characterization.

TYPICAL CHARACTERISTICS

T<sub>A</sub> = 25°C, V<sub>S</sub> = 5.5 V, V<sub>CM</sub> = V<sub>S</sub>/2, unless otherwise noted.

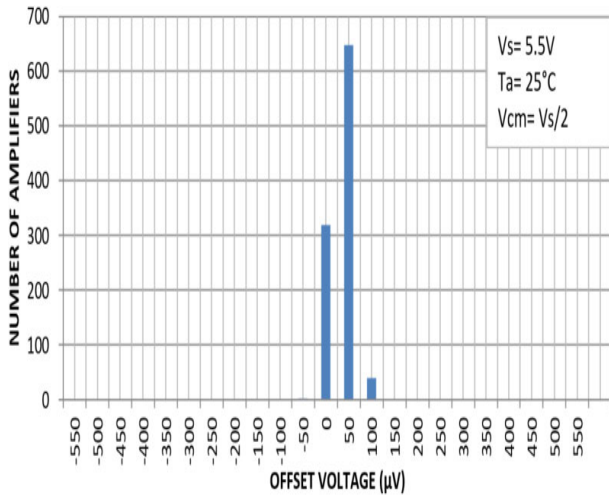

Figure 1. Input Offset Voltage Distribution, V<sub>S</sub> = 5.5 V, 25°C

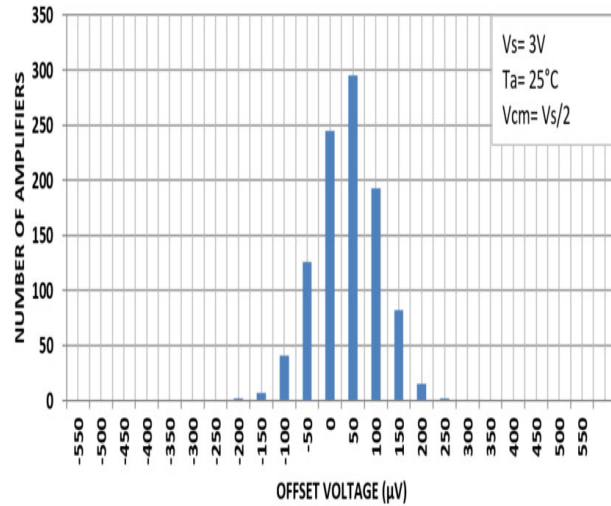

Figure 2. Input Offset Voltage Distribution, V<sub>S</sub> = 3 V, 25°C

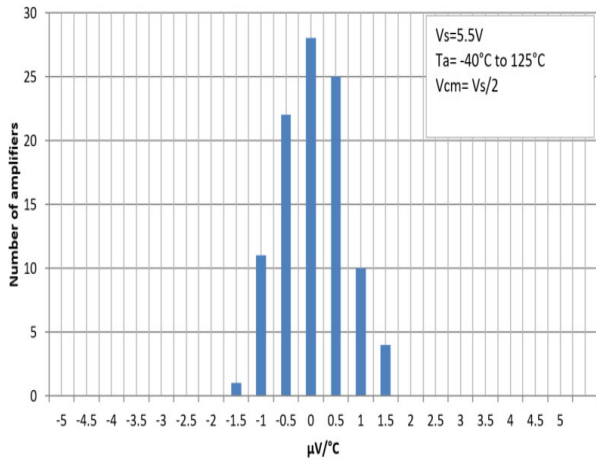

Figure 3. Input Offset Voltage vs. Temperature Distribution, V<sub>S</sub> = 5.5 V

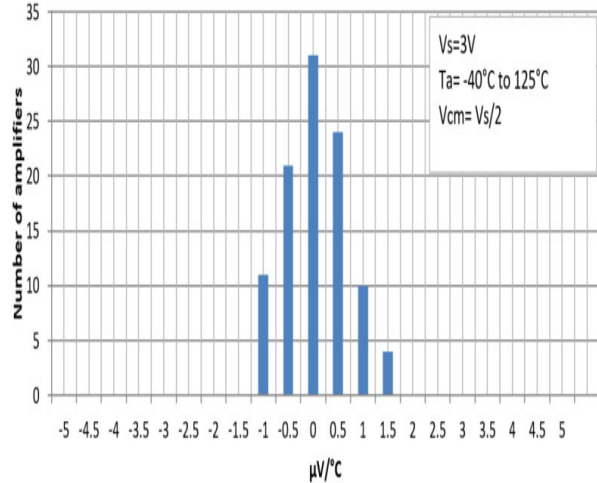

Figure 4. Input Offset Voltage vs. Temperature Distribution, V<sub>S</sub> = 3 V

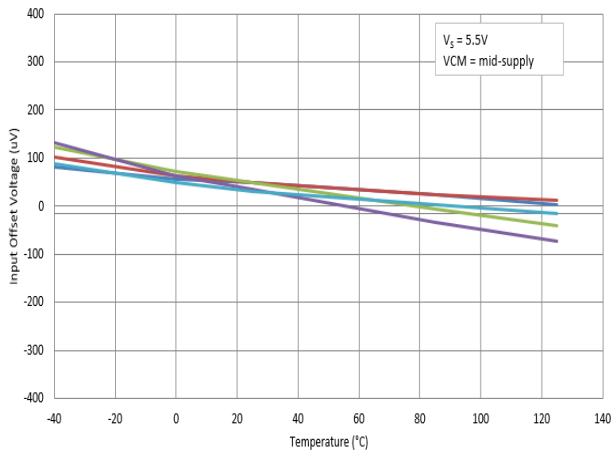

Figure 5. Input Offset Voltage vs. Temperature, V<sub>S</sub> = 5.5 V

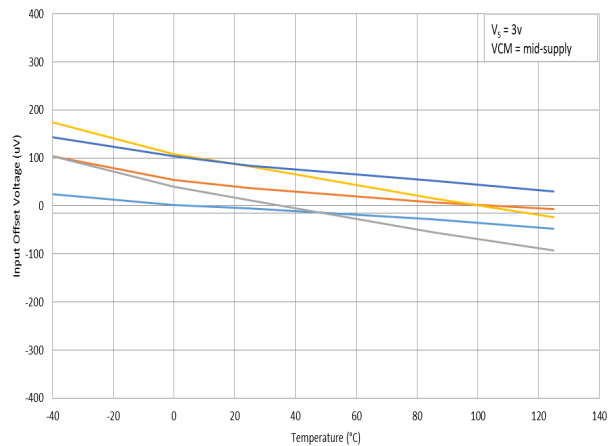

Figure 6. Input Offset Voltage vs. Temperature, V<sub>S</sub> = 3 V

# NCS20166, NCV20166

## TYPICAL CHARACTERISTICS

$T_A = 25^\circ\text{C}$ ,  $V_S = 5.5\text{ V}$ ,  $V_{CM} = V_S/2$ , unless otherwise noted.

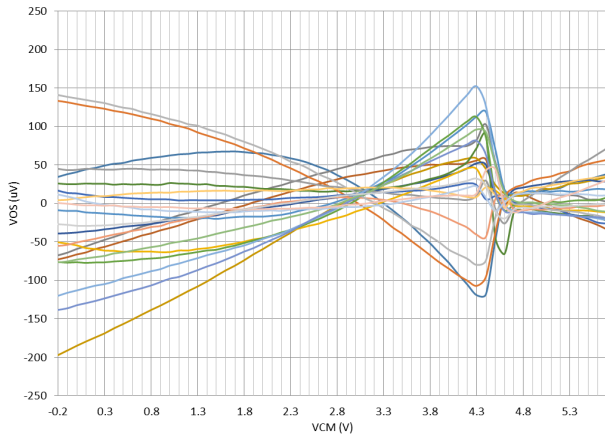

Figure 7. Input Offset Voltage vs. Input Common Mode Voltage,  $V_S = 5.5\text{ V}$

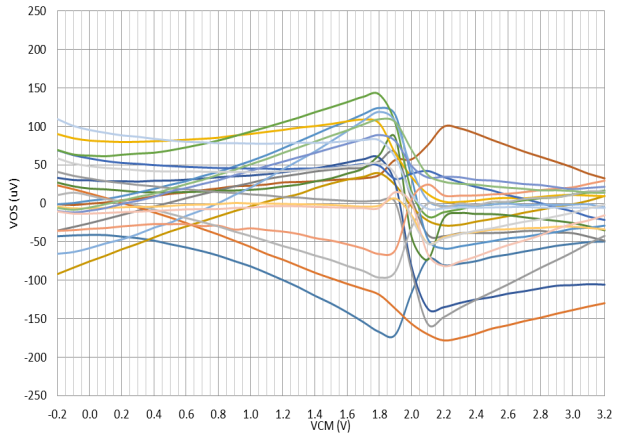

Figure 8. Input Offset Voltage vs. Input Common Mode Voltage,  $V_S = 3\text{ V}$

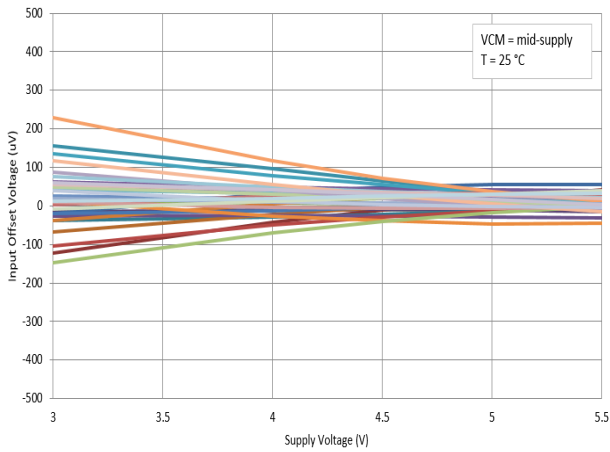

Figure 9. Input Offset Voltage vs. Supply Voltage,  $25^\circ\text{C}$

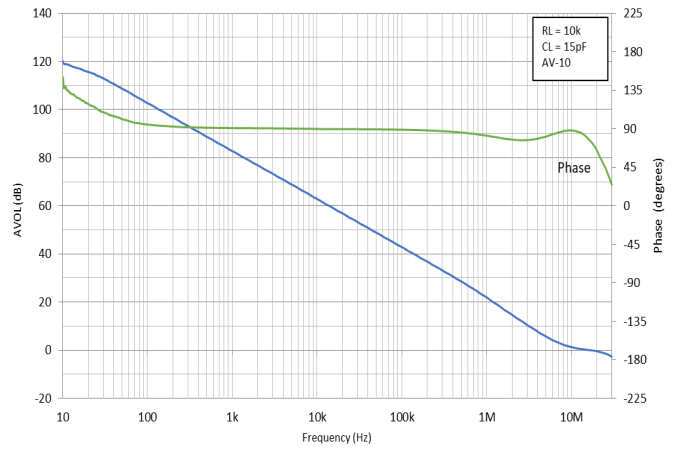

Figure 10. Gain and Phase vs. Frequency,  $V_S = 5.5\text{ V}$

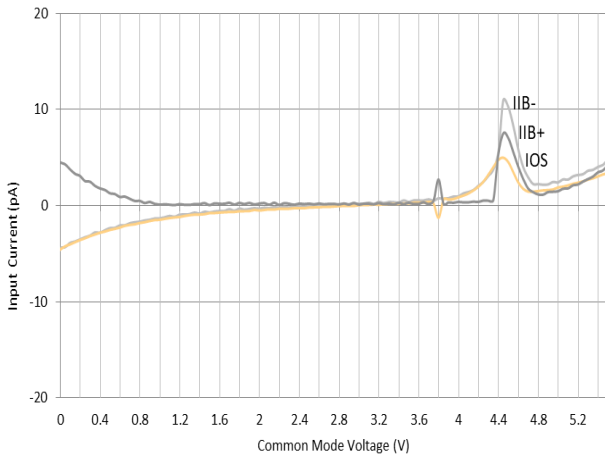

Figure 11. Input Bias and Offset Current vs. Common Mode Voltage,  $V_S = 5.5\text{ V}$

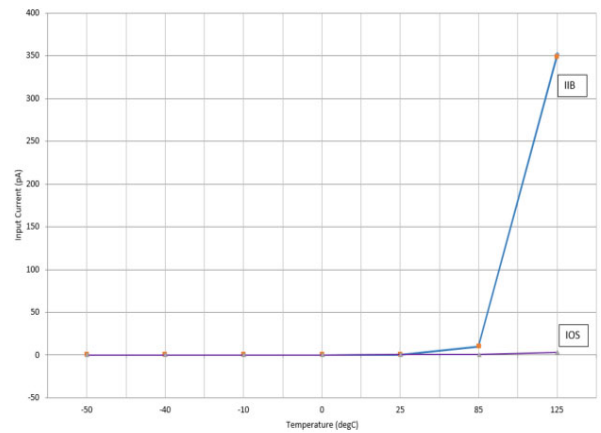
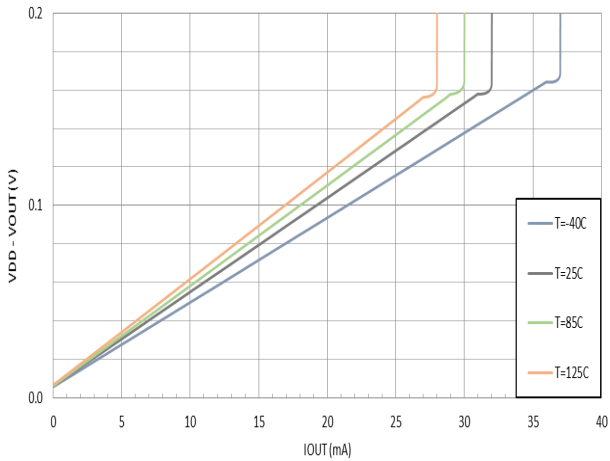

Figure 12. Input Bias Current and Input Offset Current vs. Temperature,  $V_S = 5.5\text{ V}$

# NCS20166, NCV20166

## TYPICAL CHARACTERISTICS

$T_A = 25^\circ\text{C}$ ,  $V_S = 5.5\text{ V}$ ,  $V_{CM} = V_S/2$ , unless otherwise noted.



**Figure 13.  $V_{OH}$  vs. Output Current vs. Temperature,  $V_S = 5.5\text{ V}$**

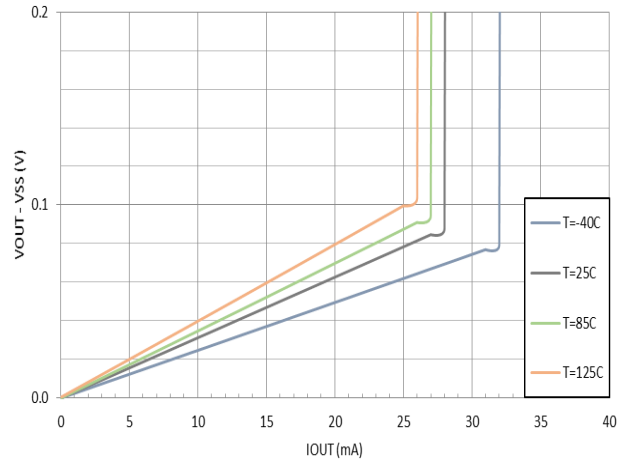

**Figure 14.  $V_{OL}$  vs. Output Current vs. Temperature,  $V_S = 5.5\text{ V}$**

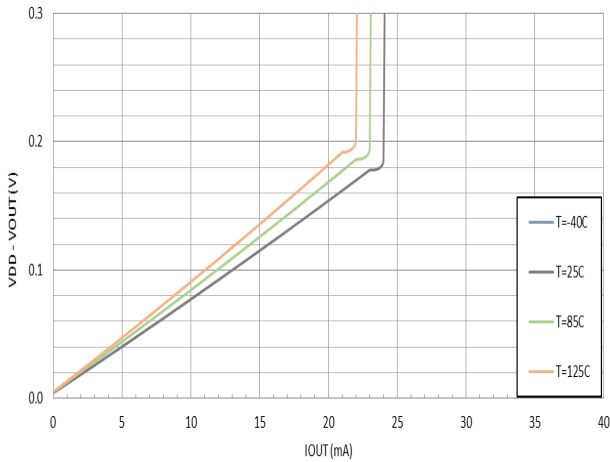

**Figure 15.  $V_{OH}$  vs. Output Current vs. Temperature,  $V_S = 3\text{ V}$**

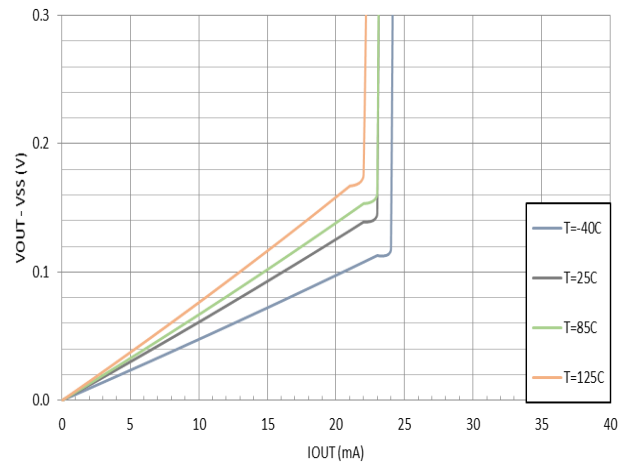

**Figure 16.  $V_{OL}$  vs. Output Current vs. Temperature,  $V_S = 3\text{ V}$**

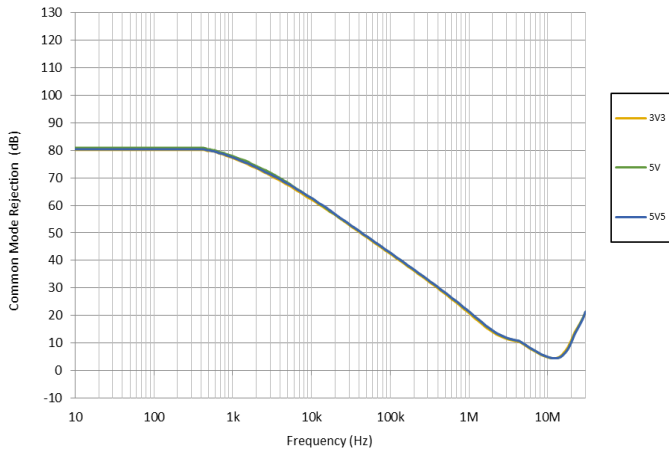

**Figure 17. Common Mode Rejection Ratio vs. Frequency**

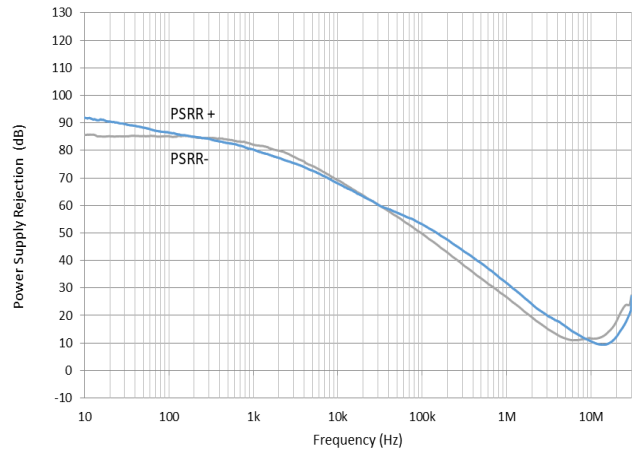
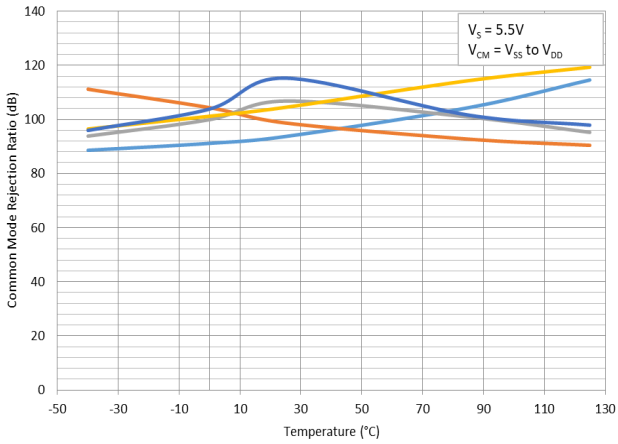

**Figure 18. Power Supply Rejection Ratio vs. Frequency,  $V_S = 5.5\text{ V}$**

# NCS20166, NCV20166

## TYPICAL CHARACTERISTICS

$T_A = 25^\circ\text{C}$ ,  $V_S = 5.5\text{ V}$ ,  $V_{CM} = V_S/2$ , unless otherwise noted.



**Figure 19. Common Mode Rejection Ratio vs. Temperature,  $V_S = 5.5\text{ V}$**

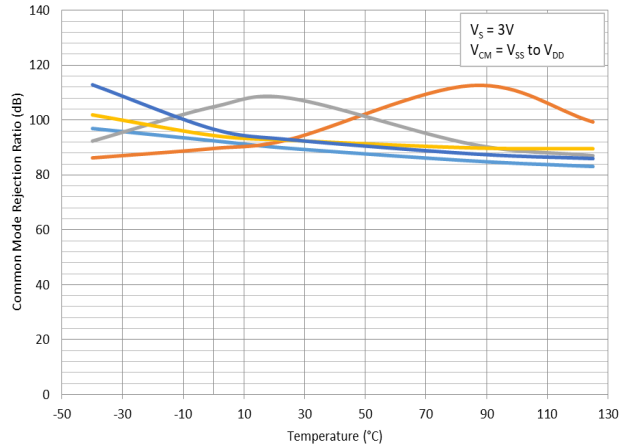

**Figure 20. Common Mode Rejection Ratio vs. Temperature,  $V_S = 3\text{ V}$**

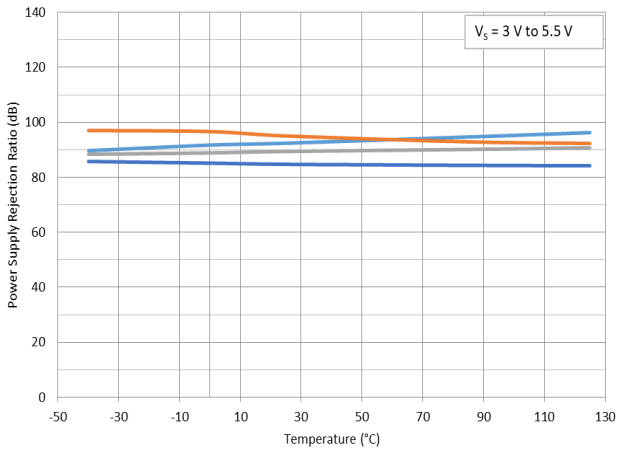

**Figure 21. Power Supply Rejection Ratio vs. Temperature**

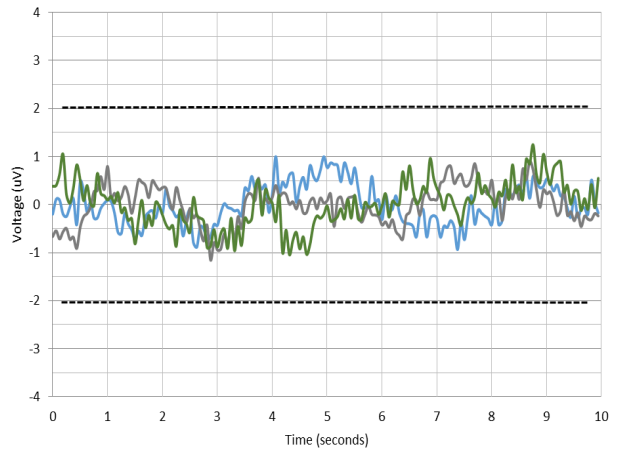

**Figure 22. 0.1 Hz 10 Hz Voltage Noise**

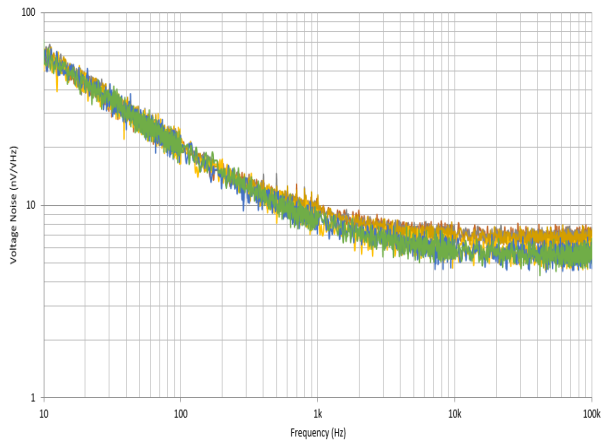

**Figure 23. Voltage Noise Density vs. Frequency**

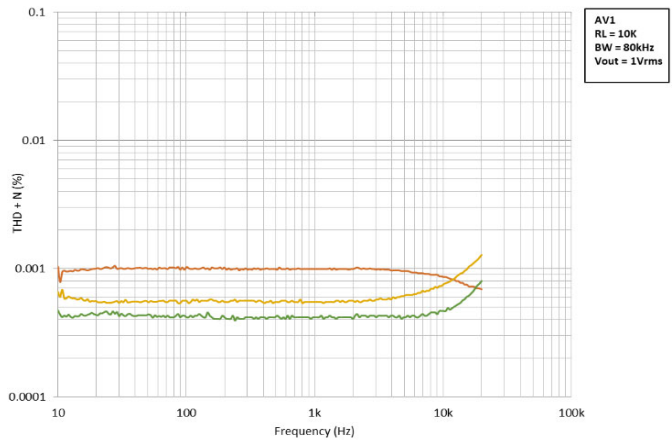

**Figure 24. THD + Noise vs. Frequency,  $V_S = 5.5\text{ V}$**



# NCS20166, NCV20166

## TYPICAL CHARACTERISTICS

$T_A = 25^\circ\text{C}$ ,  $V_S = 5.5\text{ V}$ ,  $V_{CM} = V_S/2$ , unless otherwise noted.

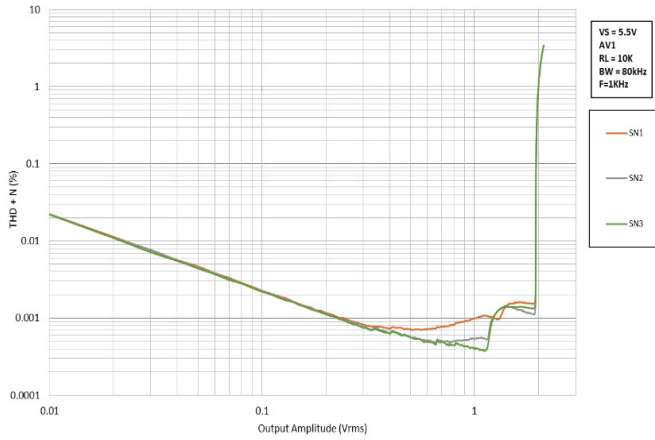

**Figure 25. THD + Noise vs. Output Amplitude at 1 KHz**

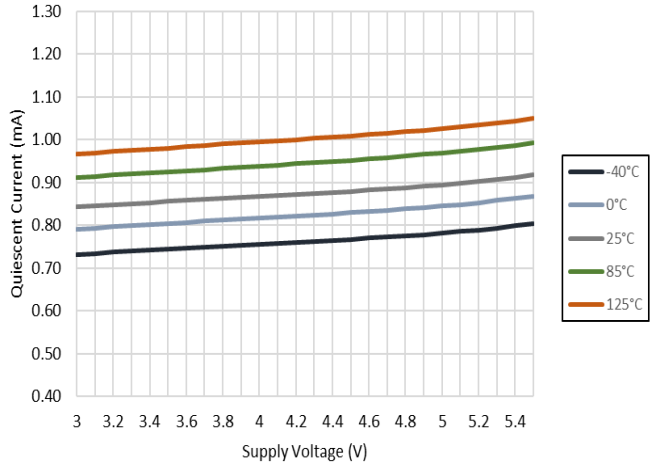

**Figure 26. Quiescent Current vs. Supply Voltage**

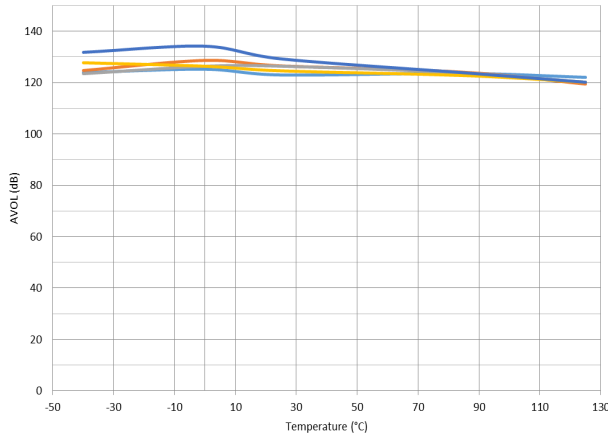

**Figure 27. Open Loop Gain vs. Temperature,  $V_S = 5.5\text{ V}$**

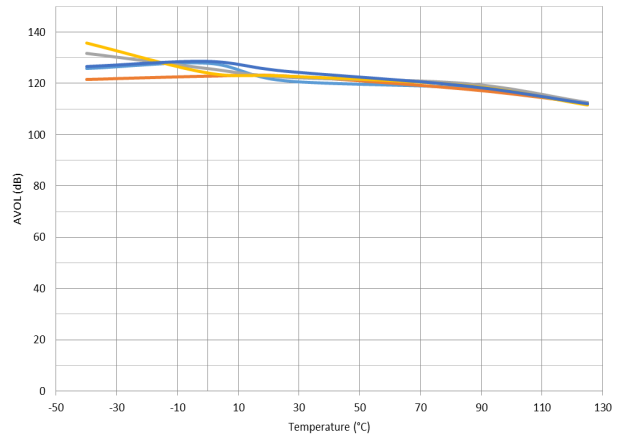

**Figure 28. Open Loop Gain vs. Temperature,  $V_S = 3\text{ V}$**

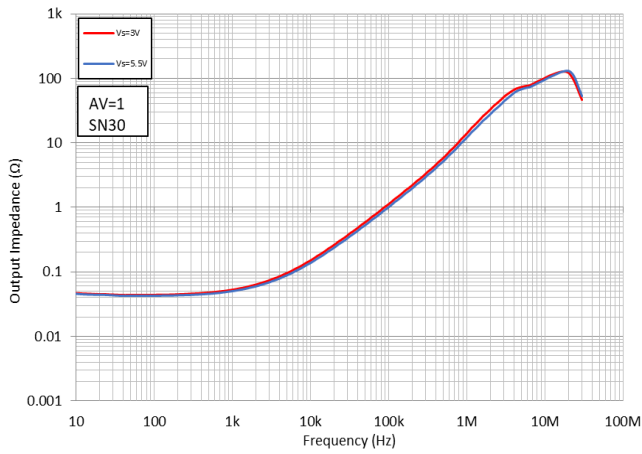

**Figure 29. Open Loop Output Impedance vs. Frequency**

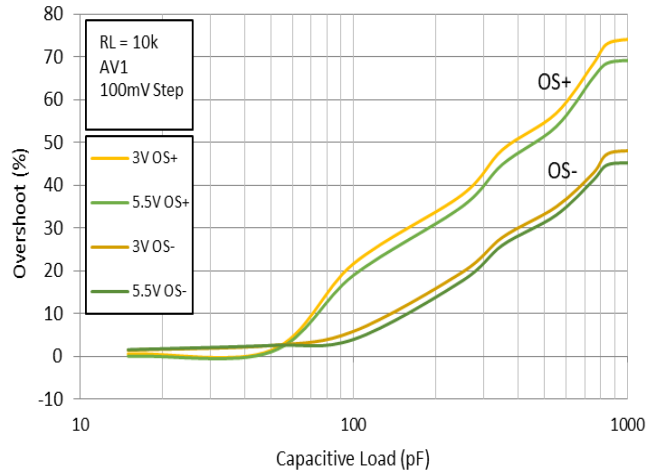

**Figure 30. Small Signal Overshoot vs. Capacitive Load**

TYPICAL CHARACTERISTICS

$T_A = 25^\circ\text{C}$ ,  $V_S = 5.5\text{ V}$ ,  $V_{CM} = V_S/2$ , unless otherwise noted.

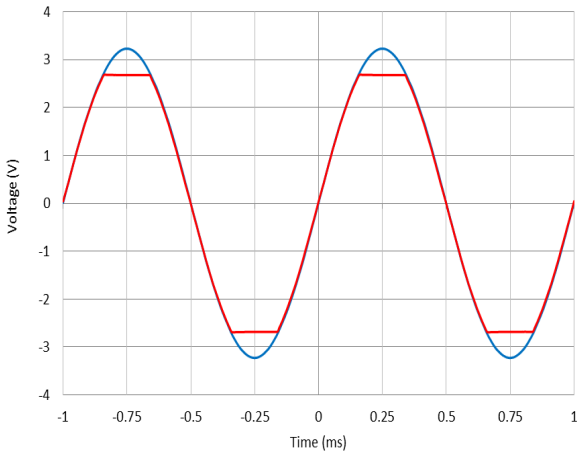

Figure 31. No Phase Reversal,  $V_S = 5.5\text{ V}$

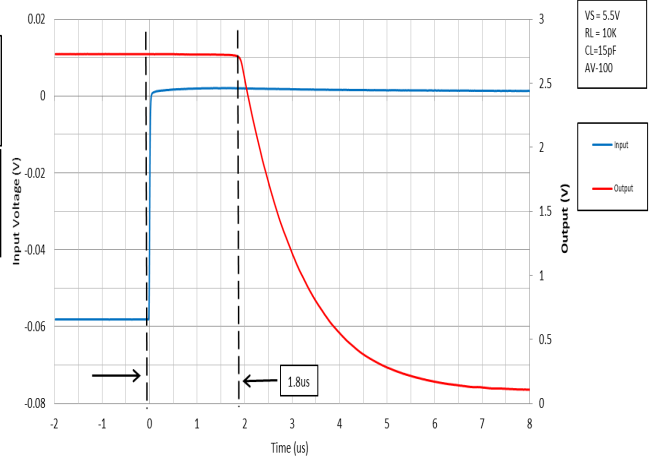

Figure 32. Positive Overload Recovery,  $V_S = 5.5\text{ V}$

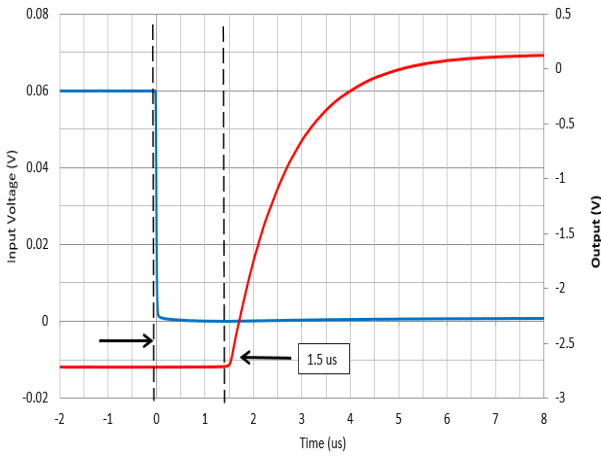

Figure 33. Negative Overload Recovery,  $V_S = 5.5\text{ V}$

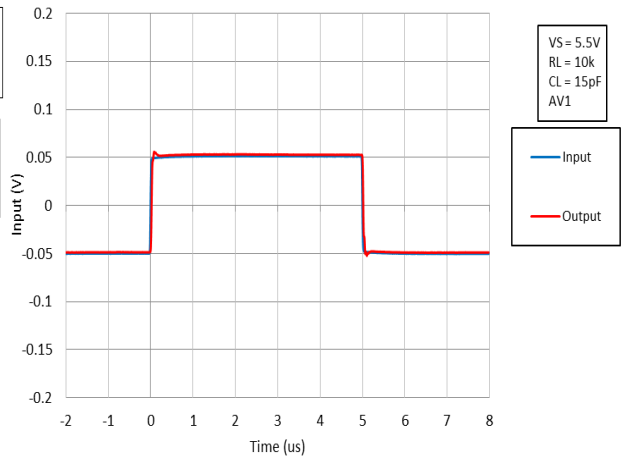

Figure 34. Small Signal Step Response, Non-Inverting,  $V_S = 5.5\text{ V}$

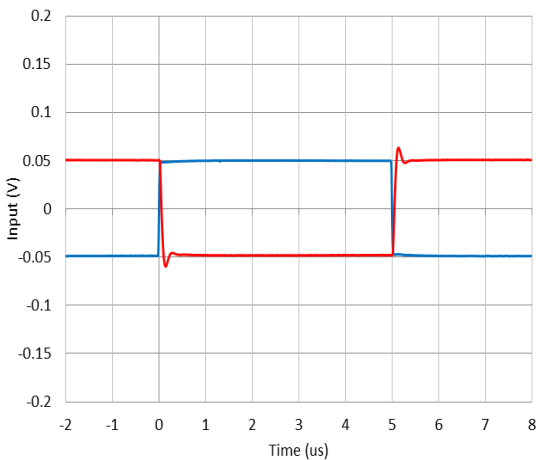

Figure 35. Small Signal Step Response, Inverting,  $V_S = 5.5\text{ V}$

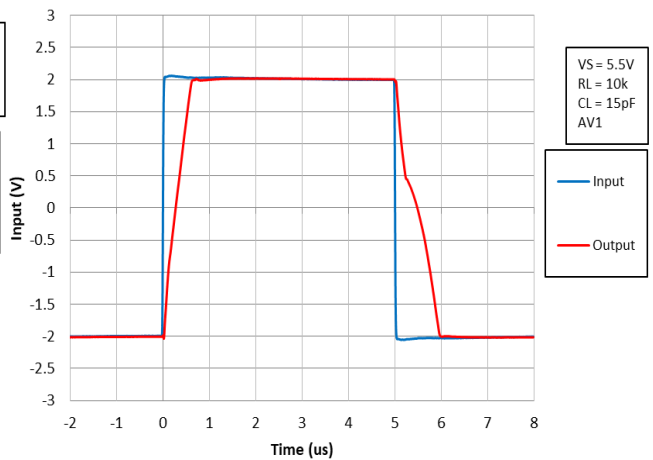
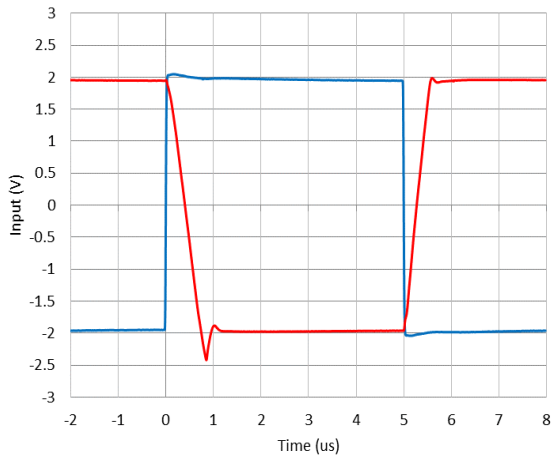

Figure 36. Large Signal Step Response, Non-Inverting,  $V_S = 5.5\text{ V}$

# NCS20166, NCV20166

## TYPICAL CHARACTERISTICS

$T_A = 25^\circ\text{C}$ ,  $V_S = 5.5\text{ V}$ ,  $V_{CM} = V_S/2$ , unless otherwise noted.



**Figure 37. Large Signal Step Response, Inverting,  $V_S = 5.5\text{ V}$**

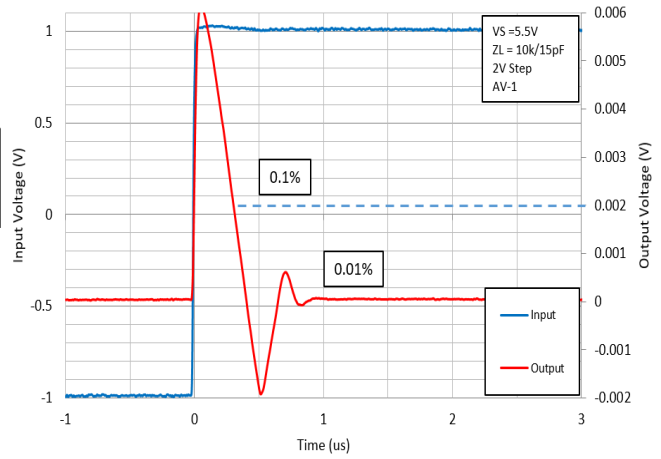

**Figure 38. Large Signal Settling Time (2 V Negative Step)**

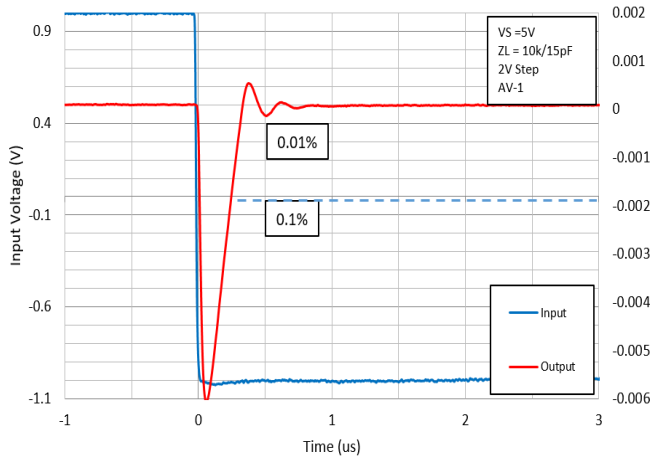

**Figure 39. Large Signal Settling Time (2 V Positive Step)**

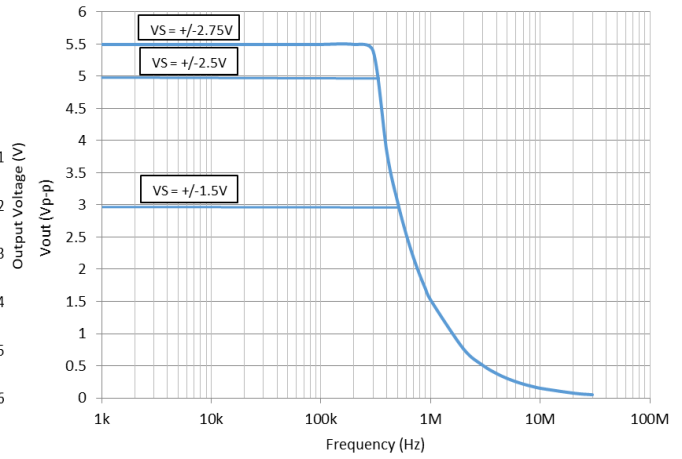

**Figure 40. Full Power Bandwidth**

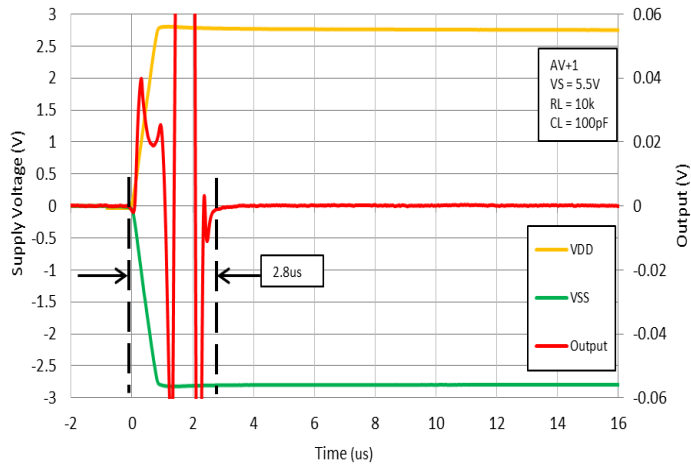

**Figure 41. Turn On Time,  $V_S = 5.5\text{ V}$**

APPLICATIONS INFORMATION

APPLICATION CIRCUITS

Low-Side Current Sensing

The goal of low-side current sensing is to detect over-current conditions or as a method of feedback control. A sense resistor is placed in series with the load to ground. Typically, the value of the sense resistor is less than 100 mΩ to reduce power loss across the resistor. The op amp

amplifies the voltage drop across the sense resistor with a gain set by external resistors R1, R2, R3, and R4 (where R1 = R2, R3 = R4). Precision resistors are required for high accuracy, and the gain is set to utilize the full scale of the ADC for the highest resolution.

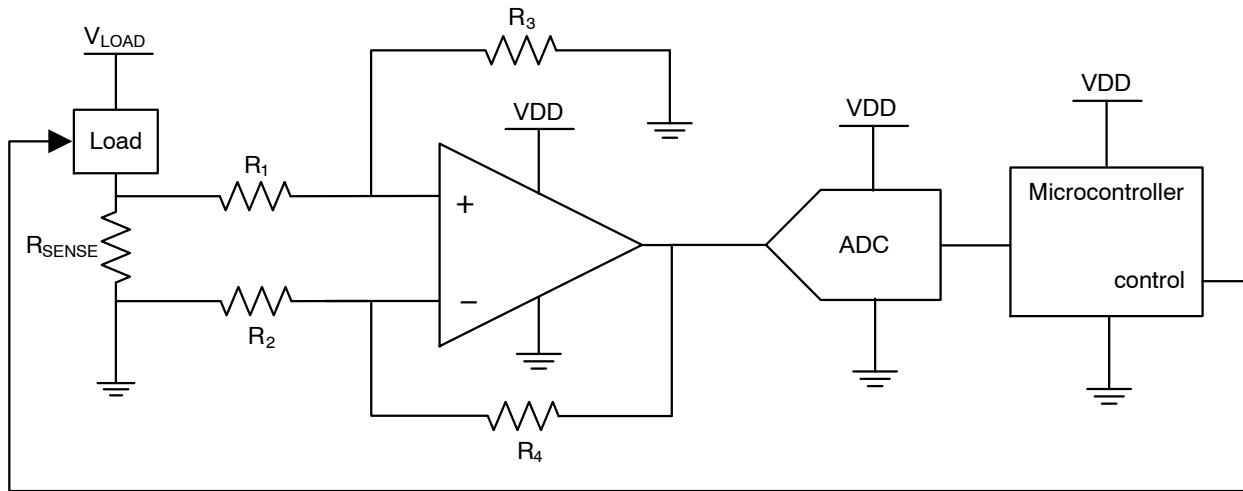

Figure 42. Low-Side Current Sensing

Differential Amplifier for Bridged Circuits

Sensors to measure strain, pressure, and temperature are often configured in a Wheatstone bridge circuit as shown in Figure 43. In the measurement, the voltage change that is produced is relatively small and needs to be amplified before going into an ADC. Precision amplifiers are recommended in these types of applications due to their high gain, low noise, and low offset voltage.

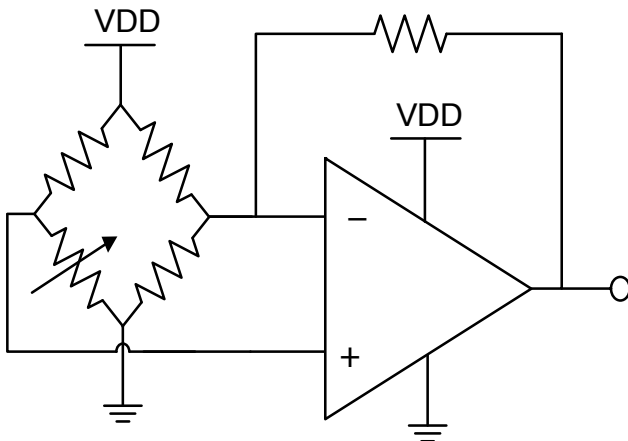

Figure 43. Bridge Circuit Amplification

GENERAL LAYOUT GUIDELINES

To ensure optimum device performance, it is important to follow good PCB design practices. Place 0.1 μF decoupling capacitors as close as possible to the supply pins. Keep traces short, utilize a ground plane, choose surface-mount components, and place components as close as possible to the device pins. These techniques will reduce susceptibility to electromagnetic interference (EMI). Thermoelectric effects can create an additional temperature dependent offset voltage at the input pins. To reduce these effects, use metals with low thermoelectric-coefficients and prevent temperature gradients from heat sources or cooling fans.

# MECHANICAL CASE OUTLINE

## PACKAGE DIMENSIONS

ON Semiconductor®

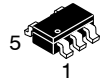

SCALE 2:1

### SC-74A CASE 318BQ ISSUE B

DATE 18 JAN 2018

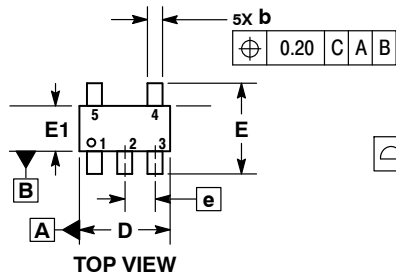

TOP VIEW

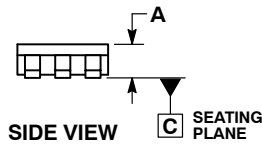

SIDE VIEW

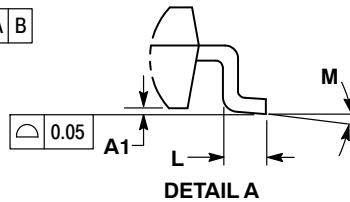

DETAIL A

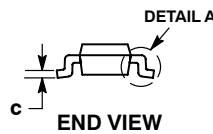

END VIEW

NOTES:

1. DIMENSIONING AND TOLERANCING PER ASME Y14.5M, 1994.
2. CONTROLLING DIMENSION: MILLIMETERS.
3. MAXIMUM LEAD THICKNESS INCLUDES LEAD FINISH THICKNESS. MINIMUM LEAD THICKNESS IS THE MINIMUM THICKNESS OF BASE MATERIAL.
4. DIMENSIONS A AND B DO NOT INCLUDE MOLD FLASH, PROTRUSIONS, OR GATE BURRS. MOLD FLASH, PROTRUSIONS, OR GATE BURRS SHALL NOT EXCEED 0.15 PER SIDE.

DIM	MILLIMETERS	
	MIN	MAX
A	0.90	1.10
A1	0.01	0.10
b	0.25	0.50
c	0.10	0.26
D	2.85	3.15
E	2.50	3.00
E1	1.35	1.65
e	0.95 BSC	
L	0.20	0.60
M	0°	10°

#### RECOMMENDED SOLDERING FOOTPRINT\*

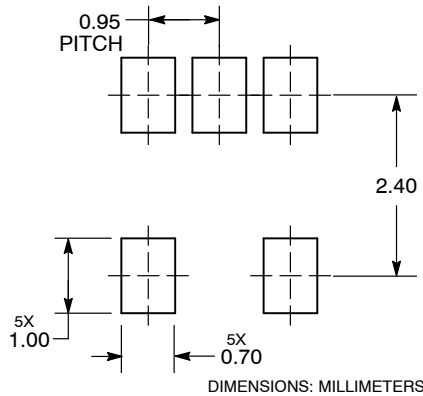

#### GENERIC MARKING DIAGRAM\*

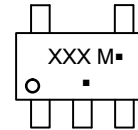

- XXX = Specific Device Code
- M = Date Code
- = Pb-Free Package

(Note: Microdot may be in either location)

\*This information is generic. Please refer to device data sheet for actual part marking. Pb-Free indicator, "G" or microdot "▪", may or may not be present. Some products may not follow the Generic Marking.

\*For additional information on our Pb-Free strategy and soldering details, please download the ON Semiconductor Soldering and Mounting Techniques Reference Manual, SOLDERRM/D.

<b>DOCUMENT NUMBER:</b>	<b>98AON66279G</b>	Electronic versions are uncontrolled except when accessed directly from the Document Repository. Printed versions are uncontrolled except when stamped "CONTROLLED COPY" in red.
<b>DESCRIPTION:</b>	<b>SC-74A</b>	<b>PAGE 1 OF 1</b>

ON Semiconductor and are trademarks of Semiconductor Components Industries, LLC dba ON Semiconductor or its subsidiaries in the United States and/or other countries. ON Semiconductor reserves the right to make changes without further notice to any products herein. ON Semiconductor makes no warranty, representation or guarantee regarding the suitability of its products for any particular purpose, nor does ON Semiconductor assume any liability arising out of the application or use of any product or circuit, and specifically disclaims any and all liability, including without limitation special, consequential or incidental damages. ON Semiconductor does not convey any license under its patent rights nor the rights of others.

**onsemi**, **Onsemi**, and other names, marks, and brands are registered and/or common law trademarks of Semiconductor Components Industries, LLC dba "**onsemi**" or its affiliates and/or subsidiaries in the United States and/or other countries. **onsemi** owns the rights to a number of patents, trademarks, copyrights, trade secrets, and other intellectual property. A listing of **onsemi**'s product/patent coverage may be accessed at [www.onsemi.com/site/pdf/Patent-Marking.pdf](http://www.onsemi.com/site/pdf/Patent-Marking.pdf). **onsemi** reserves the right to make changes at any time to any products or information herein, without notice. The information herein is provided "as-is" and **onsemi** makes no warranty, representation or guarantee regarding the accuracy of the information, product features, availability, functionality, or suitability of its products for any particular purpose, nor does **onsemi** assume any liability arising out of the application or use of any product or circuit, and specifically disclaims any and all liability, including without limitation special, consequential or incidental damages. Buyer is responsible for its products and applications using **onsemi** products, including compliance with all laws, regulations and safety requirements or standards, regardless of any support or applications information provided by **onsemi**. "Typical" parameters which may be provided in **onsemi** data sheets and/or specifications can and do vary in different applications and actual performance may vary over time. All operating parameters, including "Typicals" must be validated for each customer application by customer's technical experts. **onsemi** does not convey any license under any of its intellectual property rights nor the rights of others. **onsemi** products are not designed, intended, or authorized for use as a critical component in life support systems or any FDA Class 3 medical devices or medical devices with a same or similar classification in a foreign jurisdiction or any devices intended for implantation in the human body. Should Buyer purchase or use **onsemi** products for any such unintended or unauthorized application, Buyer shall indemnify and hold **onsemi** and its officers, employees, subsidiaries, affiliates, and distributors harmless against all claims, costs, damages, and expenses, and reasonable attorney fees arising out of, directly or indirectly, any claim of personal injury or death associated with such unintended or unauthorized use, even if such claim alleges that **onsemi** was negligent regarding the design or manufacture of the part. **onsemi** is an Equal Opportunity/Affirmative Action Employer. This literature is subject to all applicable copyright laws and is not for resale in any manner.

## PUBLICATION ORDERING INFORMATION

### LITERATURE FULFILLMENT:

Email Requests to: [orderlit@onsemi.com](mailto:orderlit@onsemi.com)

**onsemi Website:** [www.onsemi.com](http://www.onsemi.com)

### TECHNICAL SUPPORT

**North American Technical Support:**

Voice Mail: 1 800-282-9855 Toll Free USA/Canada

Phone: 011 421 33 790 2910

**Europe, Middle East and Africa Technical Support:**

Phone: 00421 33 790 2910

For additional information, please contact your local Sales Representative