

OPAx392 Precision, Low-Offset-Voltage, Low-Noise, Low-Input-Bias-Current, Rail-to-Rail I/O, e-trim™ Operational Amplifiers

1 Features

- Low offset voltage: $\pm 10 \mu\text{V}$ (maximum)
- Low-drift: $\pm 0.18 \mu\text{V}/^\circ\text{C}$
- Low input bias current: 10 fA
- Low noise: $4.4 \text{ nV}/\sqrt{\text{Hz}}$ at 10 kHz
- Low 1/f noise: $2 \mu\text{V}_{\text{PP}}$ (0.1 Hz to 10 Hz)
- Low supply voltage operation: 1.7 V to 5.5 V
- Low quiescent current: 1.22 mA
- Fast settling: $0.75 \mu\text{s}$ (1 V to 0.1%)
- Fast slew rate: 4.5 V/ μs
- High output current: +65/–55-mA short circuit
- Gain bandwidth: 13 MHz
- Rail-to-rail input and output
- Specified temperature range: -40°C to $+125^\circ\text{C}$
- EMI and RFI filtered inputs

2 Applications

- [Multiparameter patient monitor](#)
- [Electrocardiogram \(ECG\)](#)
- [Chemistry and gas analyzer](#)
- [Optical module](#)
- [Analog input module](#)
- [Process analytics \(pH, gas, concentration, force and humidity\)](#)
- [Gas detector](#)
- [Analog security camera](#)
- [Merchant DC/DC](#)
- [Pulse oximeter](#)
- [Inter-DC interconnect \(long-haul, submarine\)](#)
- [Data acquisition \(DAQ\)](#)

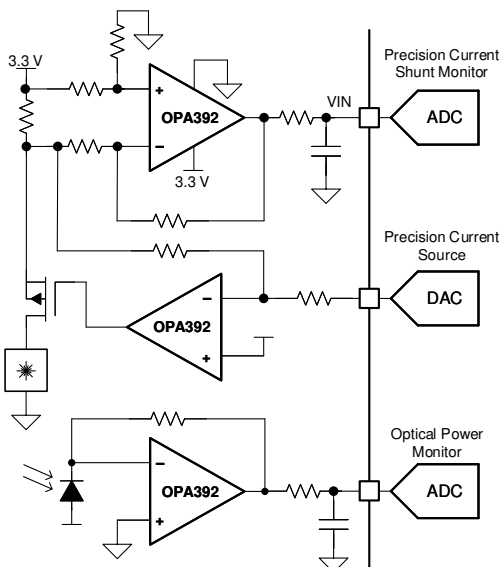

OPAx392 Applications in Optical Modules

3 Description

The OPAx392 family of operational amplifiers (OPA392, OPA2392, and OPA4392) features ultra-low offset, offset drift, and input bias current with rail-to-rail input and output operation. In addition to precision dc accuracy, the ac performance is optimized for low noise and fast-settling transient response. These features make the OPAx392 an excellent choice for driving high-precision analog-to-digital converters (ADCs) or buffering the output of high-resolution, digital-to-analog converters (DACs).

The OPAx392 feature TI's e-trim™ operational amplifier technology to achieve ultra-low offset voltage and offset voltage drift without any input chopping or auto-zero techniques. This technique enables ultra-low input bias current for sensor inputs or photodiode current-to-voltage measurements, creating high-performance transimpedance stages for optical modules or medical instrumentation.

Device Information

PART NUMBER	CHANNELS	PACKAGE ⁽¹⁾
OPA392	Single	DBV (SOT-23, 5)
	Single	DCK (SC70, 5) ⁽³⁾
	Single	YBJ (DSBGA, 6) ⁽³⁾
OPA2392	Dual	D (SOIC, 8) ⁽³⁾
	Dual	DGK (VSSOP, 8) ⁽³⁾
	Dual	YBJ (DSBGA, 9)
OPA4392 ⁽²⁾	Quad	PW (TSSOP, 14) ⁽³⁾
	Quad	RTE (WQFN, 16) ⁽³⁾

- (1) For all available packages, see the package option addendum at the end of the data sheet.
- (2) Device is preview information (not Production Data).
- (3) Package is preview information (not Production Data).

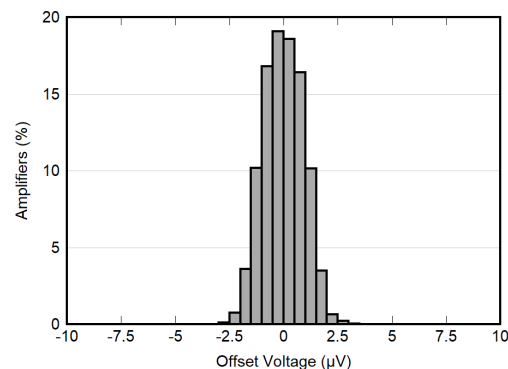

OPAx392 Input Offset Voltage Distribution



Table of Contents

1 Features	1	8.3 Feature Description.....	18
2 Applications	1	8.4 Device Functional Modes.....	18
3 Description	1	9 Application and Implementation	19
4 Revision History	2	9.1 Application Information.....	19
5 Device Comparison Table	3	9.2 Typical Application.....	19
6 Pin Configuration and Functions	3	9.3 Power Supply Recommendations.....	22
7 Specifications	6	9.4 Layout.....	22
7.1 Absolute Maximum Ratings.....	6	10 Device and Documentation Support	23
7.2 ESD Ratings.....	6	10.1 Device Support.....	23
7.3 Recommended Operating Conditions.....	6	10.2 Documentation Support.....	23
7.4 Thermal Information: OPA392.....	7	10.3 Receiving Notification of Documentation Updates.....	23
7.5 Thermal Information: OPA2392.....	7	10.4 Support Resources.....	23
7.6 Electrical Characteristics.....	8	10.5 Trademarks.....	23
7.7 Typical Characteristics.....	10	10.6 Electrostatic Discharge Caution.....	24
8 Detailed Description	17	10.7 Glossary.....	24
8.1 Overview.....	17	11 Mechanical, Packaging, and Orderable Information	24
8.2 Functional Block Diagram.....	17		

4 Revision History

NOTE: Page numbers for previous revisions may differ from page numbers in the current version.

Changes from Revision C (July 2022) to Revision D (December 2022)	Page
<ul style="list-style-type: none"> Changed OPA2392 in YBJ (DSBGA, 9) from advanced information (preview) to production data (active) and added associated content..... 	1
Changes from Revision B (October 2021) to Revision C (July 2022)	Page
<ul style="list-style-type: none"> Changed OPA2392 device to advanced information (preview)..... Changed Figure 6-9 Y-axis scales for clarity..... 	1 10
Changes from Revision A (August 2021) to Revision B (October 2021)	Page
<ul style="list-style-type: none"> Added footnote to input bias current and input offset current room temperature specification..... Added Figures 6-4, 6-5, and 6-6, <i>Offset Voltage vs Common-Mode Voltage</i>..... Changed Figure 6-9, <i>Open-Loop Gain and Phase vs Frequency</i>, to correct data..... Changed Figure 6-10, <i>Closed-Loop Gain and Phase vs Frequency</i>, to correct data..... Added Figure 6-14, <i>Input Bias Current vs Temperature</i>..... Changed Figure 6-23, <i>THD+N Ratio vs Frequency</i> to correct data..... 	8 10 10 10 10 10
Changes from Revision * (January 2021) to Revision A (August 2021)	Page
<ul style="list-style-type: none"> Changed OPA392 device in DBV (SOT-23-5) package from advanced information (preview) to production data (active)..... 	1

5 Device Comparison Table

DEVICE	CHANNELS	SHUTDOWN	PACKAGE
OPA392	Single	No	DBV (SOT-23, 5)
		No	DCK (SC70, 5)
		Yes	YBJ (DSBGA, 6)
OPA2392 (preview)	Dual	No	D (SOIC, 8)
		No	DGK (VSSOP, 8)
		Yes	YBJ (DSBGA, 9)
OPA4392 (preview)	Quad	No	PW (TSSOP, 14)
		Yes	RTE (WQFN, 16)

6 Pin Configuration and Functions

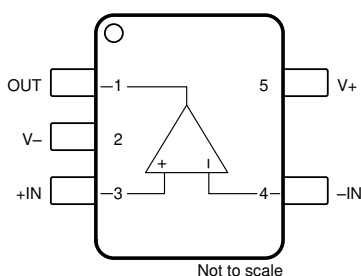

Figure 6-1. OPA392 DBV Package, 5-Pin SOT-23 (Top View)

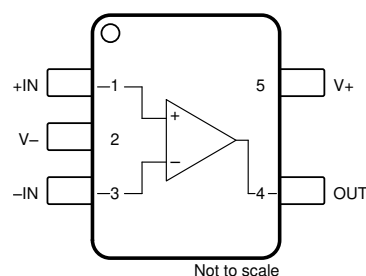

Figure 6-2. OPA392 DCK Preview Package, 5-Pin SC70 (Top View)

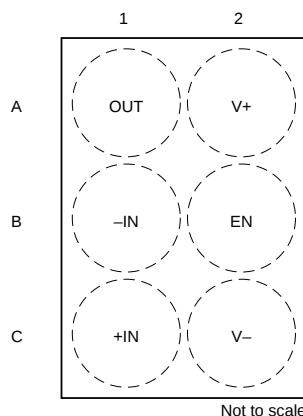
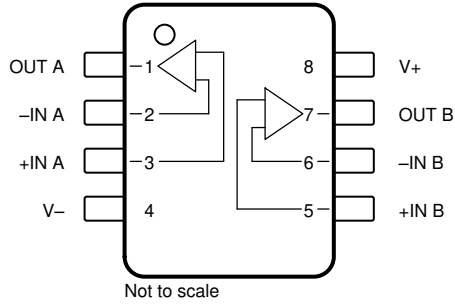

Figure 6-3. OPA392 YBJ Preview Package, 6-Pin DSBGA (Top View)

Table 6-1. Pin Functions: OPA392

NAME	PIN NO.			TYPE	DESCRIPTION
	DBV (SOT-23)	DCK (SC70)	YBJ (DSBGA)		
EN	—	—	B2	Input	Enable pin. High = amplifier enabled.
-IN	4	3	B1	Input	Inverting input
+IN	3	1	C1	Input	Noninverting input
OUT	1	4	A1	Output	Output
V-	2	2	C2	Power	Negative (lowest) power supply
V+	5	5	A2	Power	Positive (highest) power supply



Not to scale

Figure 6-4. OPA2392 D Preview Package, 8-Pin SOIC and DGK Preview Package, 8-Pin VSSOP (Top View)

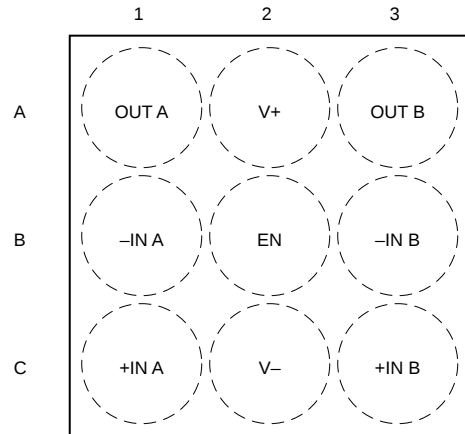

Not to scale

Figure 6-5. OPA2392 YBJ Package, 9-Pin DSBGA (Top View)

Table 6-2. Pin Functions: OPA2392

NAME	PIN		TYPE	DESCRIPTION
	NO.			
	D (SOIC), DGK (VSSOP)	YBJ (DSBGA)		
EN	—	B2	Input	Enable pin. High = both amplifiers enabled.
-IN A	2	B1	Input	Inverting input, channel A
+IN A	3	C1	Input	Noninverting input, channel A
-IN B	6	B3	Input	Inverting input, channel B
+IN B	5	C3	Input	Noninverting input, channel B
OUT A	1	A1	Output	Output, channel A
OUT B	7	A3	Output	Output, channel B
V-	4	C2	Power	Negative (lowest) power supply
V+	8	A2	Power	Positive (highest) power supply

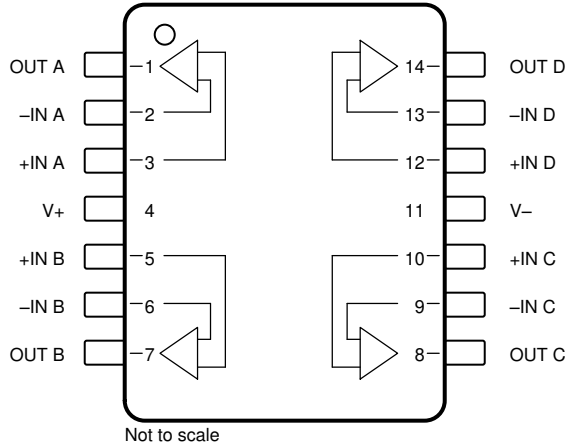

Figure 6-6. OPA4392 PW Preview Package, 14-Pin TSSOP (Top View)

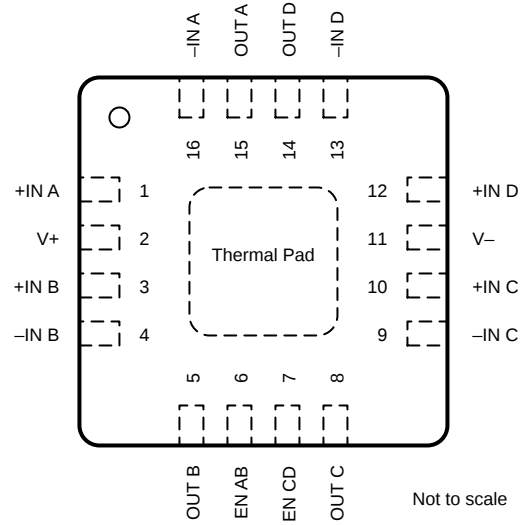

Figure 6-7. OPA4392 RTE Preview Package, 16-Pin WQFN (Top View)

Table 6-3. Pin Functions: OPA4392

NAME	PIN		TYPE	DESCRIPTION
	NO.			
	PW (TSSOP)	RTE (WQFN)		
EN AB	—	6	Input	Enable pin for A and B amplifiers. High = amplifiers A and B are enabled.
EN CD	—	7	Input	Enable pin for C and D amplifiers. High = amplifiers C and D are enabled.
-IN A	2	16	Input	Inverting input, channel A
+IN A	3	1	Input	Noninverting input, channel A
-IN B	6	4	Input	Inverting input, channel B
+IN B	5	3	Input	Noninverting input, channel B
-IN C	9	9	Input	Inverting input, channel C
+IN C	10	10	Input	Noninverting input, channel C
-IN D	13	13	Input	Inverting input, channel D
+IN D	12	12	Input	Noninverting input, channel D
OUT A	1	15	Output	Output, channel A
OUT B	7	5	Output	Output, channel B
OUT C	8	8	Output	Output, channel C
OUT D	14	14	Output	Output, channel D
Thermal Pad	—	Thermal Pad	Power	Connect thermal pad to V-
V-	11	11	Power	Negative (lowest) power supply
V+	4	2	Power	Positive (highest) power supply

7 Specifications

7.1 Absolute Maximum Ratings

over operating free-air temperature range (unless otherwise noted)⁽¹⁾

			MIN	MAX	UNIT
V _S	Supply voltage, V _S = (V+) – (V–)	Single-supply		6	V
		Dual-supply		±3	
	Input voltage, all pins	Common-mode	(V–) – 0.5	(V+) + 0.5	V
		Differential		(V+) – (V–) + 0.2	
	Input current, all pins			±10	mA
	Output short circuit ⁽²⁾		Continuous	Continuous	
T _A	Operating temperature		–55	150	°C
T _J	Junction temperature		–55	150	°C
T _{stg}	Storage temperature		–65	150	°C

- (1) Operation outside the Absolute Maximum Ratings may cause permanent device damage. Absolute Maximum Ratings do not imply functional operation of the device at these or any other conditions beyond those listed under Recommended Operating Conditions. If used outside the Recommended Operating Conditions but within the Absolute Maximum Ratings, the device may not be fully functional, and this may affect device reliability, functionality, performance, and shorten the device lifetime.
- (2) Short-circuit to ground, one amplifier per package.

7.2 ESD Ratings

			VALUE	UNIT
V _(ESD)	Electrostatic discharge	Human-body model (HBM), per ANSI/ESDA/JEDEC JS-001 ⁽¹⁾	2000	V
		Charged device model (CDM) per ANSI/ESDA/JEDEC JS-002 ⁽²⁾	500	

- (1) JEDEC document JEP155 states that 500-V HBM allows safe manufacturing with a standard ESD control process.
- (2) JEDEC document JEP157 states that 250-V CDM allows safe manufacturing with a standard ESD control process.

7.3 Recommended Operating Conditions

over operating free-air temperature range (unless otherwise noted)

			MIN	NOM	MAX	UNIT
V _S	Supply voltage	Single-supply	1.7		5.5	V
		Dual-supply	±0.85		±2.75	
T _A	Specified temperature		–40		125	°C

7.4 Thermal Information: OPA392

THERMAL METRIC ⁽¹⁾		OPA392	UNIT
		DBV (SOT-23)	
		5 PINS	
$R_{\theta JA}$	Junction-to-ambient thermal resistance	187.1	°C/W
$R_{\theta JC(top)}$	Junction-to-case (top) thermal resistance	107.4	°C/W
$R_{\theta JB}$	Junction-to-board thermal resistance	57.5	°C/W
Ψ_{JT}	Junction-to-top characterization parameter	33.5	°C/W
Ψ_{JB}	Junction-to-board characterization parameter	57.1	°C/W
$R_{\theta JC(bot)}$	Junction-to-case (bottom) thermal resistance	N/A	°C/W

(1) For more information about traditional and new thermal metrics, see the [Semiconductor and IC Package Thermal Metrics](#) application report.

7.5 Thermal Information: OPA2392

THERMAL METRIC ⁽¹⁾		OPA2392	UNIT
		YBJ (DSBGA)	
		9 PINS	
$R_{\theta JA}$	Junction-to-ambient thermal resistance	110.7	°C/W
$R_{\theta JC(top)}$	Junction-to-case (top) thermal resistance	0.7	°C/W
$R_{\theta JB}$	Junction-to-board thermal resistance	32.1	°C/W
Ψ_{JT}	Junction-to-top characterization parameter	0.3	°C/W
Ψ_{JB}	Junction-to-board characterization parameter	32.1	°C/W
$R_{\theta JC(bot)}$	Junction-to-case (bottom) thermal resistance	N/A	°C/W

(1) For more information about traditional and new thermal metrics, see the [Semiconductor and IC Package Thermal Metrics](#) application report.

7.6 Electrical Characteristics

at $T_A = 25^\circ\text{C}$, $V_S = 1.7\text{ V}$ to 5.5 V (single-supply) or $V_S = \pm 0.85\text{ V}$ to $\pm 2.75\text{ V}$ (dual-supply), $R_L = 10\text{ k}\Omega$ connected to $V_S / 2$, $V_{CM} = V_S / 2$, and $V_{OUT} = V_S / 2$ (unless otherwise noted)

PARAMETER		TEST CONDITIONS		MIN	TYP	MAX	UNIT
OFFSET VOLTAGE							
V_{OS}	Input offset voltage	$V_S = 5.0\text{ V}$			± 1	± 10	μV
			OPA2392YBJ		± 1	± 25	
		$V_S = 5.0\text{ V}$, $V_{CM} = (V+) - 200\text{ mV}$			± 2	± 30	
			OPA2392YBJ		± 2	± 85	
		$V_S = 5.0\text{ V}$, $T_A = -40^\circ\text{C}$ to $+125^\circ\text{C}^{(1)}$				± 100	
		$V_{CM} = (V-)$, $T_A = -40^\circ\text{C}$ to $+125^\circ\text{C}^{(1)}$				± 125	
dV_{OS}/dT	Input offset voltage drift	$V_S = 5.0\text{ V}$	$T_A = 0^\circ\text{C}$ to 85°C		± 0.16		$\mu\text{V}/^\circ\text{C}$
			$T_A = -40^\circ\text{C}$ to $+125^\circ\text{C}^{(1)}$			± 0.6	
			$V_{CM} = 5.0\text{ V}$, $T_A = -40^\circ\text{C}$ to $+125^\circ\text{C}^{(1)}$		± 0.18	± 0.9	
PSRR	Power supply rejection ratio	$V_{CM} = (V-)$				± 30	$\mu\text{V}/\text{V}$
			$T_A = -40^\circ\text{C}$ to $+125^\circ\text{C}^{(1)}$			± 80	
INPUT BIAS CURRENT							
I_B	Input bias current ⁽¹⁾				± 0.01	± 0.8	pA
			$T_A = -40^\circ\text{C}$ to $+85^\circ\text{C}$			± 5	
			$T_A = -40^\circ\text{C}$ to $+125^\circ\text{C}$			± 30	
I_{OS}	Input offset current ⁽¹⁾				± 0.01	± 0.8	pA
			$T_A = -40^\circ\text{C}$ to $+85^\circ\text{C}$			± 5	
			$T_A = -40^\circ\text{C}$ to $+125^\circ\text{C}$			± 30	
NOISE							
	Input voltage noise	$f = 0.1\text{ Hz}$ to 10 Hz			2.0		μV_{PP}
			$V_{CM} = (V+) - 0.3$		3.2		
e_N	Input voltage noise density	$f = 10\text{ Hz}$			42		$\text{nV}/\sqrt{\text{Hz}}$
			$V_{CM} = (V+) - 0.3$		80		
		$f = 1\text{ kHz}$			6.5		
			$V_{CM} = (V+) - 0.3$		10.4		
		$f = 10\text{ kHz}$			4.4		
			$V_{CM} = (V+) - 0.3$		5.8		
i_N	Input current noise density	$f = 1\text{ kHz}$	OPA392		70		$\text{fA}/\sqrt{\text{Hz}}$
			OPA2392		25		
INPUT VOLTAGE							
V_{CM}	Common-mode voltage range			(V-)		(V+)	V
CMRR	Common-mode rejection ratio	$(V-) < V_{CM} < (V+) - 1.5\text{ V}$		75	120		dB
			$T_A = -40^\circ\text{C}$ to $+125^\circ\text{C}$		113		
		$(V-) < V_{CM} < (V+)$, $T_A = -40^\circ\text{C}$ to $+125^\circ\text{C}^{(1)}$	$V_S = 5.5\text{ V}$	88	111		
INPUT CAPACITANCE							
Z_{ID}	Differential				$10^{13} \parallel 2.8$		$\Omega \parallel \text{pF}$
Z_{ICM}	Common-mode				$10^{13} \parallel 3.5$		$\Omega \parallel \text{pF}$

7.6 Electrical Characteristics (continued)

at $T_A = 25^\circ\text{C}$, $V_S = 1.7\text{ V}$ to 5.5 V (single-supply) or $V_S = \pm 0.85\text{ V}$ to $\pm 2.75\text{ V}$ (dual-supply), $R_L = 10\text{ k}\Omega$ connected to $V_S / 2$, $V_{CM} = V_S / 2$, and $V_{OUT} = V_S / 2$ (unless otherwise noted)

PARAMETER		TEST CONDITIONS		MIN	TYP	MAX	UNIT	
OPEN-LOOP GAIN								
A _{OL}	Open-loop voltage gain	V _S = 5.5 V	(V ⁻) + 50 mV < V _{OUT} < (V ⁺) – 50 mV	115	132		dB	
			(V ⁻) + 100 mV < V _O < (V ⁺) – 100 mV, R _L = 2 kΩ	110	128			
			(V ⁻) + 100 mV < V _{OUT} < (V ⁺) – 100 mV, R _L = 2 kΩ, T _A = –40°C to +125°C ⁽¹⁾	100				
		V _S = 1.7 V	(V ⁻) + 50 mV < V _{OUT} < (V ⁺) – 50 mV, V _{CM} = (V ⁺) – 1.15 V	106	124			
			(V ⁻) + 100 mV < V _{OUT} < (V ⁺) – 100 mV, R _L = 2 kΩ, V _{CM} = (V ⁺) – 1.15 V	106	124			
			(V ⁻) + 100 mV < V _{OUT} < (V ⁺) – 100 mV, R _L = 2 kΩ, V _{CM} = (V ⁺) – 1.15 V, T _A = –40°C to +125°C ⁽¹⁾	100				
FREQUENCY RESPONSE								
GBW	Gain-bandwidth product	A _V = 1000 V/V			13		MHz	
SR	Slew rate	4-V step, gain = +1	falling		4.5		V/μs	
			rising		3.5			
	Phase margin	C _L = 100 pF			45		°	
t _S	Settling time	To 0.1%, 2-V step, gain = +1			0.75		μs	
		To 0.01%, 2-V step, gain = +1			1			
	Overload recovery time	V _{IN} × gain > V _S			0.45		μs	
THD+N	Total harmonic distortion + noise	V _{OUT} = 1 V _{RMS} , gain = +1, f = 1 kHz, V _{CM} = (V ⁻) + 1.5 V			–112		dB	
					0.00025			%
OUTPUT								
	Voltage output swing from both rails	V _S = 1.7 V				20	mV	
			R _L = 2 kΩ					30
		V _S = 5.5 V						20
			R _L = 2 kΩ					35
I _{SC}	Short-circuit current	Sinking, V _S = 5.5 V			–55		mA	
		Sourcing, V _S = 5.5 V			65			
R _O	Open-loop output impedance	f = 1 MHz			120		Ω	
POWER SUPPLY								
I _Q	Quiescent current per amplifier	I _O = 0 mA			1.22	1.4	mA	
				T _A = –40°C to +125°C ⁽¹⁾		1.5		
SHUTDOWN (OPA392YBJ, OPA2392YBJ and OPA4392RTE Only)								
I _{QSD}	Quiescent current per amplifier	All amplifiers disabled, EN = (V ⁻)			6		μA	
V _{IH}	High-level input voltage	Amplifier enabled		(V ⁺) – 0.5			V	
V _{IL}	Low-level input voltage	Amplifier disabled				(V ⁻) + 0.5	V	
t _{ON}	Amplifier enable time	G = 1, V _{OUT} = 0.9 × V _S /2, two amplifiers enabled			9.5		μs	
t _{OFF}	Amplifier disable time	G = 1, V _{OUT} = 0.1 × V _S /2, two amplifiers disabled			7.8		μs	
	EN pin input leakage current	V _{IH} = (V ⁺)			0.02		μA	
		V _{IL} = (V ⁻)			1			

(1) Specification established from device population bench system measurements across multiple lots.

7.7 Typical Characteristics

at $T_A = 25^\circ\text{C}$, $V_S = 5.5\text{ V}$, $V_{CM} = V_S / 2$, $R_{LOAD} = 10\text{ k}\Omega$ connected to $V_S / 2$, and $C_L = 100\text{ pF}$ (unless otherwise noted)

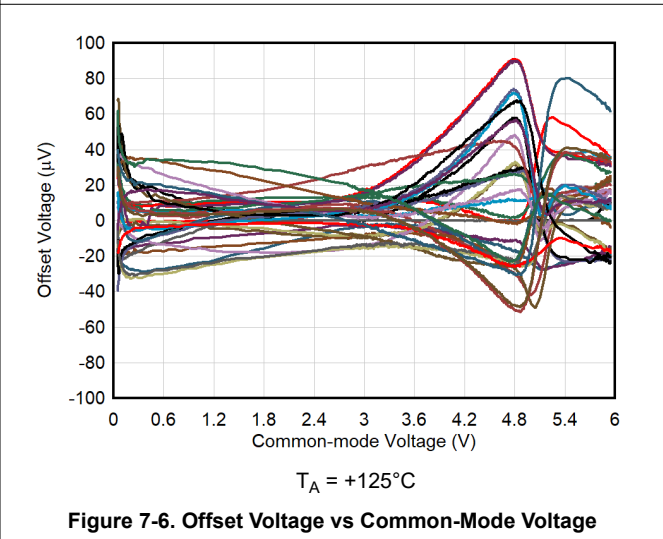
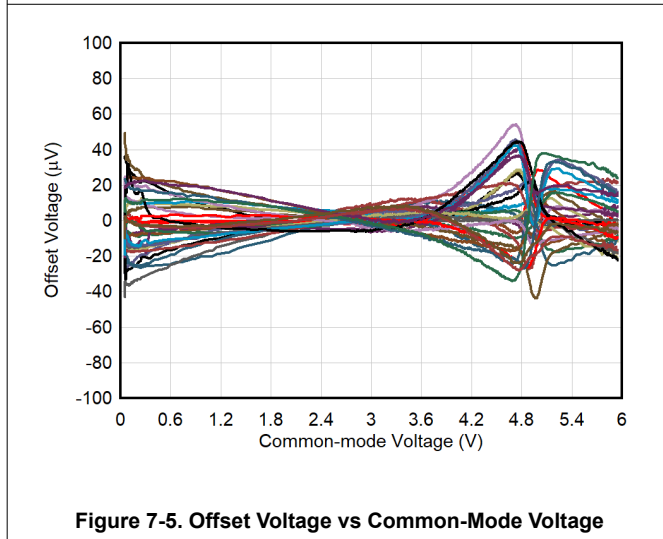
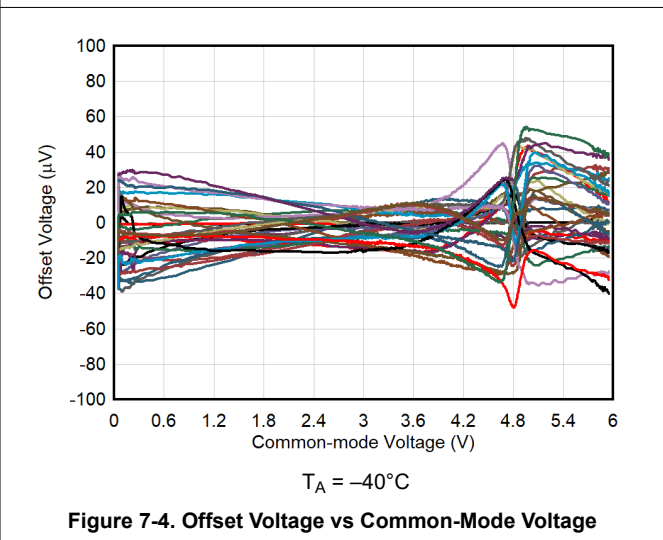
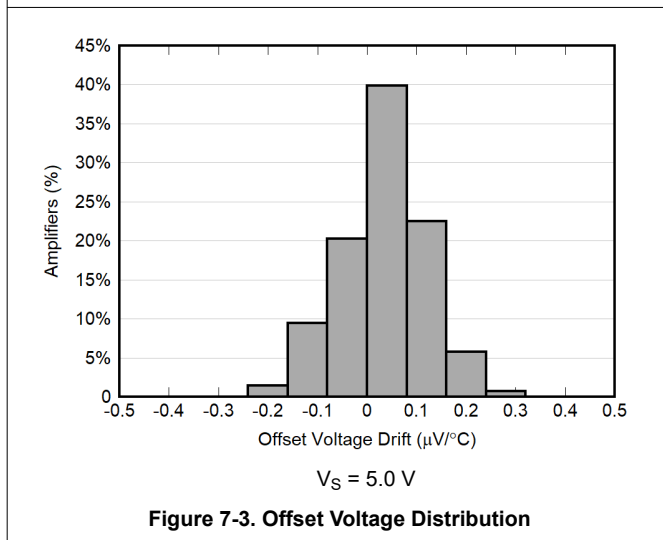
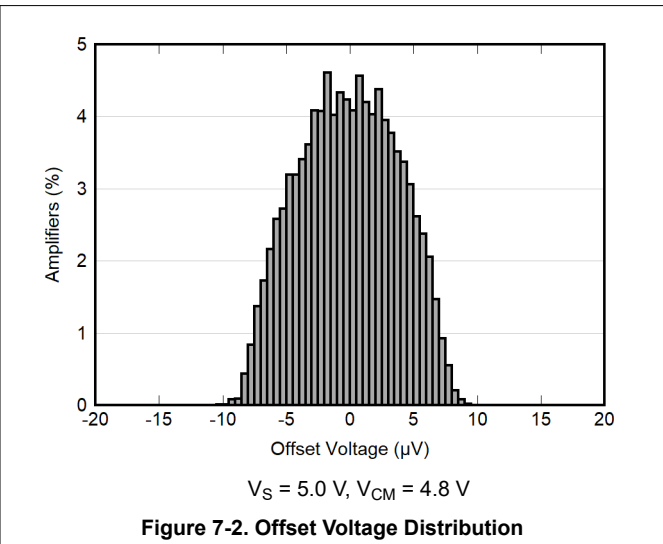
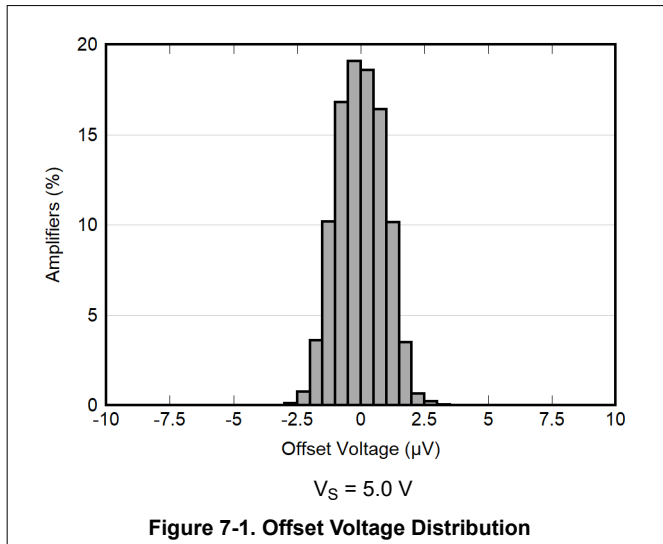

7.7 Typical Characteristics (continued)

at $T_A = 25^\circ\text{C}$, $V_S = 5.5\text{ V}$, $V_{CM} = V_S / 2$, $R_{LOAD} = 10\text{ k}\Omega$ connected to $V_S / 2$, and $C_L = 100\text{ pF}$ (unless otherwise noted)

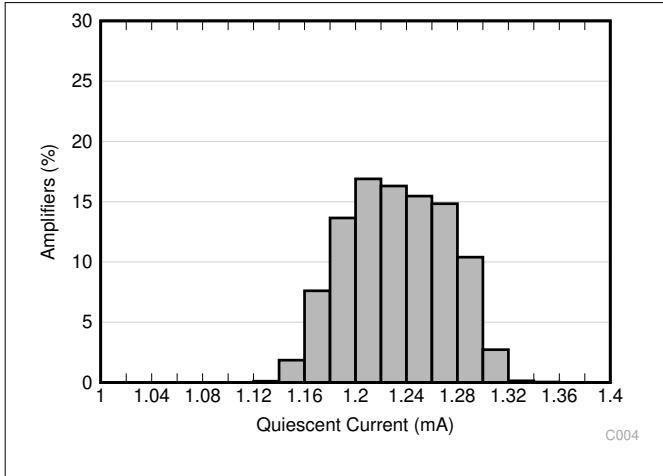

Figure 7-7. Quiescent Current Distribution

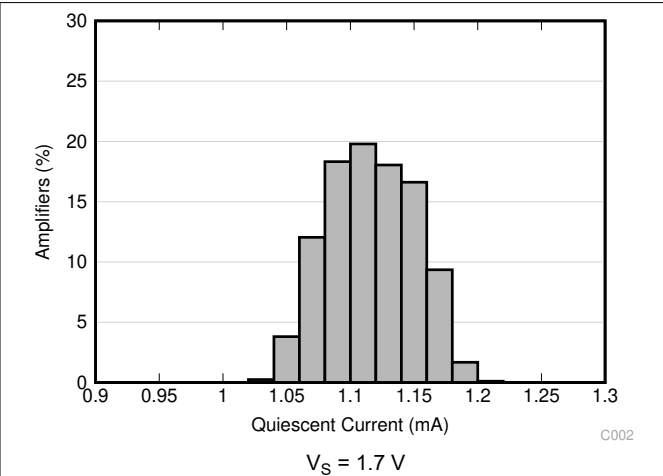

Figure 7-8. Quiescent Current Distribution

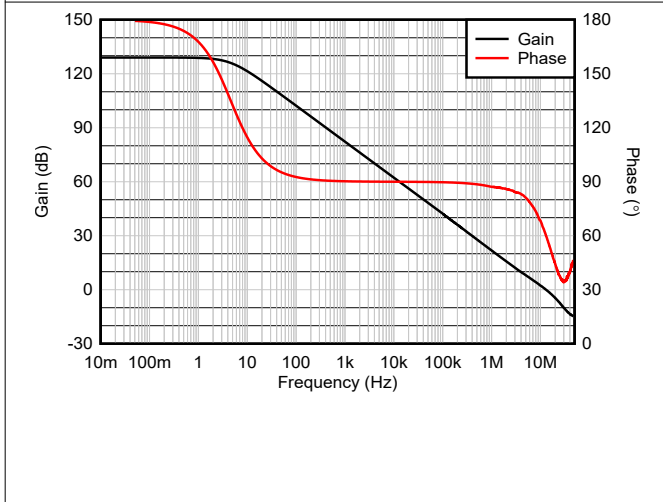

Figure 7-9. Open-Loop Gain and Phase vs Frequency

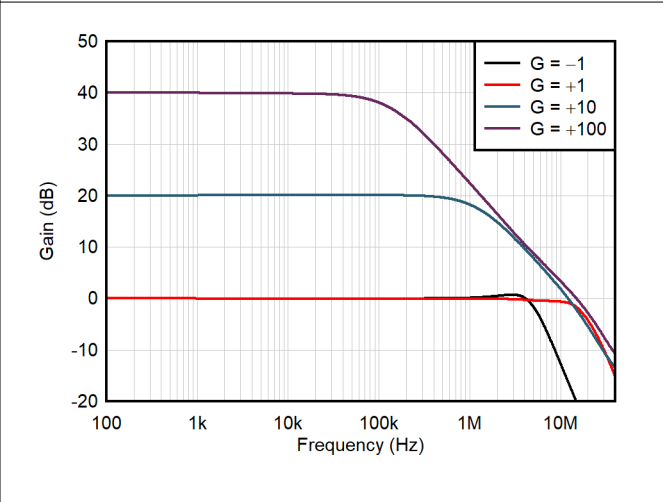

Figure 7-10. Closed-Loop Gain vs Frequency

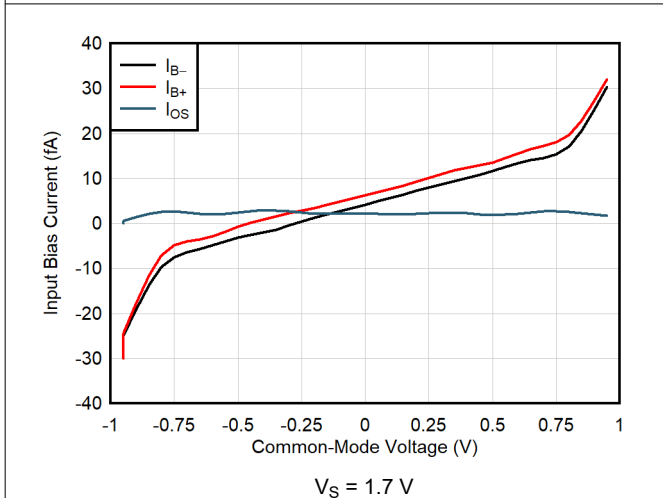

Figure 7-11. Input Bias Current vs Common-Mode Voltage

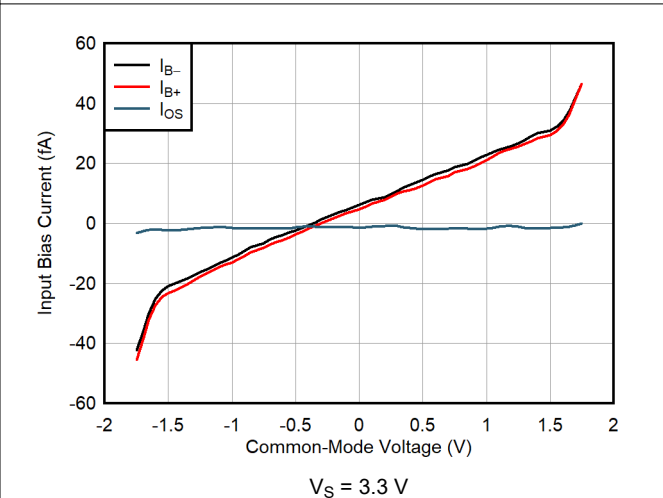

Figure 7-12. Input Bias Current vs Common-Mode Voltage

7.7 Typical Characteristics (continued)

at $T_A = 25^\circ\text{C}$, $V_S = 5.5\text{ V}$, $V_{CM} = V_S / 2$, $R_{LOAD} = 10\text{ k}\Omega$ connected to $V_S / 2$, and $C_L = 100\text{ pF}$ (unless otherwise noted)

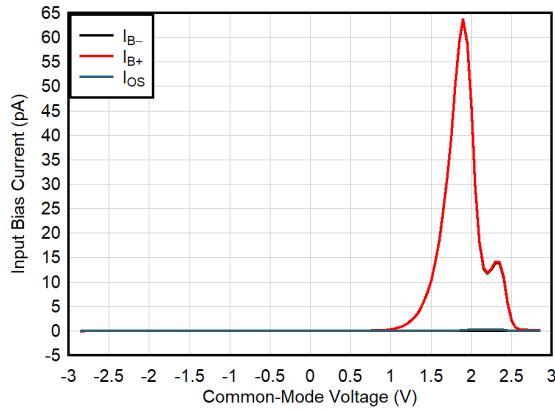

Figure 7-13. Input Bias Current vs Common-Mode Voltage

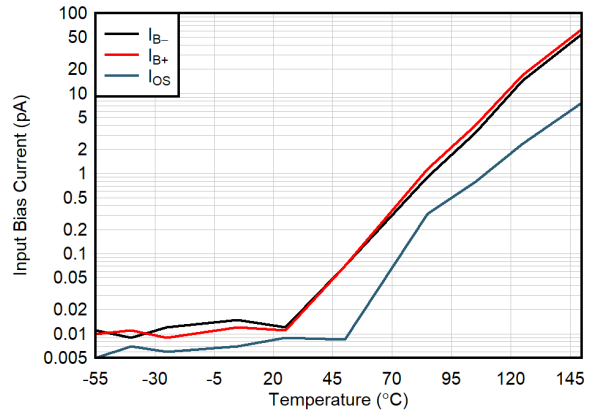

Figure 7-14. Input Bias Current vs Temperature

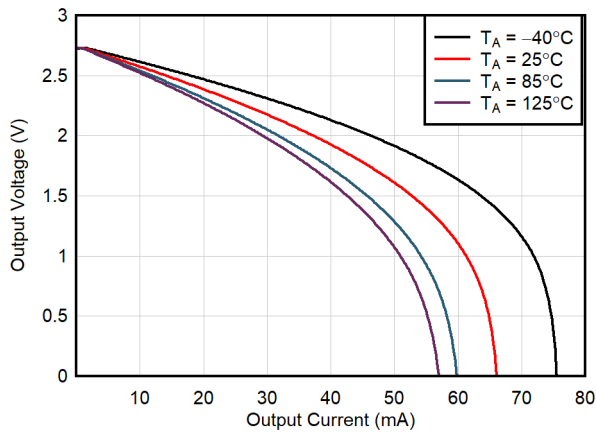

Figure 7-15. Output Voltage Swing vs Output Current (Sourcing)

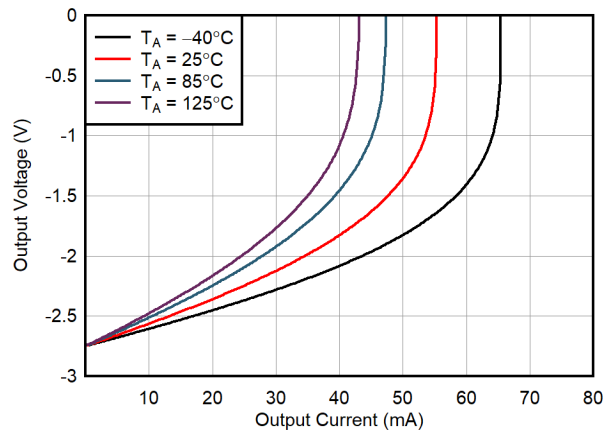

Figure 7-16. Output Voltage Swing vs Output Current (Sinking)

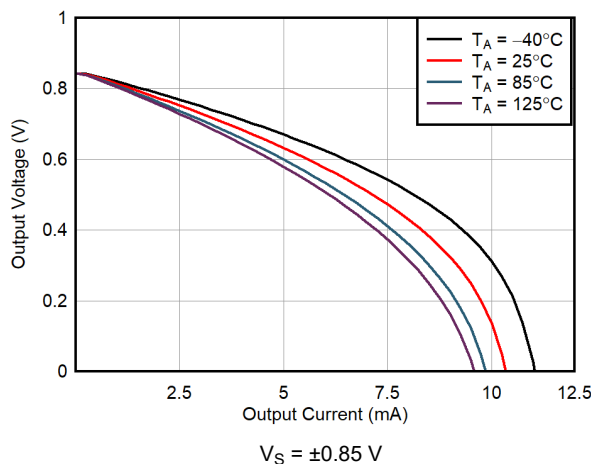

Figure 7-17. Output Voltage Swing vs Output Current (Sourcing)

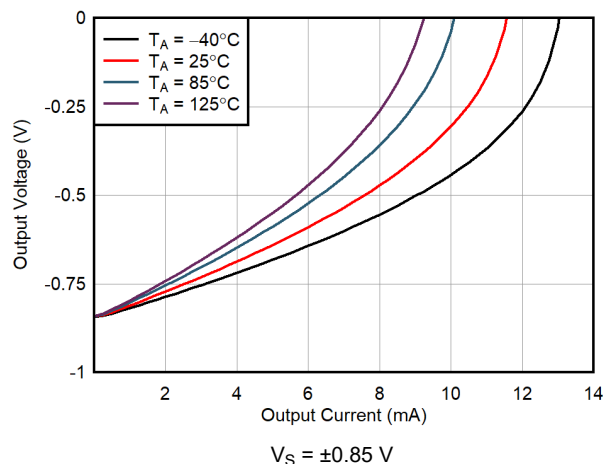
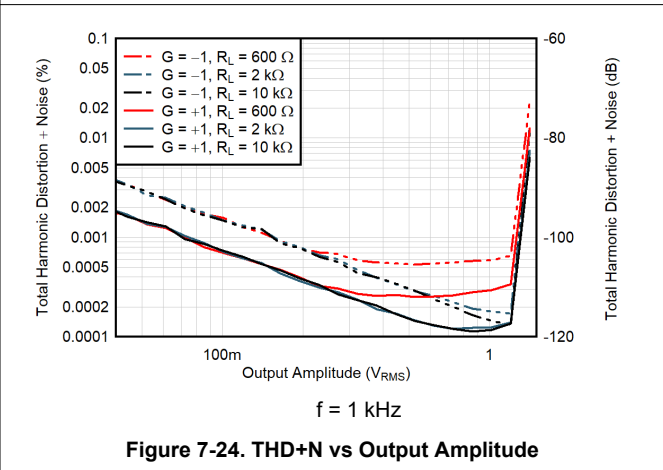
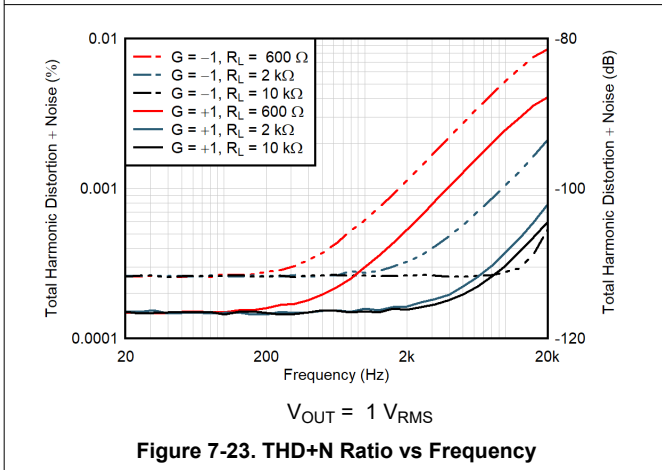
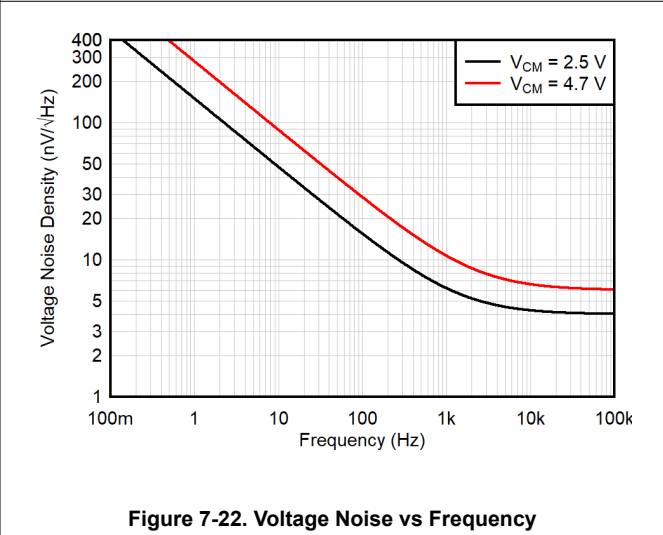
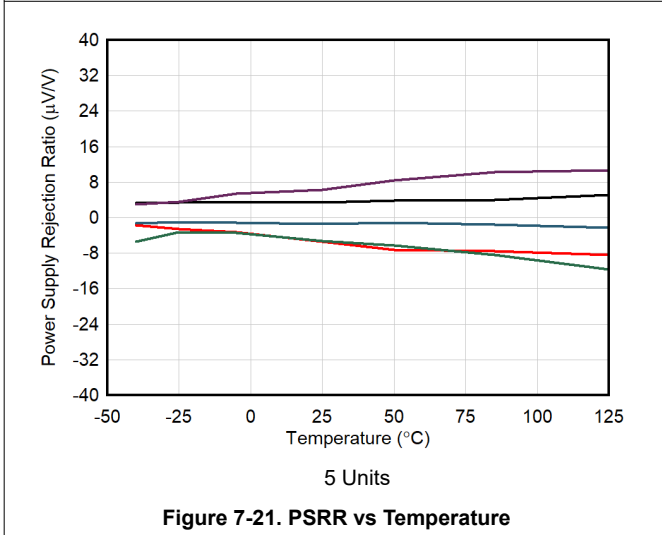
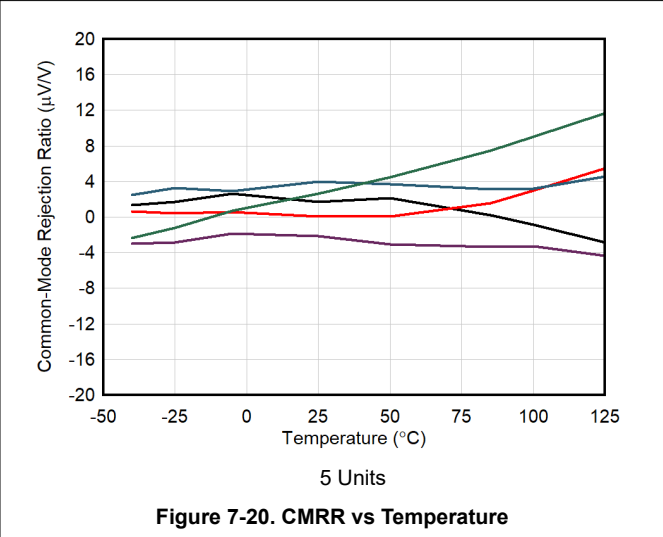
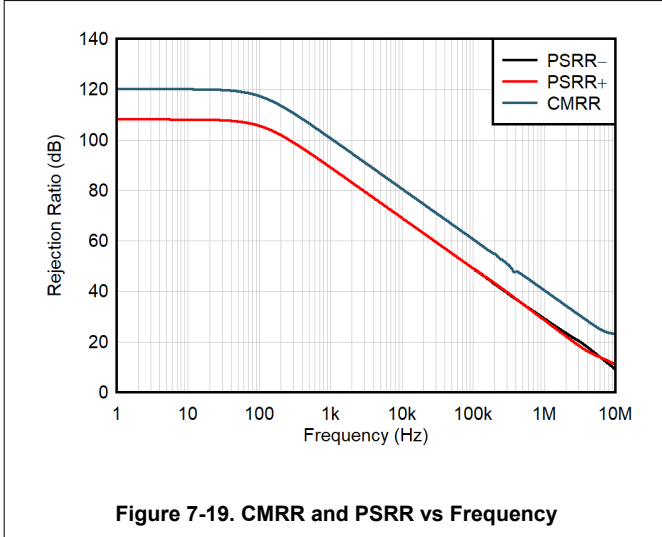

Figure 7-18. Output Voltage Swing vs Output Current (Sinking)

7.7 Typical Characteristics (continued)

at $T_A = 25^\circ\text{C}$, $V_S = 5.5\text{ V}$, $V_{CM} = V_S / 2$, $R_{LOAD} = 10\text{ k}\Omega$ connected to $V_S / 2$, and $C_L = 100\text{ pF}$ (unless otherwise noted)



7.7 Typical Characteristics (continued)

at $T_A = 25^\circ\text{C}$, $V_S = 5.5\text{ V}$, $V_{CM} = V_S / 2$, $R_{LOAD} = 10\text{ k}\Omega$ connected to $V_S / 2$, and $C_L = 100\text{ pF}$ (unless otherwise noted)

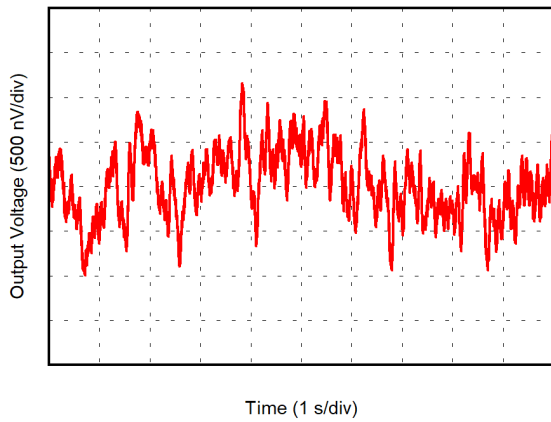
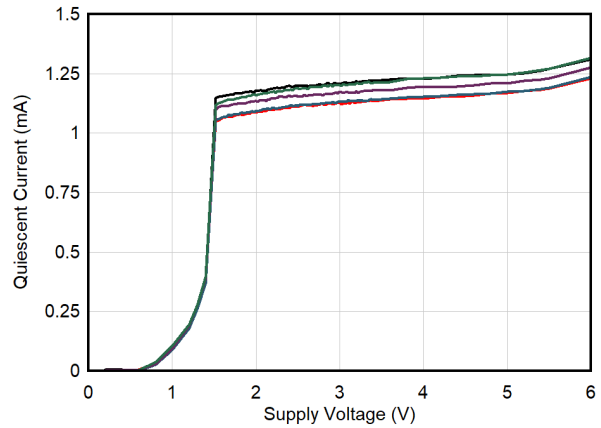
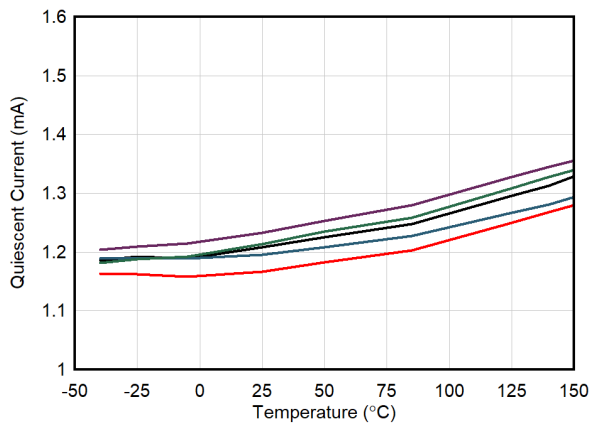

Figure 7-25. 0.1-Hz to 10-Hz Noise



5 Units

Figure 7-26. Quiescent Current vs Supply Voltage



5 Units

Figure 7-27. Quiescent Current vs Temperature

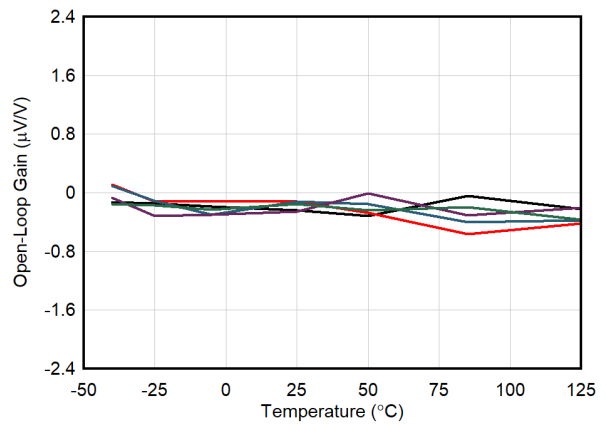

5 Units

Figure 7-28. Open-Loop Gain vs Temperature

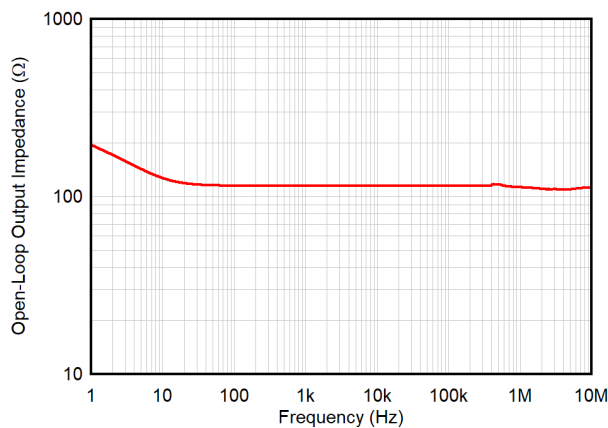
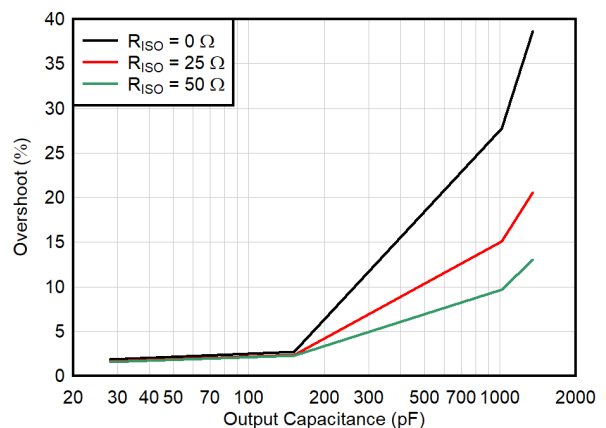

Figure 7-29. Open-Loop Output Impedance vs Frequency



$G = -1$

Figure 7-30. Small-Signal Overshoot vs Capacitive Load (10-mV Step)

7.7 Typical Characteristics (continued)

at $T_A = 25^\circ\text{C}$, $V_S = 5.5\text{ V}$, $V_{CM} = V_S / 2$, $R_{LOAD} = 10\text{ k}\Omega$ connected to $V_S / 2$, and $C_L = 100\text{ pF}$ (unless otherwise noted)

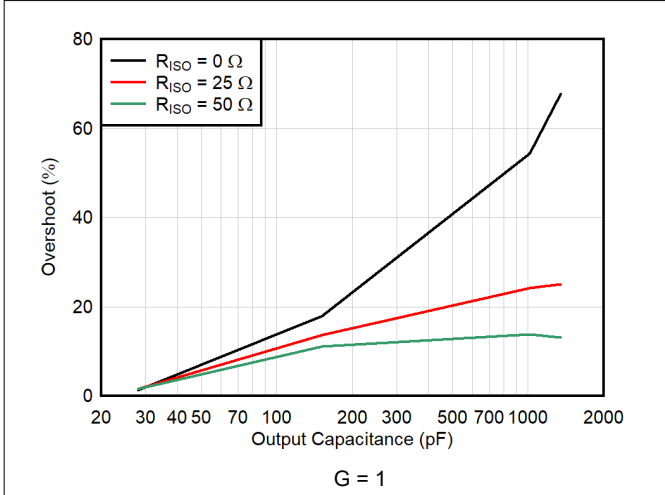

Figure 7-31. Small-Signal Overshoot vs Capacitive Load (10-mV Step)

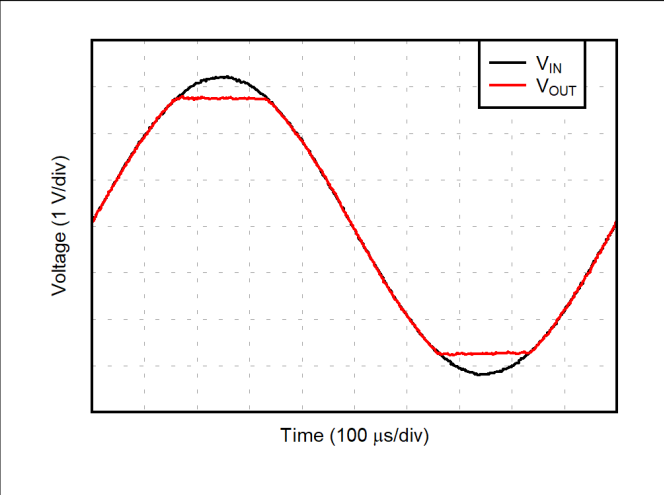

Figure 7-32. No Phase Reversal

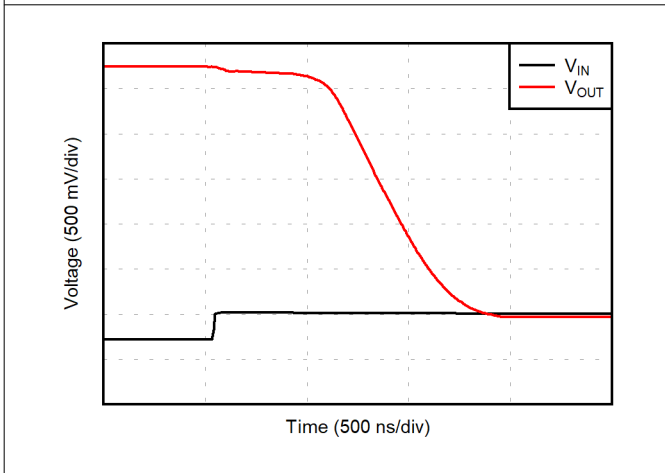

Figure 7-33. Positive Overload Recovery

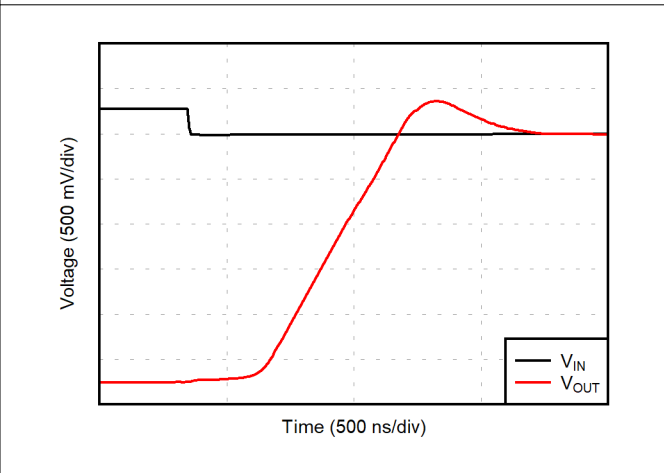

Figure 7-34. Negative Overload Recovery

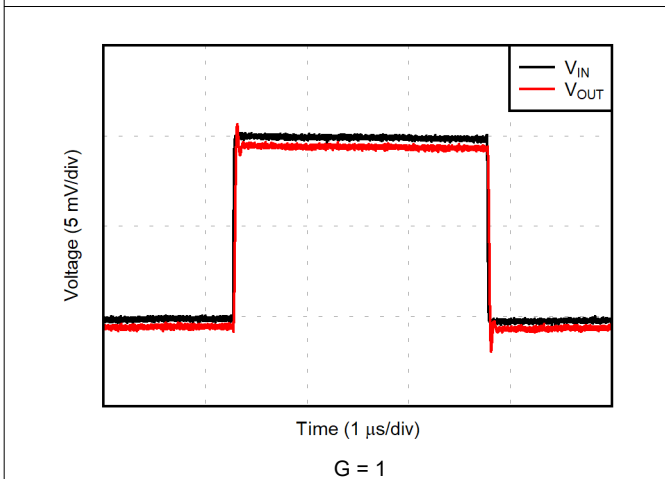

Figure 7-35. Small-Signal Step Response (10-mV Step)

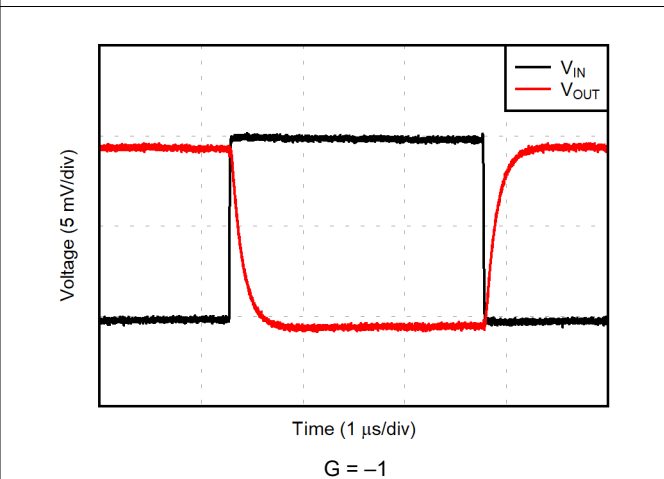

Figure 7-36. Small-Signal Step Response (10-mV Step)

7.7 Typical Characteristics (continued)

at $T_A = 25^\circ\text{C}$, $V_S = 5.5\text{ V}$, $V_{CM} = V_S / 2$, $R_{LOAD} = 10\text{ k}\Omega$ connected to $V_S / 2$, and $C_L = 100\text{ pF}$ (unless otherwise noted)

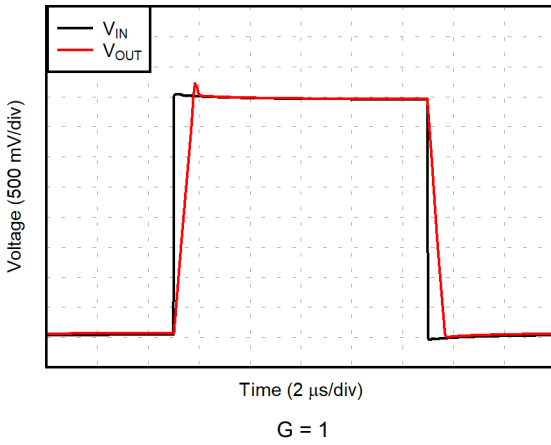

Figure 7-37. Large-Signal Step Response (4-V Step)

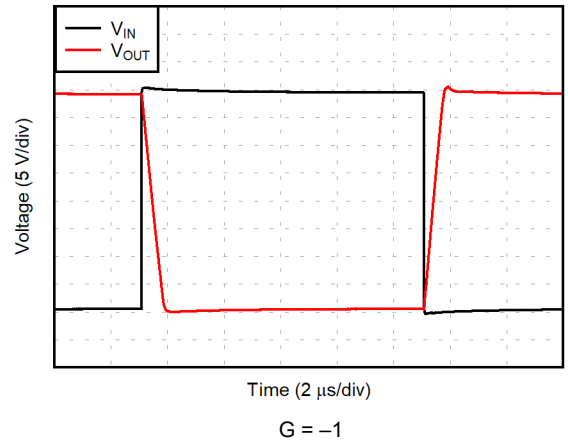

Figure 7-38. Large-Signal Step Response (4-V Step)

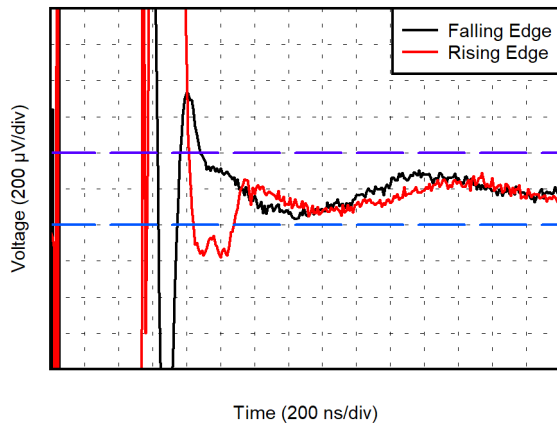

Figure 7-39. Settling Time

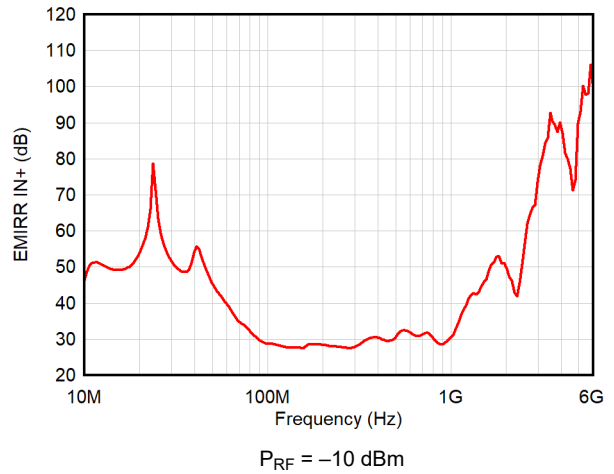

Figure 7-40. EMIRR vs Frequency

8 Detailed Description

8.1 Overview

The OPAx392 is a family of low offset, low-noise e-trim operational amplifiers (op amps) that uses a proprietary offset trim technique. These op amps offer ultra-low input offset voltage and drift and achieve excellent input and output dynamic linearity. The OPAx392 operate from 1.7 V to 5.5 V, are unity-gain stable, and are designed for a wide range of general-purpose and precision applications.

The amplifiers feature state-of-the-art CMOS technology and advanced design features that help achieve extremely low input bias current, wide input and output voltage ranges, high loop gain, and low, flat output impedance in small package options. The OPAx392 strengths also include 13-MHz bandwidth, 4.4-nV/ $\sqrt{\text{Hz}}$ noise spectral density, and low $1/f$ noise. These features make the OPAx392 an exceptional choice for interfacing with sensors, photodiodes, and high-performance analog-to-digital converters (ADCs).

8.2 Functional Block Diagram

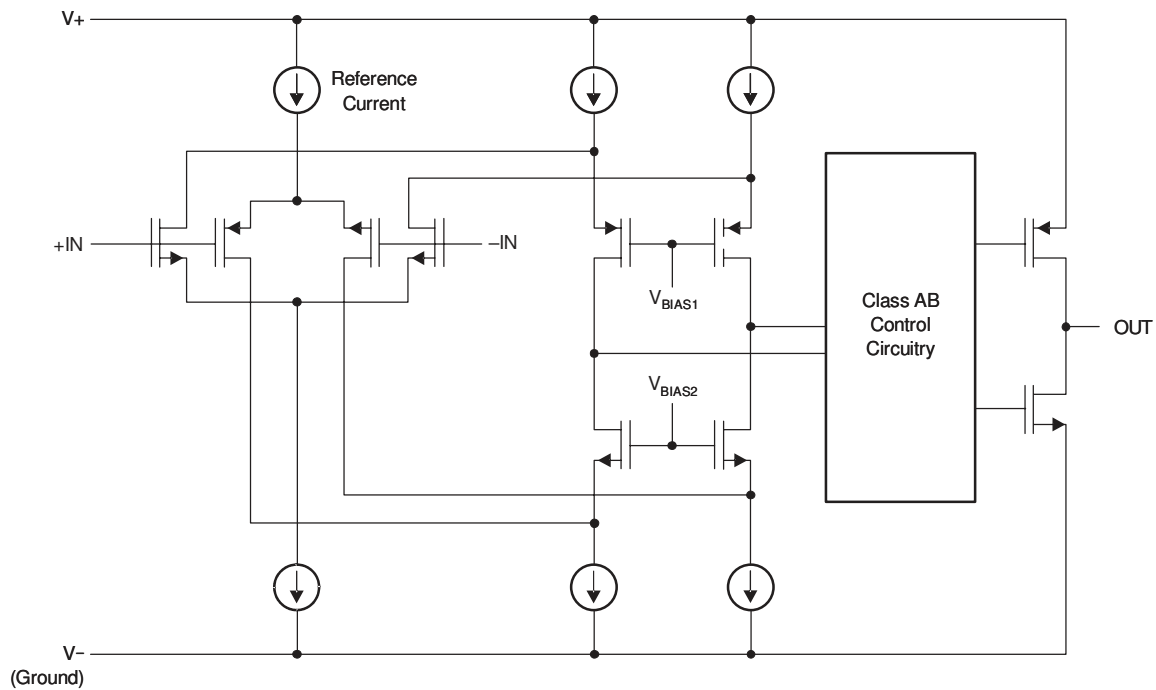

8.3 Feature Description

8.3.1 Low Operating Voltage

The OPAx392 family can be used with single or dual supplies from an operating range of $V_S = 1.7\text{ V}$ ($\pm 0.85\text{ V}$) up to 5.5 V ($\pm 2.75\text{ V}$). The offset voltage is trimmed at 5.0 V , however, the device maintains ultra-low offset voltages down to $V_S = 1.7\text{ V}$.

Key parameters that vary over the supply voltage or temperature range are shown in the *Typical Characteristics*.

8.3.2 Low Input Bias Current

The typical input bias current of the OPAx392 is extremely low (typically 10 fA). Input bias current is dominated by leakage current from the ESD protection diodes, which is proportional to the area of the diode. The OPAx392 is able to achieve ultra-low input bias current as a result of modern process technology and advanced electrostatic discharge (ESD) protection design that minimizes the area of the diode.

In overdriven conditions, the bias current can increase significantly. The most common cause of an overdriven condition occurs when the operational amplifier is outside of the linear range of operation. When the output of the operational amplifier is driven to one of the supply rails, the feedback loop requirements cannot be satisfied and a differential input voltage develops across the input pins. This differential input voltage results in the forward-biasing of the ESD cells. [Figure 8-1](#) shows the equivalent circuit.

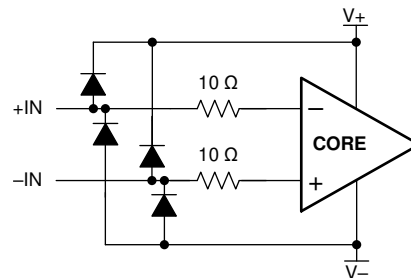

Figure 8-1. Equivalent Input Circuit

8.4 Device Functional Modes

The OPAx392 family is operational when the power-supply voltage is greater than 1.7 V ($\pm 0.85\text{ V}$). For devices that use the EN function (see [Section 6](#)), the devices are disabled when the EN pin is low. In this state, quiescent current is significantly reduced, and the output is high impedance. The maximum specified power-supply voltage for the OPAx392 is 5.5 V ($\pm 2.75\text{ V}$).

9 Application and Implementation

Note

Information in the following applications sections is not part of the TI component specification, and TI does not warrant its accuracy or completeness. TI's customers are responsible for determining suitability of components for their purposes, as well as validating and testing their design implementation to confirm system functionality.

9.1 Application Information

The OPAx392 is a unity-gain stable, precision operational amplifier family free from unexpected output and phase reversal. The use of proprietary e-trim operational amplifier technology gives the benefit of low input offset voltage over time and temperature, along with ultra-low input bias current. The OPAx392 are optimized for full rail-to-rail input, allowing for low-voltage, single-supply operation or split-supply use. These miniature, high-precision, low-noise amplifiers offer high-impedance inputs that have a common-mode range to the supply rail, with low offset across the supply range, and a rail-to-rail output that swings within 5 mV of the supplies under normal test conditions. The OPAx392 precision amplifiers are designed for upstream analog signal chain applications in low or high gains, as well as downstream signal chain functions such as DAC buffering.

9.2 Typical Application

This single-supply, low-side, bidirectional current-sensing design example detects load currents from -1 A to $+1$ A. The single-ended output spans from 110 mV to 3.19 V. This design uses the OPA392 because of the low offset voltage and rail-to-rail input and output. One of the amplifiers is configured as a difference amplifier and the other amplifier provides the reference voltage.

Figure 9-1 shows the schematic.

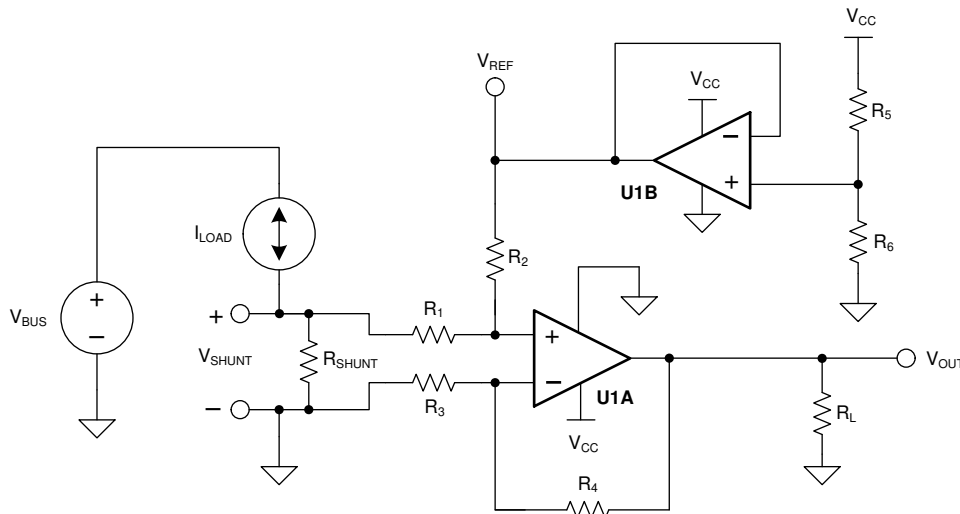

Figure 9-1. Bidirectional Current-Sensing Schematic

9.2.1 Design Requirements

This design example has the following requirements:

- Supply voltage: 3.3 V
- Input: –1 A to +1 A
- Output: 1.65 V ±1.54 V (110 mV to 3.19 V)

9.2.2 Detailed Design Procedure

The load current, I_{LOAD} , flows through the shunt resistor, R_{SHUNT} , to develop the shunt voltage, V_{SHUNT} . The shunt voltage is then amplified by the difference amplifier consisting of U1A and R_1 through R_4 . The gain of the difference amplifier is set by the ratio of R_4 to R_3 . To minimize errors, set $R_2 = R_4$ and $R_1 = R_3$. The reference voltage, V_{REF} , is supplied by buffering a resistor divider using U1B. The transfer function is given by [Equation 1](#).

$$V_{OUT} = V_{SHUNT} \times \text{Gain}_{\text{Diff_Amp}} + V_{REF} \quad (1)$$

where

- $V_{SHUNT} = I_{LOAD} \times R_{SHUNT}$
- $\text{Gain}_{\text{Diff_Amp}} = \frac{R_4}{R_3}$
- $V_{REF} = V_{CC} \times \left(\frac{R_6}{R_5 + R_6} \right)$

There are two types of errors in this design: offset and gain. Gain errors are introduced by the tolerance of the shunt resistor and the ratios of R_4 to R_3 and, similarly, R_2 to R_1 . Offset errors are introduced by the voltage divider (R_5 and R_6) and how closely the ratio of R_4 / R_3 matches R_2 / R_1 . The latter value affects the CMRR of the difference amplifier, ultimately translating to an offset error.

The value of V_{SHUNT} is the ground potential for the system load because V_{SHUNT} is a low-side measurement. Therefore, a maximum value must be placed on V_{SHUNT} . In this design, the maximum value for V_{SHUNT} is set to 100 mV. [Equation 2](#) calculates the maximum value of the shunt resistor given a maximum shunt voltage of 100 mV and maximum load current of 1 A.

$$R_{SHUNT(\text{Max})} = \frac{V_{SHUNT(\text{Max})}}{I_{LOAD(\text{Max})}} = \frac{100 \text{ mV}}{1 \text{ A}} = 100 \text{ m}\Omega \quad (2)$$

The tolerance of R_{SHUNT} is directly proportional to cost. For this design, a shunt resistor with a tolerance of 0.5% is selected. If greater accuracy is required, select a 0.1% resistor or better.

The load current is bidirectional; therefore, the shunt voltage range is –100 mV to +100 mV. This voltage is divided down by R_1 and R_2 before reaching the operational amplifier, U1A. Make sure that the voltage present at the noninverting node of U1A is within the common-mode range of the device. Therefore, use an operational amplifier, such as the OPA392, that has a common-mode range that extends below the negative supply voltage. Finally, to minimize offset error, the OPA392 has a typical offset voltage of merely $\pm 0.25 \mu\text{V}$ ($\pm 5 \mu\text{V}$ maximum).

Given a symmetric load current of –1 A to +1 A, the voltage divider resistors (R_5 and R_6) must be equal. To be consistent with the shunt resistor, a tolerance of 0.5% is selected. To minimize power consumption, 10-k Ω resistors are used.

To set the gain of the difference amplifier, the common-mode range and output swing of the OPA392 must be considered. Equation 3 and Equation 4 depict the typical common-mode range and maximum output swing, respectively, of the OPA392 given a 3.3-V supply.

$$-100 \text{ mV} < V_{\text{CM}} < 3.4 \text{ V} \quad (3)$$

$$100 \text{ mV} < V_{\text{OUT}} < 3.2 \text{ V} \quad (4)$$

The gain of the difference amplifier can now be calculated as shown in Equation 5:

$$\text{Gain}_{\text{Diff_Amp}} = \frac{V_{\text{OUT_Max}} - V_{\text{OUT_Min}}}{R_{\text{SHUNT}} \times (I_{\text{MAX}} - I_{\text{MIN}})} = \frac{3.2 \text{ V} - 100 \text{ mV}}{100 \text{ m}\Omega \times [1 \text{ A} - (-1 \text{ A})]} = 15.5 \frac{\text{V}}{\text{V}} \quad (5)$$

The resistor value selected for R₁ and R₃ is 1 kΩ. 15.4 kΩ is selected for R₂ and R₄ because this number is the nearest standard value. Therefore, the ideal gain of the difference amplifier is 15.4 V/V.

The gain error of the circuit primarily depends on R₁ through R₄. As a result of this dependence, 0.1% resistors are selected. This configuration reduces the likelihood that the design requires a two-point calibration. A simple one-point calibration, if desired, removes the offset errors introduced by the 0.5% resistors.

9.2.3 Application Curve

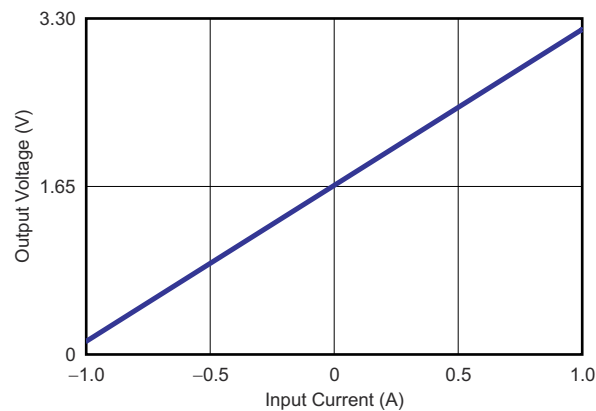

Figure 9-2. Bidirectional Current-Sensing Circuit Performance: Output Voltage vs Input Current

9.3 Power Supply Recommendations

The OPAx392 are specified for operation from 1.7 V to 5.5 V (± 0.85 V to ± 2.75 V).

CAUTION

Exceeding supply voltages listed in the *Absolute Maximum Ratings* table can permanently damage the device.

9.4 Layout

9.4.1 Layout Guidelines

Pay attention to good layout practice. Keep traces short, and when possible, use a printed-circuit board (PCB) ground plane with surface-mount components placed as close to the device pins as possible. Place a 0.1- μ F capacitor closely across the supply pins. These guidelines must be applied throughout the analog circuit to improve performance and provide benefits such as reducing the electromagnetic interference (EMI) susceptibility.

For lowest offset voltage and precision performance, circuit layout and mechanical conditions must be optimized. Avoid temperature gradients that create thermoelectric (Seebeck) effects in the thermocouple junctions formed from connecting dissimilar conductors. These thermally-generated potentials can be made to cancel by making sure these potentials are equal on both input terminals. Other layout and design considerations include:

- Use low thermoelectric-coefficient conditions (avoid dissimilar metals).
- Use guard traces to minimize leakage current when ultra-low bias current is required.
- Thermally isolate components from power supplies or other heat sources.
- Shield operational amplifier and input circuitry from air currents, such as cooling fans.

Following these guidelines reduces the likelihood of junctions being at different temperatures, which can cause thermoelectric voltage drift of 0.1 μ V/ $^{\circ}$ C or higher, depending on materials used.

9.4.2 Layout Example

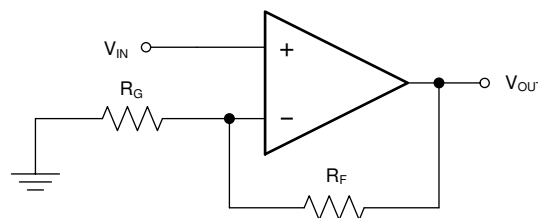

Figure 9-3. OPA392 Layout Schematic

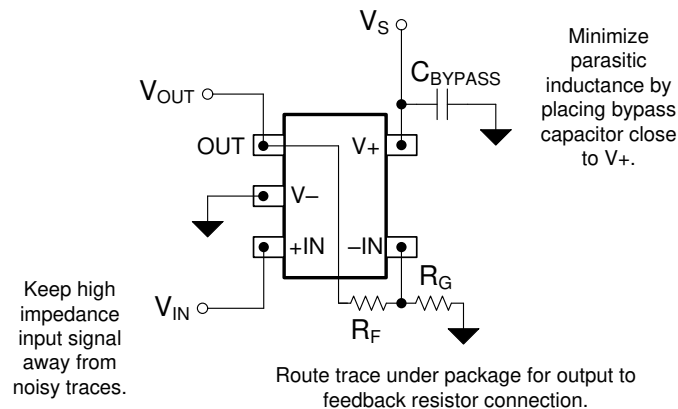

Figure 9-4. OPA392 Layout Example

10 Device and Documentation Support

10.1 Device Support

10.1.1 Development Support

10.1.1.1 PSpice® for TI

PSpice® for TI is a design and simulation environment that helps evaluate performance of analog circuits. Create subsystem designs and prototype solutions before committing to layout and fabrication, reducing development cost and time to market.

10.1.1.2 TINA-TI™ Simulation Software (Free Download)

TINA-TI™ simulation software is a simple, powerful, and easy-to-use circuit simulation program based on a SPICE engine. TINA-TI simulation software is a free, fully-functional version of the TINA™ software, preloaded with a library of macromodels, in addition to a range of both passive and active models. TINA-TI simulation software provides all the conventional dc, transient, and frequency domain analysis of SPICE, as well as additional design capabilities.

Available as a [free download](#) from the [Design tools and simulation](#) web page, TINA-TI simulation software offers extensive post-processing capability that allows users to format results in a variety of ways. Virtual instruments offer the ability to select input waveforms and probe circuit nodes, voltages, and waveforms, creating a dynamic quick-start tool.

Note

These files require that either the TINA software or TINA-TI software be installed. Download the free TINA-TI simulation software from the [TINA-TI™ software folder](#).

10.2 Documentation Support

10.2.1 Related Documentation

For related documentation see the following:

- Texas Instruments, [Amplifier Input Common-Mode and Output-Swing Limitations application note](#)
- Texas Instruments, [Offset Correction Methods: Laser Trim, e-Trim™, and Chopper application brief](#)

10.3 Receiving Notification of Documentation Updates

To receive notification of documentation updates, navigate to the device product folder on [ti.com](#). Click on [Subscribe to updates](#) to register and receive a weekly digest of any product information that has changed. For change details, review the revision history included in any revised document.

10.4 Support Resources

[TI E2E™ support forums](#) are an engineer's go-to source for fast, verified answers and design help — straight from the experts. Search existing answers or ask your own question to get the quick design help you need.

Linked content is provided "AS IS" by the respective contributors. They do not constitute TI specifications and do not necessarily reflect TI's views; see TI's [Terms of Use](#).

10.5 Trademarks

e-trim™, TINA-TI™, and TI E2E™ are trademarks of Texas Instruments.

TINA™ is a trademark of DesignSoft, Inc.

PSpice® is a registered trademark of Cadence Design Systems, Inc.

All trademarks are the property of their respective owners.

10.6 Electrostatic Discharge Caution



This integrated circuit can be damaged by ESD. Texas Instruments recommends that all integrated circuits be handled with appropriate precautions. Failure to observe proper handling and installation procedures can cause damage.

ESD damage can range from subtle performance degradation to complete device failure. Precision integrated circuits may be more susceptible to damage because very small parametric changes could cause the device not to meet its published specifications.

10.7 Glossary

[TI Glossary](#) This glossary lists and explains terms, acronyms, and definitions.

11 Mechanical, Packaging, and Orderable Information

The following pages include mechanical packaging and orderable information. This information is the most current data available for the designated devices. This data is subject to change without notice and revision of this document. For browser-based versions of this data sheet, refer to the left-hand navigation.

PACKAGING INFORMATION

Orderable Device	Status (1)	Package Type	Package Drawing	Pins	Package Qty	Eco Plan (2)	Lead finish/ Ball material (6)	MSL Peak Temp (3)	Op Temp (°C)	Device Marking (4/5)	Samples
OPA2392YBJR	ACTIVE	DSBGA	YBJ	9	3000	RoHS & Green	SNAGCU	Level-1-260C-UNLIM	-40 to 125	O23	Samples
OPA2392YBJT	ACTIVE	DSBGA	YBJ	9	250	RoHS & Green	SNAGCU	Level-1-260C-UNLIM	-40 to 125	O23	Samples
OPA392DBVR	ACTIVE	SOT-23	DBV	5	3000	RoHS & Green	NIPDAU	Level-1-260C-UNLIM	-40 to 125	23GT	Samples
OPA392DBVT	ACTIVE	SOT-23	DBV	5	250	RoHS & Green	NIPDAU	Level-1-260C-UNLIM	-40 to 125	23GT	Samples

(1) The marketing status values are defined as follows:

ACTIVE: Product device recommended for new designs.

LIFEBUY: TI has announced that the device will be discontinued, and a lifetime-buy period is in effect.

NRND: Not recommended for new designs. Device is in production to support existing customers, but TI does not recommend using this part in a new design.

PREVIEW: Device has been announced but is not in production. Samples may or may not be available.

OBSELETE: TI has discontinued the production of the device.

(2) **RoHS:** TI defines "RoHS" to mean semiconductor products that are compliant with the current EU RoHS requirements for all 10 RoHS substances, including the requirement that RoHS substance do not exceed 0.1% by weight in homogeneous materials. Where designed to be soldered at high temperatures, "RoHS" products are suitable for use in specified lead-free processes. TI may reference these types of products as "Pb-Free".

RoHS Exempt: TI defines "RoHS Exempt" to mean products that contain lead but are compliant with EU RoHS pursuant to a specific EU RoHS exemption.

Green: TI defines "Green" to mean the content of Chlorine (Cl) and Bromine (Br) based flame retardants meet JS709B low halogen requirements of <=1000ppm threshold. Antimony trioxide based flame retardants must also meet the <=1000ppm threshold requirement.

(3) MSL, Peak Temp. - The Moisture Sensitivity Level rating according to the JEDEC industry standard classifications, and peak solder temperature.

(4) There may be additional marking, which relates to the logo, the lot trace code information, or the environmental category on the device.

(5) Multiple Device Markings will be inside parentheses. Only one Device Marking contained in parentheses and separated by a "-" will appear on a device. If a line is indented then it is a continuation of the previous line and the two combined represent the entire Device Marking for that device.

(6) Lead finish/Ball material - Orderable Devices may have multiple material finish options. Finish options are separated by a vertical ruled line. Lead finish/Ball material values may wrap to two lines if the finish value exceeds the maximum column width.

Important Information and Disclaimer:The information provided on this page represents TI's knowledge and belief as of the date that it is provided. TI bases its knowledge and belief on information provided by third parties, and makes no representation or warranty as to the accuracy of such information. Efforts are underway to better integrate information from third parties. TI has taken and

continues to take reasonable steps to provide representative and accurate information but may not have conducted destructive testing or chemical analysis on incoming materials and chemicals. TI and TI suppliers consider certain information to be proprietary, and thus CAS numbers and other limited information may not be available for release.

In no event shall TI's liability arising out of such information exceed the total purchase price of the TI part(s) at issue in this document sold by TI to Customer on an annual basis.

TAPE AND REEL INFORMATION

QUADRANT ASSIGNMENTS FOR PIN 1 ORIENTATION IN TAPE

*All dimensions are nominal

Device	Package Type	Package Drawing	Pins	SPQ	Reel Diameter (mm)	Reel Width W1 (mm)	A0 (mm)	B0 (mm)	K0 (mm)	P1 (mm)	W (mm)	Pin1 Quadrant
OPA2392YBJR	DSBGA	YBJ	9	3000	180.0	8.4	1.26	1.26	0.43	4.0	8.0	Q1
OPA2392YBJT	DSBGA	YBJ	9	250	180.0	8.4	1.26	1.26	0.43	4.0	8.0	Q1
OPA392DBVR	SOT-23	DBV	5	3000	178.0	9.0	3.3	3.2	1.4	4.0	8.0	Q3
OPA392DBVT	SOT-23	DBV	5	250	178.0	9.0	3.3	3.2	1.4	4.0	8.0	Q3

TAPE AND REEL BOX DIMENSIONS

*All dimensions are nominal

Device	Package Type	Package Drawing	Pins	SPQ	Length (mm)	Width (mm)	Height (mm)
OPA2392YBJR	DSBGA	YBJ	9	3000	182.0	182.0	20.0
OPA2392YBJT	DSBGA	YBJ	9	250	182.0	182.0	20.0
OPA392DBVR	SOT-23	DBV	5	3000	180.0	180.0	18.0
OPA392DBVT	SOT-23	DBV	5	250	180.0	180.0	18.0

EXAMPLE BOARD LAYOUT

DBV0005A

SOT-23 - 1.45 mm max height

SMALL OUTLINE TRANSISTOR



LAND PATTERN EXAMPLE
EXPOSED METAL SHOWN
SCALE:15X

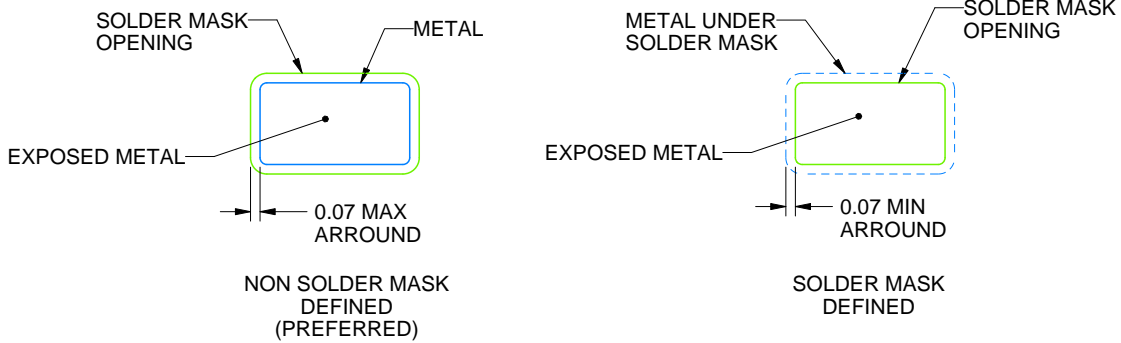

SOLDER MASK DETAILS

4214839/F 06/2021

NOTES: (continued)

- 5. Publication IPC-7351 may have alternate designs.
- 6. Solder mask tolerances between and around signal pads can vary based on board fabrication site.

EXAMPLE STENCIL DESIGN

DBV0005A

SOT-23 - 1.45 mm max height

SMALL OUTLINE TRANSISTOR



SOLDER PASTE EXAMPLE
BASED ON 0.125 mm THICK STENCIL
SCALE:15X

4214839/F 06/2021

NOTES: (continued)

7. Laser cutting apertures with trapezoidal walls and rounded corners may offer better paste release. IPC-7525 may have alternate design recommendations.
8. Board assembly site may have different recommendations for stencil design.

YBJ0009

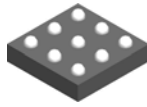

PACKAGE OUTLINE

DSBGA - 0.35 mm max height

DIE SIZE BALL GRID ARRAY

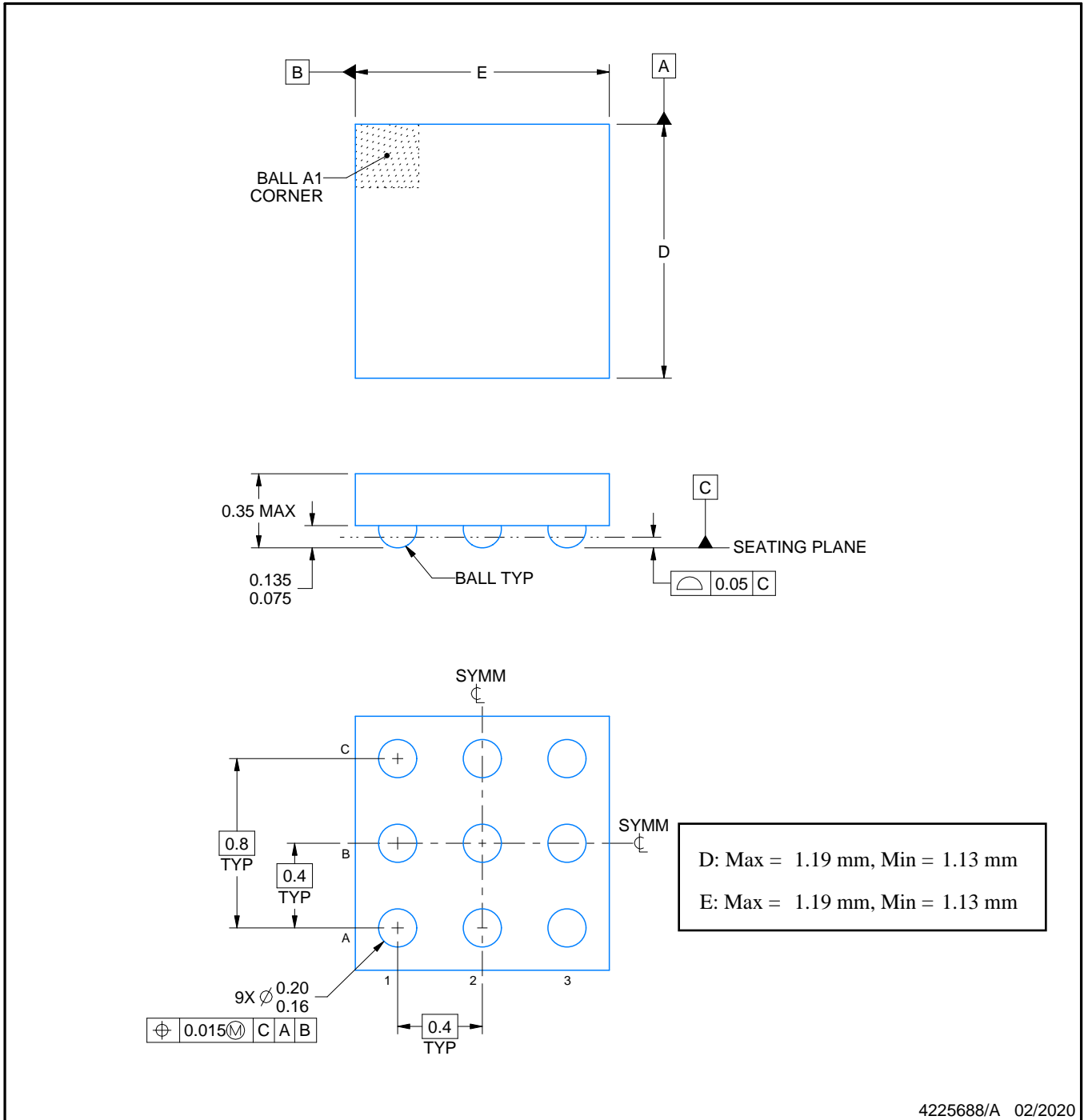

NOTES:

1. All linear dimensions are in millimeters. Any dimensions in parenthesis are for reference only. Dimensioning and tolerancing per ASME Y14.5M.
2. This drawing is subject to change without notice.

EXAMPLE BOARD LAYOUT

YBJ0009

DSBGA - 0.35 mm max height

DIE SIZE BALL GRID ARRAY

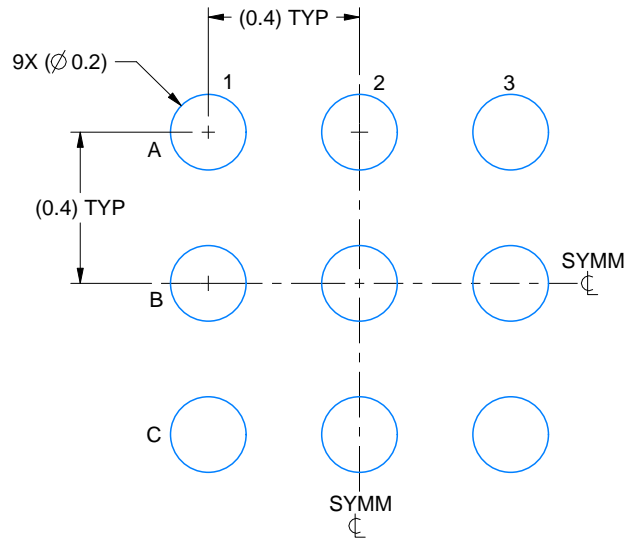

LAND PATTERN EXAMPLE
EXPOSED METAL SHOWN
SCALE: 50X

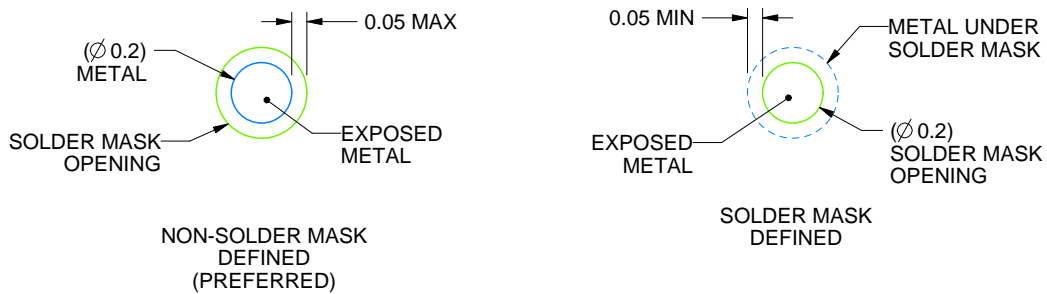

SOLDER MASK DETAILS
NOT TO SCALE

4225688/A 02/2020

NOTES: (continued)

- Final dimensions may vary due to manufacturing tolerance considerations and also routing constraints. See Texas Instruments Literature No. SNVA009 (www.ti.com/lit/snva009).

EXAMPLE STENCIL DESIGN

YBJ0009

DSBGA - 0.35 mm max height

DIE SIZE BALL GRID ARRAY

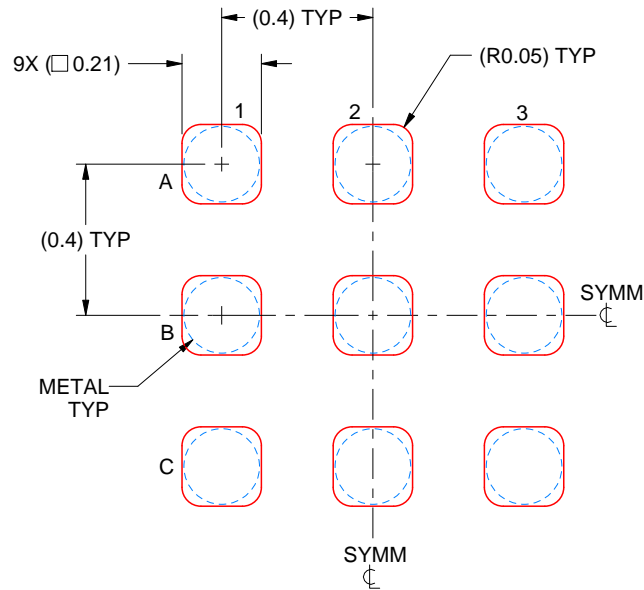

SOLDER PASTE EXAMPLE
BASED ON 0.1 mm THICK STENCIL
SCALE: 50X

4225688/A 02/2020

NOTES: (continued)

4. Laser cutting apertures with trapezoidal walls and rounded corners may offer better paste release.

IMPORTANT NOTICE AND DISCLAIMER

TI PROVIDES TECHNICAL AND RELIABILITY DATA (INCLUDING DATA SHEETS), DESIGN RESOURCES (INCLUDING REFERENCE DESIGNS), APPLICATION OR OTHER DESIGN ADVICE, WEB TOOLS, SAFETY INFORMATION, AND OTHER RESOURCES "AS IS" AND WITH ALL FAULTS, AND DISCLAIMS ALL WARRANTIES, EXPRESS AND IMPLIED, INCLUDING WITHOUT LIMITATION ANY IMPLIED WARRANTIES OF MERCHANTABILITY, FITNESS FOR A PARTICULAR PURPOSE OR NON-INFRINGEMENT OF THIRD PARTY INTELLECTUAL PROPERTY RIGHTS.

These resources are intended for skilled developers designing with TI products. You are solely responsible for (1) selecting the appropriate TI products for your application, (2) designing, validating and testing your application, and (3) ensuring your application meets applicable standards, and any other safety, security, regulatory or other requirements.

These resources are subject to change without notice. TI grants you permission to use these resources only for development of an application that uses the TI products described in the resource. Other reproduction and display of these resources is prohibited. No license is granted to any other TI intellectual property right or to any third party intellectual property right. TI disclaims responsibility for, and you will fully indemnify TI and its representatives against, any claims, damages, costs, losses, and liabilities arising out of your use of these resources.

TI's products are provided subject to [TI's Terms of Sale](#) or other applicable terms available either on [ti.com](https://www.ti.com) or provided in conjunction with such TI products. TI's provision of these resources does not expand or otherwise alter TI's applicable warranties or warranty disclaimers for TI products.

TI objects to and rejects any additional or different terms you may have proposed.

Mailing Address: Texas Instruments, Post Office Box 655303, Dallas, Texas 75265
Copyright © 2023, Texas Instruments Incorporated