

**NOT RECOMMENDED FOR NEW DESIGNS
RECOMMENDED REPLACEMENT PART
ISL28233FUZ**

ISL28233I

Dual Micropower, Zero-Drift, RRIO Operational Amplifiers

ISL28233I

The ISL28233IUZ is a dual micropower, zero-drift operational amplifier that is optimized for single and dual supply operation from 1.65V to 5.5V and $\pm 0.825V$ to $\pm 2.75V$. The low supply current of $18\mu A$ and wide input range enable the ISL28233IUZ to be an excellent general purpose op amp for a range of applications. The ISL28233IUZ is ideal for handheld devices that operate off 2 AA or single Li-ion batteries.

The ISL28233IUZ is available in an industry standard pinout 8 Ld MSOP package. It operates over the temperature range of $-40^{\circ}C$ to $+85^{\circ}C$.

Features

- Low Input Offset Voltage $8\mu V$, Max.
- Low Offset Drift $0.06\mu V/^{\circ}C$, Max
- Quiescent Current (Per Amplifier) $18\mu A$, Typ.
- Single Supply Range $+1.65V$ to $+5.5V$
- Dual Supply Range $\pm 0.825V$ to $\pm 2.75V$
- Low Noise (0.01Hz to 10Hz) $1.1\mu V_{p-p}$, Typ.
- Rail-to-Rail Inputs and Output
- Input Bias Current $110pA$, Max.
- Operating Temperature Range $-40^{\circ}C$ to $+85^{\circ}C$

Applications

- Bi-Directional Current Sense
- Temperature Measurement
- Medical Equipment
- Electronic Weigh Scales
- Precision/Strain Gauge Sensor
- Precision Regulation
- Low Ohmic Current Sense
- High Gain Analog Front Ends

Typical Application

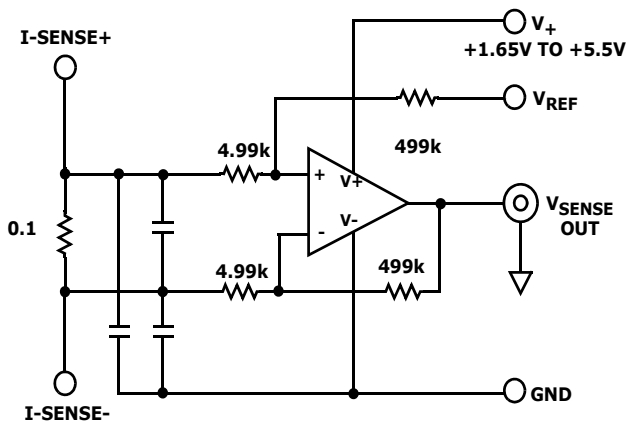

BI-DIRECTIONAL CURRENT SENSE AMPLIFIER

V_{OS} vs TEMP

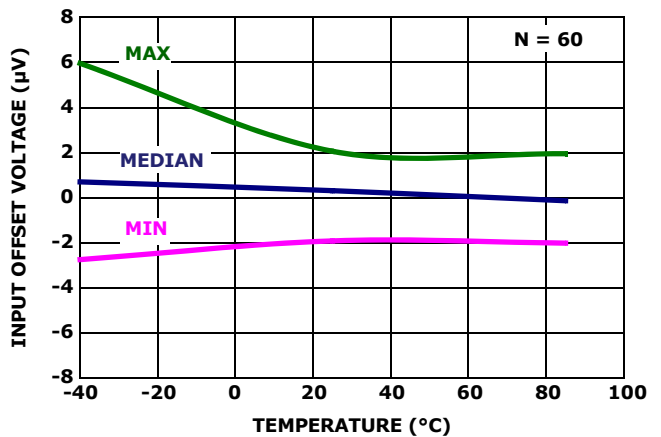

Ordering Information

PART NUMBER (Note 3)	PART MARKING	PACKAGE (Pb-Free)	PKG. DWG. #
ISL28233IUZ (Note 2)	8233Z	8 Ld MSOP	M8.118A
ISL28233IUZ-T7 (Notes 1, 2)	8233Z	8 Ld MSOP	M8.118A

NOTES:

1. Please refer to [TB347](#) for details on reel specifications.
2. These Intersil Pb-free plastic packaged products employ special Pb-free material sets, molding compounds/die attach materials, and 100% matte tin plate plus anneal (e3 termination finish, which is RoHS compliant and compatible with both SnPb and Pb-free soldering operations). Intersil Pb-free products are MSL classified at Pb-free peak reflow temperatures that meet or exceed the Pb-free requirements of IPC/JEDEC J STD-020.
3. For Moisture Sensitivity Level (MSL), please see device information page for [ISL28233I](#). For more information on MSL please see techbrief [TB363](#).

ISL28233I

Pin Configurations

ISL28233IUZ
(8 LD MSOP)
TOP VIEW

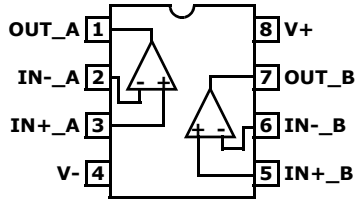

Pin Descriptions

ISL28233IUZ (8 Ld MSOP)	PIN NAME	FUNCTION	EQUIVALENT CIRCUIT
3	IN+_A	Non-inverting input	<p>Circuit 1</p>
5	IN+_B		
	IN+_C		
	IN+_D		
4	V-	Negative supply	
2	IN-_A	Inverting input	(See Circuit 1)
6	IN-_B		
	IN-_C		
	IN-_D		
1	OUT_A	Output	<p>Circuit 2</p>
7	OUT_B		
	OUT_C		
	OUT_D		
8	V+	Positive supply	

ISL28233I

Absolute Maximum Ratings

Max Supply Voltage V+ to V-	6.5V
Max Voltage VIN to GND (V- - 0.3V) to (V+ + 0.3V)V	
Max Input Differential Voltage	6.5V
Max Input Current	20mA
Max Voltage VOVT to GND (10s)	±3.0V
ESD Tolerance	
Human Body Model	4000V
Machine Model	400V
Charged Device Model	2000V
Latch-Up Passed Per JESD78B	+125°C

Thermal Information

Thermal Resistance (Typical)	θ_{JA} (°C/W)	θ_{JC} (°C/W)
8 Ld MSOP (Notes 4, 5)	180	65
Maximum Storage Temperature Range . . .	-65°C to +150°C	
Pb-Free Reflow Profile	see link below	
	http://www.intersil.com/pbfree/Pb-FreeReflow.asp	

Operating Conditions

Temperature Range	-40°C to +85°C
-----------------------------	----------------

CAUTION: Do not operate at or near the maximum ratings listed for extended periods of time. Exposure to such conditions may adversely impact product reliability and result in failures not covered by warranty.

NOTES:

- θ_{JA} is measured with the component mounted on a high effective thermal conductivity test board in free air. See Tech Brief TB379 for details.
- For θ_{JC} , the "case temp" location is taken at the package top center.

Electrical Specifications

$V_+ = 5V$, $V_- = 0V$, $V_{CM} = 2.5V$, $T_A = +25^\circ C$, $R_L = 10k\Omega$, unless otherwise specified.
Boldface limits apply over the operating temperature range, -40°C to +85°C.

PARAMETER	DESCRIPTION	CONDITIONS	MIN (Note 6)	TYP	MAX (Note 6)	UNIT
DC SPECIFICATIONS						
V _{OS}	Input Offset Voltage		-8	±2	8	μV
			-11.9	-	11.9	μV
TCV _{OS}	Input Offset Voltage Temperature Coefficient		-0.06	0.02	0.06	μV/°C
I _{OS}	Input Offset Current		-	1	-	pA
TCI _{OS}	Input Offset Current Temperature Coefficient		-	0.11	-	pA/°C
I _B	Input Bias Current		-110	±30	110	pA
			-110	-	110	pA
TCI _B	Input Bias Current Temperature Coefficient		-	0.49	-	pA/°C
Common Mode Input Voltage Range		V ₊ = 5.0V, V ₋ = GND	-0.1	-	5.1	V
CMRR	Common Mode Rejection Ratio	V _{CM} = -0.1V to 5.1V	118	125	-	dB
			115		-	dB
PSRR	Power Supply Rejection Ratio	V _S = 1.65V to 5.5V	110	138	-	dB
			110		-	dB
V _{OH}	Output Voltage Swing, High	R _L = 10kΩ	4.965	4.981	-	V
V _{OL}	Output Voltage Swing, Low			18	35	mV
A _{OL}	Open Loop Gain	R _L = 1MΩ		174	-	dB
V ₊	Supply Voltage	Guaranteed by PSRR	1.65	-	5.5	V
I _S	Supply Current, Per Amplifier	R _L = OPEN	-	18	25	μA
			-	-	35	μA
I _{SC+}	Output Source Short Circuit Current	R _L = Short to ground or V ₊	13	17	26	mA
I _{SC-}	Output Sink Short Circuit Current		-26	-19	-13	mA

ISL28233I

Electrical Specifications $V_+ = 5V, V_- = 0V, V_{CM} = 2.5V, T_A = +25^\circ C, R_L = 10k\Omega$, unless otherwise specified.
Boldface limits apply over the operating temperature range, -40°C to +85°C. (Continued)

PARAMETER	DESCRIPTION	CONDITIONS	MIN (Note 6)	TYP	MAX (Note 6)	UNIT
AC SPECIFICATIONS						
GBWP	Gain Bandwidth Product $f = 50kHz$	$A_V = 100, R_F = 100k\Omega,$ $R_G = 1k\Omega, R_L = 10k\Omega$ to V_{CM}	-	400	-	kHz
$e_N V_{p-p}$	Peak-to-Peak Input Noise Voltage	$f = 0.01Hz$ to $10Hz$	-	1.1	-	μV_{p-p}
e_N	Input Noise Voltage Density	$f = 1kHz$	-	65	-	$nV/\sqrt{(Hz)}$
i_N	Input Noise Current Density	$f = 1kHz$	-	72	-	$fA/\sqrt{(Hz)}$
		$f = 10Hz$	-	79	-	$fA/\sqrt{(Hz)}$
C_{in}	Differential Input Capacitance	$f = 1MHz$	-	1.6	-	pF
	Common Mode Input Capacitance		-	1.12	-	pF
TRANSIENT RESPONSE						
SR	Positive Slew Rate	$V_{OUT} = 1V$ to $4V, R_L = 10k\Omega$	-	0.2	-	$V/\mu s$
	Negative Slew Rate		-	0.1	-	$V/\mu s$
t_r, t_f Small Signal	Rise Time, t_r 10% to 90%	$A_V = +1, V_{OUT} = 0.1V_{p-p},$ $R_F = 0\Omega, R_L = 10k\Omega,$ $C_L = 1.2pF$	-	1.1	-	μs
	Fall Time, t_f 10% to 90%		-	1.1	-	μs
t_r, t_f Large Signal	Rise Time, t_r 10% to 90%	$A_V = +1, V_{OUT} = 2V_{p-p},$ $R_F = 0\Omega, R_L = 10k\Omega,$ $C_L = 1.2pF$	-	8	-	μs
	Fall Time, t_f 10% to 90%		-	10	-	μs
t_s	Settling Time to 0.1%, $2V_{p-p}$ Step	$A_V = +1, R_F = 0\Omega,$ $R_L = 10k\Omega, C_L = 1.2pF$	-	35	-	μs
$t_{recover}$	Output Overload Recovery Time, Recovery to 90% of output saturation	$A_V = +2, R_F = 10k\Omega,$ $R_L = Open, C_L = 3.7pF$	-	10.5	-	μs

NOTE:

- Parameters with MIN and/or MAX limits are 100% tested at +25°C, unless otherwise specified. Temperature limits established by characterization and are not production tested.

Typical Performance Curves

$V_+ = 5V$, $V_- = 0V$, $V_{CM} = 2.5V$, $R_L = \text{Open}$, $T = +25^\circ\text{C}$, unless otherwise specified.

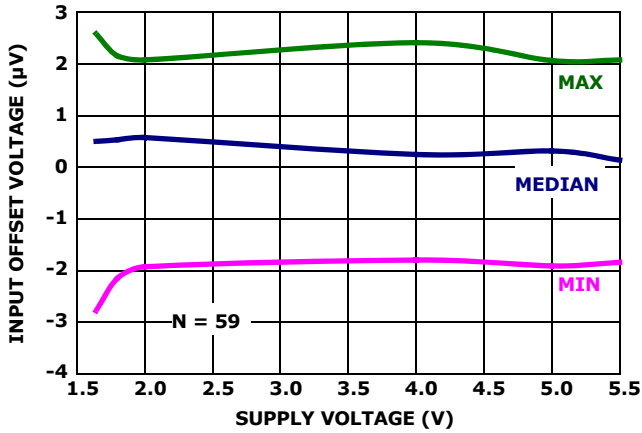

FIGURE 1. INPUT OFFSET VOLTAGE vs SUPPLY VOLTAGE

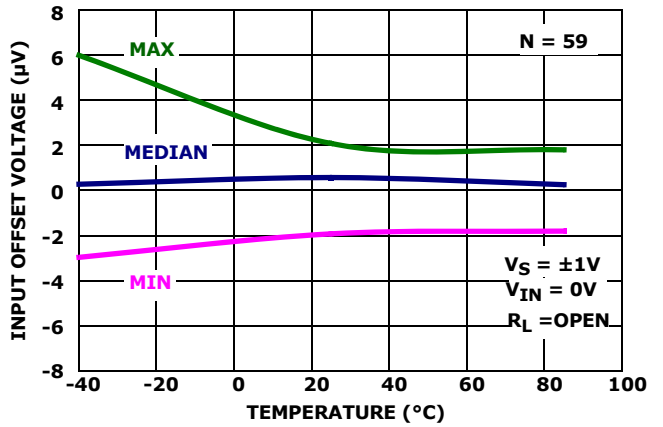

FIGURE 2. V_{OS} vs TEMPERATURE

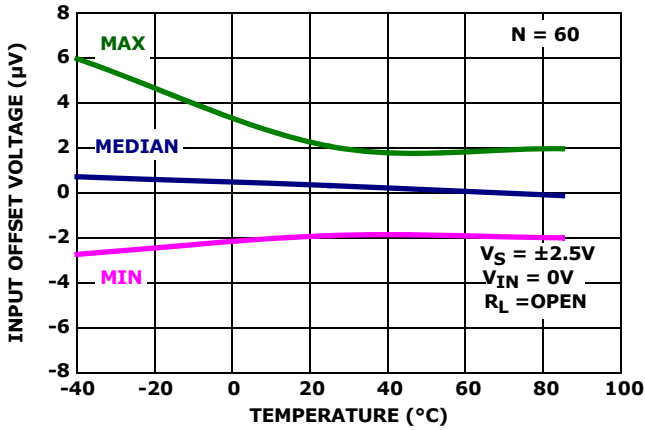

FIGURE 3. V_{OS} vs TEMPERATURE

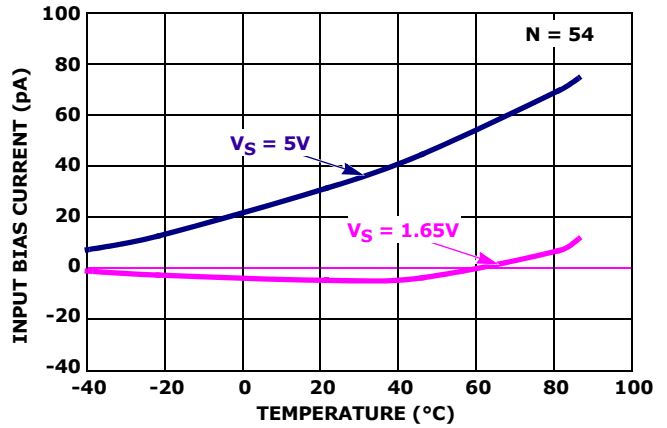

FIGURE 4. MEDIAN I_{B+} vs TEMPERATURE

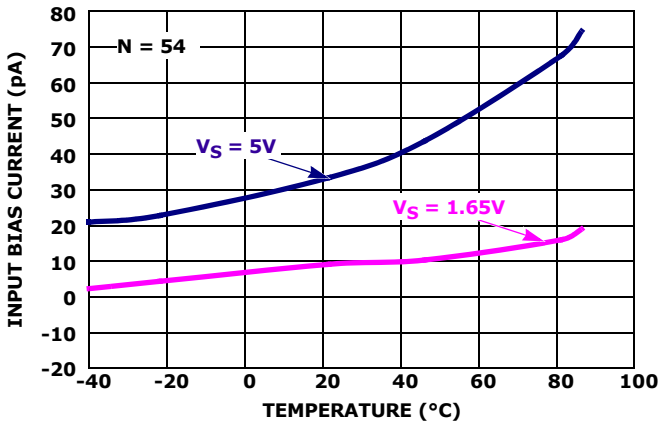

FIGURE 5. MEDIAN I_{B-} vs TEMPERATURE

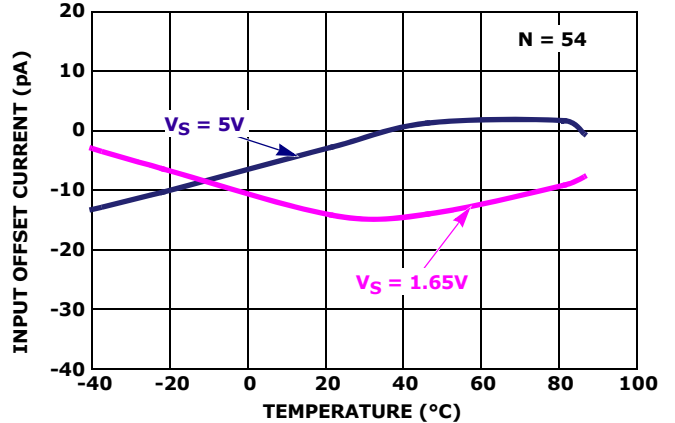

FIGURE 6. MEDIAN I_{OS} vs SUPPLY VOLTAGE vs TEMPERATURE

Typical Performance Curves

$V_+ = 5V$, $V_- = 0V$, $V_{CM} = 2.5V$, $R_L = \text{Open}$, $T = +25^\circ\text{C}$, unless otherwise specified. (Continued)

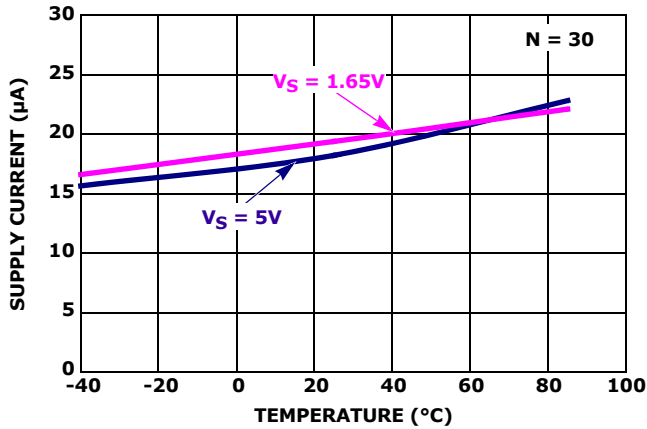

FIGURE 7. MEDIAN SUPPLY CURRENT vs TEMPERATURE vs SUPPLY VOLTAGE

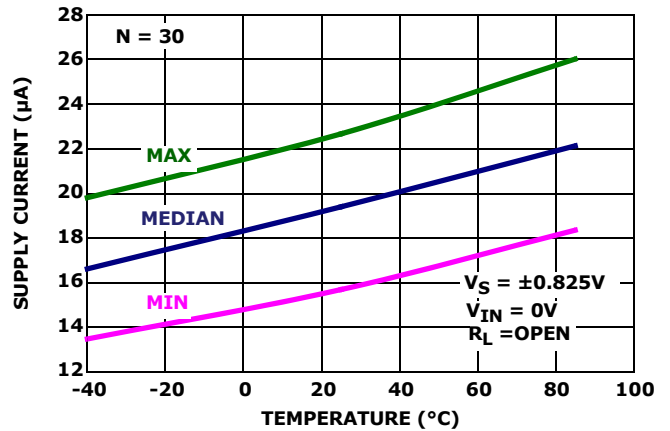

FIGURE 8. SUPPLY CURRENT vs TEMPERATURE

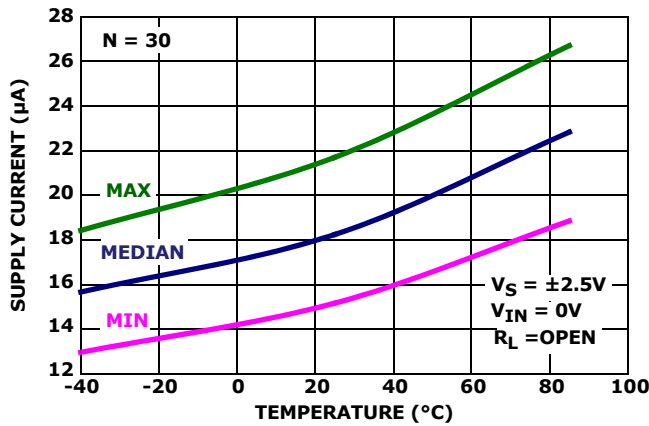

FIGURE 9. SUPPLY CURRENT vs TEMPERATURE

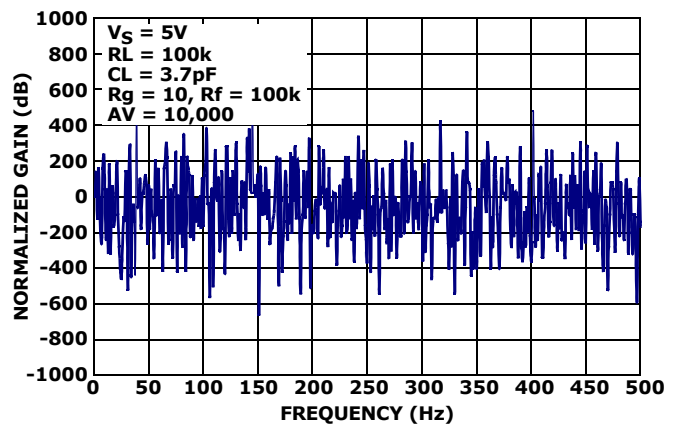

FIGURE 10. INPUT NOISE VOLTAGE 0.1Hz TO 10Hz

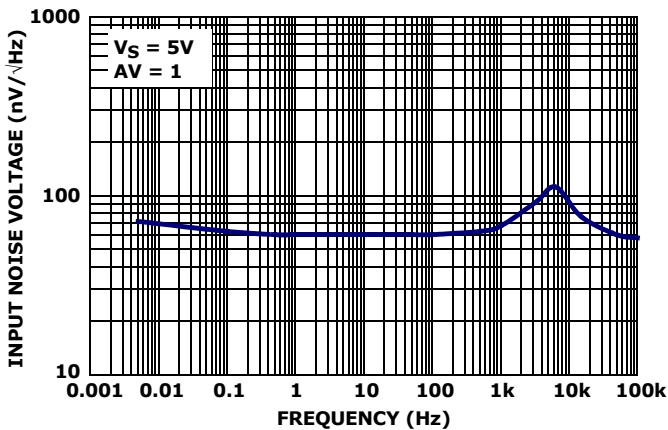

FIGURE 11. INPUT NOISE VOLTAGE DENSITY vs FREQUENCY

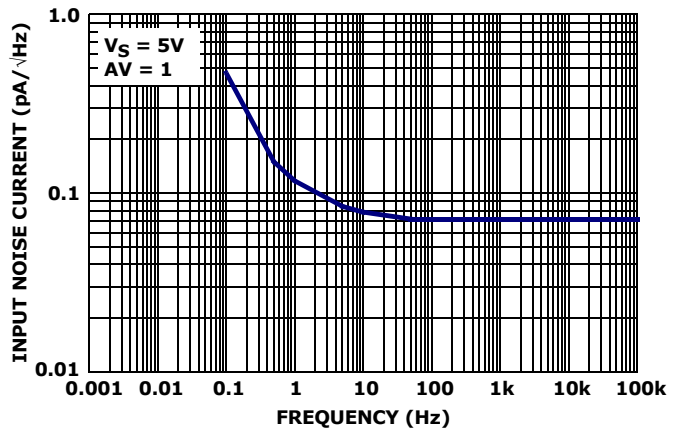

FIGURE 12. INPUT NOISE CURRENT DENSITY vs FREQUENCY

Typical Performance Curves

$V_+ = 5V, V_- = 0V, V_{CM} = 2.5V, R_L = \text{Open}, T = +25^\circ\text{C}$, unless otherwise specified. (Continued)

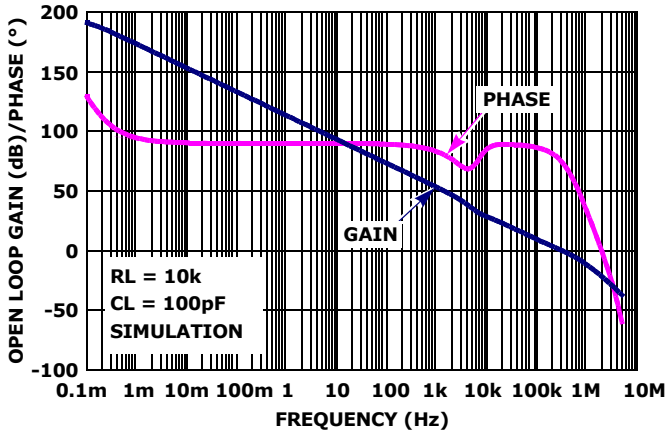

FIGURE 13. FREQUENCY RESPONSE vs OPEN LOOP GAIN, $R_L = 10k\Omega$

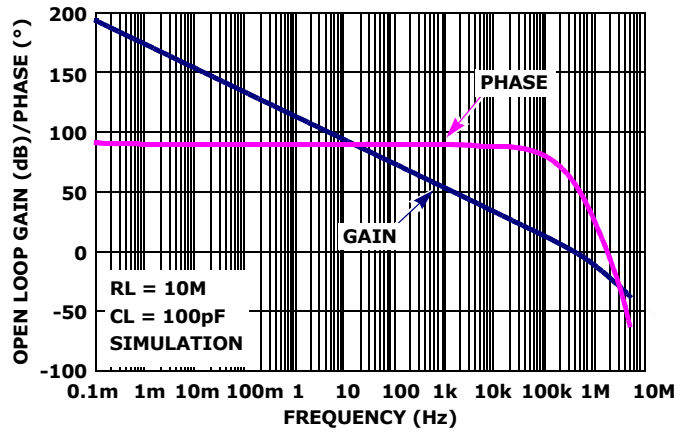

FIGURE 14. FREQUENCY RESPONSE vs OPEN LOOP GAIN, $R_L = 10M\Omega$

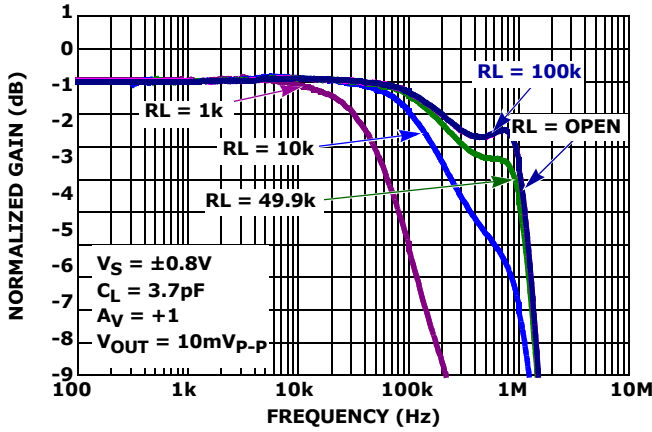

FIGURE 15. GAIN vs FREQUENCY vs $R_L, V_S = \pm 0.8V$

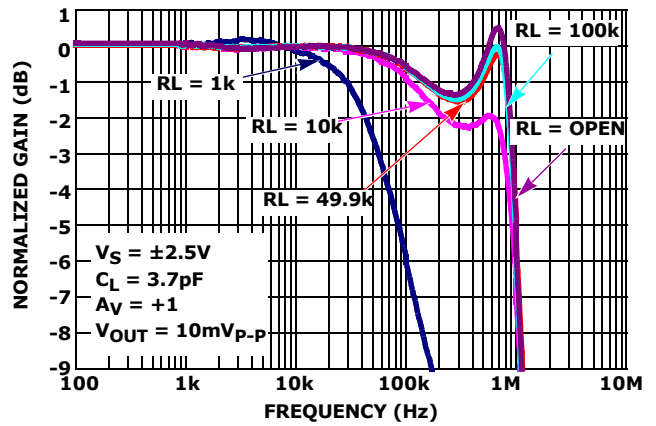

FIGURE 16. GAIN vs FREQUENCY vs $R_L, V_S = \pm 2.5V$

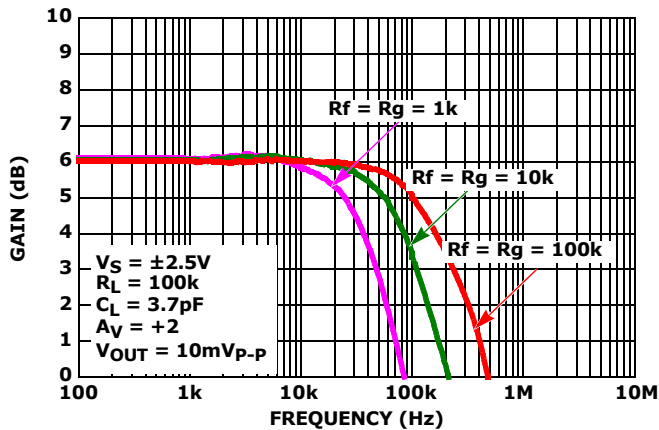

FIGURE 17. GAIN vs FREQUENCY vs FEEDBACK RESISTOR VALUES R_f/R_g

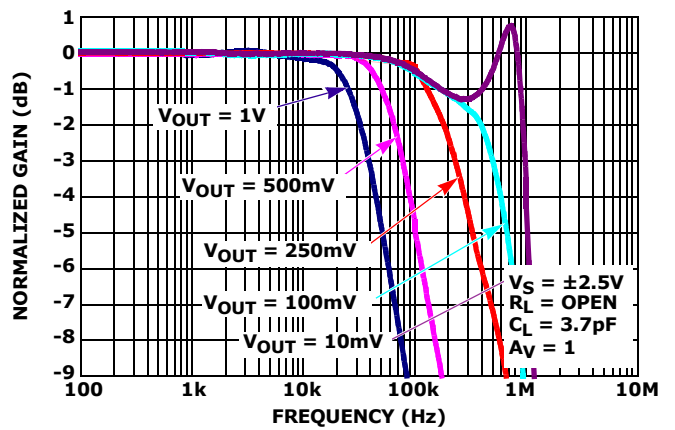

FIGURE 18. GAIN vs FREQUENCY vs $V_{OUT}, R_L = \text{OPEN}$

Typical Performance Curves

$V_+ = 5V$, $V_- = 0V$, $V_{CM} = 2.5V$, $R_L = \text{Open}$, $T = +25^\circ\text{C}$, unless otherwise specified. (Continued)

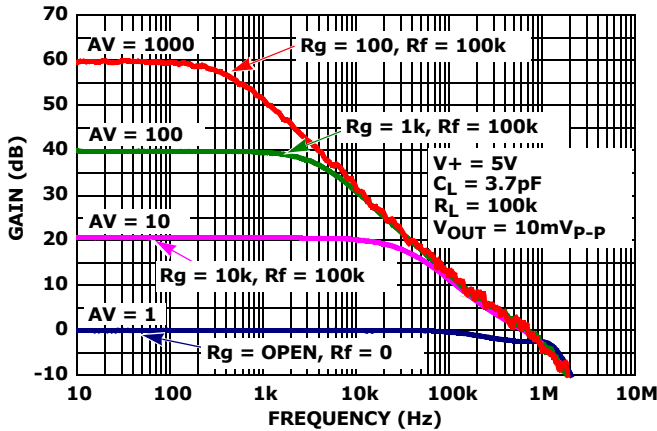

FIGURE 19. FREQUENCY RESPONSE vs CLOSED LOOP GAIN

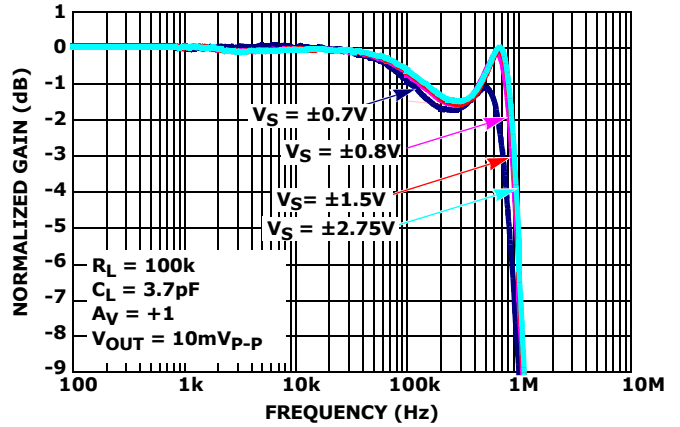

FIGURE 20. GAIN vs FREQUENCY vs SUPPLY VOLTAGE

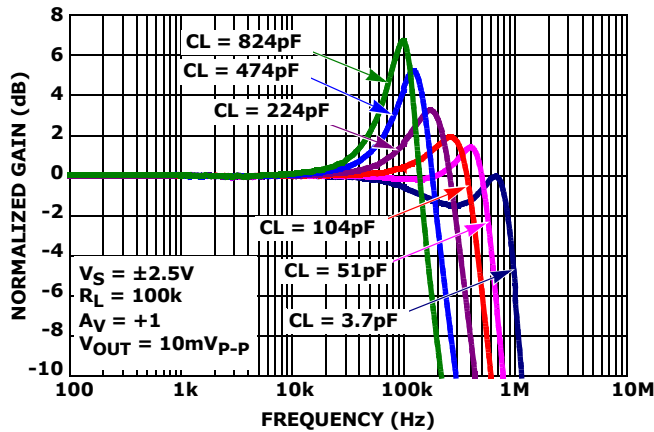

FIGURE 21. GAIN vs FREQUENCY vs C_L

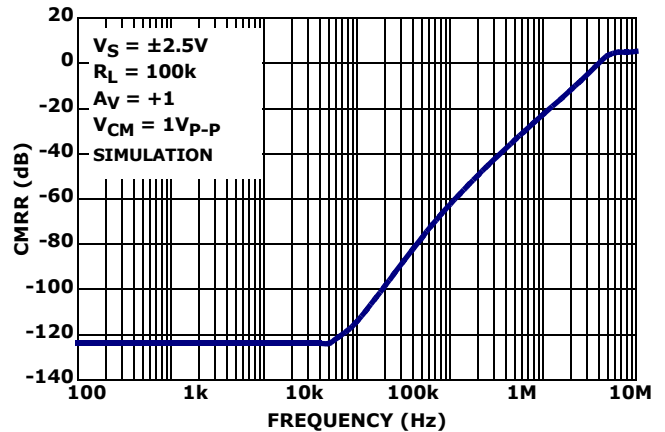

FIGURE 22. CMRR vs FREQUENCY, $V_S = \pm 2.5V$

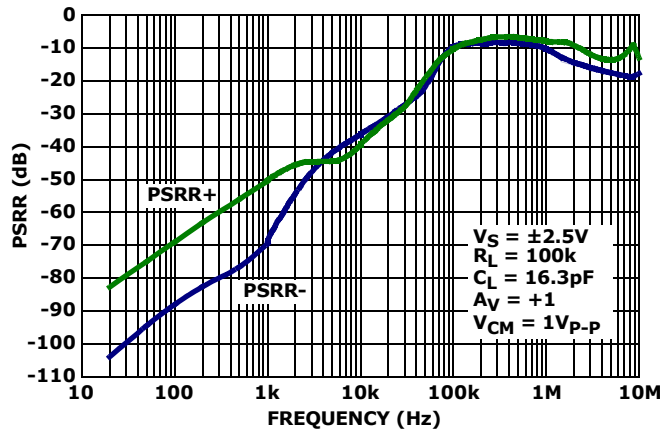

FIGURE 23. PSRR vs FREQUENCY, $V_S = \pm 2.5V$

Typical Performance Curves

$V_+ = 5V$, $V_- = 0V$, $V_{CM} = 2.5V$, $R_L = \text{Open}$, $T = +25^\circ\text{C}$, unless otherwise specified. (Continued)

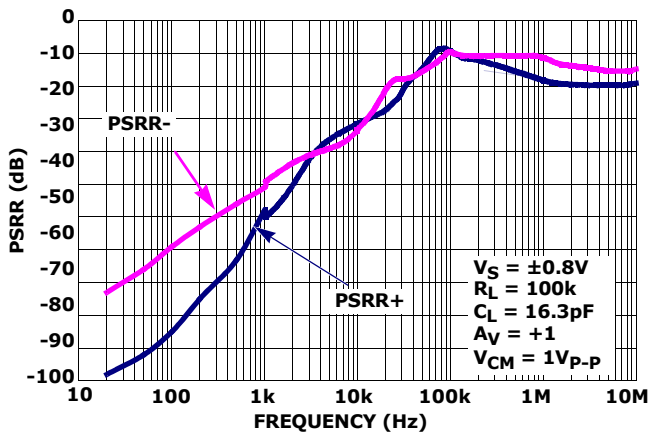

FIGURE 24. PSRR vs FREQUENCY, $V_S = \pm 0.8V$

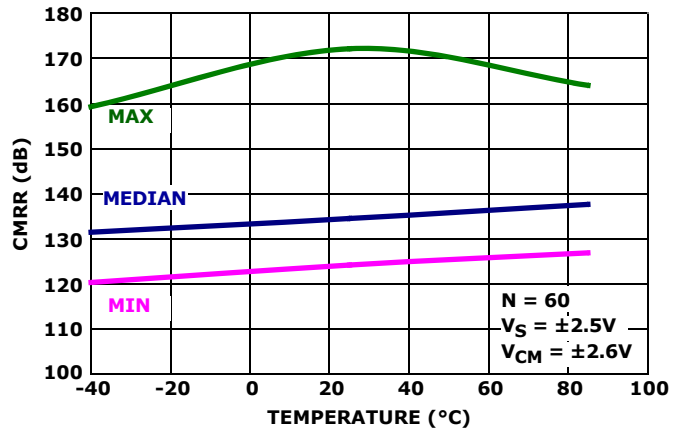

FIGURE 25. CMRR vs TEMPERATURE

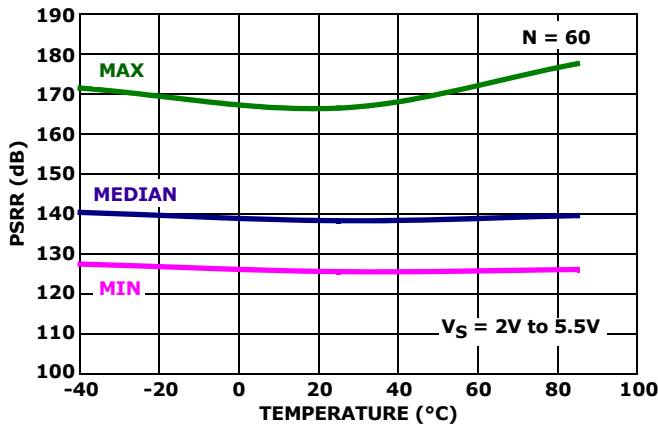

FIGURE 26. PSRR vs TEMPERATURE

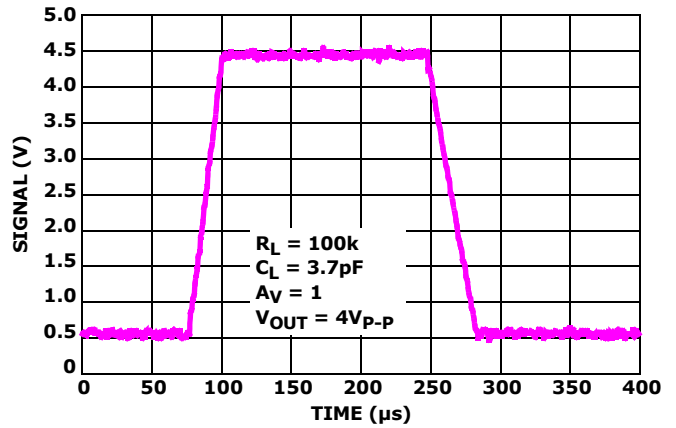

FIGURE 27. LARGE SIGNAL STEP RESPONSE (4V)

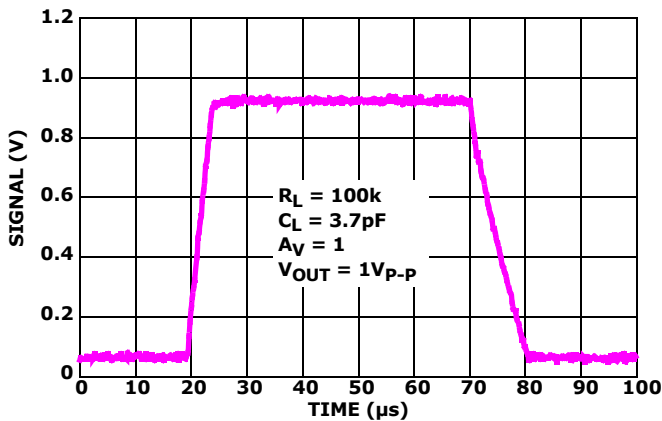

FIGURE 28. LARGE SIGNAL STEP RESPONSE (1V)

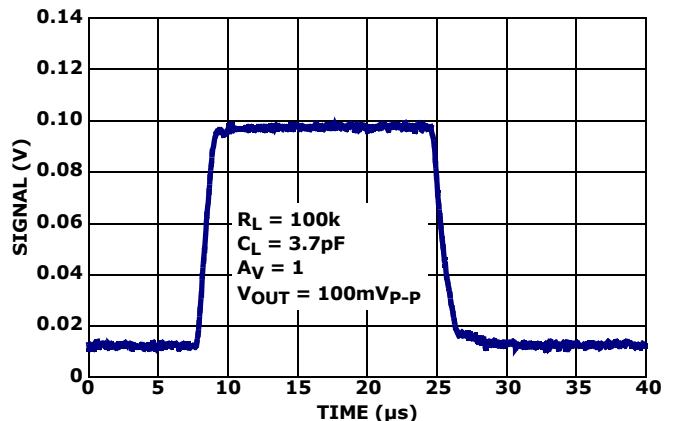

FIGURE 29. SMALL SIGNAL STEP RESPONSE (100mV)

Typical Performance Curves

$V_+ = 5V$, $V_- = 0V$, $V_{CM} = 2.5V$, $R_L = \text{Open}$, $T = +25^\circ\text{C}$, unless otherwise specified. (Continued)

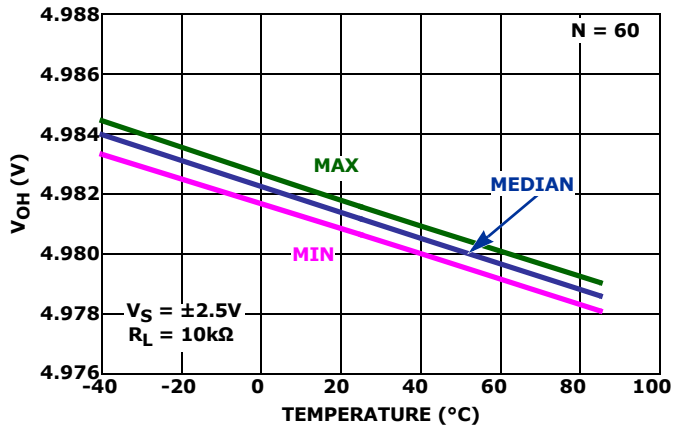

FIGURE 30. V_{OH} vs TEMPERATURE

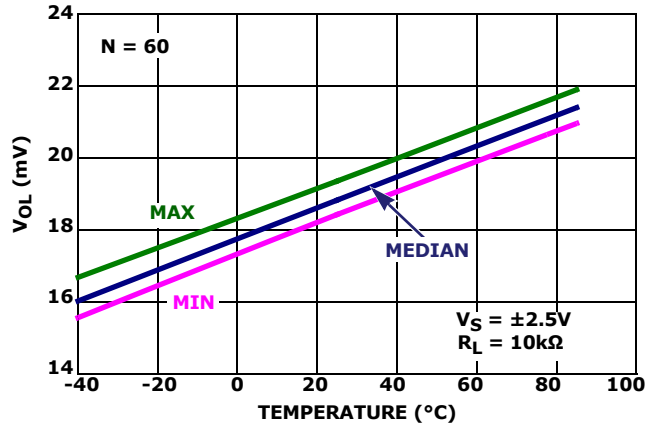

FIGURE 31. V_{OL} vs TEMPERATURE

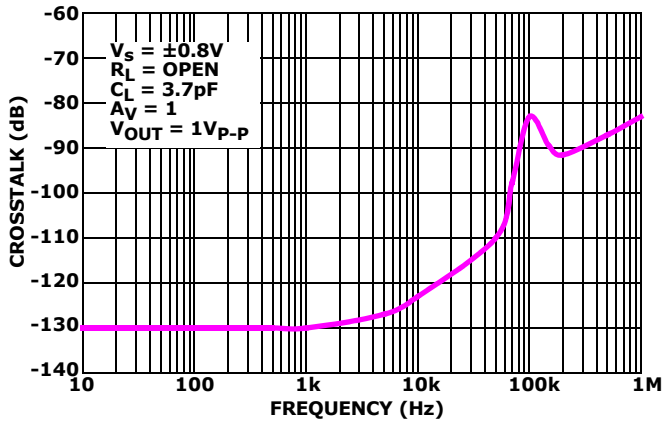

FIGURE 32. Crosstalk vs Frequency, $V_S = \pm 0.8V$

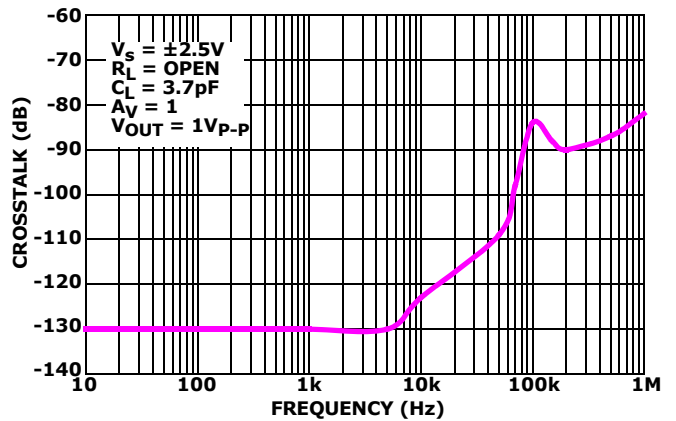

FIGURE 33. Crosstalk vs Frequency, $V_S = \pm 2.5V$

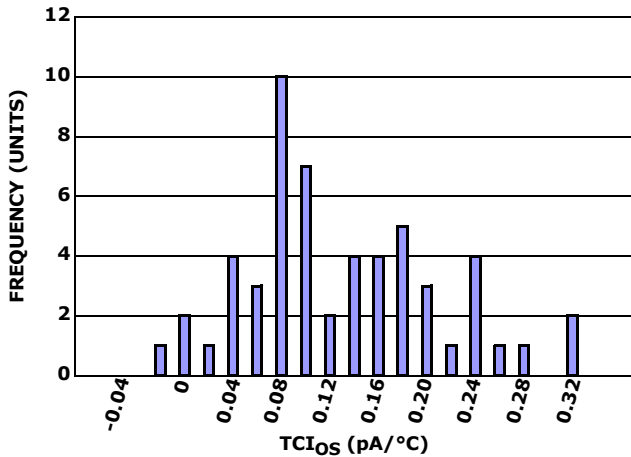

FIGURE 34. TCI_{OS} HISTOGRAM

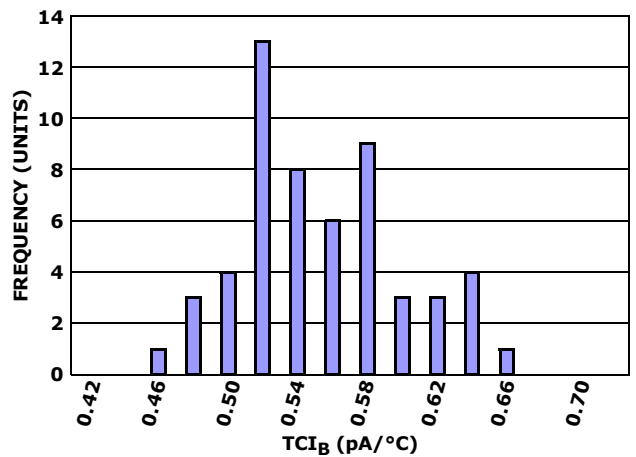

FIGURE 35. TCI_b HISTOGRAM

Typical Performance Curves

$V_+ = 5V$, $V_- = 0V$, $V_{CM} = 2.5V$, $R_L = \text{Open}$, $T = +25^\circ C$, unless otherwise specified. (Continued)

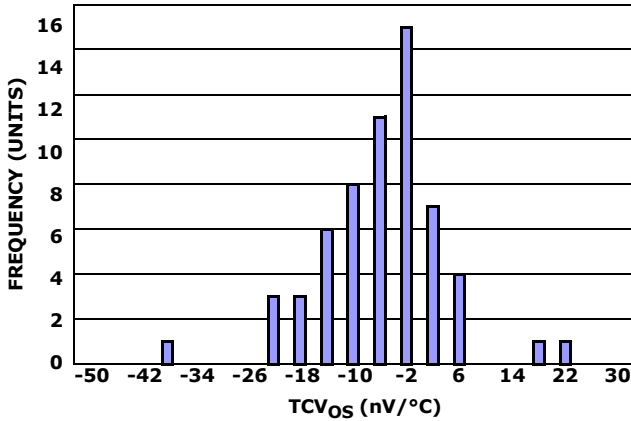

FIGURE 36. TCVOS HISTOGRAM

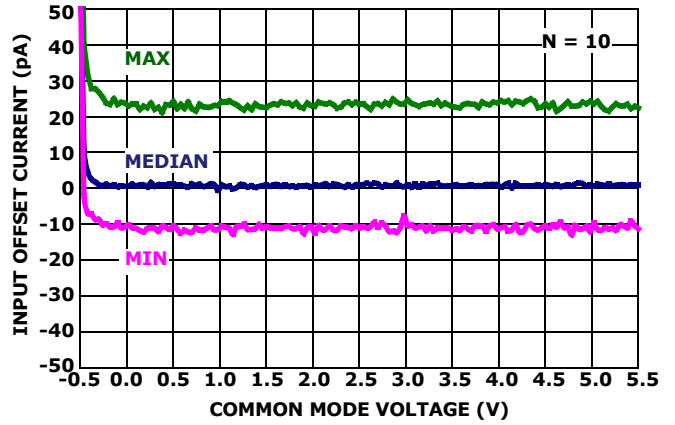

FIGURE 37. IOS vs VCM

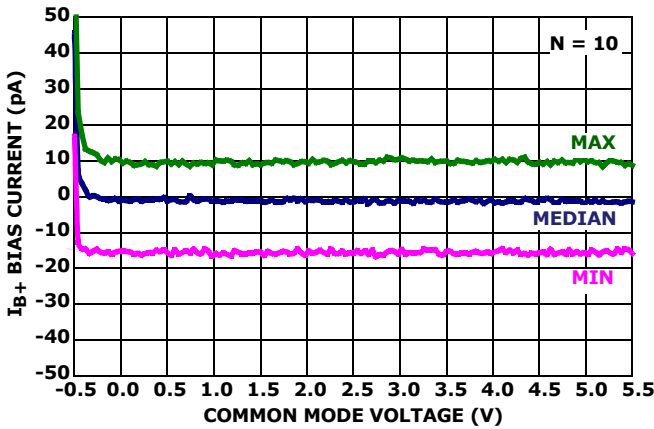

FIGURE 38. IB+ vs VCM

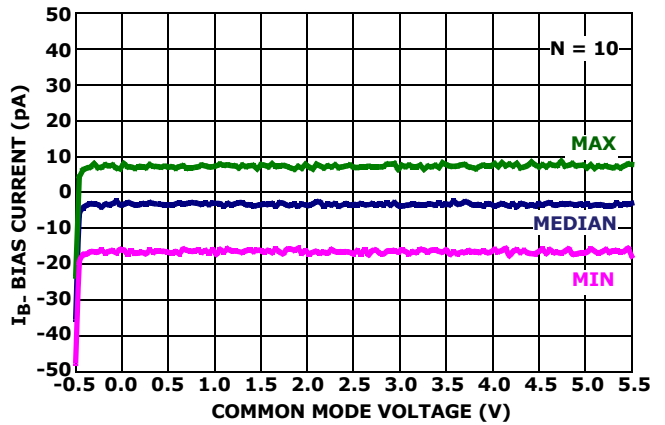

FIGURE 39. IB- vs VCM

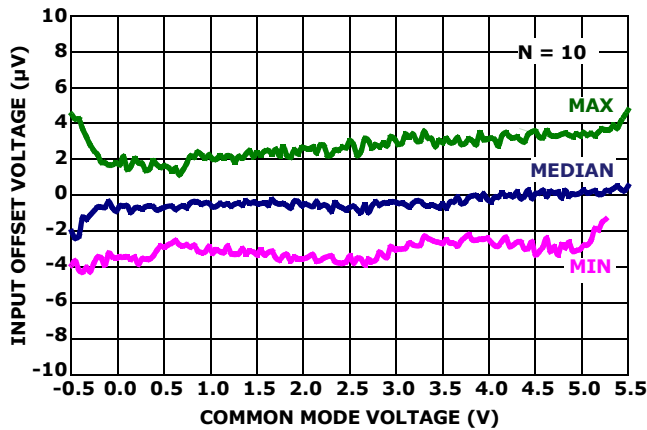

FIGURE 40. VOS vs VCM

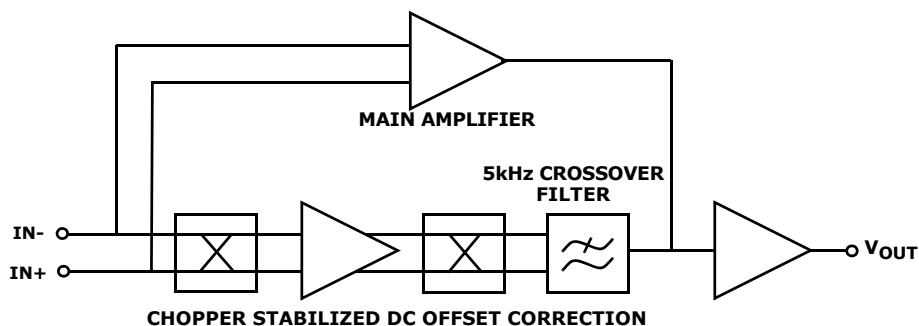

FIGURE 41. ISL28233IUZ FUNCTIONAL BLOCK DIAGRAM

Applications Information

Functional Description

The ISL28233IUZ uses a proprietary chopper-stabilized technique (see Figure 41) that combines a 400kHz main amplifier with a very high open loop gain (174dB) chopper amplifier to achieve very low offset voltage and drift ($2\mu\text{V}$, $0.02\mu\text{V}/^\circ\text{C}$ typical) while consuming only $18\mu\text{A}$ of supply current per channel.

This multi-path amplifier architecture contains a time continuous main amplifier whose input DC offset is corrected by a parallel-connected, high gain chopper stabilized DC correction amplifier operating at 100kHz. From DC to $\sim 5\text{kHz}$, both amplifiers are active with DC offset correction and most of the low frequency gain is provided by the chopper amplifier. A 5kHz crossover filter cuts off the low frequency amplifier path leaving the main amplifier active out to the 400kHz gain-bandwidth product of the device.

The key benefits of this architecture for precision applications are very high open loop gain, very low DC offset, and low $1/f$ noise. The noise is virtually flat across the frequency range from a few millihertz out to 100kHz, except for the narrow noise peak at the amplifier crossover frequency (5kHz).

Rail-to-rail Input and Output (RRIO)

The RRIO CMOS amplifier uses parallel input PMOS and NMOS that enable the inputs to swing 100mV beyond either supply rail. The inverting and non-inverting inputs do not have back-to-back input clamp diodes and are capable of maintaining high input impedance at high differential input voltages. This is effective in eliminating output distortion caused by high slew-rate input signals.

The output stage uses common source connected PMOS and NMOS devices to achieve rail-to-rail output drive capability with 17mA current limit and the capability to swing to within 20mV of either rail while driving a $10\text{k}\Omega$ load.

IN+ and IN- Protection

All input terminals have internal ESD protection diodes to both positive and negative supply rails, limiting the input voltage to within one diode beyond the supply rails. For applications where either input is expected to

exceed the rails by 0.5V , an external series resistor must be used to ensure the input currents never exceed 20mA (see Figure 42).

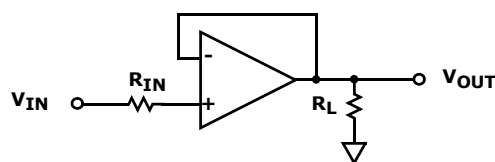

FIGURE 42. INPUT CURRENT LIMITING

Layout Guidelines for High Impedance Inputs

To achieve the maximum performance of the high input impedance and low offset voltage of the ISL28233IUZ, care should be taken in the circuit board layout. The PC board surface must remain clean and free of moisture to avoid leakage currents between adjacent traces. Surface coating of the circuit board will reduce surface moisture and provide a humidity barrier, reducing parasitic resistance on the board. The use of guard rings around the amplifier inputs will further reduce leakage currents. Figure 43 shows how the guard ring should be configured. The guard ring does not need to be a specific width, but it should form a continuous loop around both inputs. By setting the guard ring voltage equal to the voltage at the non-inverting input, parasitic capacitance is minimized as well.

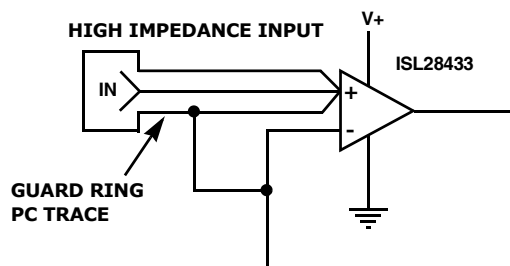

FIGURE 43. USE OF GUARD RINGS TO REDUCE

High Gain, Precision DC-Coupled Amplifier

The circuit in Figure 44 implements a single-stage DC-coupled amplifier with an input DC sensitivity of under 100nV that is only possible using a low VOS amplifier with high open loop gain. High gain DC

amplifiers operating from low voltage supplies are not practical using typical low offset precision op amps. For example, the typical $\pm 100\mu\text{V}$ V_{OS} and offset drift $0.5\mu\text{V}/^\circ\text{C}$ of a low offset op amp would produce a DC error of $>1\text{V}$ with an additional $5\text{mV}/^\circ\text{C}$ of temperature dependent error making it difficult to resolve DC input voltage changes in the mV range.

The $\pm 8\mu\text{V}$ max V_{OS} and $0.06\mu\text{V}/^\circ\text{C}$ of the ISL28233IUZ produces a temperature stable maximum DC output error of only $\pm 80\text{mV}$ with a maximum temperature drift of $0.06\mu\text{V}/^\circ\text{C}$. The additional benefit of a very low 1/f noise corner frequency and some feedback filtering enables DC voltages and voltage fluctuations well below 100nV to be easily detected with a simple single stage amplifier.

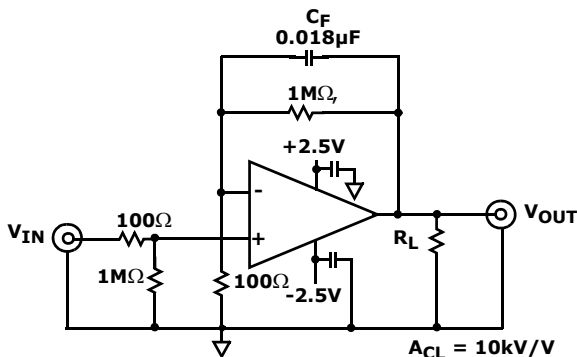

FIGURE 44. HIGH GAIN, PRECISION DC-COUPLED AMPLIFIER

ISL28233IUZ SPICE Model

Figure 45 shows the SPICE model schematic and Figure 46 shows the net list for the ISL28233IUZ SPICE model. The model is a simplified version of the actual device and simulates important parameters such as noise, Slew Rate, Gain and Phase. The model uses typical parameters from the "Electrical Specifications Table" on page 4. The poles and zeroes in the model were determined from the actual open and closed-loop gain and phase response. This enables the model to present an accurate AC representation of the actual device. The model is configured for ambient temperature of $+25^\circ\text{C}$.

Figures 47 through 54 show the characterization vs simulation results for the Noise Density, Frequency Response vs Close Loop Gain, Gain vs Frequency vs CL and Large Signal Step Response (4V).

LICENSE STATEMENT

The information in this SPICE model is protected under the United States copyright laws. Intersil Corporation hereby grants users of this macro-model hereto referred to as "Licensee", a nonexclusive, nontransferable licence to use this model as long as the Licensee abides by the terms of this agreement. Before using this macro-model, the Licensee should read this license. If the Licensee does not accept these terms, permission to use the model is not granted.

The Licensee may not sell, loan, rent, or license the macro-model, in whole, in part, or in modified form, to anyone outside the Licensee's company. The Licensee may modify the macro-model to suit his/her specific applications, and the Licensee may make copies of this macro-model for use within their company only.

This macro-model is provided "AS IS, WHERE IS, AND WITH NO WARRANTY OF ANY KIND EITHER EXPRESSED OR IMPLIED, INCLUDING BUY NOT LIMITED TO ANY IMPLIED WARRANTIES OF MERCHANTABILITY AND FITNESS FOR A PARTICULAR PURPOSE."

In no event will Intersil be liable for special, collateral, incidental, or consequential damages in connection with or arising out of the use of this macro-model. Intersil reserves the right to make changes to the product and the macro-model without prior notice.

ISL28233I

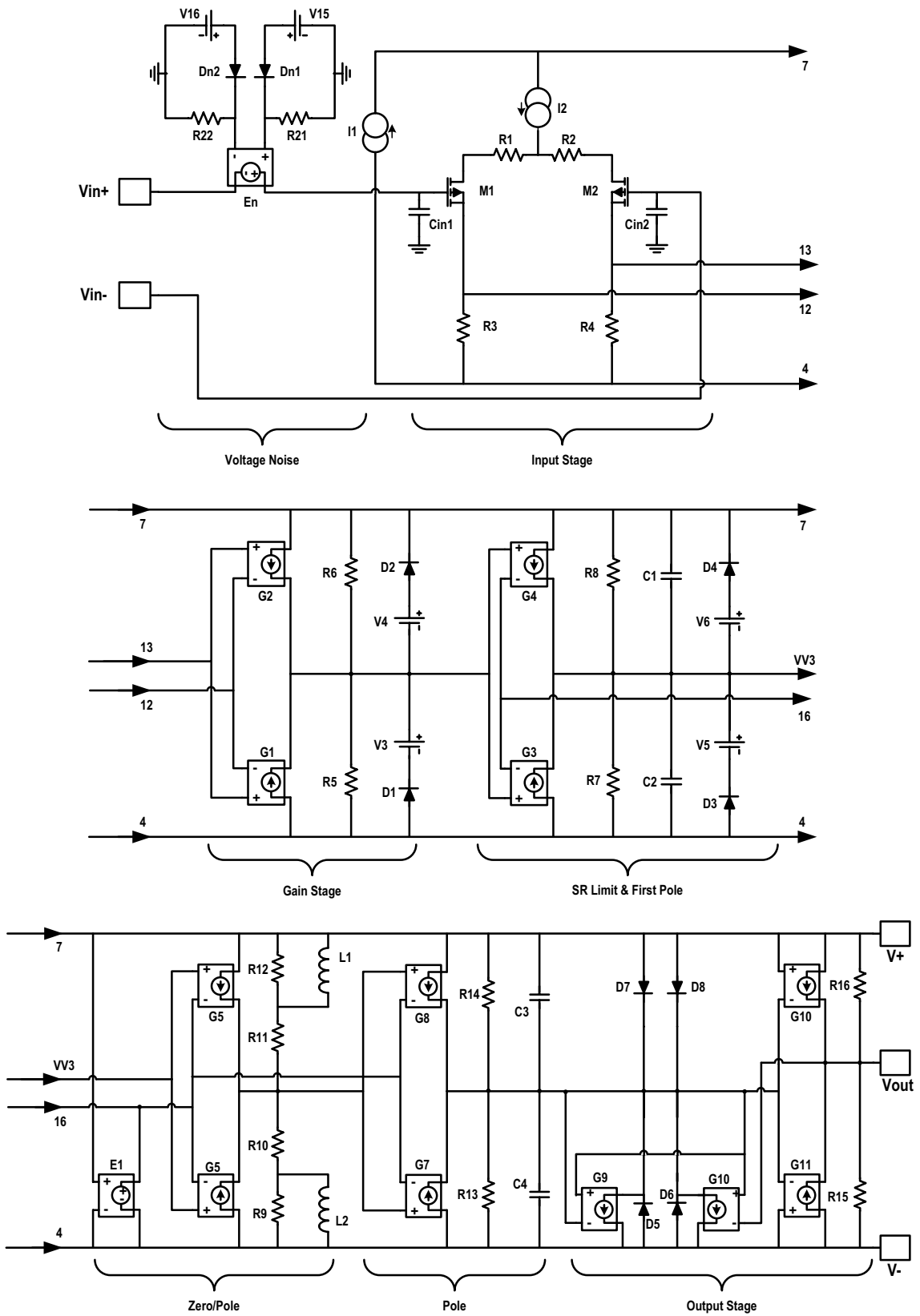

FIGURE 45. SPICE CIRCUIT SCHEMATIC

Characterization vs Simulation Results

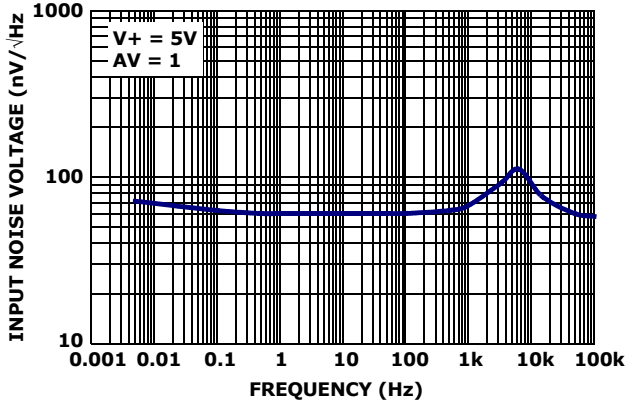

FIGURE 47. CHARACTERIZED INPUT NOISE VOLTAGE DENSITY vs FREQUENCY

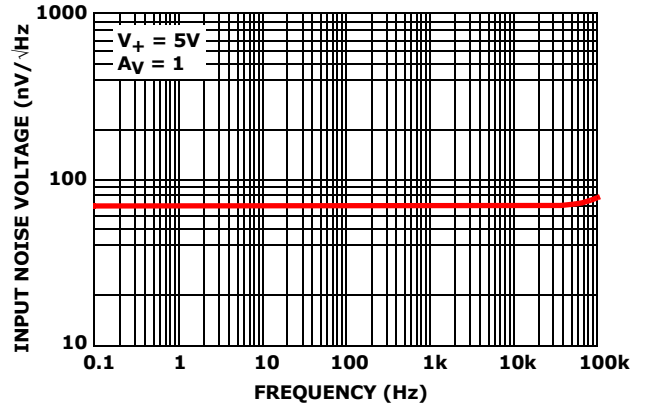

FIGURE 48. SIMULATED INPUT NOISE VOLTAGE DENSITY vs FREQUENCY

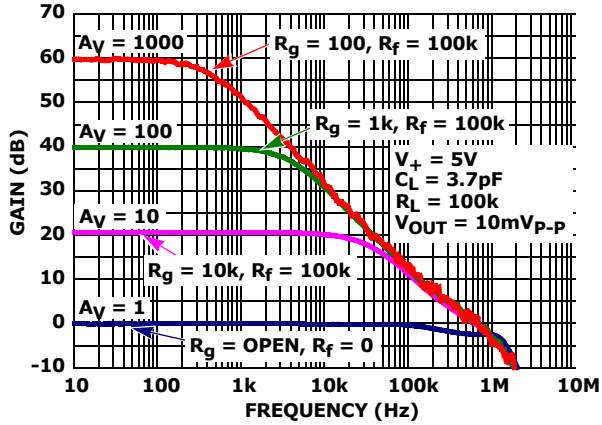

FIGURE 49. CHARACTERIZED FREQUENCY RESPONSE vs CLOSED LOOP GAIN

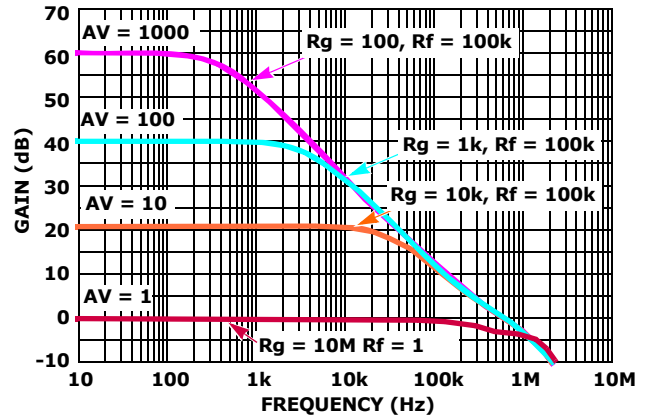

FIGURE 50. SIMULATED FREQUENCY RESPONSE vs CLOSED LOOP GAIN

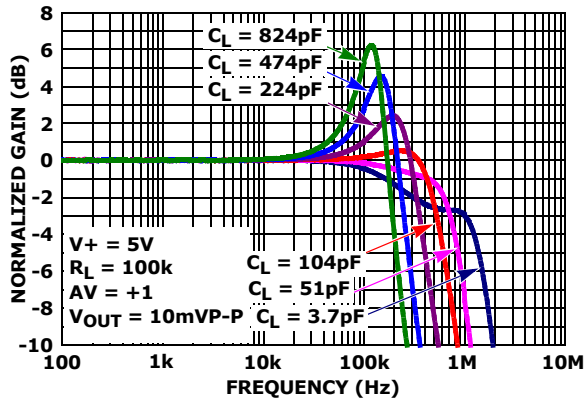

FIGURE 51. CHARACTERIZED GAIN vs FREQUENCY vs C_L

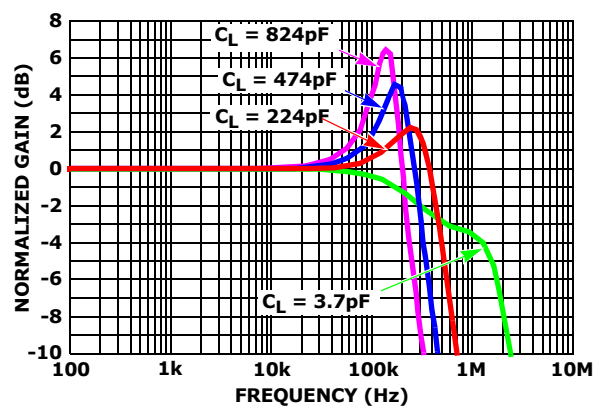

FIGURE 52. SIMULATED GAIN vs FREQUENCY vs C_L

Characterization vs Simulation Results (Continued)

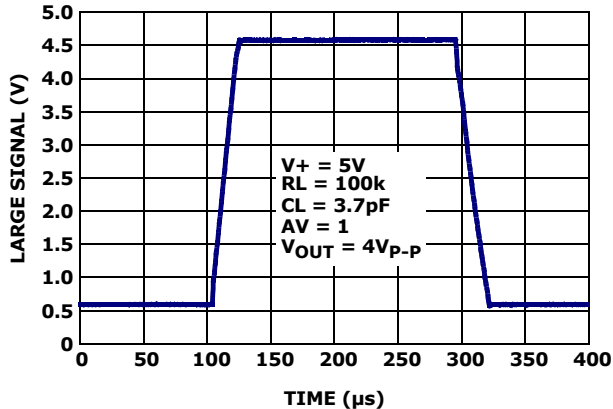

FIGURE 53. CHARACTERIZED LARGE SIGNAL STEP RESPONSE (4V)

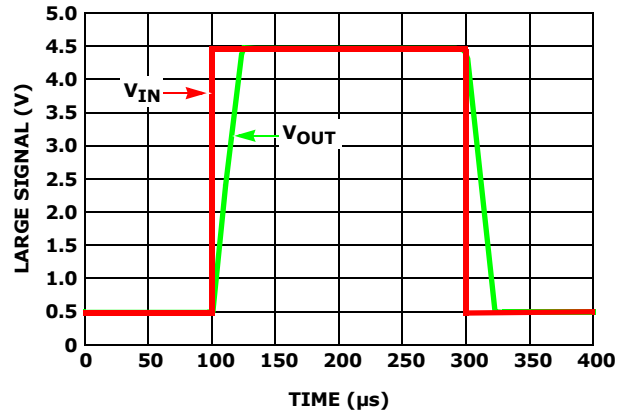

FIGURE 54. SIMULATED LARGE SIGNAL STEP RESPONSE (4V)

Revision History

The revision history provided is for informational purposes only and is believed to be accurate, but not warranted. Please go to web to make sure you have the latest Rev.

DATE	REVISION	CHANGE
10/8/11	FN6942.2	Removed "UZ" from Device number top of all pages.
8/23/10	FN6942.1	Removed all ISL28433 device information from data sheet. Stamped not recommended for new designs since these parts are going to be obsolete. Recommended replacement part ISL28233FUZ.
3/25/10	FN6942.0	Initial Release.

Products

Intersil Corporation is a leader in the design and manufacture of high-performance analog semiconductors. The Company's products address some of the industry's fastest growing markets, such as, flat panel displays, cell phones, handheld products, and notebooks. Intersil's product families address power management and analog signal processing functions. Go to www.intersil.com/products for a complete list of Intersil product families.

*For a complete listing of Applications, Related Documentation and Related Parts, please see the respective device information page on intersil.com: [ISL28233I](http://www.intersil.com/ISL28233I)

To report errors or suggestions for this datasheet, please go to www.intersil.com/askourstaff

FITs are available from our website at <http://rel.intersil.com/reports/search.php>

For additional products, see www.intersil.com/product_tree

Intersil products are manufactured, assembled and tested utilizing ISO9000 quality systems as noted in the quality certifications found at www.intersil.com/design/quality

Intersil products are sold by description only. Intersil Corporation reserves the right to make changes in circuit design, software and/or specifications at any time without notice. Accordingly, the reader is cautioned to verify that data sheets are current before placing orders. Information furnished by Intersil is believed to be accurate and reliable. However, no responsibility is assumed by Intersil or its subsidiaries for its use; nor for any infringements of patents or other rights of third parties which may result from its use. No license is granted by implication or otherwise under any patent or patent rights of Intersil or its subsidiaries.

For information regarding Intersil Corporation and its products, see www.intersil.com

Package Outline Drawing

M8.118A

8 LEAD MINI SMALL OUTLINE PLASTIC PACKAGE (MSOP)

Rev 0, 9/09

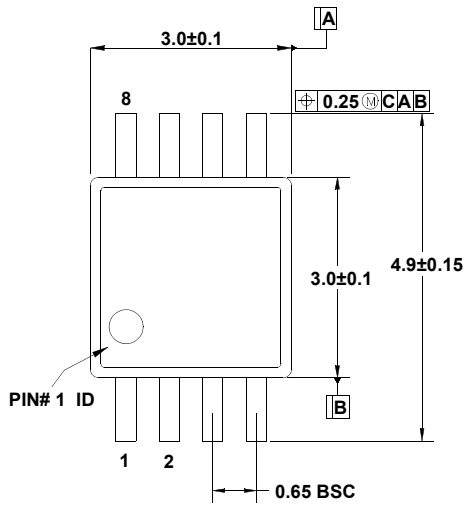

TOP VIEW

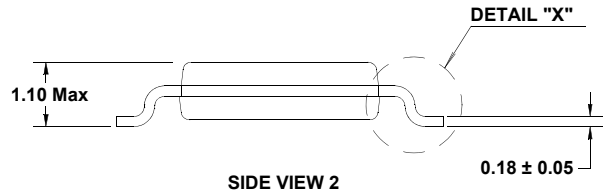

SIDE VIEW 2

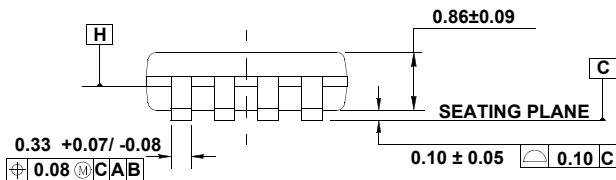

SIDE VIEW 1

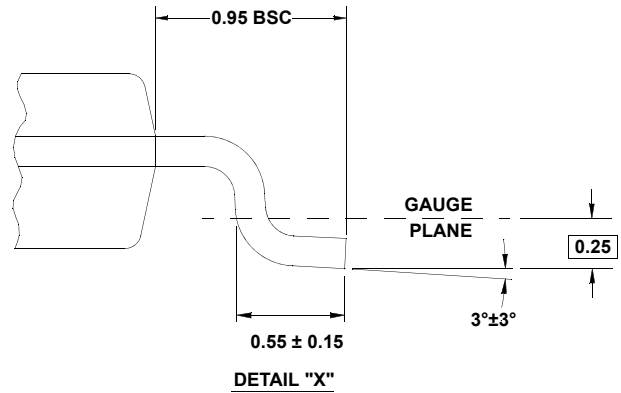

DETAIL "X"

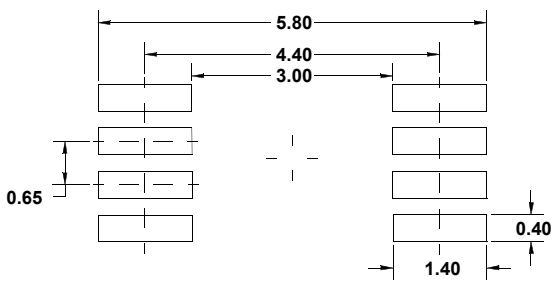

TYPICAL RECOMMENDED LAND PATTERN

NOTES:

1. Dimensions are in millimeters.
2. Dimensioning and tolerancing conform to JEDEC MO-187-AA and AMSE Y14.5m-1994.
3. Plastic or metal protrusions of 0.15mm max per side are not included.
4. Plastic interlead protrusions of 0.25mm max per side are not included.
5. Dimensions "D" and "E1" are measured at Datum Plane "H".
6. This replaces existing drawing # MDP0043 MSOP 8L.