

TN3467A

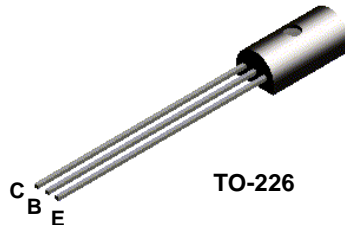

MMPQ3467

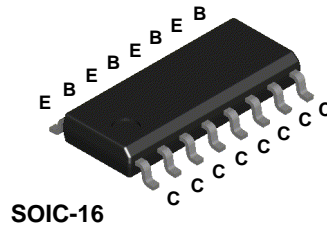

PNP Switching Transistor

This device is designed for high speed saturated switching applications at currents to 800 mA. Sourced from Process 70.

Absolute Maximum Ratings*

TA = 25°C unless otherwise noted

Symbol	Parameter	Value	Units
V _{CEO}	Collector-Emitter Voltage	40	V
V _{CBO}	Collector-Base Voltage	40	V
V _{EBO}	Emitter-Base Voltage	5.0	V
I _C	Collector Current - Continuous	1.2	A
T _J , T _{stg}	Operating and Storage Junction Temperature Range	-55 to +150	°C

*These ratings are limiting values above which the serviceability of any semiconductor device may be impaired.

NOTES:

- 1) These ratings are based on a maximum junction temperature of 150 degrees C.
- 2) These are steady state limits. The factory should be consulted on applications involving pulsed or low duty cycle operations.

Thermal Characteristics

TA = 25°C unless otherwise noted

Symbol	Characteristic	Max		Units
		TN3467A	MMPQ3467	
P _D	Total Device Dissipation Derate above 25°C	1.0	1.0	W
		8.0	8.0	mW/°C
R _{θJC}	Thermal Resistance, Junction to Case	50		°C/W
R _{θJA}	Thermal Resistance, Junction to Ambient Effective 4 Die Each Die	125		°C/W
			125	°C/W
			240	°C/W

PNP Switching Transistor

(continued)

Electrical Characteristics

TA = 25°C unless otherwise noted

Symbol	Parameter	Test Conditions	Min	Max	Units
OFF CHARACTERISTICS					
$V_{(BR)CEO}$	Collector-Emitter Breakdown Voltage*	$I_C = 10 \text{ mA}, I_B = 0$	40		V
$V_{(BR)CBO}$	Collector-Base Breakdown Voltage	$I_C = 10 \text{ } \mu\text{A}, I_E = 0$	40		V
$V_{(BR)EBO}$	Emitter-Base Breakdown Voltage	$I_E = 10 \text{ } \mu\text{A}, I_C = 0$	5.0		V
I_{BEV}	Base-Cutoff Current	$V_{CE} = 30 \text{ V}, V_{BE} = 3.0 \text{ V}$		120	nA
I_{CEX}	Collector-Cutoff Current	$V_{CE} = 30 \text{ V}, V_{BE} = 3.0 \text{ V}$		100	nA
I_{CBO}	Collector-Cutoff Current	$V_{CB} = 30 \text{ V}, I_E = 0$ $V_{CB} = 30 \text{ V}, I_E = 0, T_A = 150^\circ\text{C}$		0.01 15	μA μA

ON CHARACTERISTICS*

h_{FE}	DC Current Gain	$I_C = 150 \text{ mA}, V_{CE} = 1.0 \text{ V}$ $I_C = 500 \text{ mA}, V_{CE} = 1.0 \text{ V}$ $I_C = 1.0 \text{ A}, V_{CE} = 5.0 \text{ V}$	40 40 40	120	
$V_{CE(sat)}$	Collector-Emitter Saturation Voltage	$I_C = 150 \text{ mA}, I_B = 15 \text{ mA}$ $I_C = 500 \text{ mA}, I_B = 50 \text{ mA}$ $I_C = 1.0 \text{ A}, I_B = 100 \text{ mA}$		0.3 0.5 1.0	V V V
$V_{BE(sat)}$	Base-Emitter Saturation Voltage	$I_C = 150 \text{ mA}, I_B = 15 \text{ mA}$ $I_C = 500 \text{ mA}, I_B = 50 \text{ mA}$ $I_C = 1.0 \text{ A}, I_B = 100 \text{ mA}$	0.8	1.0 1.2 1.6	V V V

SMALL SIGNAL CHARACTERISTICS

f_T	Current Gain-Bandwidth Product	$I_C = 50 \text{ mA}, V_{CE} = 10 \text{ V},$ $f = 100 \text{ MHz}$	175		MHz
C_{obo}	Output Capacitance	$V_{CB} = 10 \text{ V}, I_E = 0, f = 1.0 \text{ KHz}$		25	pF
C_{ibo}	Input Capacitance	$V_{BE} = 0.5 \text{ V}, I_C = 0, f = 1.0 \text{ KHz}$		100	pF

SWITCHING CHARACTERISTICS (except for MMPQ3467)

t_d	Delay Time	$V_{CC} = 30 \text{ V}, V_{BE} = 2.0 \text{ V},$		10	ns
t_r	Rise Time	$I_C = 500 \text{ mA}, I_{B1} = 50 \text{ mA}$		30	ns
t_s	Storage Time	$V_{CC} = 30 \text{ V}, I_C = 500 \text{ mA},$		60	ns
t_f	Fall Time	$I_{B1} = I_{B2} = 50 \text{ mA}$		30	ns

*Pulse Test: Pulse Width $\leq 300 \text{ } \mu\text{s}$, Duty Cycle $\leq 1.0\%$

TN3467A / MMPQ3467

DC Typical Characteristics

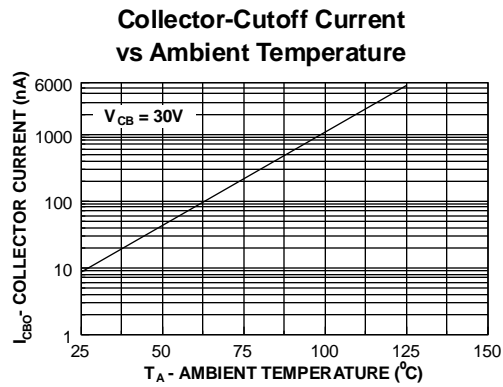
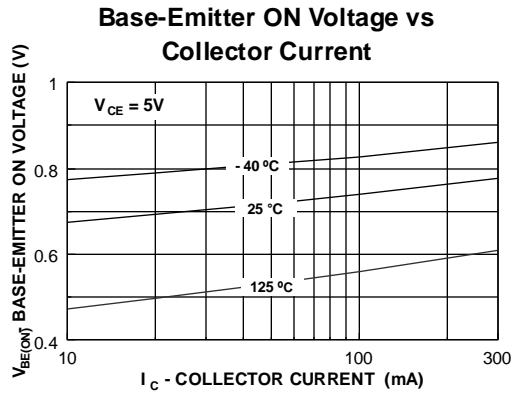
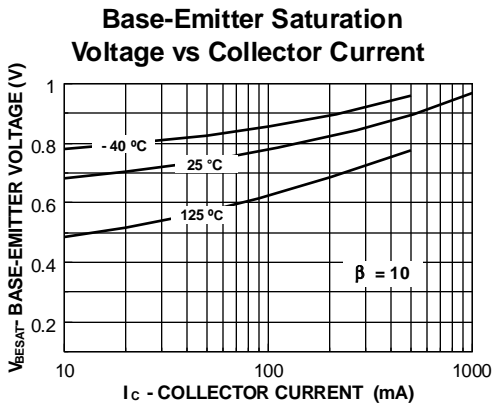
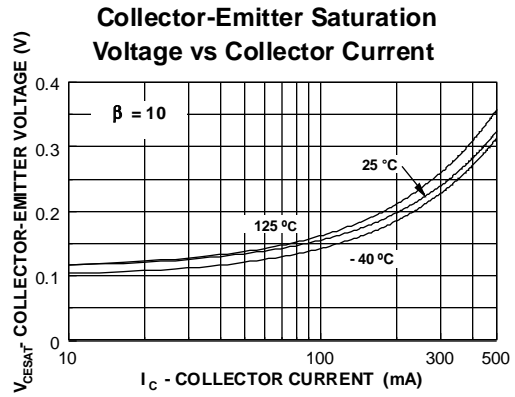
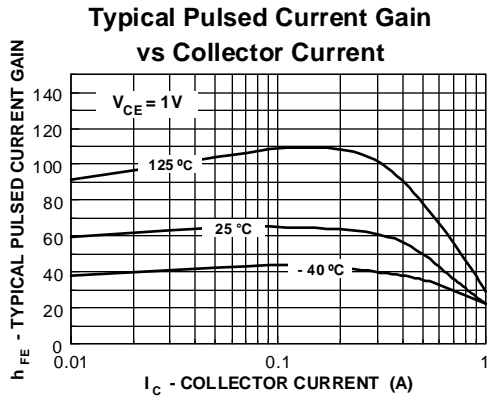

AC Typical Characteristics

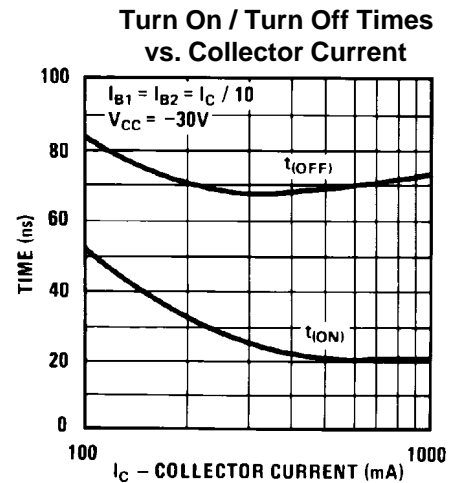
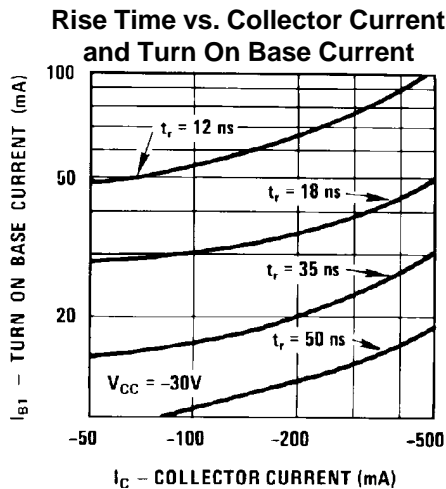
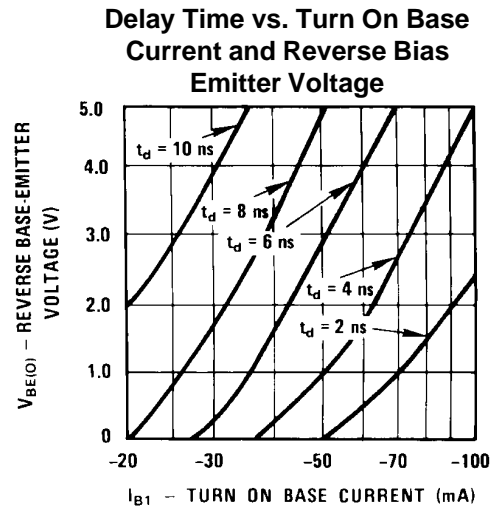
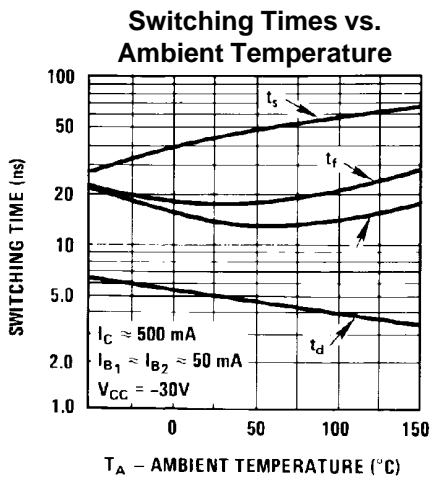
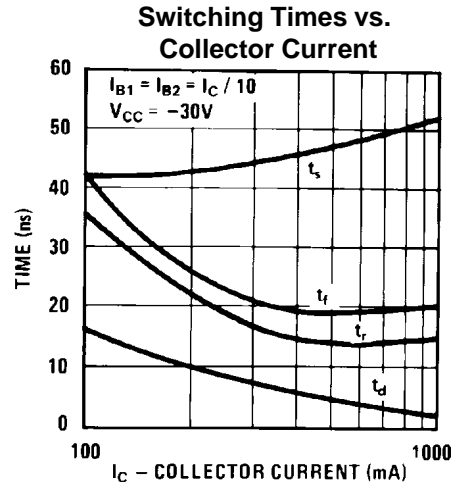
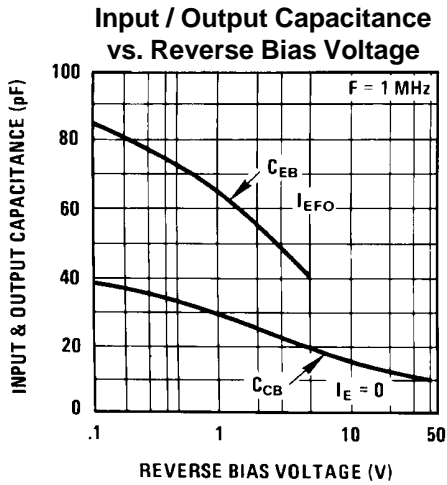

AC Typical Characteristics (continued)

Fall Time vs. Turn On and Turn Off Base Currents

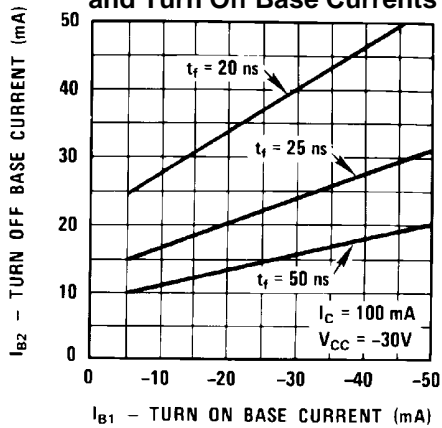

Fall Time vs. Turn On and Turn Off Base Currents

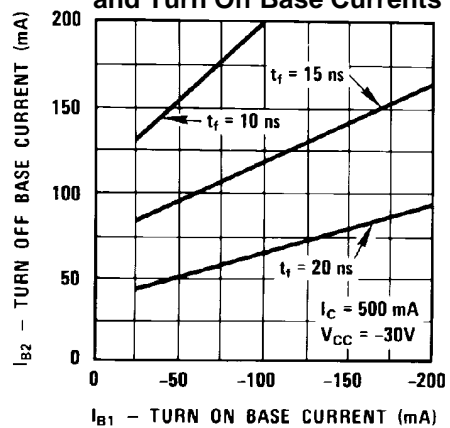

Storage Time vs. Turn On and Turn Off Base Currents

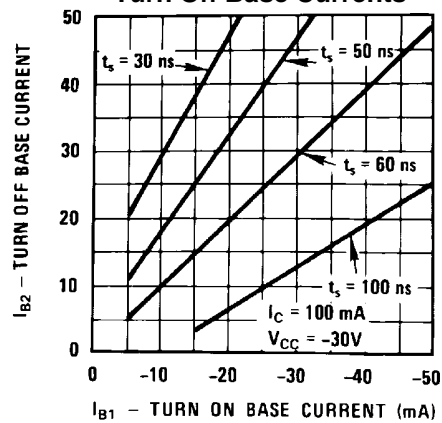

Storage Time vs. Turn On and Turn Off Base Currents

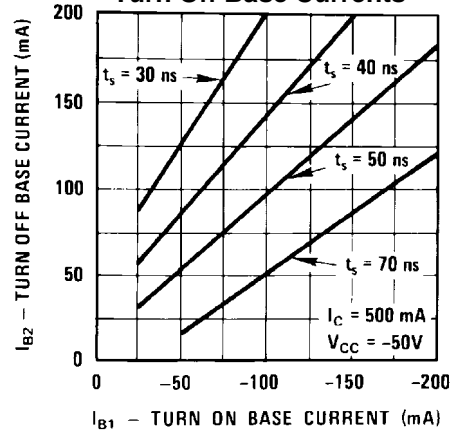

AC Typical Characteristics (continued)

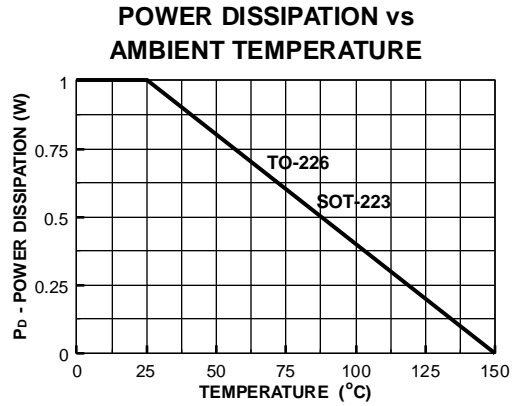
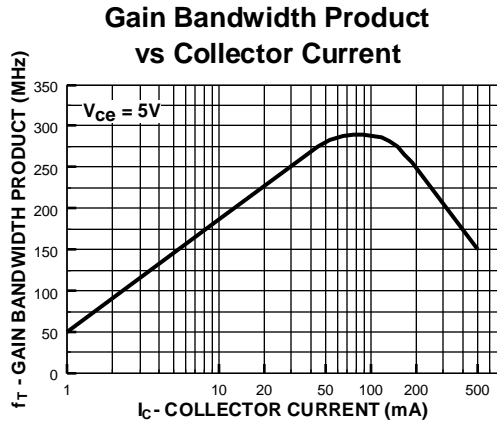

Test Circuits

PW = 200 ns
Rise Time \leq 2.0 ns
Duty Cycle = 2%

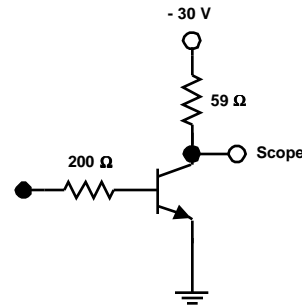
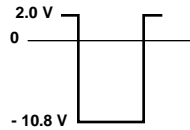

FIGURE 1: t_{ON} Equivalent Test Circuit

$2.0 < t_1 < 500 \mu s$
 $t_2 < 5 ns$
 $t_3 > 1.0 \mu s$
Duty Cycle = 2%

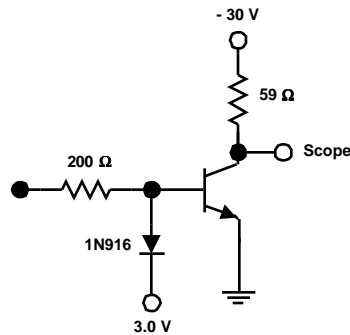
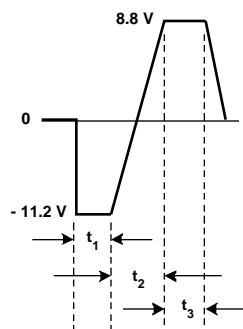

FIGURE 2: t_{OFF} Equivalent Test Circuit