

**Fast CMOS Octal Bidirectional Transceivers**

**Features**

- Pin compatible with bipolar FAST™ Series at a higher speed and lower power consumption
- 25-ohm series resistor on all outputs (FCT2245T only)
- TTL input and output levels
- Low ground bounce outputs
- Extremely low static power
- Hysteresis on all inputs
- Industrial operating temperature range: -40°C to +85°C
- Packaging (Pb-free & Green Available):
  - 20-pin 173-mil wide plastic TSSOP (L)
  - 20-pin 300-mil wide plastic SOIC (S)
  - 20-pin 209-mil wide plastic SSOP (H)
  - 20-pin 150-mil wide plastic QSOP (Q)

**Description**

Pericom Semiconductor's PI74FCT245T and PI74FCT2245T are 8-bit wide octal buffer bidirectional transceivers designed for asynchronous two-way communication between data buses. The transmit/receive (T/R) input determines the direction of data flow through the bidirectional transceiver. Transmit (active HIGH) enables data from A ports to B ports, and receive (active LOW) from B ports to A ports. The output enable ( $\overline{OE}$ ) input, when HIGH, disables both A and B ports by placing them in Hi-Z condition.

PI74FCT2245T has a built-in 25-ohm series resistor on all outputs to reduce noise because of reflections, thus eliminating the need for an external terminating resistor.

**Block Diagram**

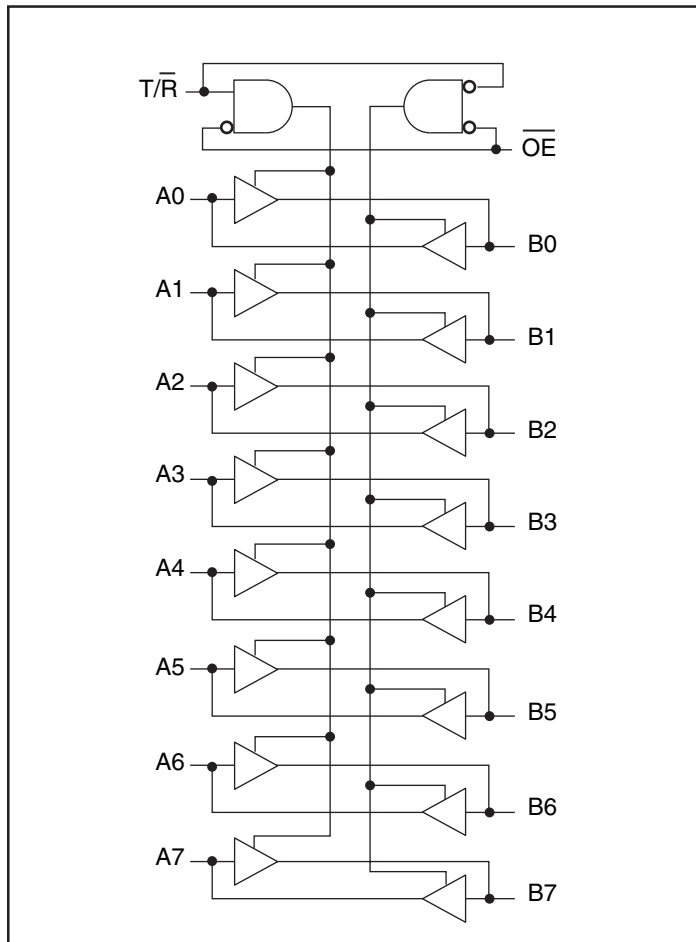

**Pin Configuration**

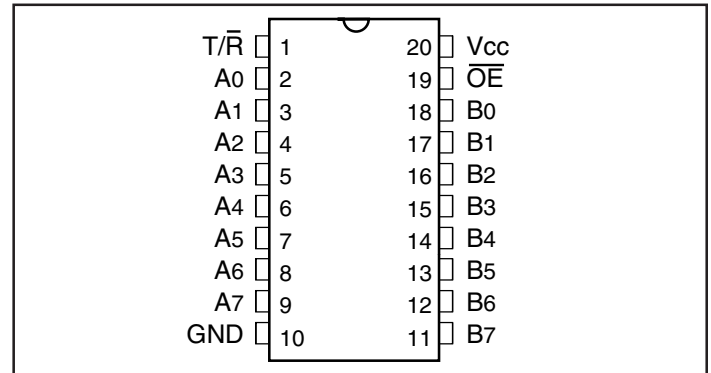

**Pin Description**

Pin Name	Description
$\overline{OE}$	3-State Output Enable Inputs (Active LOW)
T/ $\overline{R}$	Transmit/Receive Input
A0-A7	Side A Inputs or 3-State Outputs
B0-B7	Side B Inputs or 3-State Outputs
GND	Ground
VCC	Power

**Truth Table<sup>(1)</sup>**

Inputs		Outputs
$\overline{OE}$	T/ $\overline{R}$	
L	L	Bus B Data to Bus A
L	H	Bus A Data to Bus B
H	X	High Z State

1. H = High Voltage Level, X = Don't Care, L = Low Voltage Level, Z = High Impedance

### Maximum Ratings

(Above which the useful life may be impaired. For user guidelines, not tested.)

Storage Temperature .....	-65°C to +150°C
Ambient Temperature with Power Applied .....	-40°C to +85°C
Supply Voltage to Ground Potential (Inputs & V <sub>CC</sub> Only) .....	-0.5V to +7.0V
Supply Voltage to Ground Potential (Outputs & D/O Only) .....	-0.5V to +7.0V
DC Input Voltage .....	-0.5V to +7.0V
DC Output Current .....	120mA
Power Dissipation .....	0.5W

**Note:**

Stresses greater than those listed under MAXIMUM RATINGS may cause permanent damage to the device. This is a stress rating only and functional operation of the device at these or any other conditions above those indicated in the operational sections of this specification is not implied. Exposure to absolute maximum rating conditions for extended periods may affect reliability.

### DC Electrical Characteristics (Over the Operating Range, T<sub>A</sub> = -40°C to +85°C, V<sub>CC</sub> = 5.0V ±5%)

Parameters	Description	Test Conditions <sup>(1)</sup>	Min.	Typ <sup>(2)</sup>	Max.	Units	
V <sub>OH</sub>	Output HIGH Voltage	V <sub>CC</sub> = Min., V <sub>IN</sub> = V <sub>IH</sub> or V <sub>IL</sub>	I <sub>OH</sub> = -15.0mA	2.4	3.0	V	
V <sub>OL</sub>	Output LOW Current	V <sub>CC</sub> = Min., V <sub>IN</sub> = V <sub>IH</sub> or V <sub>IL</sub>	I <sub>OL</sub> = 64mA		0.3	0.55	V
V <sub>OL</sub>	Output LOW Current	V <sub>CC</sub> = Min., V <sub>IN</sub> = V <sub>IH</sub> or V <sub>IL</sub>	I <sub>OL</sub> = 12mA (25Ω Series)		0.3	0.50	V
V <sub>IH</sub>	Input HIGH Voltage	Guaranteed Logic HIGH Level		2.0			V
V <sub>IL</sub>	Input LOW Voltage	Guaranteed Logic LOW Level				0.8	V
I <sub>IH</sub>	Input HIGH Current	(Except I/O pins) V <sub>CC</sub> = Max.	V <sub>IN</sub> = V <sub>CC</sub>			1	μA
I <sub>IL</sub>	Input LOW Current	(Except I/O pins) V <sub>CC</sub> = Max.	V <sub>IN</sub> = GND			-1	μA
I <sub>IH</sub>	Input HIGH Current	(I/O pins Only) V <sub>CC</sub> = Max.	V <sub>IN</sub> = V <sub>CC</sub>			1	μA
I <sub>IL</sub>	Input LOW Current	(I/O pins Only) V <sub>CC</sub> = Max.	V <sub>IN</sub> = GND			-1	μA
I <sub>OZH</sub>	High Impedance	V <sub>CC</sub> = MAX.	V <sub>OUT</sub> = 2.7V			1	μA
I <sub>OZL</sub>	Output Current		V <sub>OUT</sub> = 0.5V			-1	μA
V <sub>IK</sub>	Clamp Diode Voltage	V <sub>CC</sub> = Min., I <sub>IN</sub> = -18 mA			-0.7	-1.2	V
I <sub>OFF</sub>	Power Down Disable	V <sub>CC</sub> = GND, V <sub>OUT</sub> = 4.5V				100	μA
I <sub>OS</sub>	Short Circuit Current	V <sub>CC</sub> = Max. <sup>(3)</sup> , V <sub>OUT</sub> = GND		-60	-120		mA
V <sub>H</sub>	Input Hysteresis				200		mV

**Notes:**

- For Max. or Min. conditions, use appropriate value specified under Electrical Characteristics for the applicable device type.
- Typical values are at V<sub>CC</sub> = 5.0V, +25°C ambient and maximum loading.
- Not more than one output should be shorted at one time. Duration of the test should not exceed one second.

### Capacitance (T<sub>A</sub> = 25°C, f = 1 MHz)

Parameters <sup>(1)</sup>	Description	Test Conditions	Typ.	Max.	Units
C <sub>IN</sub>	Input Capacitance	V <sub>IN</sub> = 0V	6	10	pF
C <sub>OUT</sub>	Output Capacitance	V <sub>OUT</sub> = 0V	8	12	pF

**Notes:**

- These Parameters are determined by device characterization but are not production tested.

### Power Supply Characteristics

Parameters	Description	Test Conditions <sup>(1)</sup>		Min.	Typ <sup>(2)</sup>	Max.	Units
I <sub>CC</sub>	Quiescent Power Supply Current	V <sub>CC</sub> =Max.	V <sub>IN</sub> = GND or V <sub>CC</sub>		0.1	500	μA
ΔI <sub>CC</sub>	Supply Current per Input @ TTL HIGH	V <sub>CC</sub> =Max.,	V <sub>IN</sub> =3.4V <sup>(3)</sup>		0.5	2.0	mA
I <sub>CCD</sub>	Supply Current per Input per MHz <sup>(4)</sup>	V <sub>CC</sub> =Max., Outputs Open $\overline{OE}$ =GND T/R = GND or V <sub>CC</sub> One Input Toggling 50% Duty Cycle	V <sub>IN</sub> =V <sub>CC</sub> V <sub>IN</sub> =GND		0.15	0.25	mA/ MHz
I <sub>C</sub>	Total Power Supply Current <sup>(6)</sup>	V <sub>CC</sub> =Max., Outputs Open f <sub>i</sub> = 10 MHz 50% Duty Cycle T/R = $\overline{OE}$ = GND One Bit Toggling	V <sub>IN</sub> =V <sub>CC</sub> V <sub>IN</sub> =GND		1.5	3.5 <sup>(5)</sup>	mA
			V <sub>IN</sub> =3.4V V <sub>IN</sub> =GND		1.8	4.5 <sup>(5)</sup>	
		V <sub>CC</sub> =Max., Outputs Open f <sub>i</sub> = 2.5 MHz 50% Duty Cycle T/R = $\overline{OE}$ = GND Eight Bits Toggling	V <sub>IN</sub> =V <sub>CC</sub> V <sub>IN</sub> =GND		3.0	6.0 <sup>(5)</sup>	
			V <sub>IN</sub> =3.4V V <sub>IN</sub> =GND		5.0	14.0 <sup>(5)</sup>	

**Notes:**

- For Max. or Min. conditions, use appropriate value specified under Electrical Characteristics for the applicable device.
- Typical values are at V<sub>CC</sub> = 5.0V, +25°C ambient.
- Per TTL driven input (V<sub>IN</sub> = 3.4V); all other inputs at V<sub>CC</sub> or GND.
- This parameter is not directly testable, but is derived for use in Total Power Supply Calculations.
- Values for these conditions are examples of the I<sub>CC</sub> formula. These limits are guaranteed but not tested.

6.  $I_C = I_{\text{QUIESCENT}} + I_{\text{INPUTS}} + I_{\text{DYNAMIC}}$   
 $I_C = I_{CC} + \Delta I_{CC} D_{\text{HNT}} + I_{CCD} (f_{CP}/2 + f_i N_I)$   
I<sub>CC</sub> = Quiescent Current  
ΔI<sub>CC</sub> = Power Supply Current for a TTL High Input (V<sub>IN</sub> = 3.4V)  
D<sub>H</sub> = Duty Cycle for TTL Inputs High  
N<sub>T</sub> = Number of TTL Inputs at D<sub>H</sub>  
I<sub>CCD</sub> = Dynamic Current Caused by an Input Transition Pair (HLH or LHL)  
f<sub>CP</sub> = Clock Frequency for Register Devices (Zero for Non-Register Devices)  
f<sub>i</sub> = Input Frequency  
N<sub>I</sub> = Number of Inputs at f<sub>i</sub>  
All currents are in milliamps and all frequencies are in megahertz.

### Switching Characteristics over Operating Range

Parameters	Description	Conditions <sup>(1)</sup>	245T/2245T		245AT/2245AT		245CT/2245CT		245DT		Unit
			Com.		Com.		Com.		Com.		
			Min.	Max.	Min.	Max.	Min.	Max.	Min.	Max.	
t <sub>PLH</sub>	Propagation Delay	C <sub>L</sub> = 50 pF R <sub>L</sub> = 500-ohm	1.5 <sup>(1)</sup>	7.0	1.5 <sup>(1)</sup>	4.6	1.5 <sup>(1)</sup>	4.1	1.5 <sup>(1)</sup>	3.8	ns
t <sub>PHL</sub>	A to B, B to A										
t <sub>PZH</sub>	Output Enable Time <sup>(2)</sup>										
t <sub>PZL</sub>	OE to A or B										
t <sub>PHZ</sub>	Output Disable Time <sup>(2)</sup>										
t <sub>PLZ</sub>	OE to A or B										
t <sub>PZH</sub>	Output Enable Time <sup>(2)</sup>										
t <sub>PZL</sub>	T/R to A or B										
t <sub>PHZ</sub>	Output Disable Time <sup>(2)</sup>										
t <sub>PLZ</sub>	T/R to A or B										

**Notes:**

1. Minimum limits are guaranteed but not tested on Propagation Delays.
2. This parameter is guaranteed but not production tested.

### Packaging Mechanical: 20-pin SOIC (S)

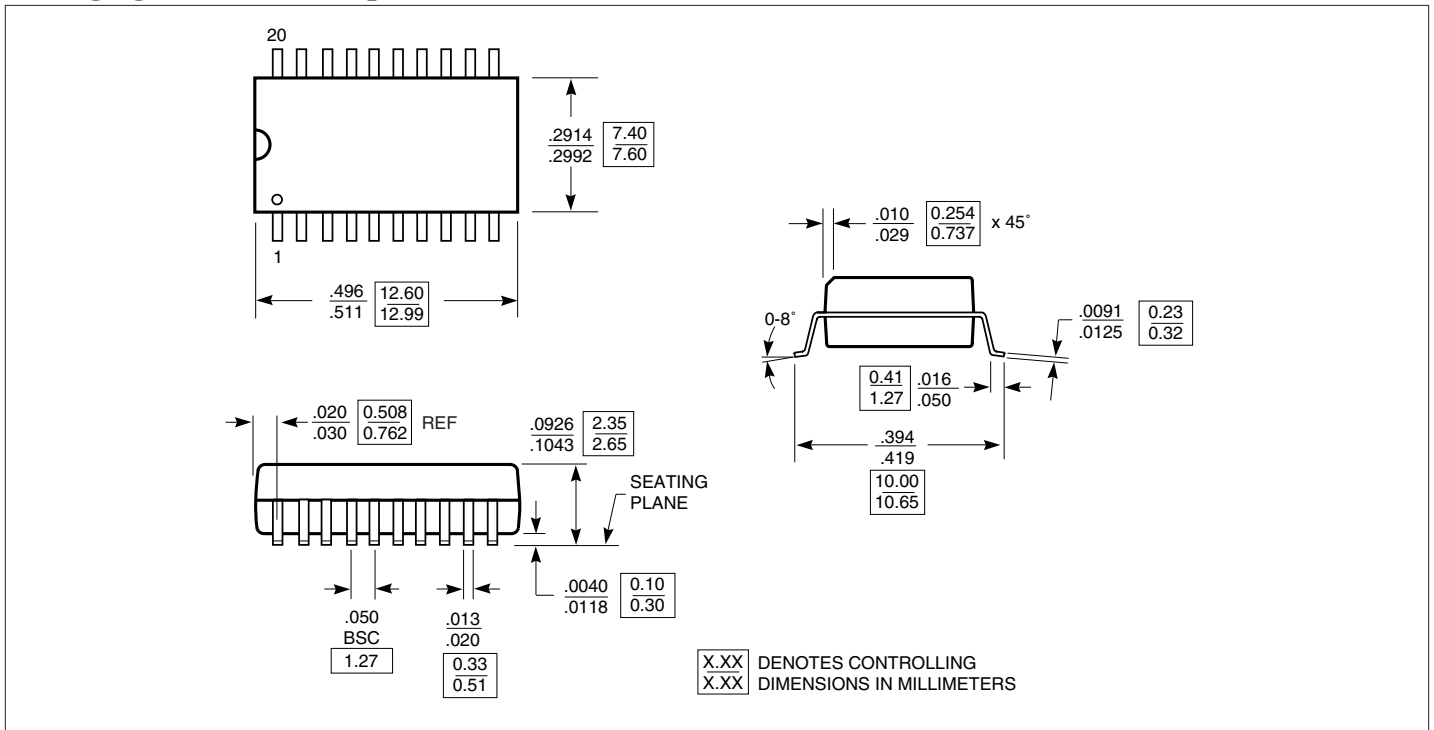

**Packaging Mechanical: 20-Pin TSSOP (L)**

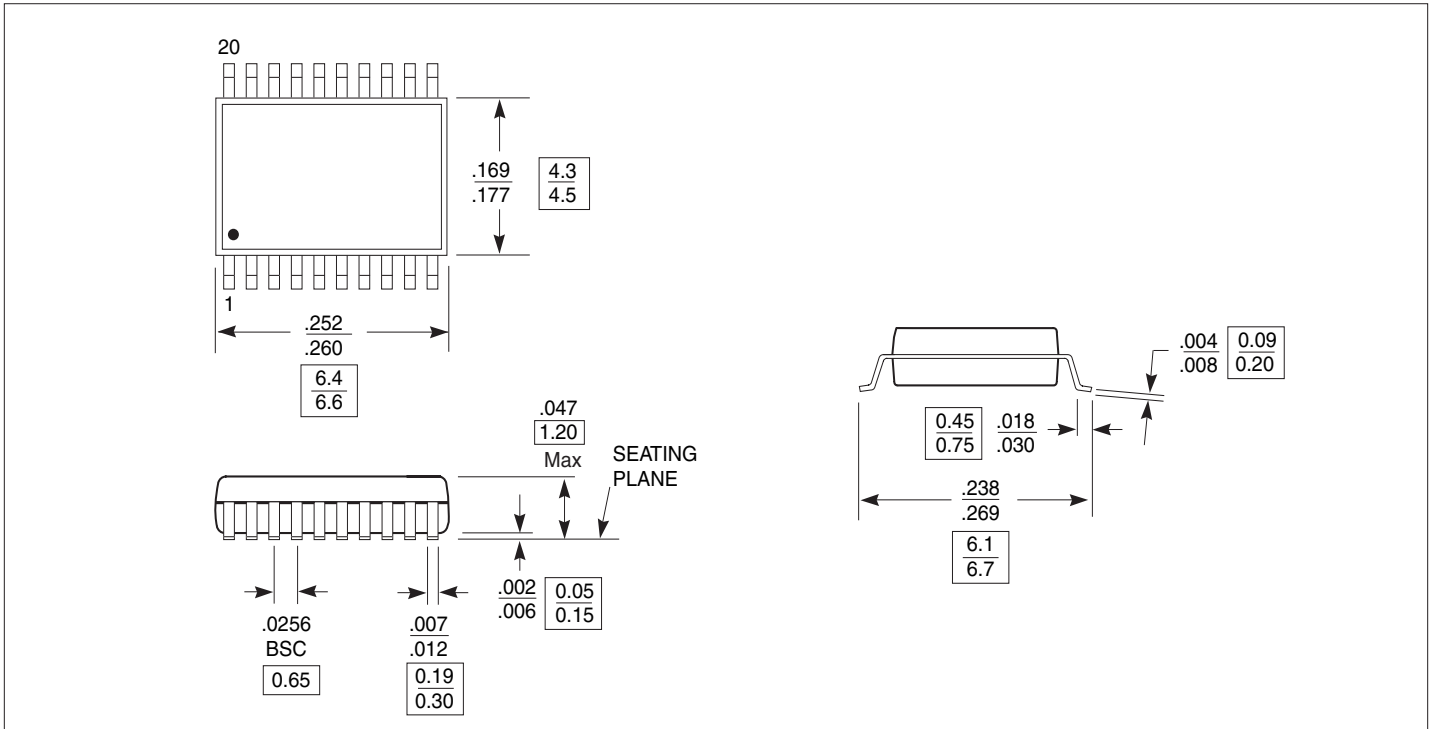

**Packaging Mechanical: 20-pin QSOP (Q)**

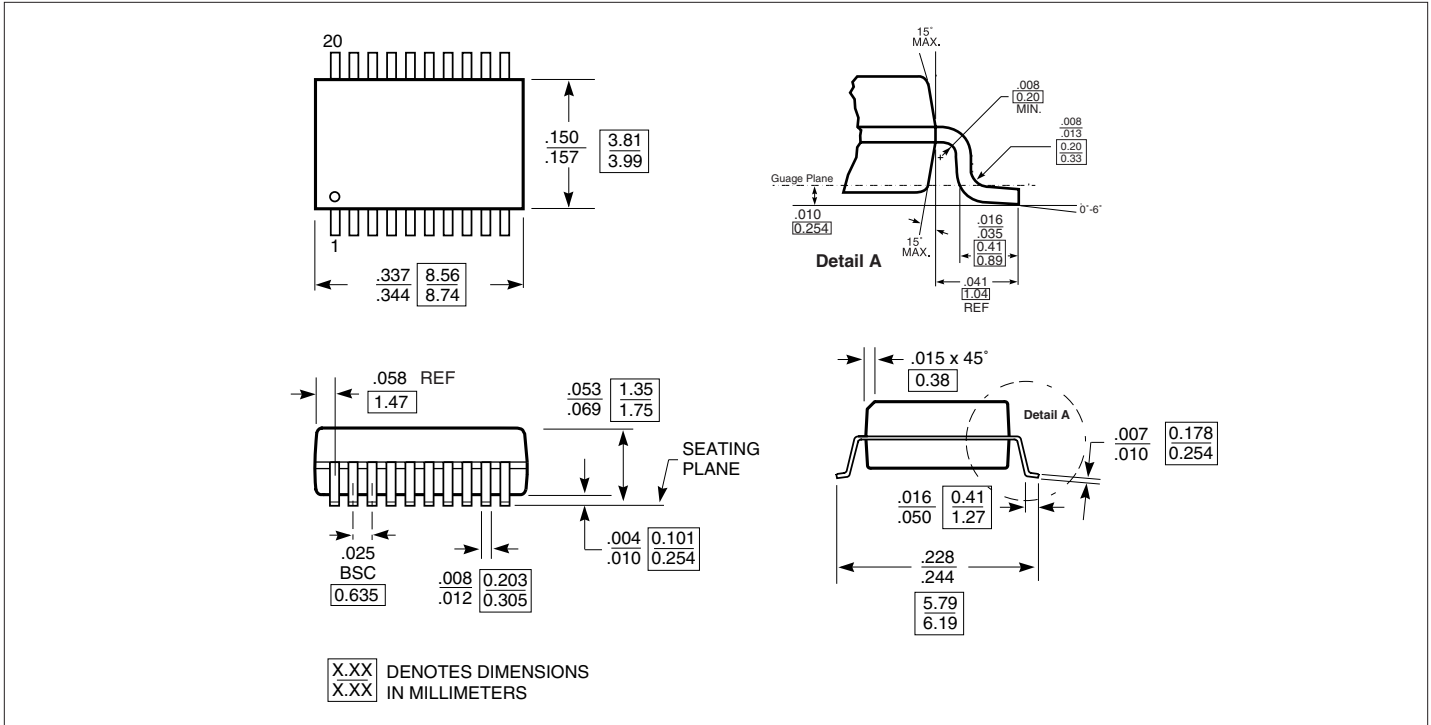

**Packaging Mechanical: 20-Pin SSOP (H)**

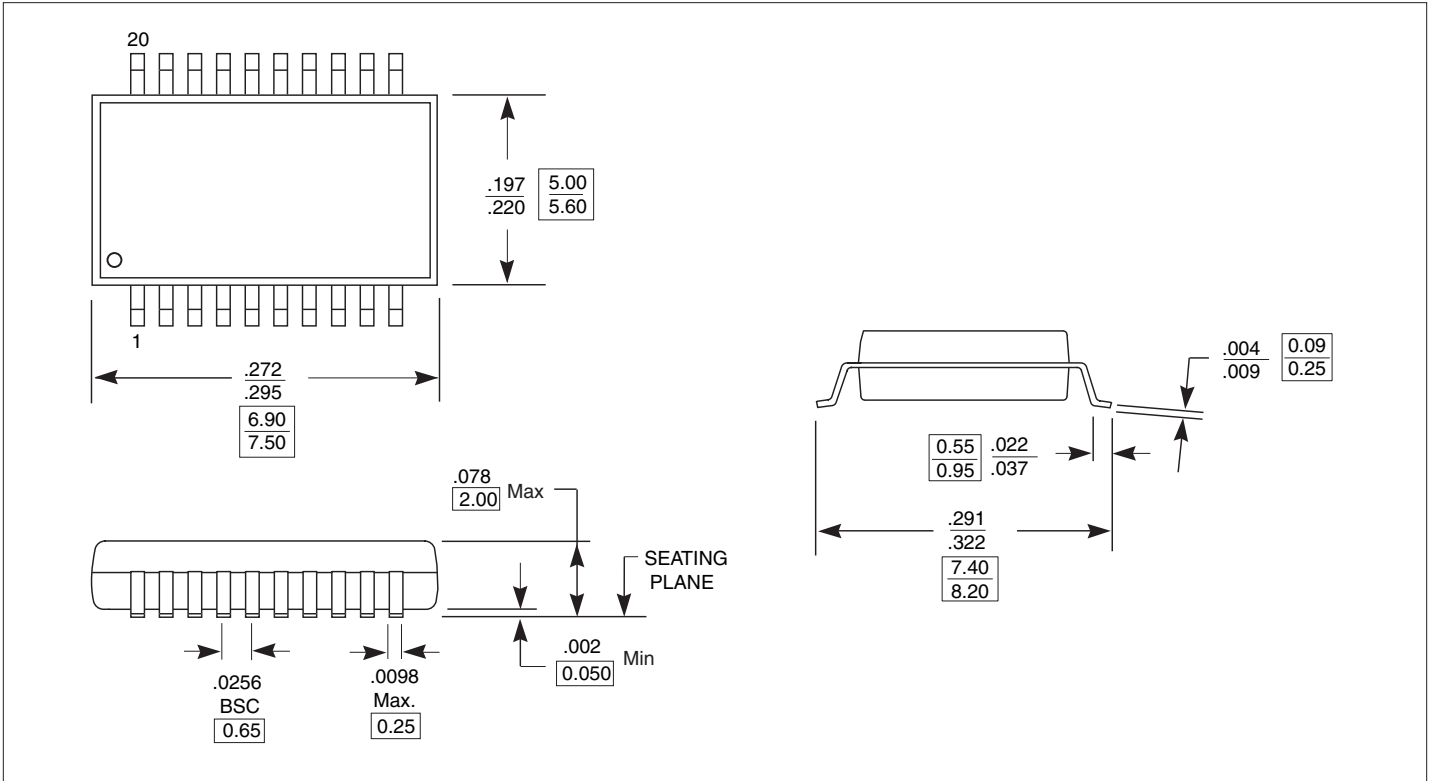

**PI74FCT245T Ordering Information**

Ordering Code	Package Code	Speed Grade	Package Type
PI74FCT245TQ	Q	Blank	20-pin QSOP
PI74FCT245TQE	Q	Blank	Pb-free & Green, 20-pin QSOP
PI74FCT245TS	S	Blank	20-pin SOIC
PI74FCT245TSE	S	Blank	Pb-free & Green, 20-pin SOIC
PI74FCT245ATLE	L	A	Pb-free & Green, 20-pin TSSOP
PI74FCT245ATS	S	A	20-pin SOIC
PI74FCT245ATSE	S	A	Pb-free & Green, 20-pin SOIC
PI74FCT245ATQ	Q	A	20-pin QSOP
PI74FCT245ATQE	Q	A	Pb-free & Green, 20-pin QSOP
PI74FCT245CTH	H	C	20-pin SSOP
PI74FCT245CTHE	H	C	Pb-free & Green, 20-pin SSOP
PI74FCT245CTS	S	C	20-pin SOIC
PI74FCT245CTSE	S	C	Pb-free & Green, 20-pin SOIC
PI74FCT245CTQ	Q	C	20-pin QSOP
PI74FCT245CTQE	Q	C	Pb-free & Green, 20-pin QSOP
PI74FCT245DTQ	Q	D	20-pin QSOP
PI74FCT245DTQE	Q	D	Pb-free & Green, 20-pin QSOP

### PI74FCT2245T Ordering Information

Ordering Code	Package Code	Speed Grade	Package Type
PI74FCT2245TQ	Q	Blank	20-pin QSOP
PI74FCT2245TQE	Q	Blank	Pb-free & Green, 20-pin QSOP
PI74FCT2245TS	S	Blank	20-pin SOIC
PI74FCT2245TSE	S	Blank	Pb-free & Green, 20-pin SOIC
PI74FCT2245ATS	S	A	20-pin SOIC
PI74FCT2245ATSE	S	A	Pb-free & Green, 20-pin SOIC
PI74FCT2245ATQ	Q	A	20-pin QSOP
PI74FCT2245ATQE	Q	A	Pb-free & Green, 20-pin QSOP
PI74FCT2245CTL	L	C	20-pin TSSOP
PI74FCT2245CTLE	L	C	Pb-free & Green, 20-pin TSSOP
PI74FCT2245CTQ	Q	C	20-pin QSOP
PI74FCT2245CTQE	Q	C	Pb-free & Green, 20-pin QSOP
PI74FCT2245DTSE	S	D	Pb-free & Green, 20-pin SOIC

**Notes:**

- Thermal characteristics can be found on the company web site at [www.pericom.com/packaging/](http://www.pericom.com/packaging/)
- E = Pb-free & Green
- Adding an X suffix = Tape/Reel

**Part Marking Information**

Pericom's standard product mark follows our standard part number ordering information, except for those products with a speed letter code. For marking purposes, the speed letter code mark is placed after the package code letter, rather than after the device number as it is ordered.

Although all products are marked immediately after assembly to assure material traceability, Pericom does not usually mark the speed code at that time. After electrical test screening and speed binning have been completed, we then perform an "add mark" operation which places the speed code letter at the end of the complete part number.

Please refer to the example shown below:

- Part Number as ordered: PI74FCT245ATQ
- Example of Part Number as marked:

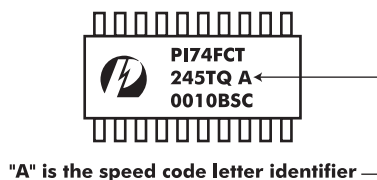

**Notes:**

- 1) 8-pin DIP, 8-pin SOIC, 8-pin TSSOP, 14-pin SOIC, 16-pin QSOP, SC70, MSOP, and SOT23 packages are not marked with the Pericom logo due to space limitations on the package.

# Mouser Electronics

Authorized Distributor

Click to View Pricing, Inventory, Delivery & Lifecycle Information:

## Pericom:

[PI74FCT245TQE](#) [PI74FCT245TQEX](#) [PI74FCT245TSE](#) [PI74FCT245TSEX](#) [PI74FCT245ATQE](#) [PI74FCT2245ATQE](#)  
[PI74FCT245CTQE](#) [PI74FCT2245CTQE](#) [PI74FCT245DTQE](#) [PI74FCT245ATQEX](#) [PI74FCT2245ATQEX](#)  
[PI74FCT245CTSEX](#) [PI74FCT2245ATSEX](#) [PI74FCT2245TSEX](#) [PI74FCT245ATSE](#) [PI74FCT245DTQEX](#)  
[PI74FCT2245CTQEX](#) [PI74FCT245CTSE](#) [PI74FCT2245TSE](#) [PI74FCT2245ATSE](#) [PI74FCT245ATSEX](#)