

SWITCHING APPLICATION.
INTERFACE CIRCUIT AND DRIVER CIRCUIT APPLICATION.

FEATURES

- With Built-in Bias Resistors
- Simplify Circuit Design
- Reduce a Quantity of Parts and Manufacturing Process
- High Packing Density.

EQUIVALENT CIRCUIT

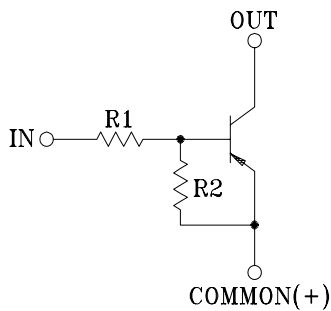

BIAS RESISTOR VALUES

TYPE NO.	R1(k Ω)	R2(k Ω)
KRA307	10	47
KRA308	22	47
KRA309	47	22

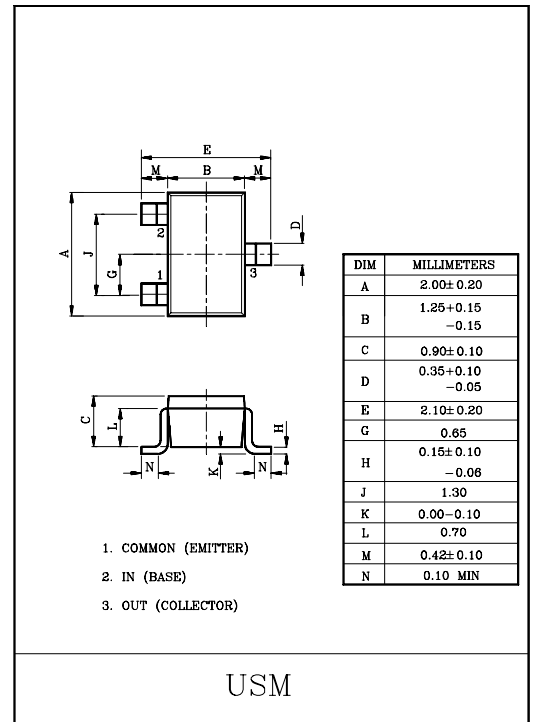

MAXIMUM RATINGS(T_a=25°C)

CHARACTERISTIC		SYMBOL	RATING	UNIT
Output Voltage	KRA307~309	V _O	-50	V
Input Voltage	KRA307	V _I	-30, 6	V
	KRA308		-40, 7	
	KRA309		-40, 15	
Output Current	KRA307~309	I _O	-100	mA
Power Dissipation		P _D	100	mW
Junction Temperature		T _j	150	°C
Storage Temperature Range		T _{stg}	-55~150	°C

MARK SPEC

TYPE	KRA307	KRA308	KRA309
MARK	PH	PI	PJ

Marking Type Name

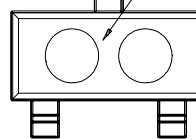

KRA307 ~ KRA309

ELECTRICAL CHARACTERISTICS (Ta=25°C)

CHARACTERISTIC		SYMBOL	TEST CONDITION	MIN.	TYP.	MAX.	UNIT		
Output Cut-off Current		KRA307~309	$I_{O(OFF)}$	$V_0=-50V, V_I=0$	-	-	-500	nA	
DC Current Gain	KRA307	G_I	$V_0=-5V, I_0=-10mA$	80	150	-			
	KRA308			80	150	-			
	KRA309			70	140	-			
Output Voltage		KRA307~309	$V_{O(ON)}$	$I_0=-10mA, I_f=-0.5mA$	-	-0.1	-0.3	V	
Input Voltage (ON)	KRA307	$V_{I(ON)}$	$V_0=-0.2V, I_0=-5mA$	-	-1.2	-1.8	V		
	KRA308			-	-1.8	-2.6			
	KRA309			-	-3.0	-5.8			
Input Voltage (OFF)	KRA307	$V_{I(OFF)}$	$V_0=-5V, I_0=-0.1mA$	-0.5	-0.75	-	V		
	KRA308			-0.6	-0.88	-			
	KRA309			-1.5	-1.82	-			
Transition Frequency		KRA307~309	$f_T *$	$V_0=-10V, I_0=-5mA$	-	200	-	MHz	
Input Current	KRA307	I_f	$V_I=-5V$	-	-	-0.88	mA		
	KRA308			-	-	-0.36			
	KRA309			-	-	-0.16			
Switching Time	Rise Time	KRA307	t_r	$V_0=-5V, V_{IN}=-5V$ $R_L=1k\Omega$	-	0.07	-	μS	
		KRA308			-	0.20	-		
		KRA309			-	0.38	-		
	Storage Time	KRA307			t_{stg}	-	1.1		-
		KRA308			-	1.3	-		
		KRA309			-	0.7	-		
	Fall Time	KRA307			t_f	-	0.35		-
		KRA308				-	0.4		-
		KRA309				-	0.48		-

Note : *Characteristic of Transistor Only

KRA307 ~ KRA309

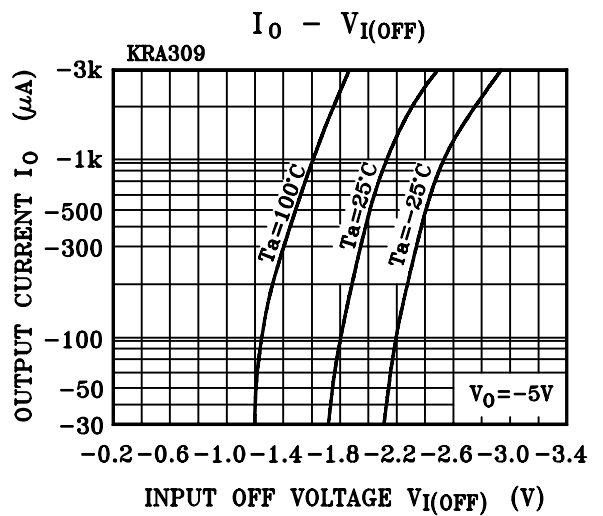
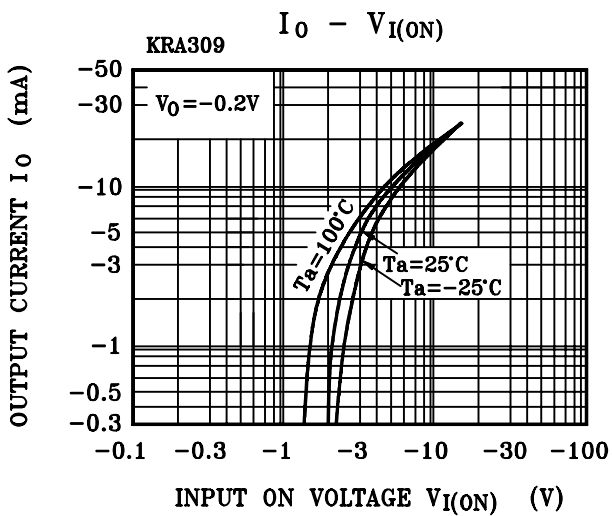
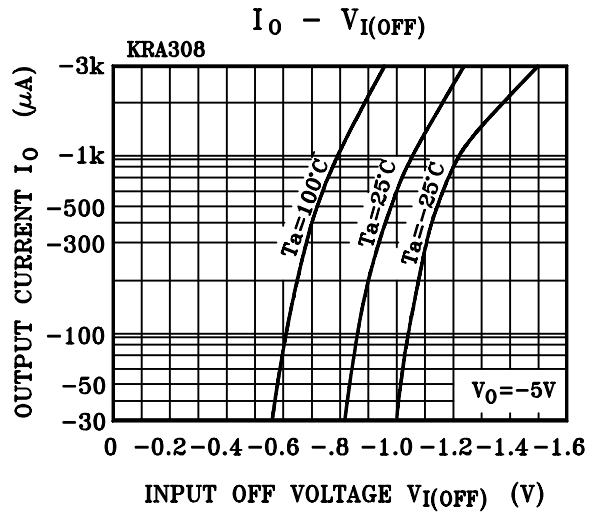
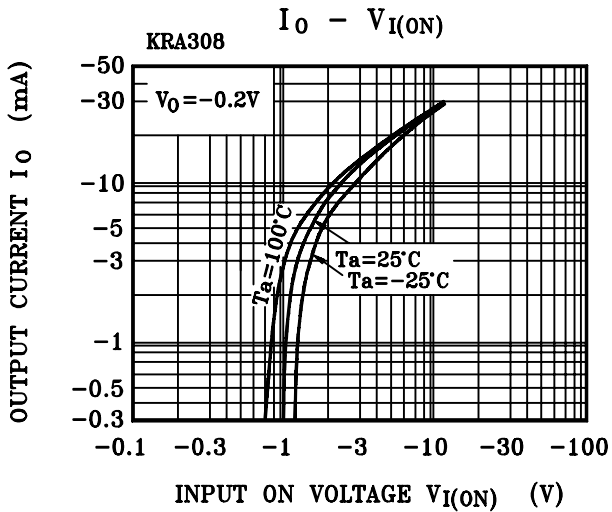
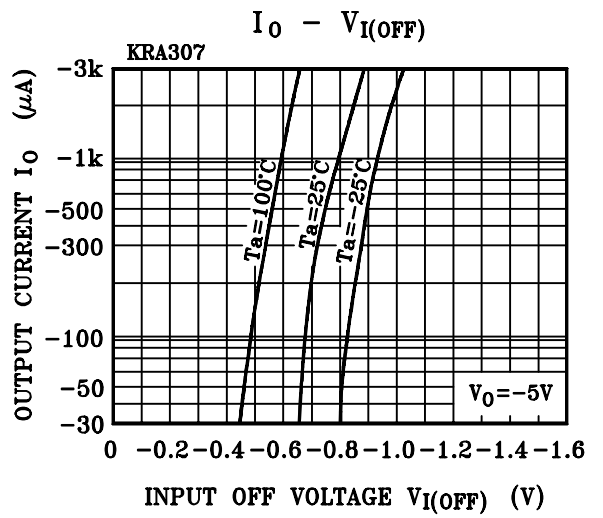
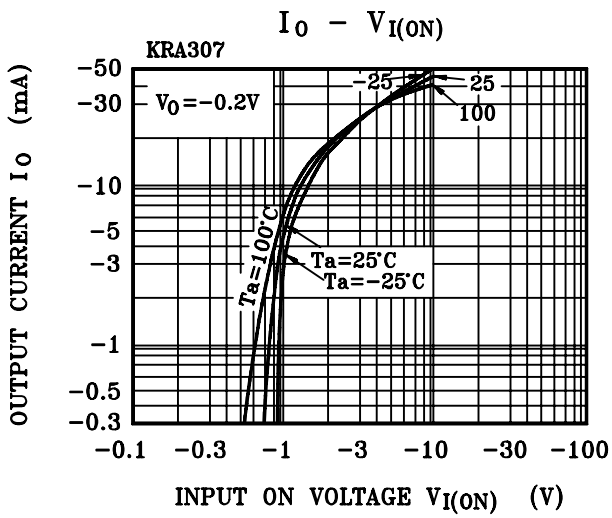

KRA307 ~ KRA309

