

TPS56623x 3-V to 18-V Input, 6-A Synchronous Step-Down Voltage Regulator

1 Features

- Configured for rugged applications
 - 3-V to 18-V input voltage range
 - 0.6-V to 7-V output voltage range
 - 6-A continuous output current
 - 0.6-V $\pm 1\%$ reference voltage (25°C)
 - 98% maximum duty cycle
 - 600-kHz switching frequency
 - Non-latched for OC, OV, UV, and OT protections
 - Built-in output discharge function
- Numerous pin-compatible options
 - TPS566231 and TPS566238 with SS pin for adjustable soft-start time
 - TPS566231P and TPS566238P with PG pin for power-good indicator
 - TPS566231 and TPS566231P for auto-skip mode
 - TPS566238 and TPS566238P for continuous current mode
- [Mandarin data sheet available](#)
- Small design size and ease of use
 - Integrated power MOSFET with $R_{DS(on)}$ 20.8 m Ω and 10.6 m Ω
 - D-CAP3™ control mode for fast transient response and internal compensation
 - 1.5-mm \times 2.0-mm HotRod™ QFN package
 - Create a custom design with the [WEBENCH® Power Designer](#)

2 Applications

- [Digital TV, set-top box, gaming consoles](#)
- [Server, storage and networking point-of-load](#)
- [Industrial PC, IP camera, and factory automation applications](#)

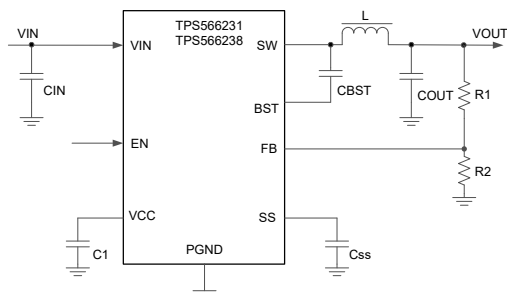

Typical Application

3 Description

The TPS56623x are simple, easy-to-use, high-efficiency, 6-A synchronous buck converters in a QFN 9-pin 1.5-mm \times 2.0-mm package.

The devices operate with wider supply input voltage ranging from 3 V to 18 V. The D-CAP3 control mode is adopted to provide a fast transient response, good line and load regulation, no requirement for external compensation, and support to low-ESR output capacitors.

The TPS566231 and TPS566231P operate in Eco-mode for high efficiency during light load operation. The devices are designed as the ULQ™ DC/DC converter, achieving 50- μ A quiescent current to enable long battery life in low-power applications. The TPS566238 and TPS566238P operate in continuous current mode, which maintains lower output ripple during all load conditions.

The TPS566231 and TPS566238 soft-start time can be adjusted through the SS pin. The TPS566231P and TPS566238P indicate power good through the PG pin.

The TPS56623x can support up to 98% duty cycle operation, and integrate complete protection through OVP, OCP, UVLO, OTP, and UVP with hiccup. The devices are each available in a 9-pin 1.5-mm \times 2.0-mm HotRod package. The junction temperature is specified from -40°C to 125°C .

Device Information

PART NUMBER	LIGHT LOAD MODE	PIN-9 DEFINITION
TPS566231	Auto-skip mode	Soft-start pin
TPS566238	Continuous current mode	Soft-start pin
TPS566231P	Auto-skip mode	Power-good pin
TPS566238P	Continuous current mode	Power-good pin

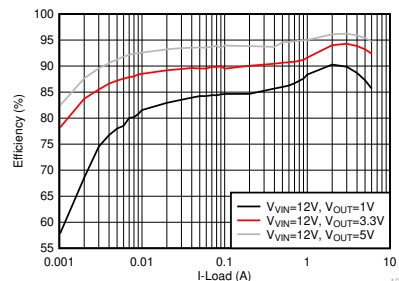

TPS566231 Efficiency vs Output Current



Table of Contents

1 Features	1	7 Application and Implementation	15
2 Applications	1	7.1 Application Information.....	15
3 Description	1	7.2 Typical Application.....	15
4 Pin Configuration and Functions	3	7.3 Power Supply Recommendations.....	21
5 Specifications	4	7.4 Layout.....	22
5.1 Absolute Maximum Ratings.....	4	8 Device and Documentation Support	23
5.2 ESD Ratings.....	4	8.1 Device Support.....	23
5.3 Recommended Operating Conditions.....	4	8.2 Receiving Notification of Documentation Updates.....	23
5.4 Thermal Information.....	5	8.3 Support Resources.....	23
5.5 Electrical Characteristics.....	5	8.4 Trademarks.....	23
5.6 Typical Characteristics.....	7	8.5 Electrostatic Discharge Caution.....	23
6 Detailed Description	11	8.6 Glossary.....	23
6.1 Overview.....	11	9 Revision History	24
6.2 Functional Block Diagram.....	11	10 Mechanical, Packaging, and Orderable Information	25
6.3 Feature Description.....	12		
6.4 Device Functional Modes.....	14		

4 Pin Configuration and Functions

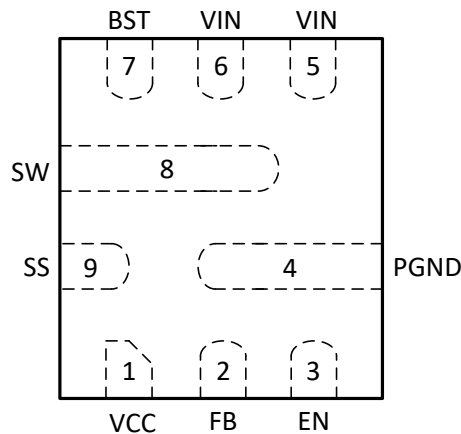

Figure 4-1. TPS566231, TPS566238 9-Pin RQF, VQFN-HR Package (Top View)

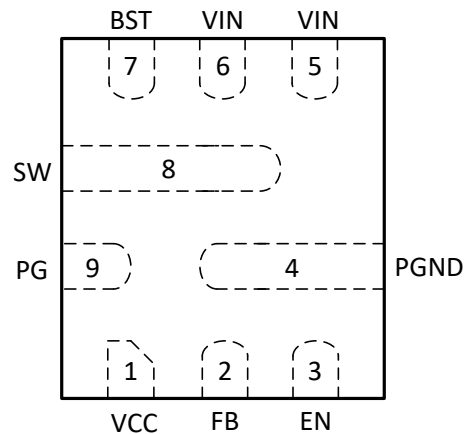

Figure 4-2. TPS566231P, TPS566238P 9-Pin RQF, VQFN-HR Package (Top View)

Table 4-1. Pin Functions

PIN		TYPE	DESCRIPTION
NAME	NO.		
VCC	1	O	5.0-V internal VCC LDO output. This pin supplies voltage to the internal circuitry and gate driver. Bypass this pin with a 1- μ F capacitor. If V_{VIN} is lower than 5 V, VCC follows the V_{IN} voltage.
FB	2	I	Converter feedback input. Connect to the center tap of the resistor divider between output voltage and ground.
EN	3	I	Enable pin of buck converter. The EN pin is a digital input pin, so the pin decides to turn on or turn off the buck converter. If the EN pin is open, the internal pullup current occurs to enable converter.
PGND	4	G	Ground pin. Power ground return for the switching circuit. Connect sensitive SS and FB returns to PGND at a single point.
VIN	5, 6	P	Input voltage supply pin. Connect the input decoupling capacitors between VIN and PGND.
BST	7	O	Supply input for the gate drive voltage of the high-side MOSFET. Connect the bootstrap capacitor between BST and SW. TI recommends 0.1 μ F.
SW	8	O	Switch node terminal. Connect the output inductor to this pin.
SS/PG	9	O	TPS566231 and TPS566238 soft-start control pin. Connecting an external capacitor sets the soft-start time.
		O	TPS566231P and TPS566238P open-drain power good indicator. This pin is asserted low if output voltage is out of PG threshold, over voltage, or if the device is under thermal shutdown, EN shutdown, or during soft start.

5 Specifications

5.1 Absolute Maximum Ratings

over operating free-air temperature range (unless otherwise noted)⁽¹⁾

			MIN	MAX	UNIT
Input voltage	VIN		-0.3	20	V
	BST		-0.3	26	V
	BST (10-ns transient)		-0.3	28	V
	BST-SW		-0.3	7	V
	VIN-SW			22	V
	VIN-SW (10-ns transient)			25.5	V
	SS, FB, EN, PG		-0.3	6	V
	PGND		-0.3	0.3	V
Output voltage	SW		-2	20	V
	SW (10-ns transient)		-5.5	22	V
	VCC		-0.3	6	V
T _J	Operating junction temperature		-40	150	°C
T _{stg}	Storage temperature		-55	150	°C

- (1) Stresses beyond those listed under *Absolute Maximum Rating* may cause permanent damage to the device. These are stress ratings only, which do not imply functional operation of the device at these or any other conditions beyond those indicated under *Recommended Operating Condition*. Exposure to absolute-maximum-rated conditions for extended periods may affect device reliability.

5.2 ESD Ratings

			VALUE	UNIT
V _(ESD)	Electrostatic discharge	Human-body model (HBM), per ANSI/ESDA/JEDEC JS-001 ⁽¹⁾	±2000	V
		Charged-device model (CDM), per ANSI/ESDA/JEDEC JS-002 ⁽²⁾	±500	

- (1) JEDEC document JEP155 states that 500-V HBM allows safe manufacturing with a standard ESD control process.
 (2) JEDEC document JEP157 states that 250-V CDM allows safe manufacturing with a standard ESD control process.

5.3 Recommended Operating Conditions

over operating free-air temperature range (unless otherwise noted)

			MIN	MAX	UNIT
Input voltage	VIN		3	18	V
	BST		-0.1	23.5	V
	BST-SW		-0.1	5.5	V
	SS, FB, EN, PG		-0.1	5.5	V
	PGND		-0.1	0.1	V
	Output voltage	SW		-1	18
VCC			-0.1	5.5	V
I _{OUT}	Output current		0	6	A
T _J	Operating junction temperature		-40	125	°C

5.4 Thermal Information

THERMAL METRIC ⁽¹⁾		TPS566231/8, TPS5662381P/8P		UNIT
		RQF(VQFN)		
		9 PINS		
R _{θJA}	Junction-to-ambient thermal resistance	89.6		°C/W
R _{θJA_effective}	Junction-to-ambient thermal resistance with TI EVM	44		°C/W
R _{θJC(top)}	Junction-to-case (top) thermal resistance	72.2		°C/W
R _{θJB}	Junction-to-board thermal resistance	25		°C/W
Ψ _{JT}	Junction-to-top characterization parameter	2.2		°C/W
Ψ _{JB}	Junction-to-board characterization parameter	24.8		°C/W
R _{θJC(bot)}	Junction-to-case (bottom) thermal resistance	NA		°C/W

(1) For more information about traditional and new thermal metrics, see the [Semiconductor and IC Package Thermal Metrics](#) application report.

5.5 Electrical Characteristics

T_J = -40°C to 125°C, V_{IN} = 12 V (unless otherwise noted)

PARAMETER		TEST CONDITIONS	MIN	TYP	MAX	UNIT
INPUT SUPPLY VOLTAGE						
V _{IN}	Input voltage range	V _{IN}	3		18	V
I _{VIN}	V _{IN} supply current	No load, V _{EN} = 5V, non-switching (TPS566231/1P)	25	50	75	μA
		No load, V _{EN} = 5V, non-switching (TPS566238/8P)	275	375	475	μA
I _{INSDN}	V _{IN} shutdown current	No load, V _{EN} = 0V		3.2	5	μA
UVLO						
V _{UVLOVIN}	VIN UVLO threshold	Wake up VIN voltage	2.62	2.74	2.86	V
		Shut down VIN voltage	2.44	2.54	2.64	V
		Hysteresis VIN voltage		200		mV
VCC OUTPUT						
V _{CC}	VCC output voltage	V _{IN} = 12V	4.7	5	5.2	V
		V _{IN} = 3V		3		V
I _{CC}	VCC current limit	V _{IN} = 12V	20			mA
		V _{IN} = 3V	5			mA
FEEDBACK VOLTAGE						
V _{FB}	FB voltage	T _J = 25°C	594	600	606	mV
		T _J = -40°C to 125°C	591	600	609	mV
MOSFET						
R _{DS(ON)HI}	High-side MOSFET R _{ds(on)}	T _J = 25°C, V _{IN} ≥ 5V		20.8		mΩ
		T _J = 25°C, V _{IN} = 3V		25.8		mΩ
R _{DS(ON)LO}	Low-side MOSFET R _{ds(on)}	T _J = 25°C, V _{IN} ≥ 5V		10.6		mΩ
		T _J = 25°C, V _{IN} = 3V		13		mΩ
I _{OCL}	Over current threshold	Valley current set point	6.1	7.4	8.9	A
I _{NOCL}	Negative over current threshold		2	3.4	5.3	A
DUTY CYCLE and FREQUENCY CONTROL						
F _{SW}	Switching frequency	T _J = 25°C, V _{VOU} T = 1.0V		600		kHz
T _{ON(MIN)}	Minimum on-time ⁽¹⁾	T _J = 25°C		50	90	ns
T _{OFF(MIN)}	Minimum off-time ⁽¹⁾	V _{FB} = 0.5V		100		ns

5.5 Electrical Characteristics (continued)

$T_J = -40^{\circ}\text{C}$ to 125°C , $V_{IN}=12\text{ V}$ (unless otherwise noted)

PARAMETER		TEST CONDITIONS	MIN	TYP	MAX	UNIT
LOGIC THRESHOLD						
$V_{EN(ON)}$	EN threshold high-level		1.13	1.19	1.25	V
$V_{EN(OFF)}$	EN threshold low-level		1.01	1.08	1.16	V
V_{ENHYS}	EN hysteresis			110		mV
I_{EN}	EN pullup current	$V_{EN} = 1.0\text{V}$		2		μA
OUTPUT DISCHARGE and SOFT START						
R_{DIS}	Discharge resistance	$T_J = 25^{\circ}\text{C}$, $V_{OUT} = 0.5\text{V}$, $V_{EN} = 0\text{V}$		114		Ω
I_{SS}	Soft-start charge current	TPS566231/TPS566238	5	6.5	8.5	μA
T_{SS}	Internal soft-start time	TPS566231P/TPS566238P	0.93	1.9	2.9	ms
POWER GOOD (TPS566231P/TPS566238P)						
T_{PGDLY}	PG start-up delay	PG from low-to-high		1		ms
		PG from high-to-low		32		μs
V_{PGTH}	PG threshold	VFB falling (fault)	80	85	90	%
		VFB rising (good)	85	90	95	%
		VFB rising (fault)	110	115	120	%
		VFB falling (good)	105	110	115	%
V_{PG_L}	PG sink current capability	$I_{OL} = 4\text{mA}$			0.4	V
I_{PGLK}	PG leak current	$V_{PGOOD} = 5.5\text{V}$			1	μA
OUTPUT UNDERVOLTAGE AND OVERVOLTAGE PROTECTION						
V_{OVP}	OVP trip threshold		110	115	120	%
t_{OVPDLY}	OVP prop deglitch	$T_J = 25^{\circ}\text{C}$		32		μs
V_{UVP}	UVP trip threshold		55	60	65	%
t_{UVPDLY}	UVP prop deglitch			256		μs
t_{UVPDEL}	Output hiccup delay relative to SS time	UVP detect		256		μs
t_{UVPEN}	Output hiccup enable delay relative to SS time	UVP detect (TPS566231/TPS566238)		7		cycles
t_{UVPEN}	Output hiccup enable delay relative to SS time	UVP detect (TPS566231P/TPS566238P)		19		ms
THERMAL PROTECTION						
T_{OTP}	OTP trip threshold ⁽¹⁾			160		$^{\circ}\text{C}$
T_{OTPHSY}	OTP hysteresis ⁽¹⁾			25		$^{\circ}\text{C}$

(1) No production test, specified by design.

5.6 Typical Characteristics

$T_J = -40^{\circ}\text{C}$ to 125°C , $V_{IN} = 12\text{ V}$ (unless otherwise noted)

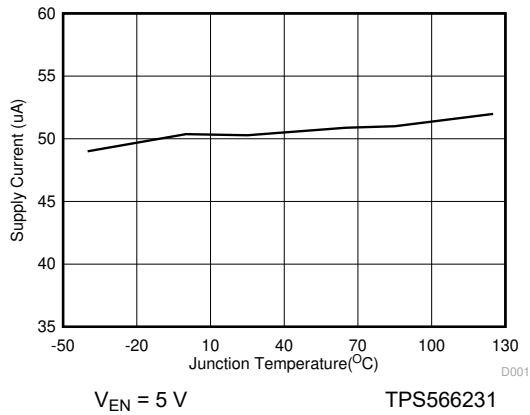

Figure 5-1. Supply Current vs Junction Temperature

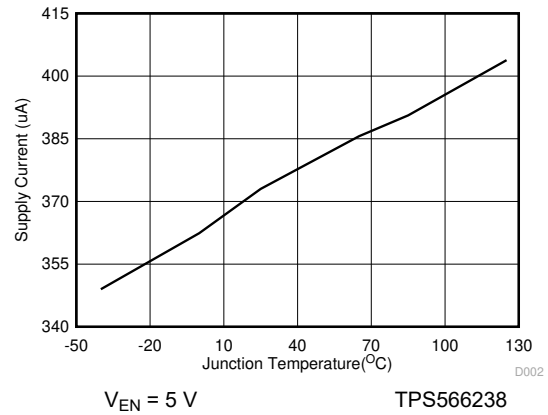

Figure 5-2. Supply Current vs Junction Temperature

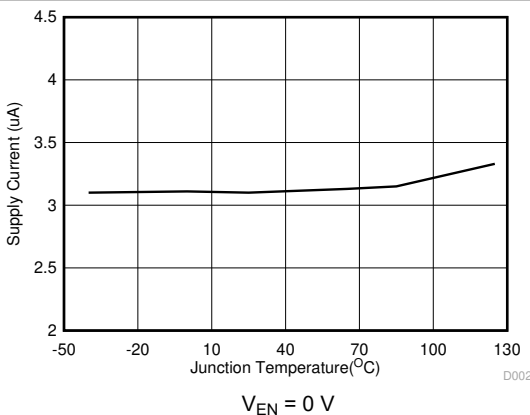

Figure 5-3. Shutdown Current vs Temperature

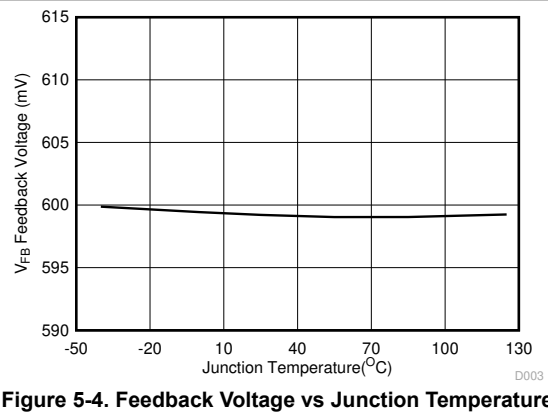

Figure 5-4. Feedback Voltage vs Junction Temperature

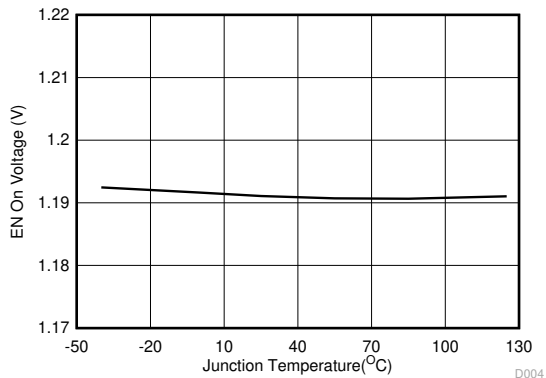

Figure 5-5. Enable-On Voltage vs Junction Temperature

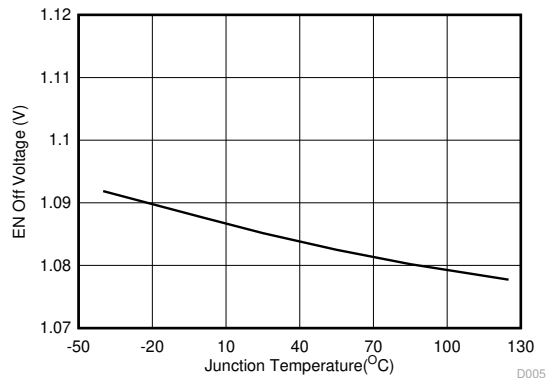

Figure 5-6. Enable-Off Voltage vs Junction Temperature

5.6 Typical Characteristics (continued)

$T_J = -40^{\circ}\text{C}$ to 125°C , $V_{IN} = 12\text{ V}$ (unless otherwise noted)

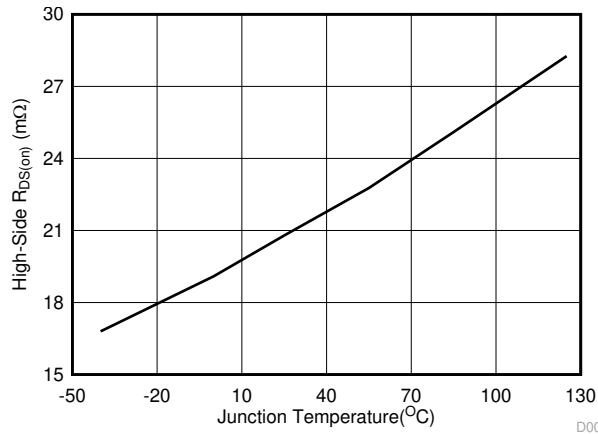

Figure 5-7. High-Side $R_{DS(on)}$ vs Junction Temperature

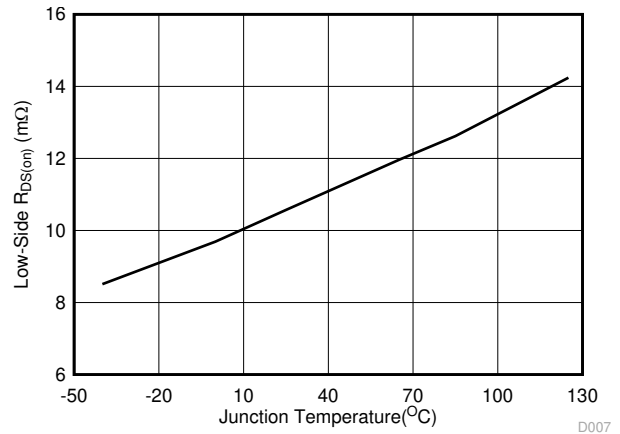

Figure 5-8. Low-Side $R_{DS(on)}$ vs Junction Temperature

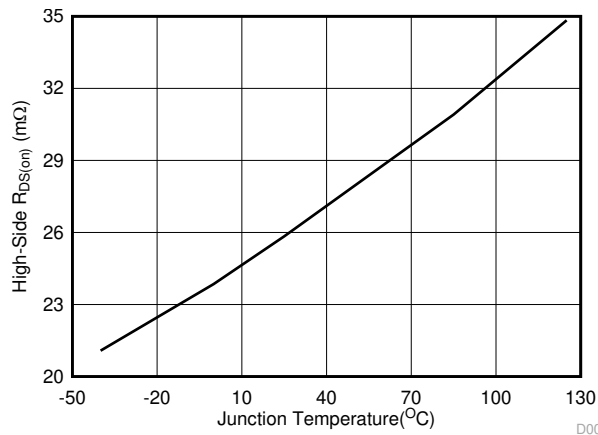

Figure 5-9. High-Side $R_{DS(on)}$ vs Junction Temperature

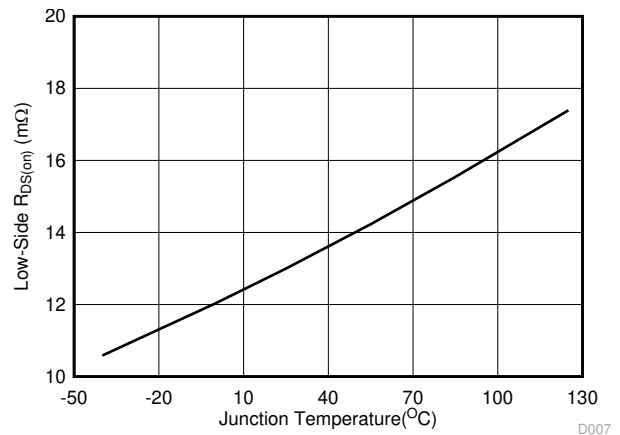

Figure 5-10. Low-Side $R_{DS(on)}$ vs Junction Temperature

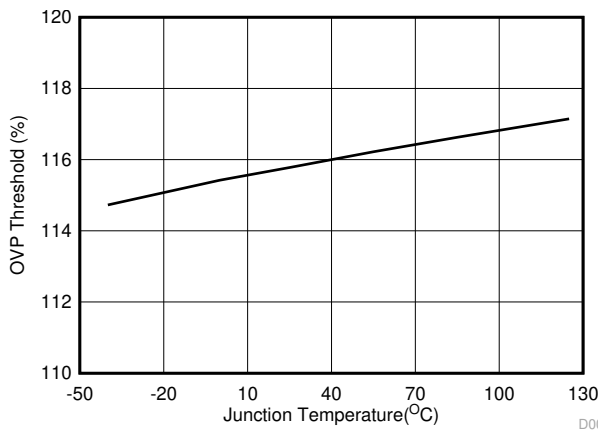

Figure 5-11. OVP Threshold vs Junction Temperature

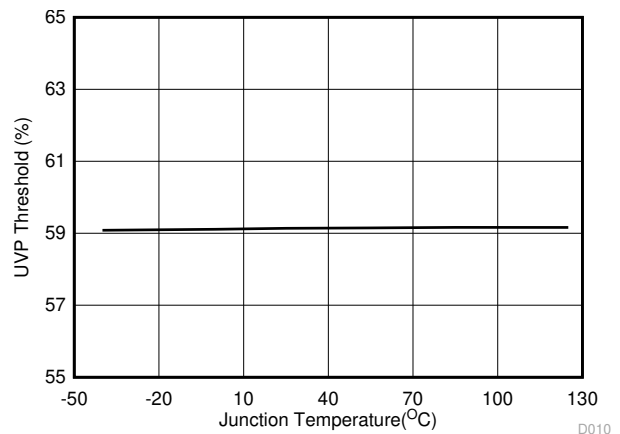

Figure 5-12. UVP Threshold vs Junction Temperature

5.6 Typical Characteristics (continued)

$T_J = -40^{\circ}\text{C}$ to 125°C , $V_{IN} = 12\text{ V}$ (unless otherwise noted)

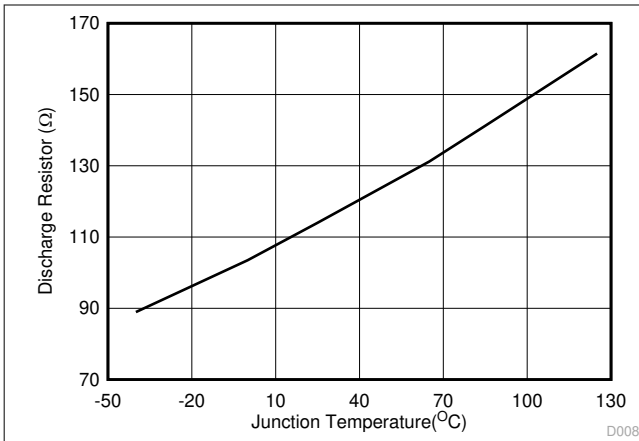

Figure 5-13. Discharge Resistor vs Junction Temperature

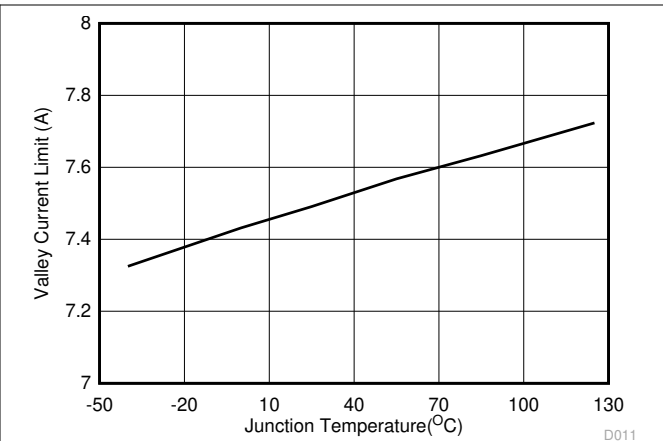
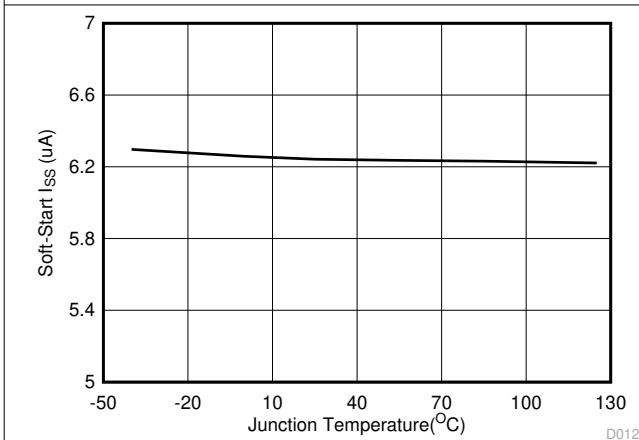
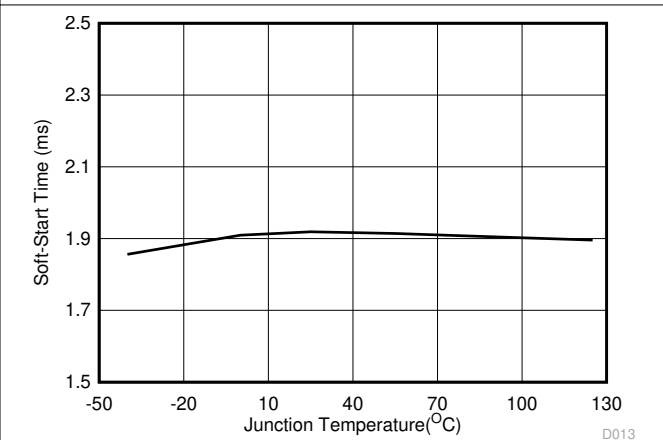

Figure 5-14. Valley Current Limit vs Junction Temperature



TPS566231 and TPS566238

Figure 5-15. Soft-Start Charge Current Iss vs Junction Temperature



TPS566231P and TPS566238P

Figure 5-16. Soft-Start Time vs Junction Temperature

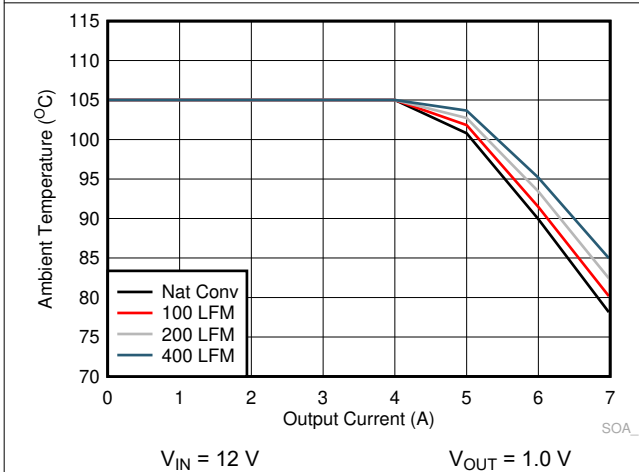

$V_{IN} = 12\text{ V}$ $V_{OUT} = 1.0\text{ V}$

Figure 5-17. Safe Operating Area

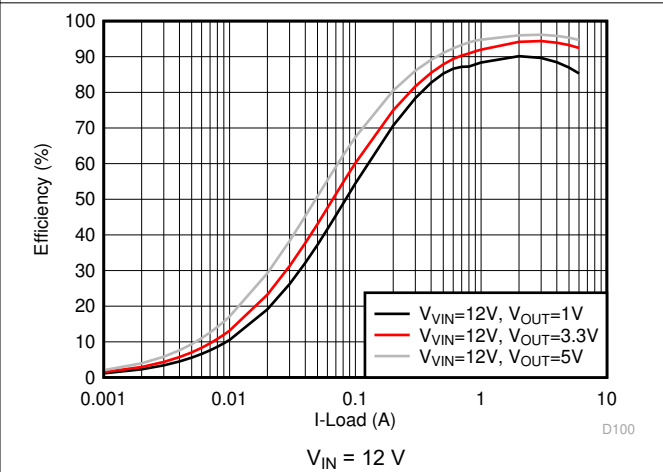

$V_{IN} = 12\text{ V}$

Figure 5-18. TPS566238 and TPS566238P Efficiency

5.6 Typical Characteristics (continued)

$T_J = -40^{\circ}\text{C}$ to 125°C , $V_{IN} = 12\text{ V}$ (unless otherwise noted)

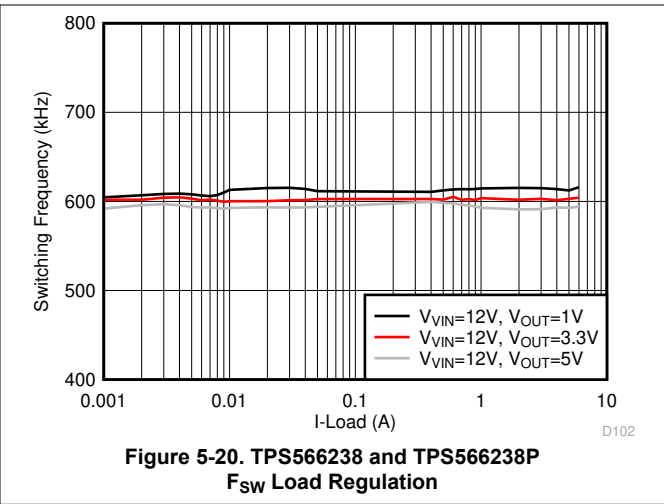
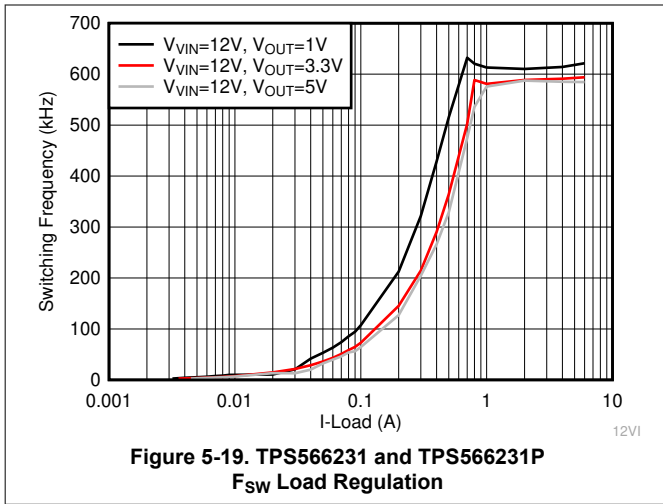

6 Detailed Description

6.1 Overview

The TPS56623x is a 6-A, integrated, FET, synchronous buck converter that operates from 3-V to 18-V input voltage (V_{IN}) and 0.6-V to 7-V output voltage. The proprietary D-CAP3 control mode enables low external component count, ease of design, and optimization of the power design for cost, size, and efficiency. As the ULQ™ DC/DC converter, the device enables long battery life in system standby mode and high efficiency under light load conditions. The devices employ D-CAP3 control mode that provides fast transient response with no external compensation components and an accurate feedback voltage. The control topology provides a seamless transition between CCM operating mode in heavier load conditions and DCM operation in lighter load conditions.

Eco-mode allows the TPS566231 and TPS566231P to maintain high efficiency at light load. The TPS566238 and TPS566238P work in continuous current mode to maintain lower output ripple in all load conditions. The soft-start time of the TPS566231 and TPS566238 can be adjusted through the SS pin. The TPS566231P and TPS566238P indicate power good through the PG pin. The devices are able to adapt to both low equivalent series resistance (ESR) output capacitors, such as POS-CAP or SP-CAP, and ultra-low ESR ceramic capacitors.

6.2 Functional Block Diagram

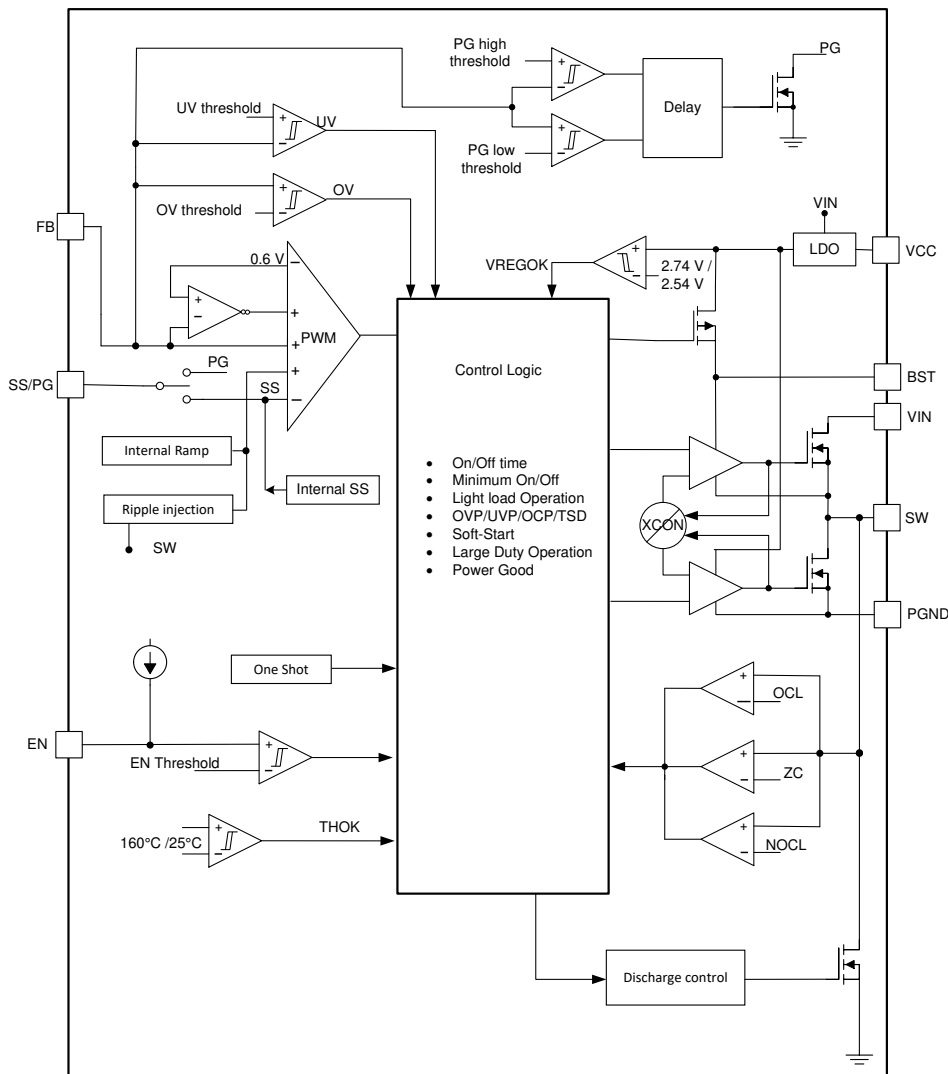

6.3 Feature Description

6.3.1 PWM Operation and D-CAP3™ Control Mode

The main control loop of the buck is an adaptive on-time pulse width modulation (PWM) controller that supports a proprietary D-CAP3 control mode. D-CAP3 control mode combines adaptive on-time control with an internal compensation circuit for pseudo-fixed frequency and low external component count configuration with both low-ESR and ceramic output capacitors. It is stable even with virtually no ripple at the output. The TPS56623x also includes an error amplifier that makes the output voltage very accurate.

At the beginning of each cycle, the high-side MOSFET is turned on. This MOSFET is turned off after an internal one-shot timer expires. This one-shot duration is set proportional to the output voltage, V_{OUT} , and is inversely proportional to the converter input voltage, V_{IN} . This is done to maintain a pseudo-fixed frequency over the input voltage range, hence it is called adaptive on-time control. The one-shot timer is reset and the high-side MOSFET is turned on again when the feedback voltage falls below the reference voltage. An internal ripple generation circuit is added to the reference voltage to emulate the output ripple. This enables the use of very low-ESR output capacitors such as multi-layered ceramic caps (MLCC). No external current sense network or loop compensation is required for D-CAP3 control mode.

For any control topology that is compensated internally, there is a range of the output filter it can support. The output filter used with the devices is a low-pass L-C circuit. This L-C filter has a double-pole frequency described in Equation 1.

$$f_p = \frac{1}{2 \times \pi \times \sqrt{L_{OUT} \times C_{OUT}}} \quad (1)$$

At low frequency, the overall loop gain is set by the output setpoint resistor divider network and the internal gain of the TPS56623x. The low-frequency L-C double pole has a 180 degree drop in-phase. At the output filter frequency, the gain rolls off at a –40-dB per decade rate and the phase drops rapidly. The internal ripple generation network introduces a high-frequency zero that reduces the gain rolloff from –40-dB to –20-dB per decade and leads the 90 degree phase boost. The internal ripple injection high-frequency zero is approximately 45 kHz. The inductor and capacitor selected for the output filter is recommended such that the double pole is located close to 1/3 the high-frequency zero. This is done so that the phase boost provided by this high-frequency zero provides adequate phase margin for the stability requirement. The crossover frequency of the overall system usually must be targeted to be less than one-third of the switching frequency (F_{SW}).

6.3.2 Soft Start

The TPS566231 and TPS566238 have an external SS pin to set the soft-start time. When the EN pin becomes high, the soft start function begins ramping up the reference voltage to the PWM comparator.

If the application needs a longer soft-start time than 0.5 ms, the time can be set by connecting a capacitor on the SS pin. When the EN pin becomes high, the soft-start charge current (I_{SS}) begins charging the external capacitor (C_{SS}) connected between SS and ground. The devices track the lower of the internal soft-start voltage or the external soft-start voltage as the reference. The estimated equation for the soft-start time (T_{SS}) is shown in Equation 2:

$$T_{ss}(ms) = \frac{1.4 \times C_{ss}(nF) \times V_{REF}(V)}{I_{ss}(\mu A)} \quad (2)$$

where

- V_{REF} is 0.6 V
- I_{SS} is 6.5 μ A

6.3.3 Power Good

The TPS566231P and TPS566238P have the PG pin as a power-good indicator. The PG pin is an open-drain output. After the V_{FB} is between 90% and 110% of the internal reference voltage (V_{REF}), the PG is de-asserted and floats after a 1-ms de-glitch time. TI recommends a 100-k Ω pullup resistor to pull the voltage up to VCC. The PG pin is pulled low when:

- The FB pin voltage is lower than 85% or greater than 115% of the target output voltage
- The device is in an OVP, UVP, or thermal shutdown event
- Or during the soft-start period

6.3.4 Large Duty Operation

The TPS56623x can support large duty operations by smoothly dropping down the switching frequency. When $V_{IN} / V_{OUT} < 1.6$ and the V_{FB} is lower than internal V_{REF} , the switching frequency is allowed to smoothly drop to make T_{ON} extended. This action is done to implement large duty operation and also improve the performance of the load transient performance. The minimum switching frequency is limited with about 165 kHz with typical 100-ns minimum off-time. The TPS56623x can support up to 98% duty cycle operation.

6.3.5 Overcurrent Protection and Undervoltage Protection

The TPS56623x has overcurrent protection and undervoltage protection. The output overcurrent limit (OCL) is implemented using a cycle-by-cycle valley detect circuit. The switch current is monitored during the OFF state by measuring the low-side FET drain-to-source voltage. This voltage is proportional to the switch current. To improve accuracy, the voltage sensing is temperature compensated.

During the on-time of the high-side FET switch, the switch current increases at a linear rate determined by the following:

- V_{IN}
- V_{OUT}
- the on-time
- the output inductor value

During the on-time of the low-side FET switch, this current decreases linearly. The average value of the switch current is the load current I_{OUT} . If the monitored current is above the OCL level, the converter maintains low-side FET on and delays the creation of a new set pulse. This is true even if the voltage feedback loop requires one, until the current level becomes OCL level or lower. In subsequent switching cycles, the on-time is set to a fixed value and the current is monitored in the same manner.

There are some important considerations for this type of overcurrent protection. When the load current is higher than the overcurrent threshold by one half of the peak-to-peak inductor ripple current, the OCL is triggered and the current is limited. The output voltage tends to drop because the load demand is higher than what the converter can support. When the output voltage falls below 60% of the target voltage, the UVP comparator detects it and the device shuts off after a 256- μ s wait time. The device then restarts after the hiccup time (typically $7 \times T_{SS}$). When the overcurrent condition is removed, the output is recovered.

6.3.6 Overvoltage Protection

The TPS56623x has the overvoltage protection feature. When the output voltage becomes higher than 115% of the target voltage, the OVP is triggered. The output is discharged after a 32- μ s wait time, and both the high-side and low-side MOSFET driver turn off. When the overvoltage condition is removed, the output voltage is recovered.

6.3.7 UVLO Protection

Undervoltage lockout protection (UVLO) monitors the V_{IN} power input. When the voltage is lower than UVLO threshold voltage, the device is shut off and output is discharged. This protection is a non-latch protection.

6.3.8 Output Voltage Discharge

The TPS56623x has the discharge function by using a 114-Ω $R_{DS(on)}$ internal MOSFET, which discharges the output V_{OUT} through the SW node during any event like the following occurs:

- Output overvoltage protection
- Output undervoltage protection
- TSD
- VCC voltage is below the UVLO
- EN pin voltage (V_{EN}) is below the turn-on threshold

The discharge is slow due to the lower current capability of the MOSFET.

6.3.9 Thermal Shutdown

The TPS56623x monitors the internal die temperature. If the temperature exceeds the threshold value (typically 160°C), the device is shut off and the output is discharged. This protection is a non-latched protection. The device restarts switching when the temperature goes below the thermal shutdown threshold.

6.4 Device Functional Modes

6.4.1 Advanced Eco-mode Control

The TPS566231 and TPS566231P operate in advanced Eco-mode mode, which maintains high light-load efficiency. As the output current decreases from heavy load conditions, the inductor current is also reduced and eventually the rippled valley touches zero level. This is the boundary between continuous conduction and discontinuous conduction modes. The rectifying MOSFET is turned off when the zero inductor current is detected. As the load current further decreases, the converter runs into discontinuous conduction mode. The on-time is kept almost the same as it was in continuous conduction mode so that it takes longer time to discharge the output capacitor with smaller load current to the level of the reference voltage. This makes the switching frequency lower, proportional to the load current, and keeps the light load efficiency high. Use [Equation 3](#) to calculate the light load current where the transition to Eco-mode operation happens ($I_{OUT(LL)}$).

$$I_{OUT(LL)} = \frac{1}{2 \times L_{OUT} \times F_{SW}} \times \frac{(V_{IN} - V_{OUT}) \times V_{OUT}}{V_{IN}} \quad (3)$$

After identifying the application requirements, design the output inductance (L_{OUT}) so that the inductor peak-to-peak ripple current is approximately 20% to 30% of $I_{OUT(max)}$ (peak current in the application). Make sure to size the inductor properly so that the valley current does not hit the negative low-side current limit.

6.4.2 Force CCM Mode

The TPS566238 and TPS566238P operate in Force CCM (FCCM) mode, which keeps the converter operating in continuous current mode during light-load conditions. FCCM allows the inductor current to become negative. During FCCM mode, the switching frequency (F_{SW}) is maintained at an almost constant level over the entire load range. This is an excellent choice for applications requiring tight control of the switching frequency and output voltage ripple at the cost of lower efficiency under light load.

6.4.3 Standby Operation

The TPS56623x can be placed in standby mode by pulling the EN pin low. The device operates with 3.2-μA shutdown current in standby condition. The EN pin is pulled high internally. When floating, the part is enabled by default.

7 Application and Implementation

Note

Information in the following applications sections is not part of the TI component specification, and TI does not warrant its accuracy or completeness. TI's customers are responsible for determining suitability of components for their purposes, as well as validating and testing their design implementation to confirm system functionality.

7.1 Application Information

The schematic in Figure 7-1 shows a typical application for the TPS566231 with 1-V output. This design converts an input voltage range of 3 V to 18 V down to 1 V with a maximum output current of 6 A.

7.2 Typical Application

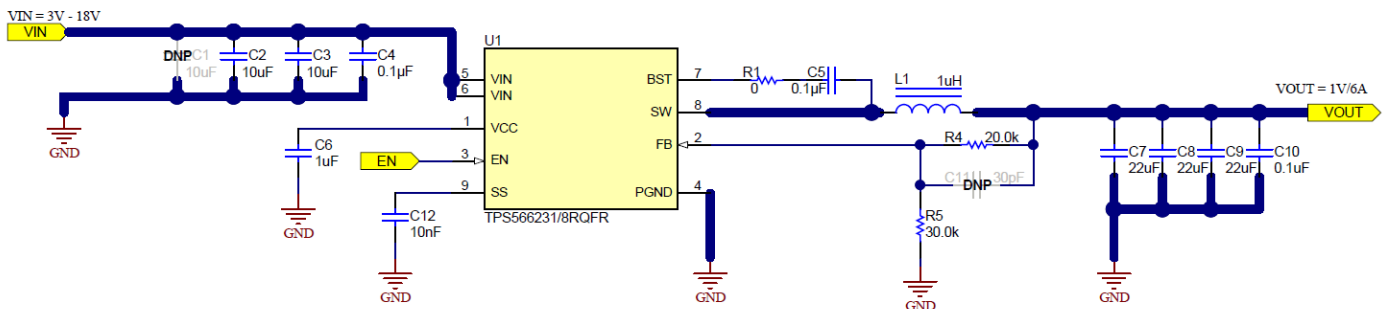

Figure 7-1. 1-V, 6-A Reference Design

7.2.1 Design Requirements

Table 7-1 lists the design parameters for this example.

Table 7-1. Design Parameters

PARAMETER	CONDITIONS	MIN	TYP	MAX	UNIT
V_{OUT}	Output voltage		1		V
I_{OUT}	Output current		6		A
ΔV_{OUT}	Transient response		±50		mV
V_{IN}	Input voltage	3	12	18	V
$V_{OUT(ripple)}$	Output voltage ripple		14		mV _(P-P)
F_{SW}	Switching frequency		600		kHz
T_A	Ambient temperature		25		°C

7.2.2 Detailed Design Procedure

7.2.2.1 Custom Design with WEBENCH® Tools

[Click here](#) to create a custom design using the TPS56623x device with the WEBENCH Power Designer.

1. Start by entering the input voltage (V_{IN}), output voltage (V_{OUT}), and output current (I_{OUT}) requirements.
2. Optimize the design for key parameters such as efficiency, footprint, and cost.
3. Compare the generated design with other possible solutions from Texas Instruments.

The WEBENCH Power Designer provides a customized schematic along with a list of materials with real-time pricing and component availability.

In most cases, these actions are available:

- Estimate IC thermal and efficiency performance

- Run electrical simulations to see important waveforms and circuit performance
- Export customized schematic and layout into popular CAD formats
- Print PDF reports for the design, and share the design with colleagues

Get more information about WEBENCH tools at www.ti.com/WEBENCH.

7.2.2.2 Output Voltage Setpoint

To change the output voltage of the application, changing the value of the upper feedback resistor is necessary. By changing this resistor, the user can change the output voltage above 0.6 V. See [Equation 4](#).

$$V_{OUT} = 0.6 \times \left(1 + \frac{R_{UPPER}}{R_{LOWER}}\right) \quad (4)$$

7.2.2.3 Inductor Selection

The inductor ripple current is filtered by the output capacitor. A higher inductor ripple current means the output capacitor must have a ripple current rating higher than the inductor ripple current. See [Table 7-2](#) for recommended inductor values.

The RMS and peak currents through the inductor can be calculated using [Equation 5](#) and [Equation 6](#). Make sure that the inductor is rated to handle these currents.

$$I_{L(RMS)} = \sqrt{I_{OUT}^2 + \frac{1}{12} \times \left(\frac{V_{OUT} \times (V_{IN(max)} - V_{OUT})}{V_{IN(max)} \times L_{OUT} \times F_{SW}} \right)^2} \quad (5)$$

$$I_{L(peak)} = I_{OUT} + \frac{I_{L(ripple)}}{2} \quad (6)$$

During transient and short-circuit conditions, the inductor current can increase up to the current limit of the device. This means that choosing an inductor with a saturation current higher than the peak current under current limit condition is safe.

7.2.2.4 Output Capacitor Selection

After selecting the inductor the output capacitor must be optimized. In D-CAP3 control mode, the regulator reacts within one cycle to the change in duty cycle so the good transient performance can be achieved without needing large amounts of output capacitance. The recommended output capacitance range is given in [Table 7-2](#). Please note these values are effective capacitance values which take into account the DC-bias applied on the capacitors. TI does not recommend to choose the combination of *minimum* inductance and *minimum* capacitance or *maximum* inductance and *maximum* capacitance.

Ceramic capacitors have very low ESR, otherwise the maximum ESR of the capacitor must be less than $V_{OUT(ripple)} / I_{OUT(ripple)}$.

Table 7-2. Recommended Component Values

V _{OUT} (V)	R _{LOWER} (kΩ)	R _{UPPER} (kΩ)	L _{OUT} (μH)			C _{OUT} (μF)		C _{FF} (PF)
			MIN	TYP	MAX	MIN	MAX	
0.6	10	0	0.68	1	4.7	44	220	-
1	30	20	0.68	1	4.7	44	220	-
1.2	20	20	1	1.2	4.7	44	220	-
1.8	20	40	1	1.5	4.7	44	220	0-50
3.3	20	90	1.5	2.2	4.7	44	220	10-100
5.0	30	220	1.5	2.2	4.7	44	220	10-100

7.2.2.5 Input Capacitor Selection

The devices require input decoupling capacitors on power supply input V_{IN} . Also, bulk capacitors are needed depending on the application. The minimum input capacitance required is given in [Equation 7](#).

$$C_{IN(min)} = \frac{I_{OUT} \times V_{OUT}}{V_{IN(ripple)} \times V_{IN} \times F_{SW}} \quad (7)$$

TI recommends using high-quality X5R or X7R input decoupling capacitors of 30 μ F on the input voltage pin V_{IN} . The voltage rating on the input capacitor must be greater than the maximum input voltage. The capacitor must also have a ripple current rating greater than the maximum input current ripple of the application. The input ripple current is calculated by [Equation 8](#):

$$I_{CIN(rms)} = I_{OUT} \times \sqrt{\frac{V_{OUT}}{V_{IN(min)}} \times \frac{(V_{IN(min)} - V_{OUT})}{V_{IN(min)}}} \quad (8)$$

A 1- μ F ceramic capacitor is needed for the decoupling capacitor on the VCC pin.

7.2.3 Application Curves

Figure 7-2 through Figure 7-25 apply to the circuit of Figure 7-1. $V_{IN} = 12\text{ V}$, $T_A = 25^\circ\text{C}$ unless otherwise specified.

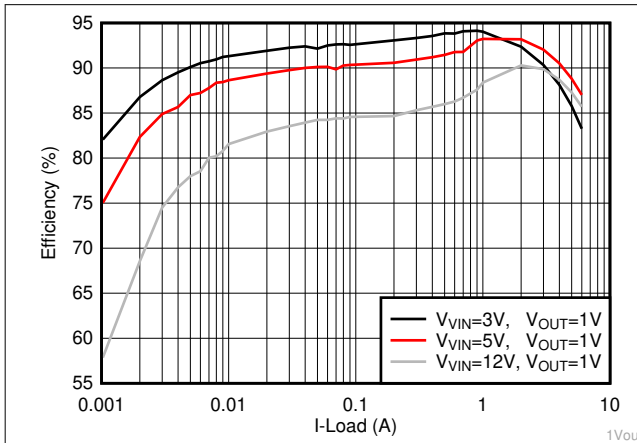

Figure 7-2. TPS566231 Efficiency Curve

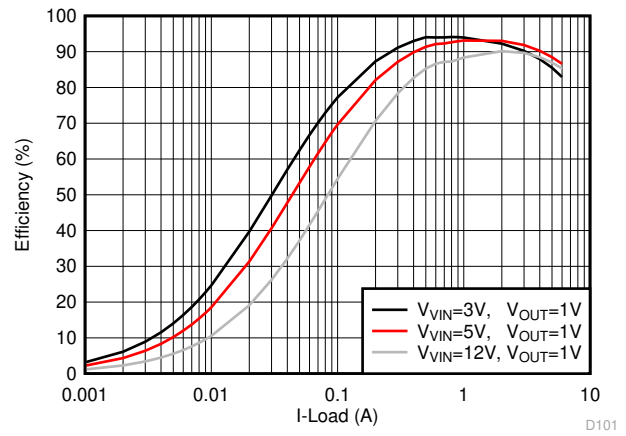

Figure 7-3. TPS566238 Efficiency Curve

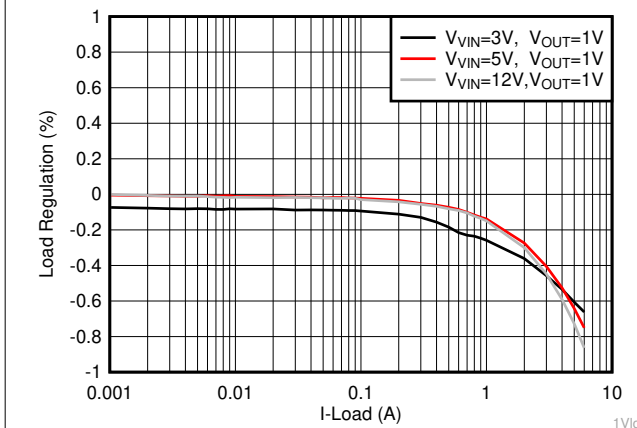

Figure 7-4. TPS566231 Load Regulation

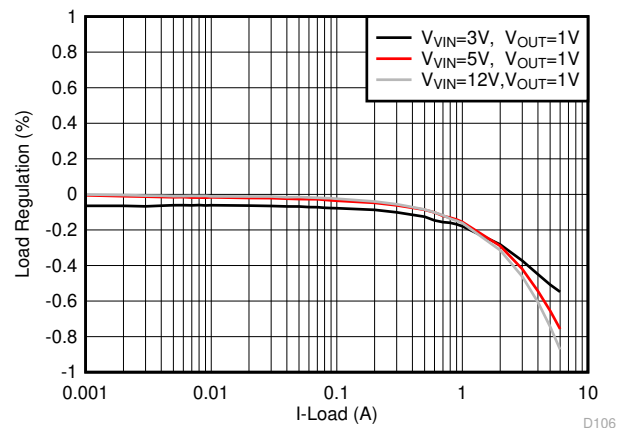

Figure 7-5. TPS566238 Load Regulation

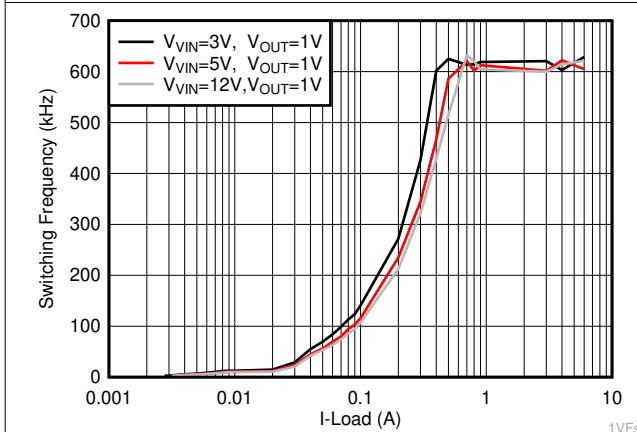

Figure 7-6. TPS566231 F_{SW} vs Output Load

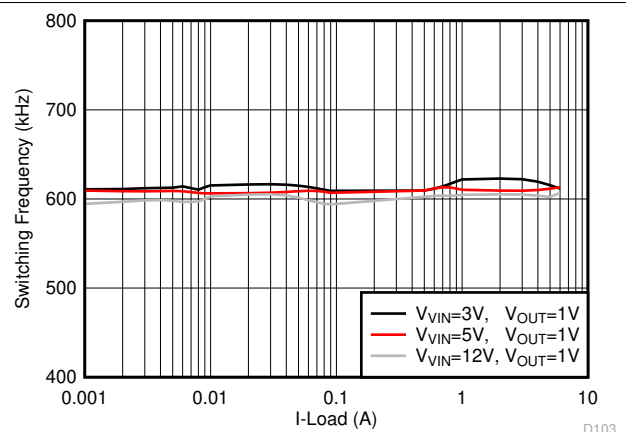

Figure 7-7. TPS566238 F_{SW} vs Output Load

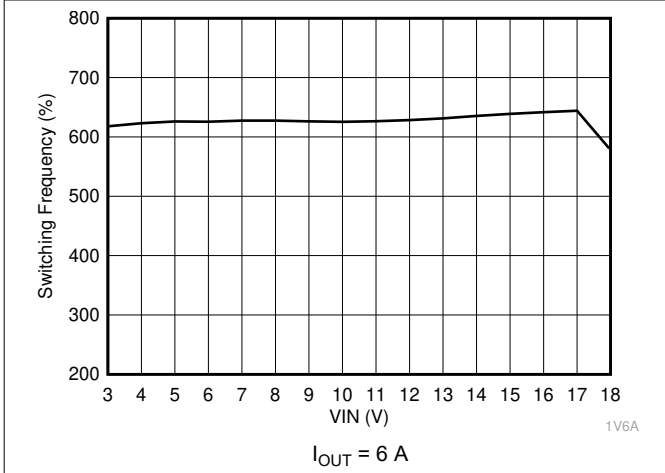

Figure 7-8. Switching Frequency vs Input Voltage

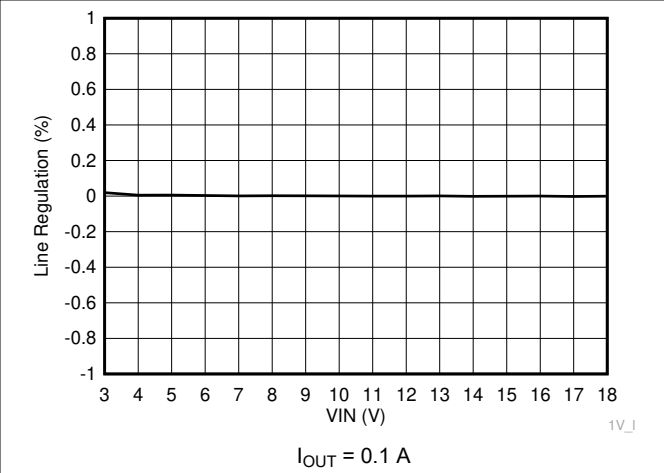

Figure 7-9. TPS566231 Line Regulation

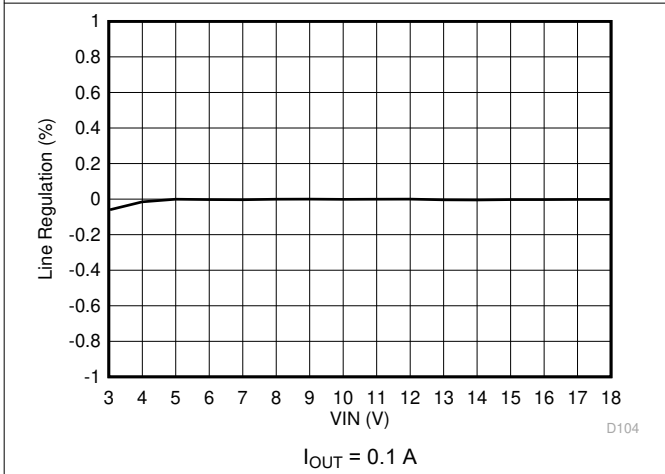

Figure 7-10. TPS566238 Line Regulation

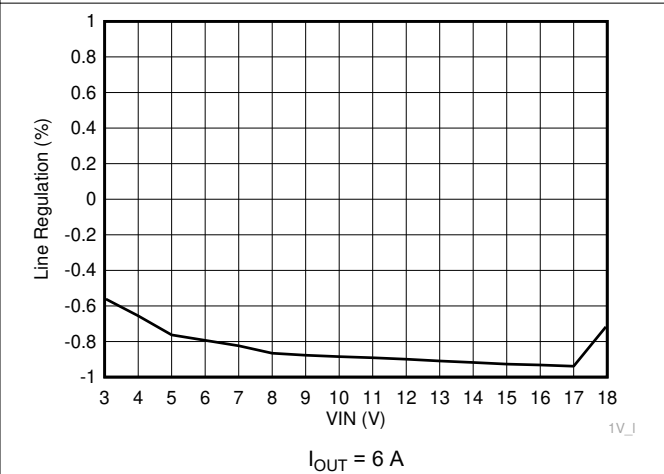

Figure 7-11. Line Regulation

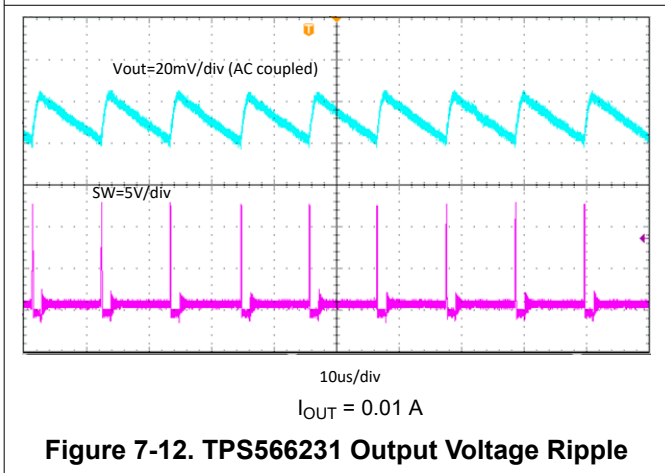

Figure 7-12. TPS566231 Output Voltage Ripple

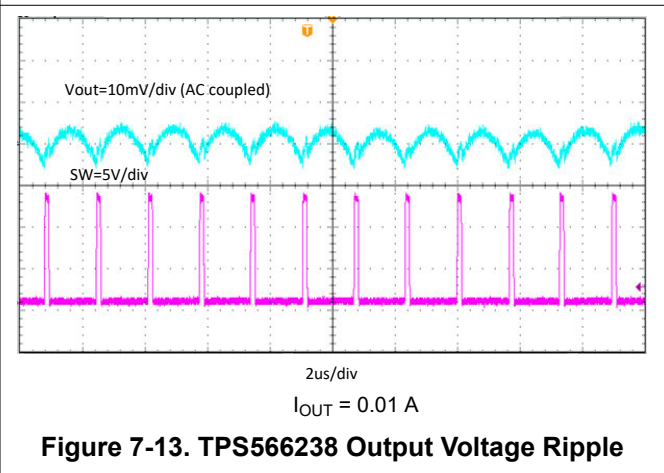

Figure 7-13. TPS566238 Output Voltage Ripple

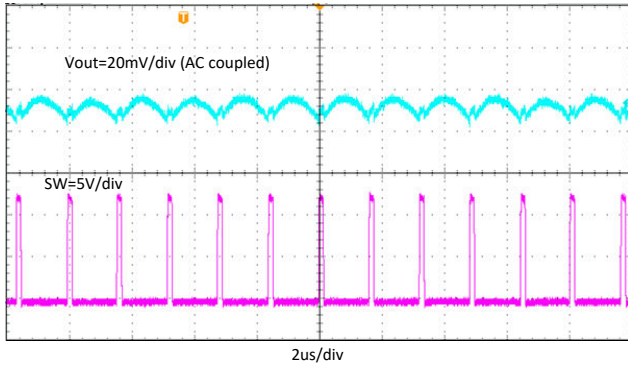

Figure 7-14. Output Voltage Ripple, $I_{OUT} = 6\text{ A}$

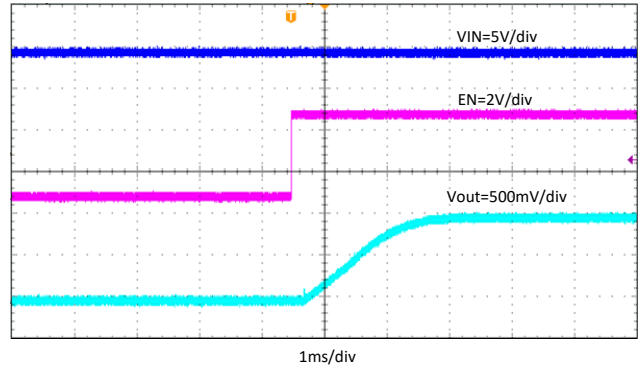

Figure 7-15. Start-Up Through EN, $I_{OUT} = 3\text{ A}$

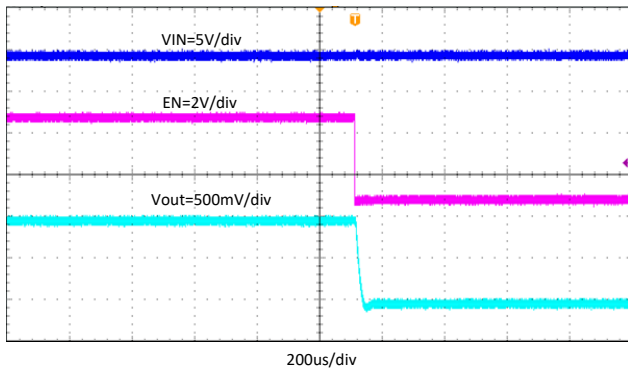

Figure 7-16. Shutdown Through EN, $I_{OUT} = 3\text{ A}$

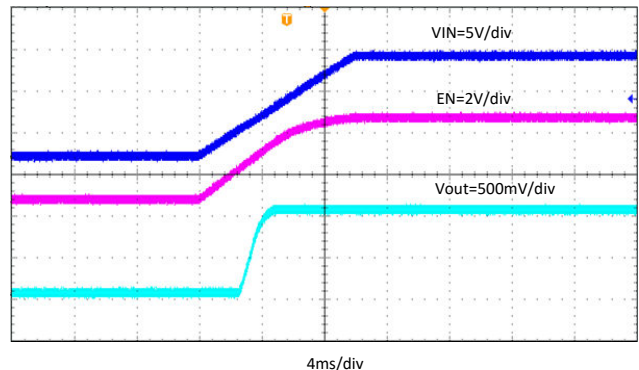

Figure 7-17. Start-Up with V_{IN} Rising, $I_{OUT} = 3\text{ A}$

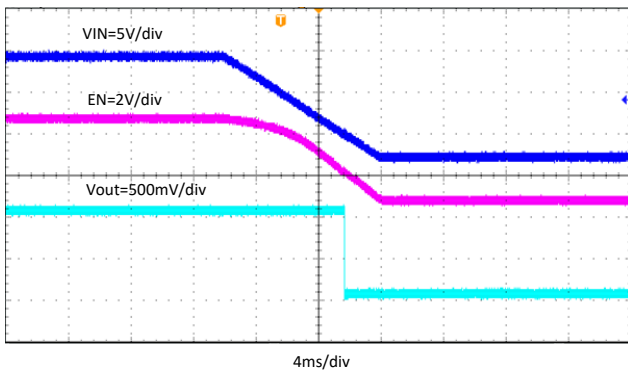

Figure 7-18. Start-Up with V_{IN} Falling, $I_{OUT} = 3\text{ A}$

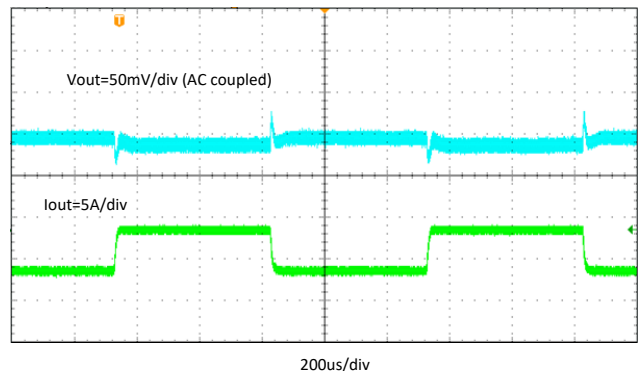
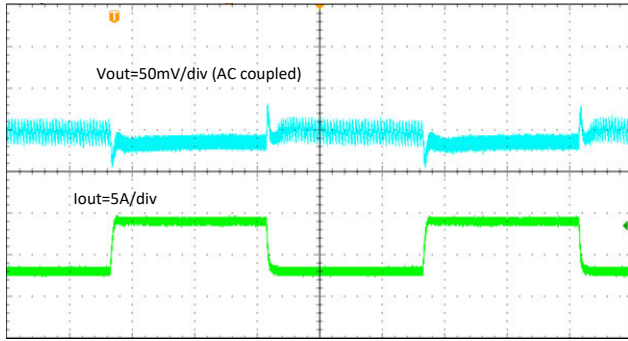
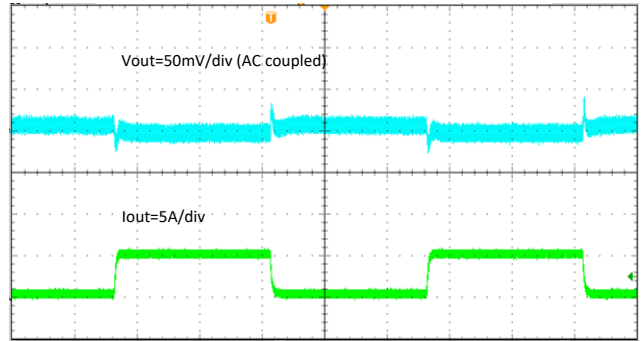

Figure 7-19. TPS566231 Transient Response
 0.6 A to 5.4 A Slew Rate = 2.5 A/ μ s



200us/div
 0.1 A to 6 A Slew Rate = 2.5 A/μs
Figure 7-20. TPS566231 Transient Response



200us/div
 0.6 A to 5.4 A Slew Rate = 2.5 A/μs
Figure 7-21. TPS566238 Transient Response

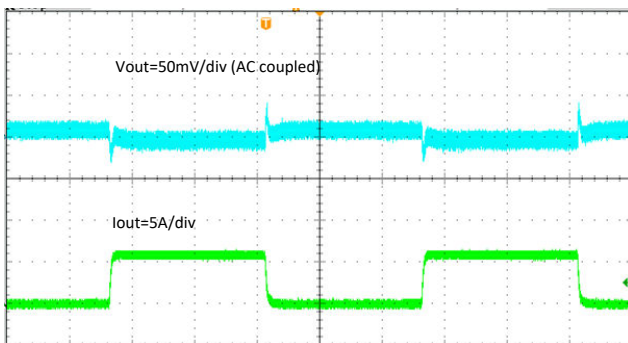

200us/div
 0.1 A to 6 A Slew Rate = 2.5 A/μs
Figure 7-22. TPS566238 Transient Response

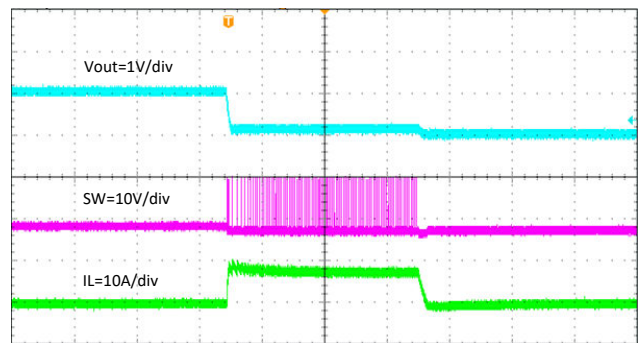

80us/div
Figure 7-23. TPS566231 Normal Operation to Output Hard Short

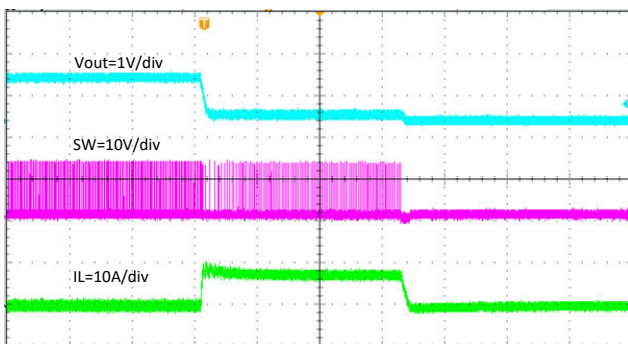

80us/div
Figure 7-24. TPS566238 Normal Operation to Output Hard Short

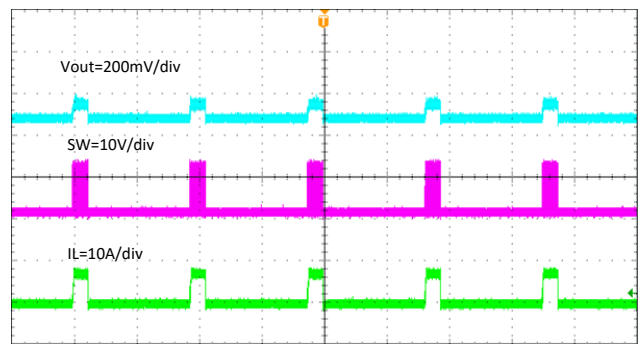

10ms/div
Figure 7-25. Output Hard Short Hiccup

7.3 Power Supply Recommendations

The TPS56623x is intended to be powered by a well-regulated dc voltage. The input voltage range is 3 V to 18 V. The input supply voltage must be greater than the desired output voltage for proper operation. Input supply current must be appropriate for the desired output current. TI recommends additional bulk capacitance if the input voltage supply is located far from the TPS56623x circuit. Typical values are 100 μF to 470 μF.

7.4 Layout

7.4.1 Layout Guidelines

- Use a four-layer PCB for good thermal performance and with maximum ground plane. 55-mm × 60-mm, four-layer PCB with 2-1-1-2 oz copper is used as example.
- Place the decoupling capacitors right across VIN and VCC as close as possible.
- Place an output inductor and capacitors with IC at the same layer. SW routing must be as short as possible to minimize EMI, and must be a width plane to carry big current. Enough vias must be added to the PGND connection of the output capacitor and as close to the output pin as possible.
- Place a BST resistor and capacitor with IC at the same layer, close to BST and SW plane. TI recommends a 15-mil width trace to reduce line parasitic inductance.
- Feedback must be routed away from the switching node, BST node, or other high frequency signal.
- The VIN trace must be wide to reduce the trace impedance and provide enough current capability.
- Place multiple vias under the device near VIN and PGND and near input capacitors to reduce parasitic inductance and improve thermal performance.

7.4.2 Layout Example

Figure 7-26 shows the recommended top-side layout. Component reference designators are the same as the circuit shown in Figure 7-1. A resistor divider for EN is not used in the circuit of Figure 7-1, but are shown in the layout for reference.

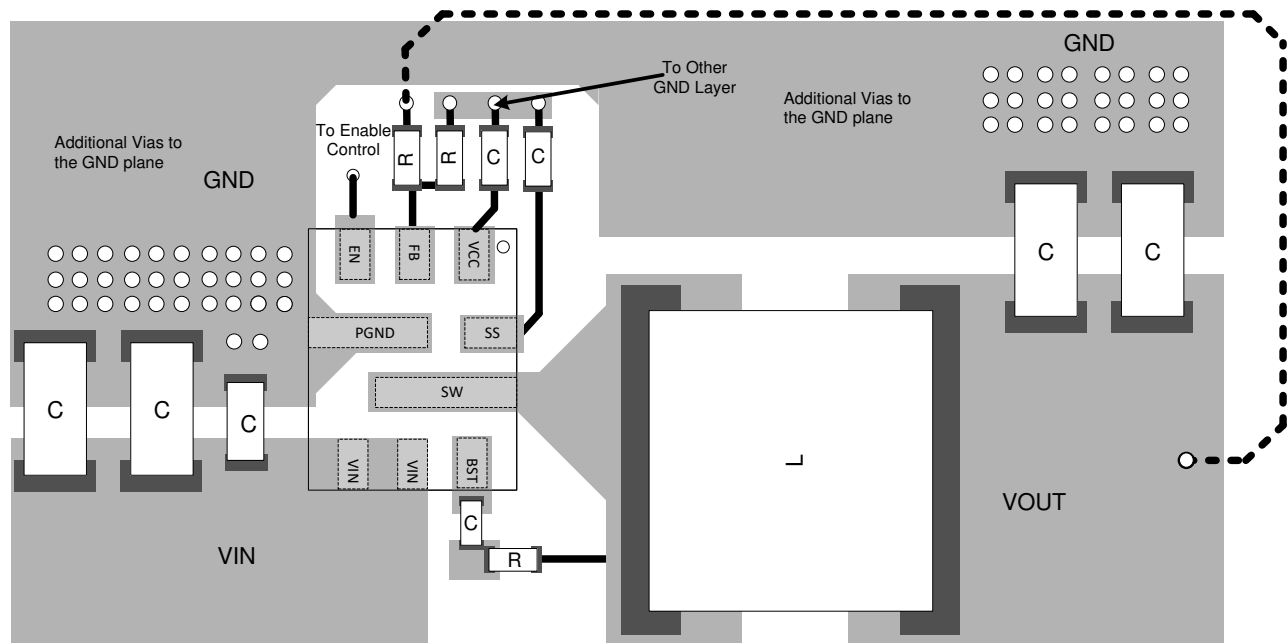

Figure 7-26. Top-Layer Layout

8 Device and Documentation Support

8.1 Device Support

8.1.1 Development Support

8.1.1.1 Custom Design with WEBENCH® Tools

[Click here](#) to create a custom design using the TPS56623x device with the WEBENCH Power Designer.

1. Start by entering the input voltage (V_{IN}), output voltage (V_{OUT}), and output current (I_{OUT}) requirements.
2. Optimize the design for key parameters such as efficiency, footprint, and cost.
3. Compare the generated design with other possible solutions from Texas Instruments.

The WEBENCH Power Designer provides a customized schematic along with a list of materials with real-time pricing and component availability.

In most cases, these actions are available:

- Estimate IC thermal and efficiency performance
- Run electrical simulations to see important waveforms and circuit performance
- Export customized schematic and layout into popular CAD formats
- Print PDF reports for the design, and share the design with colleagues

Get more information about WEBENCH tools at www.ti.com/WEBENCH.

8.2 Receiving Notification of Documentation Updates

To receive notification of documentation updates, navigate to the device product folder on ti.com. Click on *Notifications* to register and receive a weekly digest of any product information that has changed. For change details, review the revision history included in any revised document.

8.3 Support Resources

[TI E2E™ support forums](#) are an engineer's go-to source for fast, verified answers and design help — straight from the experts. Search existing answers or ask your own question to get the quick design help you need.

Linked content is provided "AS IS" by the respective contributors. They do not constitute TI specifications and do not necessarily reflect TI's views; see TI's [Terms of Use](#).

8.4 Trademarks

D-CAP3™, HotRod™, ULQ™, and TI E2E™ are trademarks of Texas Instruments.

WEBENCH® is a registered trademark of Texas Instruments.

All trademarks are the property of their respective owners.

8.5 Electrostatic Discharge Caution



This integrated circuit can be damaged by ESD. Texas Instruments recommends that all integrated circuits be handled with appropriate precautions. Failure to observe proper handling and installation procedures can cause damage.

ESD damage can range from subtle performance degradation to complete device failure. Precision integrated circuits may be more susceptible to damage because very small parametric changes could cause the device not to meet its published specifications.

8.6 Glossary

[TI Glossary](#) This glossary lists and explains terms, acronyms, and definitions.

9 Revision History

NOTE: Page numbers for previous revisions may differ from page numbers in the current version.

Changes from Revision A (January 2021) to Revision B (December 2023)	Page
• Added a bullet for available Mandarin data sheet in the <i>Features</i> section; Updated trademark information; Deleted random color from the first page image.....	1
• Updated the <i>ESD Ratings</i> table to show CDM testing was per JS-002.....	4
• Added <i>Custom Design with WEBENCH® Tools</i> section.....	15
• Added text in <i>Output Capacitor Selection</i> to state that the Table 7-2 values are effective values based on DC-bias.....	16
• Added <i>Custom Design with WEBENCH® Tools</i> section.....	23
<hr/>	
Changes from Revision * (May 2020) to Revision A (January 2021)	Page
• Changed device status from Advance Information to Production Data.....	1
• Updated the numbering format for tables, figures and cross-references throughout the document.....	1

10 Mechanical, Packaging, and Orderable Information

The following pages include mechanical, packaging, and orderable information. This information is the most current data available for the designated devices. This data is subject to change without notice and revision of this document. For browser-based versions of this data sheet, refer to the left-hand navigation.

PACKAGING INFORMATION

Orderable Device	Status (1)	Package Type	Package Drawing	Pins	Package Qty	Eco Plan (2)	Lead finish/ Ball material (6)	MSL Peak Temp (3)	Op Temp (°C)	Device Marking (4/5)	Samples
TPS566231PRQFR	ACTIVE	VQFN-HR	RQF	9	3000	RoHS & Green	NIPDAU SN	Level-2-260C-1 YEAR	-40 to 125	1ID	Samples
TPS566231RQFR	ACTIVE	VQFN-HR	RQF	9	3000	RoHS & Green	NIPDAU SN	Level-2-260C-1 YEAR	-40 to 125	1H4	Samples
TPS566238PRQFR	ACTIVE	VQFN-HR	RQF	9	3000	RoHS & Green	NIPDAU SN	Level-2-260C-1 YEAR	-40 to 125	1IE	Samples
TPS566238RQFR	ACTIVE	VQFN-HR	RQF	9	3000	RoHS & Green	NIPDAU SN	Level-2-260C-1 YEAR	-40 to 125	1H5	Samples

(1) The marketing status values are defined as follows:

ACTIVE: Product device recommended for new designs.

LIFEBUY: TI has announced that the device will be discontinued, and a lifetime-buy period is in effect.

NRND: Not recommended for new designs. Device is in production to support existing customers, but TI does not recommend using this part in a new design.

PREVIEW: Device has been announced but is not in production. Samples may or may not be available.

OBSELETE: TI has discontinued the production of the device.

(2) **RoHS:** TI defines "RoHS" to mean semiconductor products that are compliant with the current EU RoHS requirements for all 10 RoHS substances, including the requirement that RoHS substance do not exceed 0.1% by weight in homogeneous materials. Where designed to be soldered at high temperatures, "RoHS" products are suitable for use in specified lead-free processes. TI may reference these types of products as "Pb-Free".

RoHS Exempt: TI defines "RoHS Exempt" to mean products that contain lead but are compliant with EU RoHS pursuant to a specific EU RoHS exemption.

Green: TI defines "Green" to mean the content of Chlorine (Cl) and Bromine (Br) based flame retardants meet JS709B low halogen requirements of <=1000ppm threshold. Antimony trioxide based flame retardants must also meet the <=1000ppm threshold requirement.

(3) MSL, Peak Temp. - The Moisture Sensitivity Level rating according to the JEDEC industry standard classifications, and peak solder temperature.

(4) There may be additional marking, which relates to the logo, the lot trace code information, or the environmental category on the device.

(5) Multiple Device Markings will be inside parentheses. Only one Device Marking contained in parentheses and separated by a "-" will appear on a device. If a line is indented then it is a continuation of the previous line and the two combined represent the entire Device Marking for that device.

(6) Lead finish/Ball material - Orderable Devices may have multiple material finish options. Finish options are separated by a vertical ruled line. Lead finish/Ball material values may wrap to two lines if the finish value exceeds the maximum column width.

Important Information and Disclaimer:The information provided on this page represents TI's knowledge and belief as of the date that it is provided. TI bases its knowledge and belief on information provided by third parties, and makes no representation or warranty as to the accuracy of such information. Efforts are underway to better integrate information from third parties. TI has taken and

continues to take reasonable steps to provide representative and accurate information but may not have conducted destructive testing or chemical analysis on incoming materials and chemicals. TI and TI suppliers consider certain information to be proprietary, and thus CAS numbers and other limited information may not be available for release.

In no event shall TI's liability arising out of such information exceed the total purchase price of the TI part(s) at issue in this document sold by TI to Customer on an annual basis.

TAPE AND REEL INFORMATION

QUADRANT ASSIGNMENTS FOR PIN 1 ORIENTATION IN TAPE



*All dimensions are nominal

Device	Package Type	Package Drawing	Pins	SPQ	Reel Diameter (mm)	Reel Width W1 (mm)	A0 (mm)	B0 (mm)	K0 (mm)	P1 (mm)	W (mm)	Pin1 Quadrant
TPS566231PRQFR	VQFN-HR	RQF	9	3000	180.0	8.4	1.75	2.25	1.0	4.0	8.0	Q2
TPS566231PRQFR	VQFN-HR	RQF	9	3000	180.0	8.4	1.8	2.25	1.15	4.0	8.0	Q2
TPS566231RQFR	VQFN-HR	RQF	9	3000	180.0	8.4	1.8	2.25	1.15	4.0	8.0	Q2
TPS566231RQFR	VQFN-HR	RQF	9	3000	180.0	8.4	1.75	2.25	1.0	4.0	8.0	Q2
TPS566238PRQFR	VQFN-HR	RQF	9	3000	180.0	8.4	1.8	2.25	1.15	4.0	8.0	Q2
TPS566238PRQFR	VQFN-HR	RQF	9	3000	180.0	8.4	1.75	2.25	1.0	4.0	8.0	Q2
TPS566238RQFR	VQFN-HR	RQF	9	3000	180.0	8.4	1.75	2.25	1.0	4.0	8.0	Q2
TPS566238RQFR	VQFN-HR	RQF	9	3000	180.0	8.4	1.8	2.25	1.15	4.0	8.0	Q2

TAPE AND REEL BOX DIMENSIONS

*All dimensions are nominal

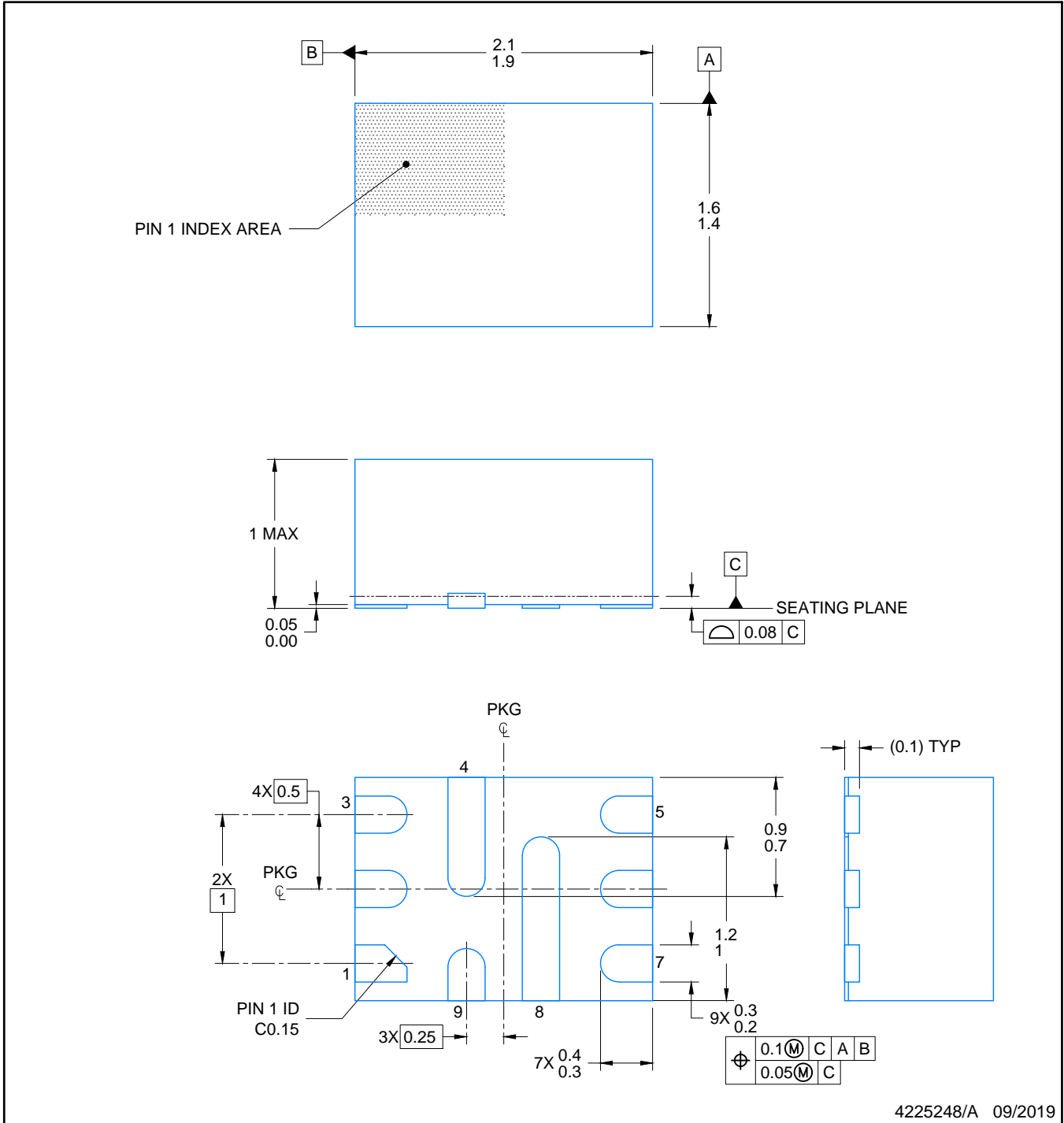
Device	Package Type	Package Drawing	Pins	SPQ	Length (mm)	Width (mm)	Height (mm)
TPS566231PRQFR	VQFN-HR	RQF	9	3000	210.0	185.0	35.0
TPS566231PRQFR	VQFN-HR	RQF	9	3000	210.0	185.0	35.0
TPS566231RQFR	VQFN-HR	RQF	9	3000	210.0	185.0	35.0
TPS566231RQFR	VQFN-HR	RQF	9	3000	210.0	185.0	35.0
TPS566238PRQFR	VQFN-HR	RQF	9	3000	210.0	185.0	35.0
TPS566238PRQFR	VQFN-HR	RQF	9	3000	210.0	185.0	35.0
TPS566238RQFR	VQFN-HR	RQF	9	3000	210.0	185.0	35.0
TPS566238RQFR	VQFN-HR	RQF	9	3000	210.0	185.0	35.0



4225248/A 09/2019

NOTES:

1. All linear dimensions are in millimeters. Any dimensions in parenthesis are for reference only. Dimensioning and tolerancing per ASME Y14.5M.
2. This drawing is subject to change without notice.

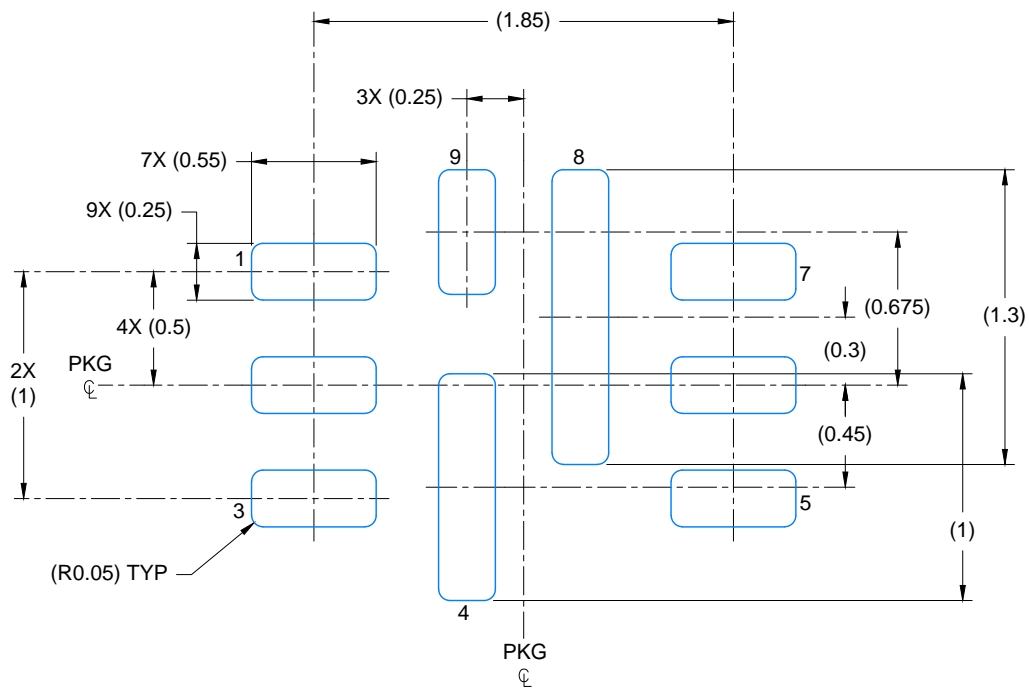

LAND PATTERN EXAMPLE
EXPOSED METAL SHOWN
SCALE: 30X

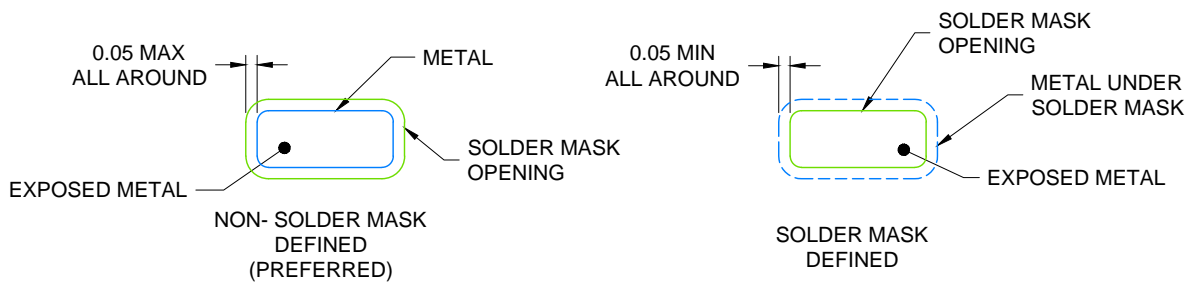

SOLDER MASK DETAILS
NOT TO SCALE

4225248/A 09/2019

NOTES: (continued)

3. For more information, see Texas Instruments literature number SLUA271 (www.ti.com/lit/slua271).
4. Solder mask tolerances between and around signal pads can vary based on board fabrication site.

EXAMPLE STENCIL DESIGN

RQF0009A

VQFN-HR - 1 mm max height

PLASTIC QUAD FLATPACK- NO LEAD

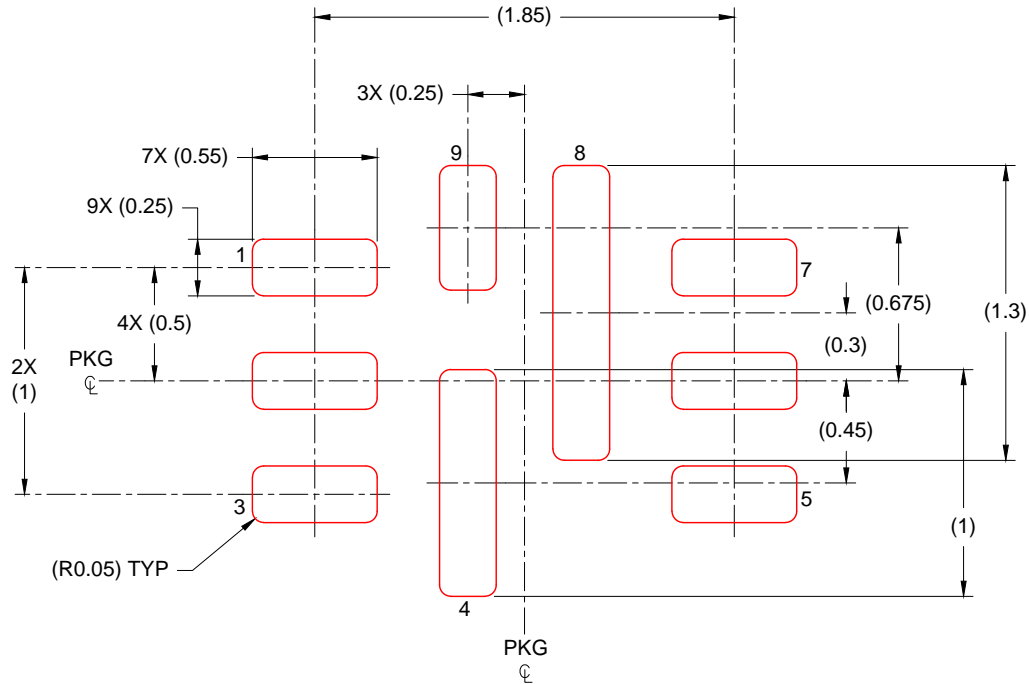

SOLDER PASTE EXAMPLE
BASED ON 0.100 mm THICK STENCIL
SCALE: 30X

4225248/A 09/2019

NOTES: (continued)

5. Laser cutting apertures with trapezoidal walls and rounded corners may offer better paste release. IPC-7525 may have alternate design recommendations.

IMPORTANT NOTICE AND DISCLAIMER

TI PROVIDES TECHNICAL AND RELIABILITY DATA (INCLUDING DATA SHEETS), DESIGN RESOURCES (INCLUDING REFERENCE DESIGNS), APPLICATION OR OTHER DESIGN ADVICE, WEB TOOLS, SAFETY INFORMATION, AND OTHER RESOURCES "AS IS" AND WITH ALL FAULTS, AND DISCLAIMS ALL WARRANTIES, EXPRESS AND IMPLIED, INCLUDING WITHOUT LIMITATION ANY IMPLIED WARRANTIES OF MERCHANTABILITY, FITNESS FOR A PARTICULAR PURPOSE OR NON-INFRINGEMENT OF THIRD PARTY INTELLECTUAL PROPERTY RIGHTS.

These resources are intended for skilled developers designing with TI products. You are solely responsible for (1) selecting the appropriate TI products for your application, (2) designing, validating and testing your application, and (3) ensuring your application meets applicable standards, and any other safety, security, regulatory or other requirements.

These resources are subject to change without notice. TI grants you permission to use these resources only for development of an application that uses the TI products described in the resource. Other reproduction and display of these resources is prohibited. No license is granted to any other TI intellectual property right or to any third party intellectual property right. TI disclaims responsibility for, and you will fully indemnify TI and its representatives against, any claims, damages, costs, losses, and liabilities arising out of your use of these resources.

TI's products are provided subject to [TI's Terms of Sale](#) or other applicable terms available either on [ti.com](https://www.ti.com) or provided in conjunction with such TI products. TI's provision of these resources does not expand or otherwise alter TI's applicable warranties or warranty disclaimers for TI products.

TI objects to and rejects any additional or different terms you may have proposed.

Mailing Address: Texas Instruments, Post Office Box 655303, Dallas, Texas 75265
Copyright © 2023, Texas Instruments Incorporated