

# S100



## THE UNIVERSAL MINIATURE PHOTOELECTRIC SENSOR

- Two threaded front mounting holes
- Two slotted rear mounting holes
- Anti-tampering sensor (no adjustment)
- High speed high resolution RGB contrast sensor available
- Transparent object detection
- M8 connector and cable models
- PNP or NPN models with Light/Dark selection by wire
- Plastic housing, IP67 mechanical protection
- IO-Link COM2 communication protocol
- IO-Link V1.1.2 version
- IO-Link extended parametrization for monitoring and maintenance

### APPLICATIONS

- Processing and packaging machines
- Conveyors
- Automatic warehousing
- Intralogistic lines
- Bottling
- Cosmetic and Pharma machinery
- Industry 4.0 application compliant

### S100

<b>Through beam</b>		12 m
<b>Retroreflective</b>		7 m
<b>Polarized Retroreflective (long range)</b>		5,5 m
<b>Polarized Retroreflective (short range)</b>		3 m
<b>Transparent Retroreflective (short range)</b>		500 mm
<b>Transparent Retroreflective (long range)</b>		2 m
<b>Diffused proximity (short range)</b>		300 mm
<b>Diffused proximity (long range)</b>		500 mm
<b>Fixed focus</b>		70 mm
<b>Background Suppression (short range)</b>		100 mm
<b>Background Suppression (long range)</b>		200 mm
<b>RGB Mark Reader</b>		12,5mm+/-2mm
<b>Power supply</b>	Vdc	10...30 Vdc
<b>Output</b>	PNP	•
	NPN	•
<b>Connectivity</b>	IO-Link	IO-Link V1.1.2 Smart Sensor Profile Fully programmable double output stage through IO-Link parametrization
<b>Connection</b>	cable	2 m cable, 4 wires
	connector	M8 conn., 4-pole
<b>Approximate dimensions (mm)</b>		32x20x12
<b>Housing material</b>		Plastic
<b>Mechanical protection</b>		IP67

# TECHNICAL DATA

<b>Power supply</b>	10 ... 30 Vdc
<b>Ripple</b>	10% max.
<b>Consumption (output current excluded)</b>	35 mA max. (mod. S100...W) 30 mA max. (mod. S100...B/M/ T IO-Link) red LED 632 nm (mod. S100...B/C/D/M01) IR LED 860 nm (mod. S100...A/G/Txx/M10) RGB LED (mod. S100-W00)
<b>Light emission</b>	
<b>Spot size</b>	1.5mm x 6.5mm (mod. S100-W00)
<b>Setting</b>	remote teach-in (mod. S100...Mxx/Txx/W00)
<b>Operating mode</b>	LIGHT/DARK selectable by wire (mod. S100...A/B/C/D/F) yellow OUTPUT LED (excl. mod. G) green POWER LED (mod. S100...G)
<b>Indicators</b>	PNP or NPN
<b>Output</b>	Fully programmable output stage only in IO-Link model Pin 2 I/O programmable only for IO-Link models
<b>Output current</b>	100 mA
<b>IO-Link Connectivity</b>	V1.1.2
<b>IO-Link COM</b>	COM2
<b>IO-Link min cycle</b>	2.3ms
<b>Saturation voltage</b>	2 V max.
<b>Response time</b>	2 ms (mod. S100...FG) 1 ms (mod. S100...A/Bxx/C/D/Mxx/Txx/T IO-Link), 500µs (B IO-Link), 25µs (W00-xx)
<b>Switching frequency</b>	250 Hz (mod. S100...FG) 500 Hz (mod. S100...A/Bxx/C/D/Mxx/Txx/T IO-Link), 1KHz (B IO-Link), 20kHz (W00-xx)
<b>Jitter</b>	13µs(W00-xx)
<b>Connection</b>	2 m cable Ø 3,5 mm, M8 4-pole connector
<b>Dielectric strength</b>	500 Vac, 1 min between electronics and housing
<b>Insulating resistance</b>	>20 MΩ, 500 Vdc between electronics and housing
<b>Mechanical protection</b>	IP67
<b>Ambient light rejection</b>	according to EN 60947-5-2
<b>Vibrations</b>	0,5 mm amplitude, 10 ... 55 Hz frequency, for every axis (EN60068-2-6)
<b>Shock resistance</b>	11 ms (30 G) 6 shock for every axis (EN60068-2-27)
<b>Housing material</b>	ABS body, PMMA indicators cover
<b>Lens material</b>	PC lens, PMMA window
<b>Operating temperature</b>	-25... 55 °C
<b>Storage temperature</b>	-40 ... 70 °C
<b>Weight</b>	50 g max. cable vers., 10 g max. connector vers.

# DIMENSIONS

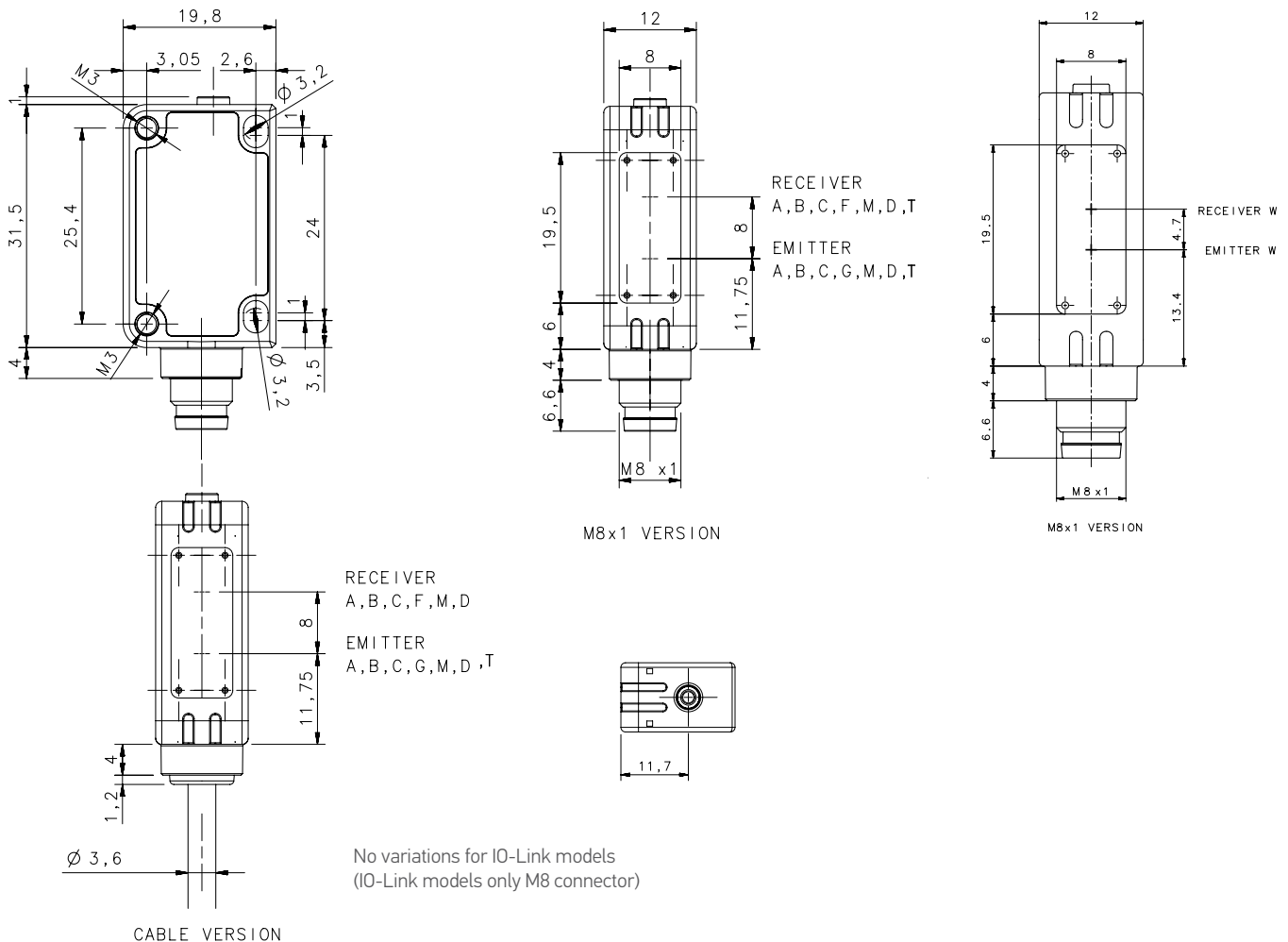

# CONNECTIONS

## M8 CONNECTOR

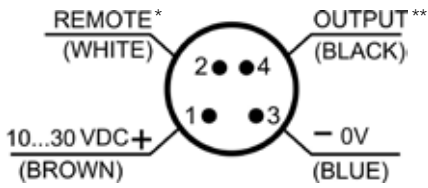

## CABLE

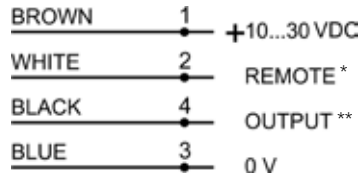

## S100-PR-5-(B10, M10, T10, W00)-OZ

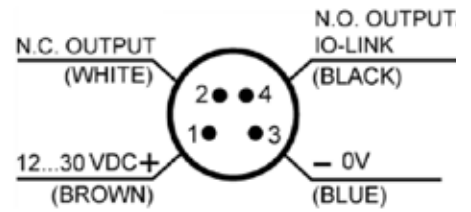

\*REMOTE: Light/Dark selection (S100-...-A-B-C-D-F), External Teach-in (S100-...-Mxx/Txx/W00)  
 \*\*OUTPUT: PNP or NPN depends on the model

Pin 2 I/O programmable only for IO-Link models

# INDICATORS AND SETTINGS

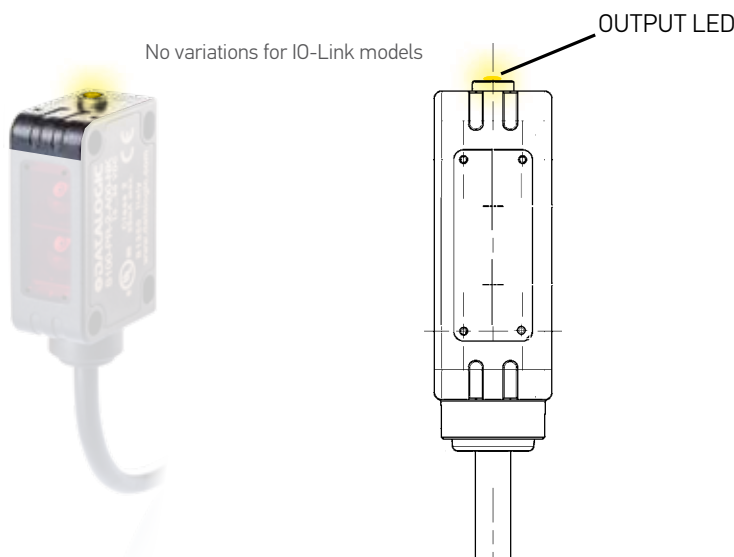

# DETECTION DIAGRAMS

## THROUGH BEAM

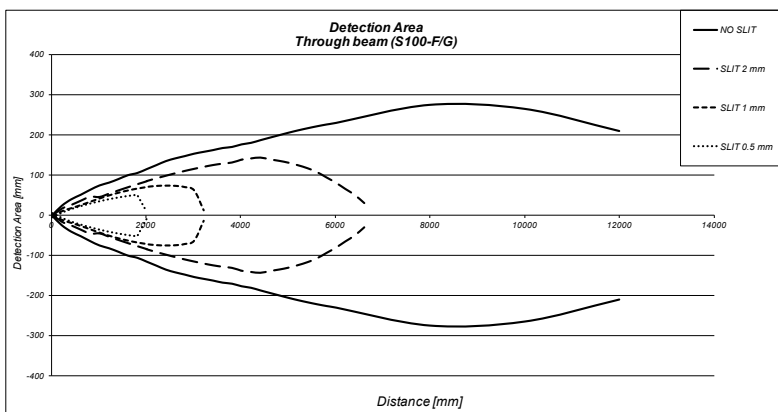

	max. operating distance
NO SLIT	12 m
2 mm SLIT	6,7 m
1 mm SLIT	3,2 m
0,5 mm SLIT	2 m

### DIFFUSE PROXIMITY

	SHORT RANGE (S100-...-C0)	LONG RANGE (S100-...-C1)
Recommended operating distance (on White 90% target)	10...240 mm	2...400 mm
Maximum operating distance (White 90% target)	1...300 mm	0...500 mm
Maximum operating distance (Grey 18% target)	20...150 mm	10...280 mm
Maximum operating distance (Black 6% target)	30...80 mm	20...160 mm
Difference White-Grey	50%	50%
Difference White-Black	75%	75%
Hysteresis	20%	20%

#### DIFFUSE (SHORT RANGE: S100-C00)

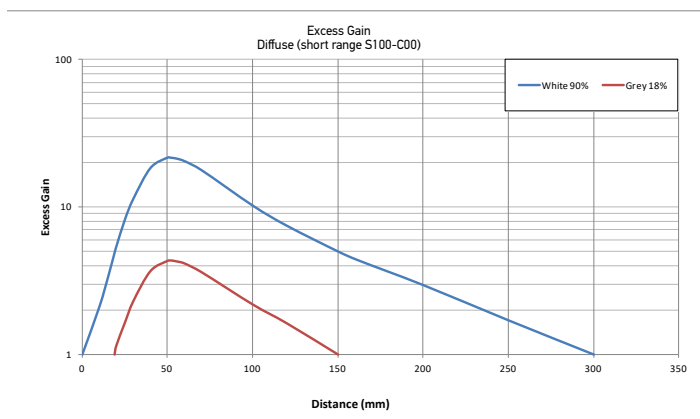
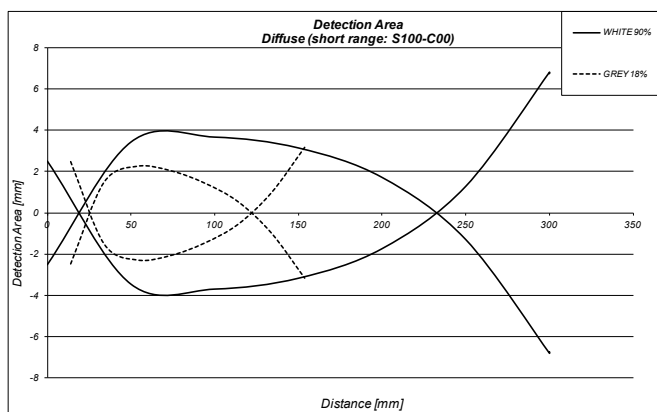

#### DIFFUSE (LONG RANGE: S100-C10)

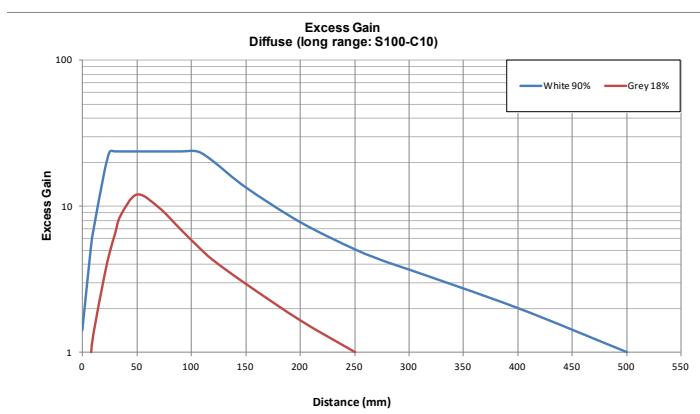
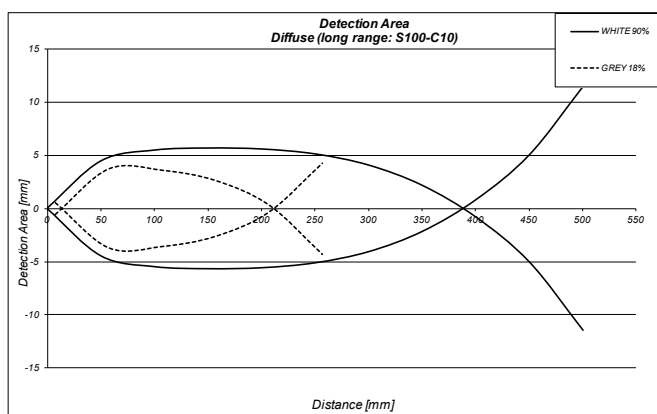

## POLARIZED RETROREFLECTIVE

REFLECTOR	TYPE	SHORT RANGE (S100-...-B00)	LONG RANGE (S100-...-B10) IO-Link
R1	circular (23 mm)	0,2..0,8 m	0,02..2 m
R2	circular (48 mm)	0,03..2 m	0,01..4,5 m
R3	rectangular (18x54 mm)	0,03..1,5 m	0,01..3 m
R4	rectangular (47x47 mm)	0,03..2,5 m	0,01..4,5 m
R5	circular (75 mm)	0,01..3 m	0,01..5,5 m
R6	rectangular (36x55 mm)	0,03..1,8 m	0,01..4 m
RT3970	self-adhesive tape (60x40 mm)	0,2..0,8 m	0,05..1,8 m



	max. operating distance			
	SHORT RANGE (S100-...-B00)		LONG RANGE (S100-...-B10) IO-Link	
	with R5 reflector	with R2 reflector	with R5 reflector	with R2 reflector
<b>NO SLIT</b>	0,02 ... 3 m	0,02 ... 2 m	0,1...5,5 m	0,01...4,5 m
<b>2 mm SLIT</b>	0,05 ... 1,5 m	0,05 ... 0,8 m	0,2...4 m	0,03...3 m
<b>1 mm SLIT</b>	-	-	0,3...2,5 m	0,05...1,5 m
<b>0,5 mm SLIT</b>	-	-	0,5...1,2 m	0,07...0,7 m

### POLARIZED RETROREFLECTIVE (SHORT RANGE: S100-B00)

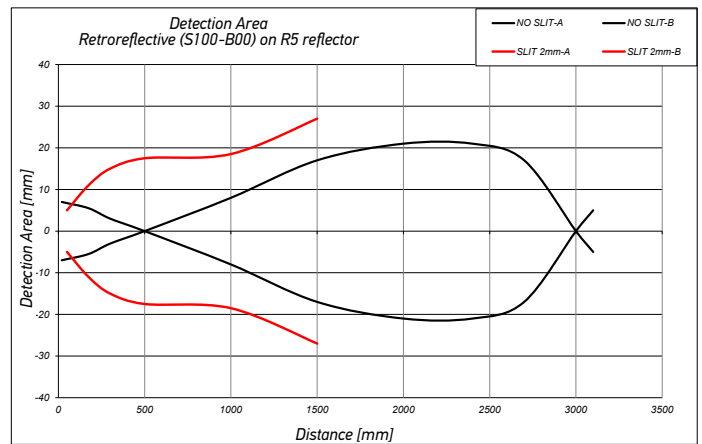
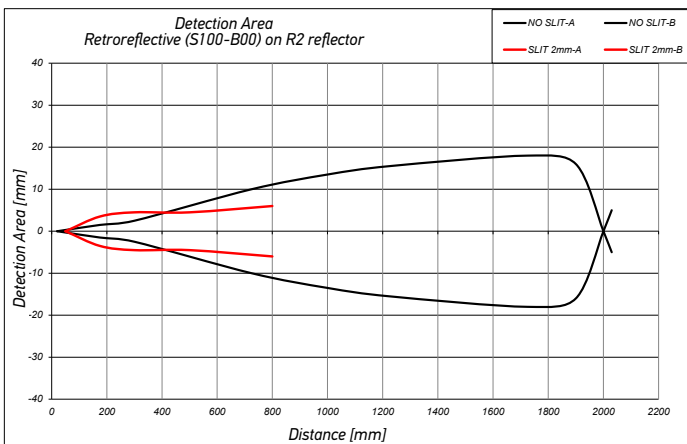

### IO-Link POLARIZED RETROREFLECTIVE (LONG RANGE: S100-PR-5-B10-PK, ...-OZ)

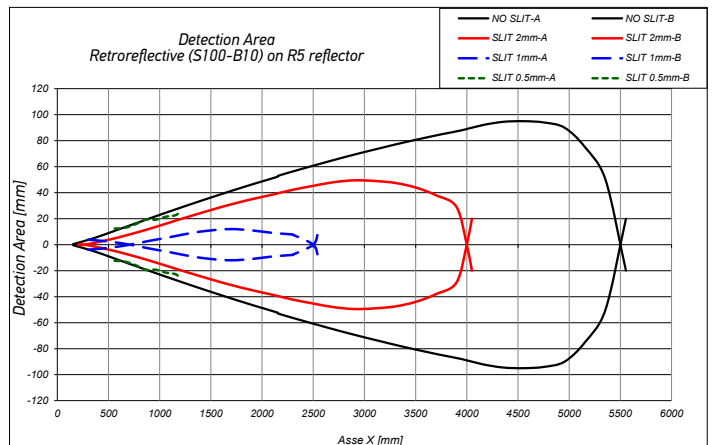
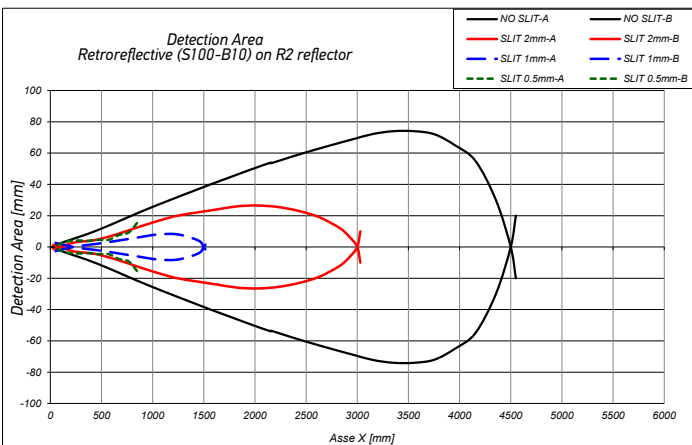

## RETROREFLECTIVE (INFRARED)

REFLECTOR	TYPE	(S100-...-A00)
R1	circular (23 mm)	0.03..3 m
R2	circular (48 mm)	0.01..6 m
R3	rectangular (18x54 mm)	0.01..3.5 m
R4	rectangular (47x47 mm)	0.01..5 m
R5	circular (75 mm)	0.01..7 m
R6	rectangular (36x55 mm)	0.01..6 m
RT3970	self-adhesive tape (60x40 mm)	0,05..2 m



	max. operating distance	
	with R5 reflector	with R2 reflector
NO SLIT	7 m	6 m
2 mm SLIT	4,7 m	3,4 m
1 mm SLIT	2,7 m	2,3 m
0,5 mm SLIT	1,5 m	1 m

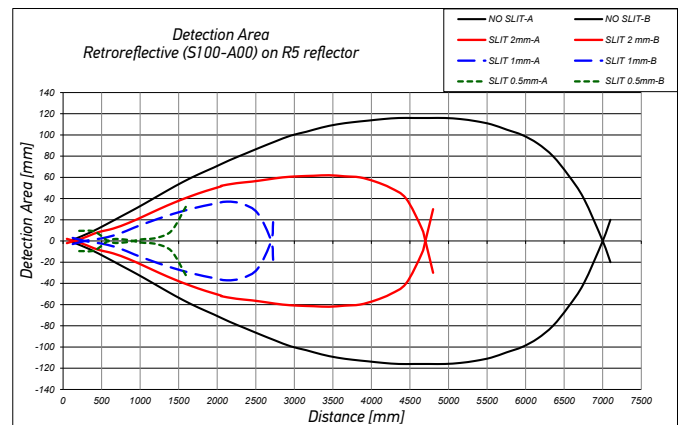
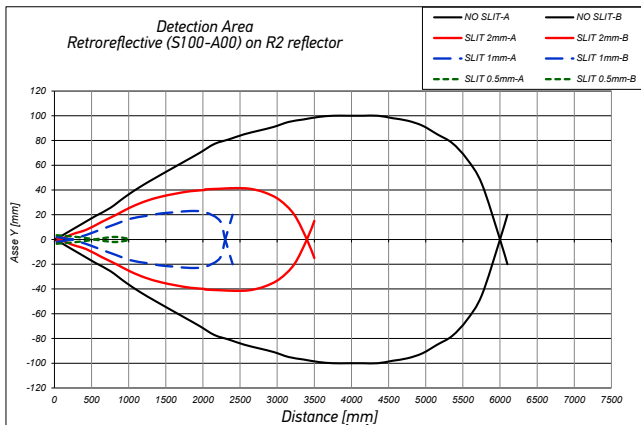

## FIXED FOCUS

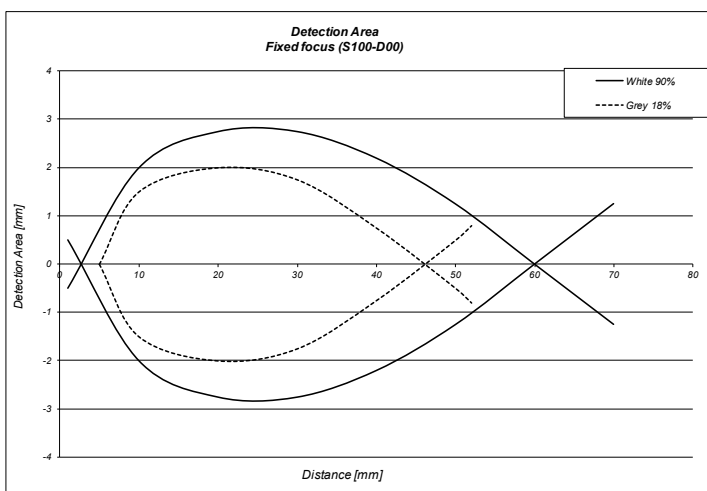

Focus point	70 mm
Maximum operating distance (White 90%)	70 mm
Maximum operating distance (Grey 18%)	55 mm
Difference White/Black	25%

## RETROREFLECTIVE FOR TRANSPARENT (INFRARED)

REFLECTOR	TYPE	SHORT RANGE (S100-...-T00)	LONG RANGE (S100-...-T10)	LONG RANGE (S100-...-T10)
R1	circular (23 mm)	0.1...0.3 m	0.4...1 m	0.1...1 m
R2	circular (48 mm)	0.1...0.5 m	0.8...2 m	0.1...2 m
R3	rectangular (18x54 mm)	0.1...0.3 m	0.4...1 m	0.1...1 m
R4	rectangular (47x47 mm)	0.1...0.5 m	0.8...2 m	0.1...2 m
R5	circular (75 mm)	0.1...0.8 m	0.8...2.5 m	0.1...2.5 m
R6	rectangular (36x55 mm)	0.1...0.5 m	0.8...2m	0.1...2m
RT3970	self-adhesive tape (60x40 mm)	0.15...0.3 m	0.1...0.8 m	0.1...0.8 m



	max. operating distance				
	SHORT RANGE (S100-...-T00)		LONG RANGE (S100-...-T10)		LONG RANGE (S100-...-T10)
	with R5 reflector	with R2 reflector	with R5 reflector	with R2 reflector	with R2 reflector
<b>NO SLIT</b>	0.1...0.8 m	0.1...0.5 m	0.8...2.5 m	0.8...2 m	0.1...2 m
<b>2 mm SLIT</b>	0.1...0.5 m	0.1...0.3 m	0.5...1.8 m	0.5...1.6 m	0.1...1.6 m
<b>1 mm SLIT</b>	-	-	-	-	-
<b>0,5 mm SLIT</b>	-	-	-	-	-

## TRANSPARENT RETROREFLECTIVE (SHORT RANGE: S100-T00)

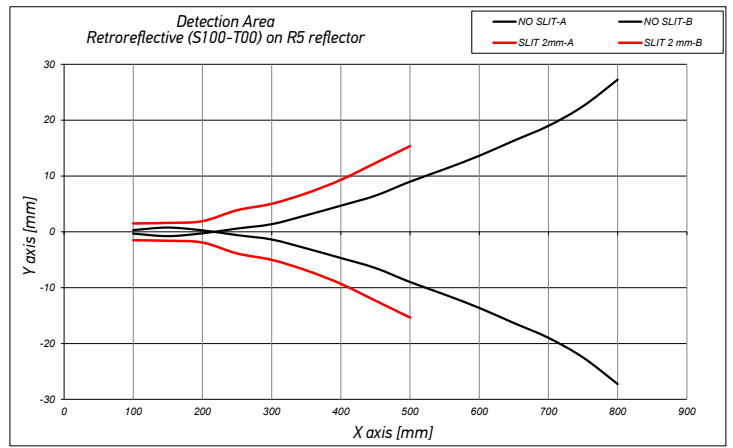
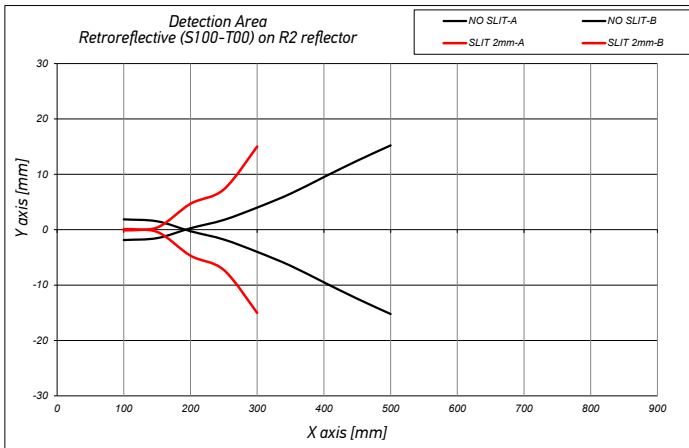

## TRANSPARENT RETROREFLECTIVE (LONG RANGE: S100-PR-5-T10-PH, ...OZ)

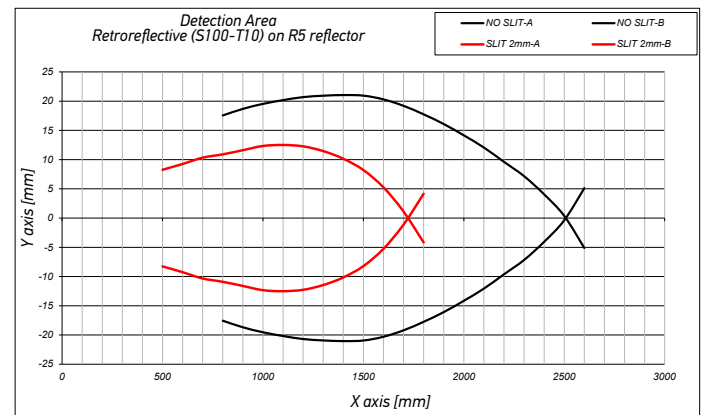
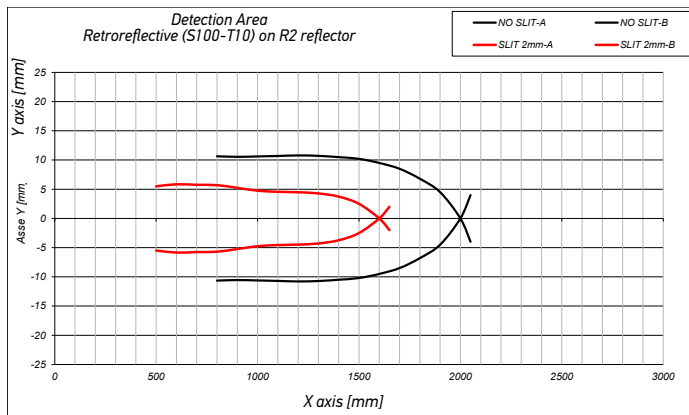

## BACKGROUND SUPPRESSION

Operating distances (background suppression)	30...100 mm	30...200 mm	
	S100...M00	S100...M10	S100...M10 
Maximum operating distance (White 90%)	0...150 mm	10...250 mm	10...210 mm
Maximum operating distance (Grey 18%)	10...110 mm	10...135 mm	10...180 mm
Maximum operating distance (Black 6%)	10...80 mm	10...110 mm	10...125 mm
Difference White 90%/White 90%	< 5%	< 10%	< 10%
Difference White 90%/Grey 18%	< 15%	< 32%	< 23%
Difference White 90%/Black 6%	< 25%	< 45%	< 35%

### BACKGROUND SUPPRESSION (SHORT RANGE: S100-M00)

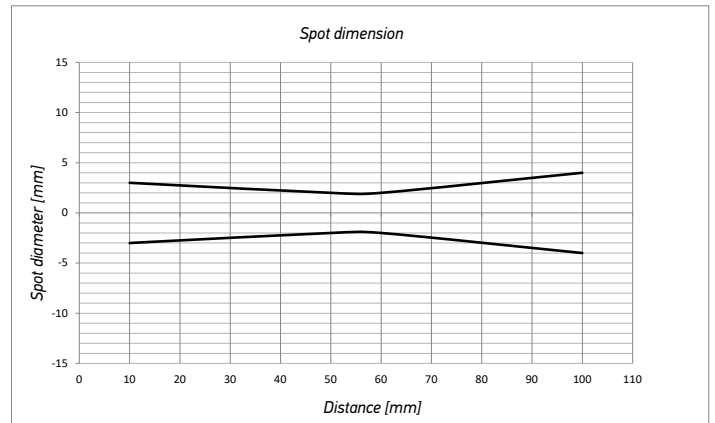
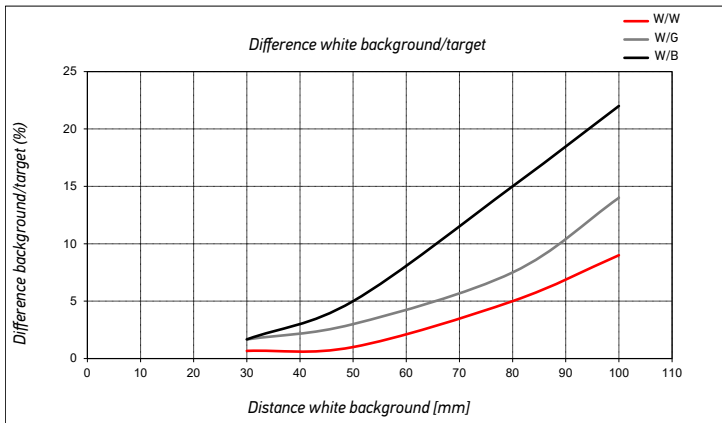

### BACKGROUND SUPPRESSION (LONG RANGE: S100-PR-5-M10-PH)

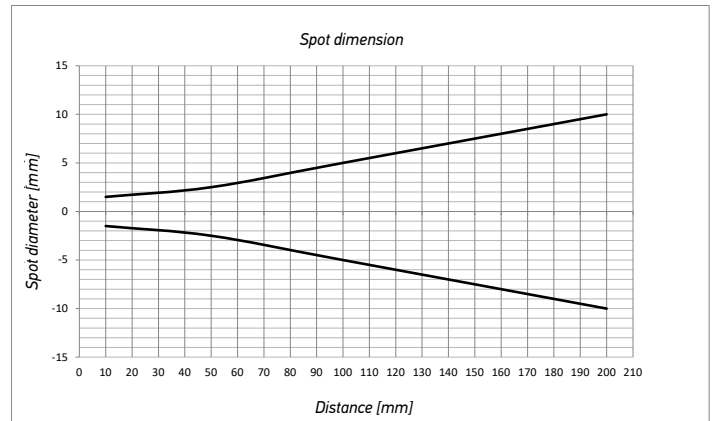
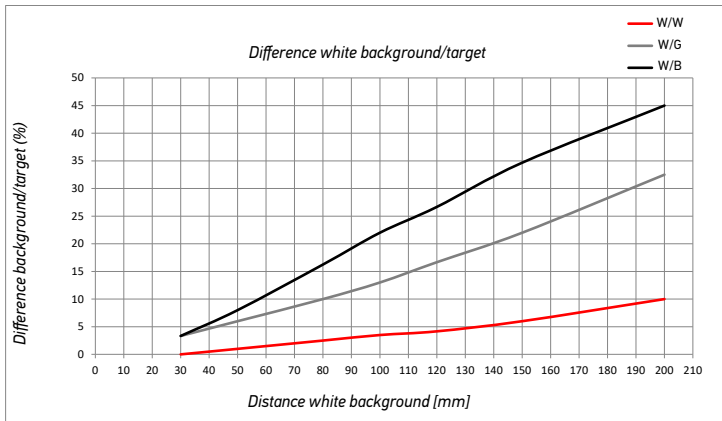

### BACKGROUND SUPPRESSION (LONG RANGE: S100-PR-5-M10-OZ)

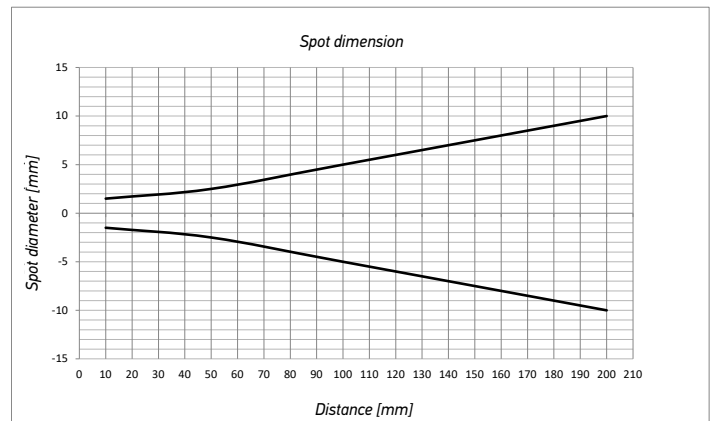
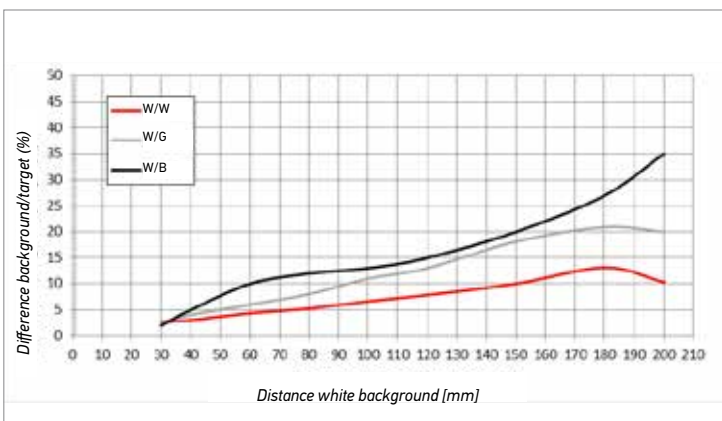



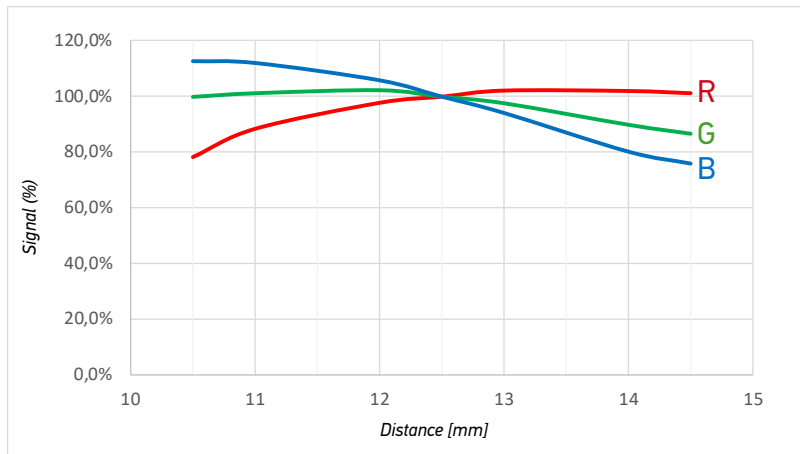

## MODEL SELECTION AND ORDER INFORMATION

OPTIC FUNCTION	EMISSION	OPERATING DISTANCE	CONNECTION	OUTPUT	MODEL	ORDER NO.
Through beam	IR	12 m	2 m cable	NPN	S100-PR-2-FG00-NK	950811100
				PNP	S100-PR-2-FG00-PK	950811110
			M8 connector	NPN	S100-PR-5-FG00-NK	950811240
				PNP	S100-PR-5-FG00-PK	950811250
Retroreflective	IR	7 m	2 m cable	NPN	S100-PR-2-A00-NK	950811000
				PNP	S100-PR-2-A00-PK	950811010
			M8 connector	NPN	S100-PR-5-A00-NK	950811140
				PNP	S100-PR-5-A00-PK	950811150
Polarized Retroreflective (short)	RED	2 m	2 m cable	NPN	S100-PR-2-B00-NK	950811020
				PNP	S100-PR-2-B00-PK	950811030
			M8 connector	NPN	S100-PR-5-B00-NK	950811160
				PNP	S100-PR-5-B00-PK	950811170
Polarized Retroreflective (long)	RED	5 m	2 m cable	NPN	S100-PR-2-B10-NK	950811280
				PNP	S100-PR-2-B10-PK	950811290
			M8 connector	NPN	S100-PR-5-B10-NK	950811300
				PNP	S100-PR-5-B10-PK	950811310
				S100-PR-5-B10-OZ	950810001	
Transparent Retroreflective (short)	IR	500 mm	2 m cable	NPN	S100-PR-2-T00-NH	950811330
				PNP	S100-PR-2-T00-PH	950811320
			M8 connector	NPN	S100-PR-5-T00-NH	950811350
				PNP	S100-PR-5-T00-PH	950811340
Transparent Retroreflective (long)	IR	2 m	2 m cable	NPN	S100-PR-2-T10-NH	950811370
				PNP	S100-PR-2-T10-PH	950811360
			M8 connector	NPN	S100-PR-5-T10-NH	950811390
				PNP	S100-PR-5-T10-PH	950811380
				S100-PR-5-T10-OZ	950810002	
Diffuse proximity (short)	RED	300 mm	2 m cable	NPN	S100-PR-2-C00-NK	950811040
				PNP	S100-PR-2-C00-PK	950811050
			M8 connector	NPN	S100-PR-5-C00-NK	950811180
				PNP	S100-PR-5-C00-PK	950811190
Diffuse proximity (long)	RED	500 mm	2 m cable	NPN	S100-PR-2-C10-NK	950811060
				PNP	S100-PR-2-C10-PK	950811070
			M8 connector	NPN	S100-PR-5-C10-NK	950811200
				PNP	S100-PR-5-C10-PK	950811210
Fixed focus	RED	70 mm	2 m cable	NPN	S100-PR-2-D00-NK	950811080
				PNP	S100-PR-2-D00-PK	950811090
			M8 connector	NPN	S100-PR-5-D00-NK	950811220
				PNP	S100-PR-5-D00-PK	950811230
Background suppression (short range)	RED	30...100 mm	2 m cable	NPN	S100-PR-2-M00-NH	950811120
				PNP	S100-PR-2-M00-PH	950811130
			M8 connector	NPN	S100-PR-5-M00-NH	950811260
				PNP	S100-PR-5-M00-PH	950811270
Background suppression (long range)	IR	30...200 mm	2 m cable	NPN	S100-PR-2-M10-NH	950811420
				PNP	S100-PR-2-M10-PH	950811430
			M8 connector	NPN	S100-PR-5-M10-NH	950811400
				PNP	S100-PR-5-M10-PH	950811410
				S100-PR-5-M10-OZ	950810003	
Mark Reader	RGB	12mm +/-2mm	M8 connector	PNP	S100-PR-5-W00-PK	950810005
					S100-PR-5-W00-OZ	950810004

# ACCESSORIES

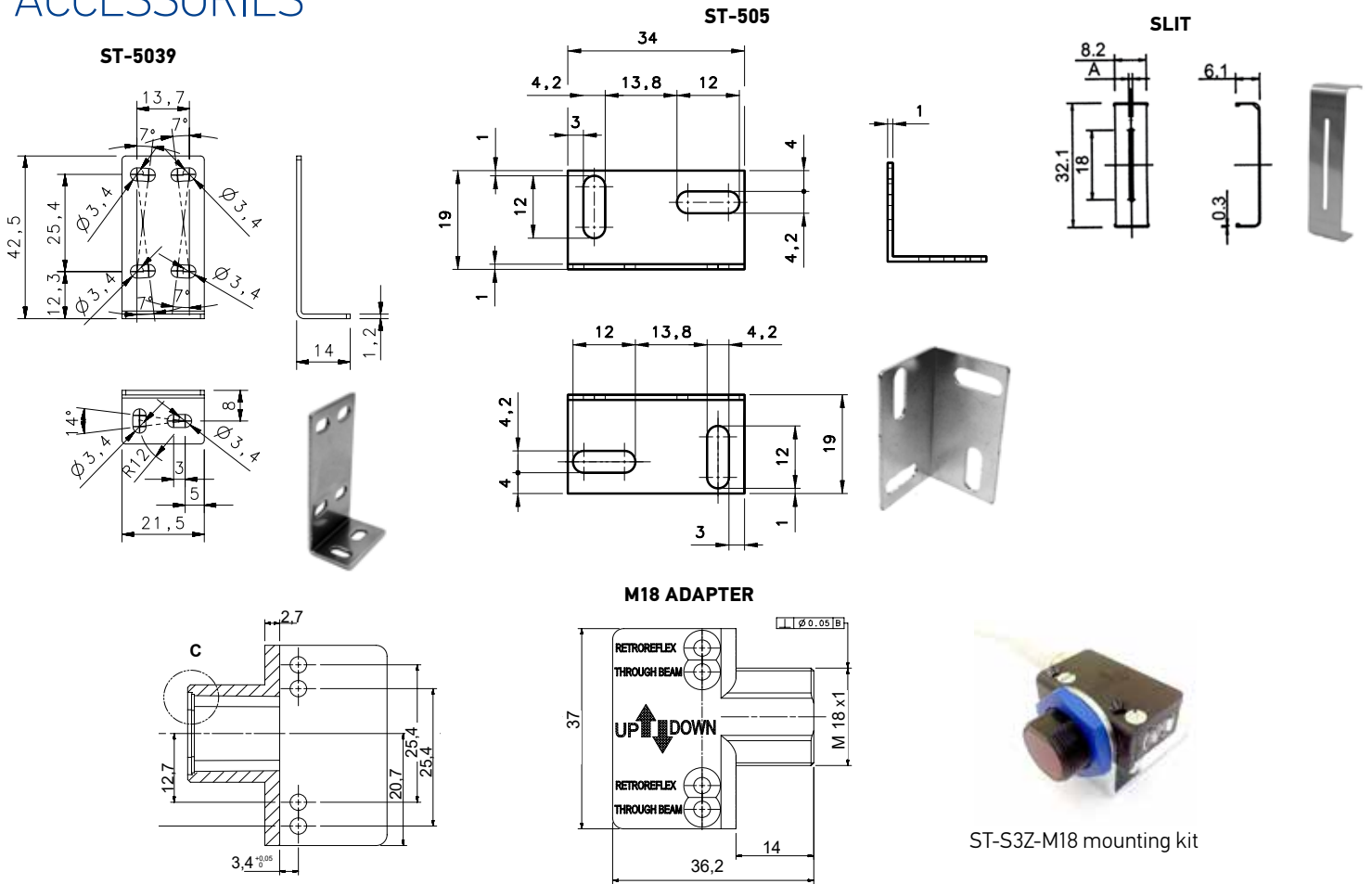

TYPE	MODEL	DESCRIPTION	ORDER NO.
Mounting bracket	ST-505	lateral mounting	95ACC2800
	ST-5039	L-shaped bracket	95ACC2270
Slit	S100-SLIT-05	0,5x19 mm SLIT	95ACC3450
	S100-SLIT-1	1x19 mm SLIT	95ACC3460
	S100-SLIT-2	2x19 mm SLIT	95ACC3470
M18 adapter	ST-S3Z-M18 mounting kit	M18 THREADED ADAPTER NOSE	95ACC7850

IO-LINK CONNECTIVITY		
MODEL	DESCRIPTION	ORDER No.
CBX-8IOL-EIP	CBX-8IOL-EIP 8P IOL M12 EIP MASTER	95ACC8180
CBX-8IOL-PNIO	CBX-8IOL-PNIO 8P IOL M12 PROFINET MASTER	95ACC8190

CABLES				
TYPE	DESCRIPTION	LENGTH	MODEL	ORDER NO.
Axial M8 Connector	4-pole, grey, P.V.C.	3 m	CS-B1-02-G-03	95A251420
		5 m	CS-B1-02-G-05	95A251430
		7 m	CS-B1-02-G-07	95A251440
		10 m	CS-B1-02-G-10	95A251480
Radial M8 Connector	4-pole, P.U.R.	2 m	CS-B1-02-R-02	95A251620
		5 m	CS-B1-02-R-05	95A251640
		10 m	CS-B1-02-R-10	95A251640
Radial M8 Connector	4-pole, grey, P.V.C.	3 m	CS-B2-02-G-03	95A251450
		5 m	CS-B2-02-G-05	95A251460
		7 m	CS-B2-02-G-07	95A251470
		10 m	CS-B2-02-G-10	95A251530
Axial M12 F/M8 M Connector	4-pole, P.U.R.	2 m	CS-B2-02-R-02	95A251630
		5 m	CS-B2-02-R-05	95A251650
Axial M12 F/M8 M Connector	4-pole, double headed	3 m	CS-H1-02-B-03	95ACC0008

Rev. 01, 03/2020

## DATALOGIC PRODUCT OFFERING

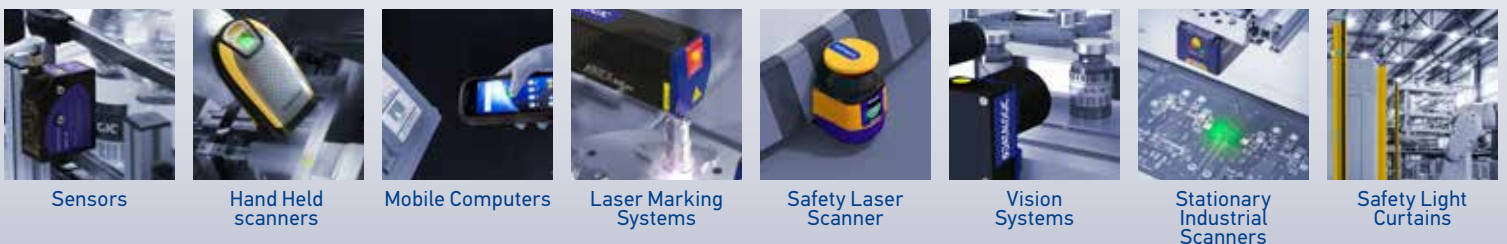

The company endeavours to continuously improve and renew its products; for this reason the technical data and contents of this catalogue may undergo variations without prior notice. For correct installation and use, the company can guarantee only the data indicated in the instruction manual supplied with the products. Product and Company names and logos referenced may be either trademarks or registered trademarks of their respective companies. We reserve the right to make modifications and improvements.