

# MC74LCX125

## Low-Voltage CMOS Quad Buffer

### With 5 V-Tolerant Inputs and Outputs (3-State, Non-Inverting)

The MC74LCX125 is a high performance, non-inverting quad buffer operating from a 2.3 to 3.6 V supply. High impedance TTL compatible inputs significantly reduce current loading to input drivers while TTL compatible outputs offer improved switching noise performance. A  $V_I$  specification of 5.5 V allows MC74LCX125 inputs to be safely driven from 5.0 V devices. The MC74LCX125 is suitable for memory address driving and all TTL level bus oriented transceiver applications.

Current drive capability is 24 mA at the outputs. The Output Enable ( $\overline{OE_n}$ ) inputs, when HIGH, disable the outputs by placing them in a HIGH Z condition.

#### Features

- Designed for 2.3 to 3.6 V  $V_{CC}$  Operation
- 5.0 V Tolerant – Interface Capability With 5.0 V TTL Logic
- Supports Live Insertion and Withdrawal
- $I_{OFF}$  Specification Guarantees High Impedance When  $V_{CC} = 0$  V
- LVTTL Compatible
- LVCMOS Compatible
- 24 mA Balanced Output Sink and Source Capability
- Near Zero Static Supply Current in all Three Logic States (10  $\mu$ A)  
Substantially Reduces System Power Requirements
- Latchup Performance Exceeds 500 mA
- ESD Performance: Human Body Model >2000 V  
Machine Model >200 V
- NLV Prefix for Automotive and Other Applications Requiring Unique Site and Control Change Requirements; AEC-Q100 Qualified and PPAP Capable
- These Devices are Pb-Free, Halogen Free/BFR Free and are RoHS Compliant



ON Semiconductor®

<http://onsemi.com>

#### MARKING DIAGRAMS

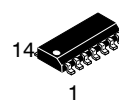

SOIC-14  
D SUFFIX  
CASE 751A

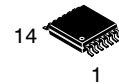
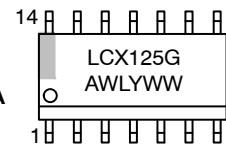

TSSOP-14  
DT SUFFIX  
CASE 948G

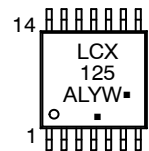

A = Assembly Location  
L, WL = Wafer Lot  
Y, YY = Year  
W, WW = Work Week  
G or ▪ = Pb-Free Package

(Note: Microdot may be in either location)

#### ORDERING INFORMATION

See detailed ordering and shipping information in the package dimensions section on page 4 of this data sheet.

# MC74LCX125

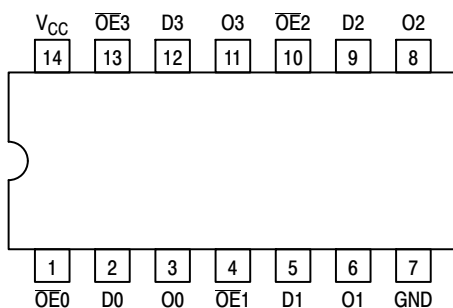

Figure 1. Pinout: 14-Lead (Top View)

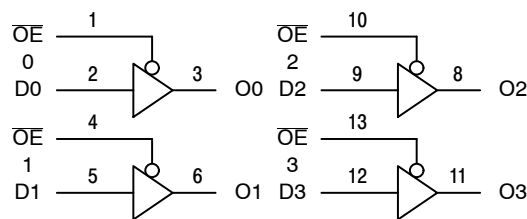

Figure 2. Logic Diagram

## PIN NAMES

Pins	Function
$\overline{OEn}$	Output Enable Inputs
$Dn$	Data Inputs
$On$	3-State Outputs

## TRUTH TABLE

INPUTS		OUTPUTS
$\overline{OEn}$	$Dn$	$On$
L	L	L
L	H	H
H	X	Z

H = High Voltage Level  
 L = Low Voltage Level  
 Z = High Impedance State  
 X = High or Low Voltage Level and Transitions Are Acceptable; for  $I_{CC}$  reasons, DO NOT FLOAT Inputs

## MAXIMUM RATINGS

Symbol	Parameter	Value	Condition	Units
$V_{CC}$	DC Supply Voltage	-0.5 to +7.0		V
$V_I$	DC Input Voltage	$-0.5 \leq V_I \leq +7.0$		V
$V_O$	DC Output Voltage	$-0.5 \leq V_O \leq +7.0$	Output in 3-State	V
		$-0.5 \leq V_O \leq V_{CC} + 0.5$	Output in HIGH or LOW State. (Note 1)	V
$I_{IK}$	DC Input Diode Current	-50	$V_I < GND$	mA
$I_{OK}$	DC Output Diode Current	-50	$V_O < GND$	mA
		+50	$V_O > V_{CC}$	mA
$I_O$	DC Output Source/Sink Current	$\pm 50$		mA
$I_{CC}$	DC Supply Current Per Supply Pin	$\pm 100$		mA
$I_{GND}$	DC Ground Current Per Ground Pin	$\pm 100$		mA
$T_{STG}$	Storage Temperature Range	-65 to +150		$^{\circ}C$
MSL	Moisture Sensitivity		Level 1	

Maximum ratings are those values beyond which device damage can occur. Maximum ratings applied to the device are individual stress limit values (not normal operating conditions) and are not valid simultaneously. If these limits are exceeded, device functional operation is not implied, damage may occur and reliability may be affected.

1.  $I_O$  absolute maximum rating must be observed.

# MC74LCX125

## RECOMMENDED OPERATING CONDITIONS

Symbol	Parameter	Min	Typ	Max	Units
$V_{CC}$	Supply Voltage Operating Data Retention Only	2.0 1.5	2.5, 3.3 2.5, 3.3	3.6 3.6	V
$V_I$	Input Voltage	0		5.5	V
$V_O$	Output Voltage HIGH or LOW State 3-State	0 0		$V_{CC}$ 5.5	V
$I_{OH}$	HIGH Level Output Current $V_{CC} = 3.0\text{ V} - 3.6\text{ V}$ $V_{CC} = 2.7\text{ V} - 3.0\text{ V}$ $V_{CC} = 2.3\text{ V} - 2.7\text{ V}$			-24 -12 -8	mA
$I_{OL}$	LOW Level Output Current $V_{CC} = 3.0\text{ V} - 3.6\text{ V}$ $V_{CC} = 2.7\text{ V} - 3.0\text{ V}$ $V_{CC} = 2.3\text{ V} - 2.7\text{ V}$			+24 +12 +8	mA
$T_A$	Operating Free-Air Temperature	-40		+85	°C
$\Delta t/\Delta V$	Input Transition Rise or Fall Rate, $V_{IN}$ from 0.8 V to 2.0 V, $V_{CC} = 3.0\text{ V}$	0		10	ns/V

## DC ELECTRICAL CHARACTERISTICS

Symbol	Characteristic	Condition	$T_A = -40^\circ\text{C to } +85^\circ\text{C}$		Units
			Min	Max	
$V_{IH}$	HIGH Level Input Voltage (Note 2)	$2.3\text{ V} \leq V_{CC} \leq 2.7\text{ V}$	1.7		V
		$2.7\text{ V} \leq V_{CC} \leq 3.6\text{ V}$	2.0		
$V_{IL}$	LOW Level Input Voltage (Note 2)	$2.3\text{ V} \leq V_{CC} \leq 2.7\text{ V}$		0.7	V
		$2.7\text{ V} \leq V_{CC} \leq 3.6\text{ V}$		0.8	
$V_{OH}$	HIGH Level Output Voltage	$2.3\text{ V} \leq V_{CC} \leq 3.6\text{ V}; I_{OL} = 100\ \mu\text{A}$	$V_{CC} - 0.2$		V
		$V_{CC} = 2.3\text{ V}; I_{OH} = -8\text{ mA}$	1.8		
		$V_{CC} = 2.7\text{ V}; I_{OH} = -12\text{ mA}$	2.2		
		$V_{CC} = 3.0\text{ V}; I_{OH} = -18\text{ mA}$	2.4		
		$V_{CC} = 3.0\text{ V}; I_{OH} = -24\text{ mA}$	2.2		
$V_{OL}$	LOW Level Output Voltage	$2.3\text{ V} \leq V_{CC} \leq 3.6\text{ V}; I_{OL} = 100\ \mu\text{A}$		0.2	V
		$V_{CC} = 2.3\text{ V}; I_{OL} = 8\text{ mA}$		0.6	
		$V_{CC} = 2.7\text{ V}; I_{OL} = 12\text{ mA}$		0.4	
		$V_{CC} = 3.0\text{ V}; I_{OL} = 16\text{ mA}$		0.4	
		$V_{CC} = 3.0\text{ V}; I_{OL} = 24\text{ mA}$		0.55	
$I_{OZ}$	3-State Output Current	$V_{CC} = 3.6\text{ V}, V_{IN} = V_{IH}\text{ or } V_{IL},$ $V_{OUT} = 0\text{ to } 5.5\text{ V}$		$\pm 5$	$\mu\text{A}$
$I_{OFF}$	Power Off Leakage Current	$V_{CC} = 0, V_{IN} = 5.5\text{ V or } V_{OUT} = 5.5\text{ V}$		10	$\mu\text{A}$
$I_{IN}$	Input Leakage Current	$V_{CC} = 3.6\text{ V}, V_{IN} = 5.5\text{ V or GND}$		$\pm 5$	$\mu\text{A}$
$I_{CC}$	Quiescent Supply Current	$V_{CC} = 3.6\text{ V}, V_{IN} = 5.5\text{ V or GND}$		10	$\mu\text{A}$
$\Delta I_{CC}$	Increase in $I_{CC}$ per Input	$2.3 \leq V_{CC} \leq 3.6\text{ V}; V_{IH} = V_{CC} - 0.6\text{ V}$		500	$\mu\text{A}$

2. These values of  $V_I$  are used to test DC electrical characteristics only.

# MC74LCX125

## AC CHARACTERISTICS ( $t_R = t_F = 2.5 \text{ ns}$ ; $R_L = 500 \Omega$ )

Symbol	Parameter	Waveform	Limits						Units
			$T_A = -40^\circ\text{C to } +85^\circ\text{C}$						
			$V_{CC} = 3.3 \text{ V} \pm 0.3 \text{ V}$		$V_{CC} = 2.7 \text{ V}$		$V_{CC} = 2.5 \text{ V} \pm 0.2 \text{ V}$		
			$C_L = 50 \text{ pF}$		$C_L = 50 \text{ pF}$		$C_L = 30 \text{ pF}$		
			Min	Max	Min	Max	Min	Max	
$t_{PLH}$ $t_{PHL}$	Propagation Delay Time Input to Output	1	1.5 1.5	6.0 6.0	1.5 1.5	6.5 6.5	1.5 1.5	7.2 7.2	ns
$t_{PZH}$ $t_{PZL}$	Output Enable Time to High and Low Level	2	1.5 1.5	7.0 7.0	1.5 1.5	8.0 8.0	1.5 1.5	9.1 9.1	ns
$t_{PHZ}$ $t_{PLZ}$	Output Disable Time From High and Low Level	2	1.5 1.5	6.0 6.0	1.5 1.5	7.0 7.0	1.5 1.5	7.2 7.2	ns
$t_{OSHL}$ $t_{OSLH}$	Output-to-Output Skew (Note 3)			1.0 1.0					ns

3. Skew is defined as the absolute value of the difference between the actual propagation delay for any two separate outputs of the same device. The specification applies to any outputs switching in the same direction, either HIGH-to-LOW ( $t_{OSHL}$ ) or LOW-to-HIGH ( $t_{OSLH}$ ); parameter guaranteed by design.

## DYNAMIC SWITCHING CHARACTERISTICS

Symbol	Characteristic	Condition	$T_A = +25^\circ\text{C}$			Units
			Min	Typ	Max	
$V_{OLP}$	Dynamic LOW Peak Voltage (Note 4)	$V_{CC} = 3.3 \text{ V}, C_L = 50 \text{ pF}, V_{IH} = 3.3 \text{ V}, V_{IL} = 0 \text{ V}$ $V_{CC} = 2.5 \text{ V}, C_L = 30 \text{ pF}, V_{IH} = 2.5 \text{ V}, V_{IL} = 0 \text{ V}$		0.8 0.6		V
$V_{OLV}$	Dynamic LOW Valley Voltage (Note 4)	$V_{CC} = 3.3 \text{ V}, C_L = 50 \text{ pF}, V_{IH} = 3.3 \text{ V}, V_{IL} = 0 \text{ V}$ $V_{CC} = 2.5 \text{ V}, C_L = 30 \text{ pF}, V_{IH} = 2.5 \text{ V}, V_{IL} = 0 \text{ V}$		-0.8 -0.6		V

4. Number of outputs defined as "n". Measured with "n-1" outputs switching from HIGH-to-LOW or LOW-to-HIGH. The remaining output is measured in the LOW state.

## CAPACITIVE CHARACTERISTICS

Symbol	Parameter	Condition	Typical	Units
$C_{IN}$	Input Capacitance	$V_{CC} = 3.3 \text{ V}, V_I = 0 \text{ V or } V_{CC}$	7	pF
$C_{OUT}$	Output Capacitance	$V_{CC} = 3.3 \text{ V}, V_I = 0 \text{ V or } V_{CC}$	8	pF
$C_{PD}$	Power Dissipation Capacitance	10 MHz, $V_{CC} = 3.3 \text{ V}, V_I = 0 \text{ V or } V_{CC}$	25	pF

## ORDERING INFORMATION

Device	Package	Shipping <sup>†</sup>
MC74LCX125DG	SOIC-14 (Pb-Free)	55 Units / Rail
MC74LCX125DR2G	SOIC-14 (Pb-Free)	2500 Tape & Reel
MC74LCX125DTG	TSSOP-14 (Pb-Free)	96 Units / Rail
MC74LCX125DTR2G	TSSOP-14 (Pb-Free)	2500 Tape & Reel
NLVLCX125DTR2G	TSSOP-14* (Pb-Free)	2500 Tape & Reel

<sup>†</sup>For information on tape and reel specifications, including part orientation and tape sizes, please refer to our Tape and Reel Packaging Specifications Brochure, BRD8011/D.

\*NLV Prefix for Automotive and Other Applications Requiring Unique Site and Control Change Requirements; AEC-Q100 Qualified.

# MC74LCX125

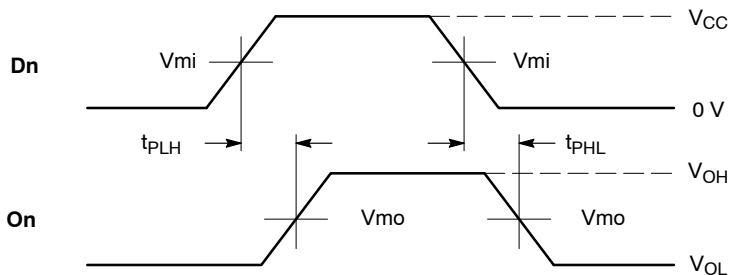

**WAVEFORM 1 - PROPAGATION DELAYS**

$t_R = t_F = 2.5 \text{ ns}$ , 10% to 90%;  $f = 1 \text{ MHz}$ ;  $t_W = 500 \text{ ns}$

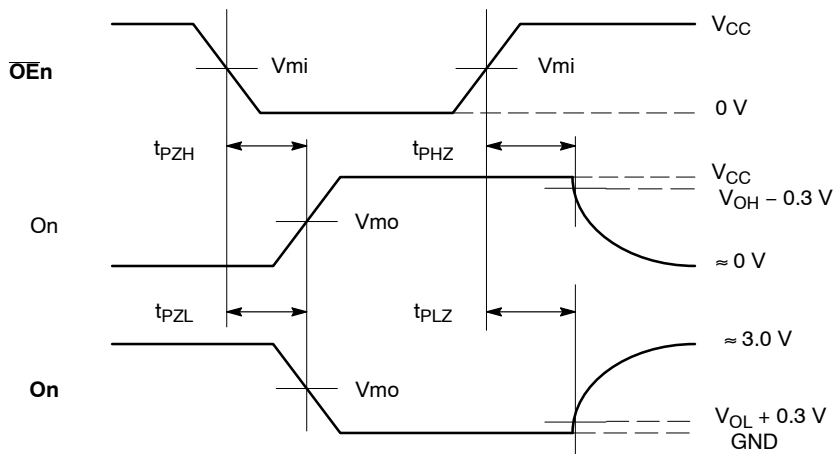

**WAVEFORM 2 - OUTPUT ENABLE AND DISABLE TIMES**

$t_R = t_F = 2.5 \text{ ns}$ , 10% to 90%;  $f = 1 \text{ MHz}$ ;  $t_W = 500 \text{ ns}$

Symbol	$V_{CC}$		
	$3.3 \text{ V} \pm 0.3 \text{ V}$	$2.7 \text{ V}$	$2.5 \text{ V} \pm 0.2 \text{ V}$
Vmi	1.5 V	1.5 V	$V_{CC}/2$
Vmo	1.5 V	1.5 V	$V_{CC}/2$

**Figure 3. AC Waveforms**

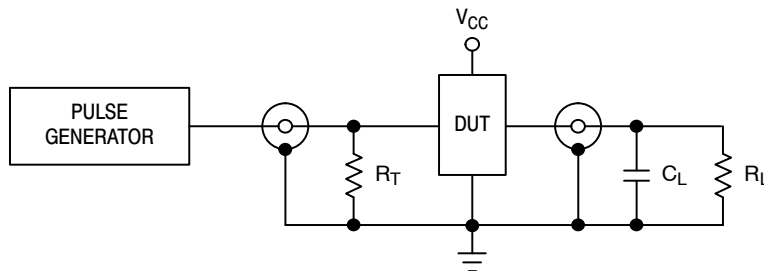

$C_L = 50 \text{ pF}$  at  $V_{CC} = 3.3 \pm 0.3 \text{ V}$  or equivalent (includes jig and probe capacitance)  
 $C_L = 30 \text{ pF}$  at  $V_{CC} = 2.5 \pm 0.2 \text{ V}$  or equivalent (includes jig and probe capacitance)  
 $R_L = R_1 = 500 \Omega$  or equivalent  
 $R_T = Z_{OUT}$  of pulse generator (typically  $50 \Omega$ )

**Figure 4. Test Circuit**

# MECHANICAL CASE OUTLINE PACKAGE DIMENSIONS



SCALE 1:1

SOIC-14 NB  
CASE 751A-03  
ISSUE L

DATE 03 FEB 2016



NOTES:

1. DIMENSIONING AND TOLERANCING PER ASME Y14.5M, 1994.
2. CONTROLLING DIMENSION: MILLIMETERS.
3. DIMENSION b DOES NOT INCLUDE DAMBAR PROTRUSION. ALLOWABLE PROTRUSION SHALL BE 0.13 TOTAL IN EXCESS OF AT MAXIMUM MATERIAL CONDITION.
4. DIMENSIONS D AND E DO NOT INCLUDE MOLD PROTRUSIONS.
5. MAXIMUM MOLD PROTRUSION 0.15 PER SIDE.

DIM	MILLIMETERS		INCHES	
	MIN	MAX	MIN	MAX
A	1.35	1.75	0.054	0.068
A1	0.10	0.25	0.004	0.010
A3	0.19	0.25	0.008	0.010
b	0.35	0.49	0.014	0.019
D	8.55	8.75	0.337	0.344
E	3.80	4.00	0.150	0.157
e	1.27 BSC		0.050 BSC	
H	5.80	6.20	0.228	0.244
h	0.25	0.50	0.010	0.019
L	0.40	1.25	0.016	0.049
M	0°	7°	0°	7°

SOLDERING FOOTPRINT\*



DIMENSIONS: MILLIMETERS

\*For additional information on our Pb-Free strategy and soldering details, please download the ON Semiconductor Soldering and Mounting Techniques Reference Manual, SOLDERRM/D.

GENERIC MARKING DIAGRAM\*



- XXXXXX = Specific Device Code
- A = Assembly Location
- WL = Wafer Lot
- Y = Year
- WW = Work Week
- G = Pb-Free Package

\*This information is generic. Please refer to device data sheet for actual part marking. Pb-Free indicator, "G" or microdot "▪", may or may not be present. Some products may not follow the Generic Marking.

STYLES ON PAGE 2

DOCUMENT NUMBER:	98ASB42565B	Electronic versions are uncontrolled except when accessed directly from the Document Repository. Printed versions are uncontrolled except when stamped "CONTROLLED COPY" in red.
DESCRIPTION:	SOIC-14 NB	PAGE 1 OF 2

onsemi and ONSEMI are trademarks of Semiconductor Components Industries, LLC dba onsemi or its subsidiaries in the United States and/or other countries. onsemi reserves the right to make changes without further notice to any products herein. onsemi makes no warranty, representation or guarantee regarding the suitability of its products for any particular purpose, nor does onsemi assume any liability arising out of the application or use of any product or circuit, and specifically disclaims any and all liability, including without limitation special, consequential or incidental damages. onsemi does not convey any license under its patent rights nor the rights of others.

**SOIC-14**  
**CASE 751A-03**  
**ISSUE L**

DATE 03 FEB 2016

STYLE 1:  
 PIN 1. COMMON CATHODE  
 2. ANODE/CATHODE  
 3. ANODE/CATHODE  
 4. NO CONNECTION  
 5. ANODE/CATHODE  
 6. NO CONNECTION  
 7. ANODE/CATHODE  
 8. ANODE/CATHODE  
 9. ANODE/CATHODE  
 10. NO CONNECTION  
 11. ANODE/CATHODE  
 12. ANODE/CATHODE  
 13. NO CONNECTION  
 14. COMMON ANODE

STYLE 2:  
 CANCELLED

STYLE 3:  
 PIN 1. NO CONNECTION  
 2. ANODE  
 3. ANODE  
 4. NO CONNECTION  
 5. ANODE  
 6. NO CONNECTION  
 7. ANODE  
 8. ANODE  
 9. ANODE  
 10. NO CONNECTION  
 11. ANODE  
 12. ANODE  
 13. NO CONNECTION  
 14. COMMON CATHODE

STYLE 4:  
 PIN 1. NO CONNECTION  
 2. CATHODE  
 3. CATHODE  
 4. NO CONNECTION  
 5. CATHODE  
 6. NO CONNECTION  
 7. CATHODE  
 8. CATHODE  
 9. CATHODE  
 10. NO CONNECTION  
 11. CATHODE  
 12. CATHODE  
 13. NO CONNECTION  
 14. COMMON ANODE

STYLE 5:  
 PIN 1. COMMON CATHODE  
 2. ANODE/CATHODE  
 3. ANODE/CATHODE  
 4. ANODE/CATHODE  
 5. ANODE/CATHODE  
 6. NO CONNECTION  
 7. COMMON ANODE  
 8. COMMON CATHODE  
 9. ANODE/CATHODE  
 10. ANODE/CATHODE  
 11. ANODE/CATHODE  
 12. ANODE/CATHODE  
 13. NO CONNECTION  
 14. COMMON ANODE

STYLE 6:  
 PIN 1. CATHODE  
 2. CATHODE  
 3. CATHODE  
 4. CATHODE  
 5. CATHODE  
 6. CATHODE  
 7. CATHODE  
 8. ANODE  
 9. ANODE  
 10. ANODE  
 11. ANODE  
 12. ANODE  
 13. ANODE  
 14. ANODE

STYLE 7:  
 PIN 1. ANODE/CATHODE  
 2. COMMON ANODE  
 3. COMMON CATHODE  
 4. ANODE/CATHODE  
 5. ANODE/CATHODE  
 6. ANODE/CATHODE  
 7. ANODE/CATHODE  
 8. ANODE/CATHODE  
 9. ANODE/CATHODE  
 10. ANODE/CATHODE  
 11. COMMON CATHODE  
 12. COMMON ANODE  
 13. ANODE/CATHODE  
 14. ANODE/CATHODE

STYLE 8:  
 PIN 1. COMMON CATHODE  
 2. ANODE/CATHODE  
 3. ANODE/CATHODE  
 4. NO CONNECTION  
 5. ANODE/CATHODE  
 6. ANODE/CATHODE  
 7. COMMON ANODE  
 8. COMMON ANODE  
 9. ANODE/CATHODE  
 10. ANODE/CATHODE  
 11. NO CONNECTION  
 12. ANODE/CATHODE  
 13. ANODE/CATHODE  
 14. COMMON CATHODE

<b>DOCUMENT NUMBER:</b>	<b>98ASB42565B</b>	Electronic versions are uncontrolled except when accessed directly from the Document Repository. Printed versions are uncontrolled except when stamped "CONTROLLED COPY" in red.
<b>DESCRIPTION:</b>	<b>SOIC-14 NB</b>	<b>PAGE 2 OF 2</b>

**onsemi** and **ONSEMI** are trademarks of Semiconductor Components Industries, LLC dba **onsemi** or its subsidiaries in the United States and/or other countries. **onsemi** reserves the right to make changes without further notice to any products herein. **onsemi** makes no warranty, representation or guarantee regarding the suitability of its products for any particular purpose, nor does **onsemi** assume any liability arising out of the application or use of any product or circuit, and specifically disclaims any and all liability, including without limitation special, consequential or incidental damages. **onsemi** does not convey any license under its patent rights nor the rights of others.

**onsemi**, **Onsemi**, and other names, marks, and brands are registered and/or common law trademarks of Semiconductor Components Industries, LLC dba "**onsemi**" or its affiliates and/or subsidiaries in the United States and/or other countries. **onsemi** owns the rights to a number of patents, trademarks, copyrights, trade secrets, and other intellectual property. A listing of **onsemi**'s product/patent coverage may be accessed at [www.onsemi.com/site/pdf/Patent-Marking.pdf](http://www.onsemi.com/site/pdf/Patent-Marking.pdf). **onsemi** reserves the right to make changes at any time to any products or information herein, without notice. The information herein is provided "as-is" and **onsemi** makes no warranty, representation or guarantee regarding the accuracy of the information, product features, availability, functionality, or suitability of its products for any particular purpose, nor does **onsemi** assume any liability arising out of the application or use of any product or circuit, and specifically disclaims any and all liability, including without limitation special, consequential or incidental damages. Buyer is responsible for its products and applications using **onsemi** products, including compliance with all laws, regulations and safety requirements or standards, regardless of any support or applications information provided by **onsemi**. "Typical" parameters which may be provided in **onsemi** data sheets and/or specifications can and do vary in different applications and actual performance may vary over time. All operating parameters, including "Typicals" must be validated for each customer application by customer's technical experts. **onsemi** does not convey any license under any of its intellectual property rights nor the rights of others. **onsemi** products are not designed, intended, or authorized for use as a critical component in life support systems or any FDA Class 3 medical devices or medical devices with a same or similar classification in a foreign jurisdiction or any devices intended for implantation in the human body. Should Buyer purchase or use **onsemi** products for any such unintended or unauthorized application, Buyer shall indemnify and hold **onsemi** and its officers, employees, subsidiaries, affiliates, and distributors harmless against all claims, costs, damages, and expenses, and reasonable attorney fees arising out of, directly or indirectly, any claim of personal injury or death associated with such unintended or unauthorized use, even if such claim alleges that **onsemi** was negligent regarding the design or manufacture of the part. **onsemi** is an Equal Opportunity/Affirmative Action Employer. This literature is subject to all applicable copyright laws and is not for resale in any manner.

## ADDITIONAL INFORMATION

### TECHNICAL PUBLICATIONS:

Technical Library: [www.onsemi.com/design/resources/technical-documentation](http://www.onsemi.com/design/resources/technical-documentation)  
onsemi Website: [www.onsemi.com](http://www.onsemi.com)

### ONLINE SUPPORT: [www.onsemi.com/support](http://www.onsemi.com/support)

For additional information, please contact your local Sales Representative at [www.onsemi.com/support/sales](http://www.onsemi.com/support/sales)