



Octal Transparent Latch With Active Low Enable 3-State Outputs

ELECTRICALLY TESTED PER:
MIL-M-38510/34601

The 54F373 consists of eight latches with 3-state outputs for bus organized system applications. The flip-flops appear transparent to the data when Latch Enable (LE) is HIGH. When LE is LOW, the data that meets setup time is latched. Data appears on the bus when the Output Enable (\overline{OE}) is LOW. When \overline{OE} is HIGH the bus output is in the high impedance state.

- Eight Latches in a Single Package
- 3-State Outputs for Bus Interfacing

LOGIC DIAGRAM

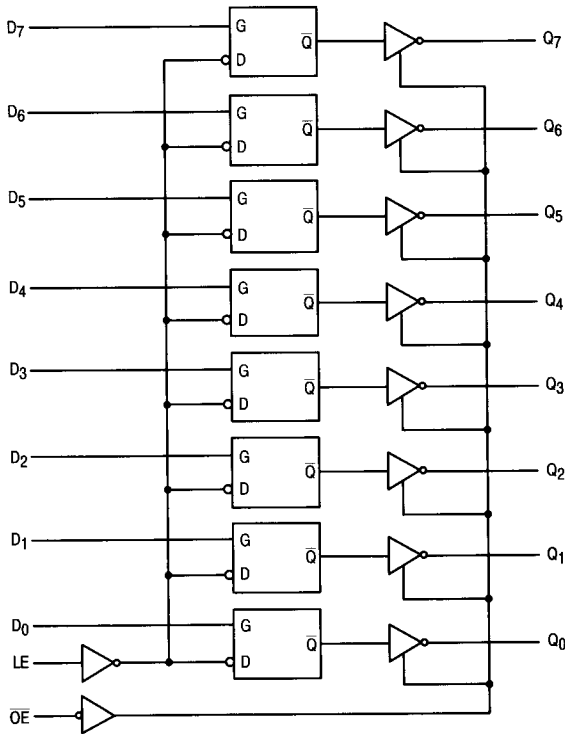

Military 54F373



AVAILABLE AS:

- 1) JAN: JM38510/34601BXA
- 2) SMD: N/A
- 3) 883: 54F373/BXAJC

X = CASE OUTLINE AS FOLLOWS:
PACKAGE: CERDIP: R
CERFLAT: S
LCC: 2

THE LETTER "M" APPEARS
BEFORE THE / ON LCC.

PIN ASSIGNMENTS

FUNCT.	DIL 732-03	FLATS 737-02	LCC 756A-02	BURN-IN (COND. A)
\overline{OE}	1	1	1	VCC
Q ₀	2	2	2	OPEN
D ₀	3	3	3	VCC
D ₁	4	4	4	VCC
Q ₁	5	5	5	OPEN
Q ₂	6	6	6	OPEN
D ₂	7	7	7	VCC
D ₃	8	8	8	VCC
Q ₃	9	9	9	OPEN
GND	10	10	10	GND
LE	11	11	11	VCC
Q ₄	12	12	12	OPEN
D ₄	13	13	13	VCC
D ₅	14	14	14	VCC
Q ₅	15	15	15	OPEN
Q ₆	16	16	16	OPEN
D ₆	17	17	17	VCC
D ₇	18	18	18	VCC
Q ₇	19	19	19	OPEN
VCC	20	20	20	VCC

BURN-IN CONDITIONS:
VCC = 5.0 V MIN/6.0 V MAX

FUNCTIONAL DESCRIPTION

The 'F373 contains eight D-type latches with 3-state output buffers. When the Latch Enable (LE) input is HIGH, data on the D_n inputs enters the latches. In this condition the latches are transparent, i.e., a latch will change state each time its D input changes. When LE is LOW the latches store the information that was present on the D inputs at setup time preceding the

HIGH-to-LOW transition of the LE. The 3-state buffers are controlled by the Output Enable (\overline{OE}) input. When \overline{OE} is LOW, the buffers are in the bi-state mode. When \overline{OE} is HIGH, the buffers are in the high impedance mode but this does not interfere with entering new data into the latches.

TRUTH TABLE			
Inputs			Output
D_n	LE	\overline{OE}	Q_n
H	H	L	H
L	H	L	L
X	H	H	Z

H = HIGH Voltage Level
 L = LOW Voltage Level
 X = Immaterial
 Z = HIGH Impedance

CONNECTION DIAGRAM

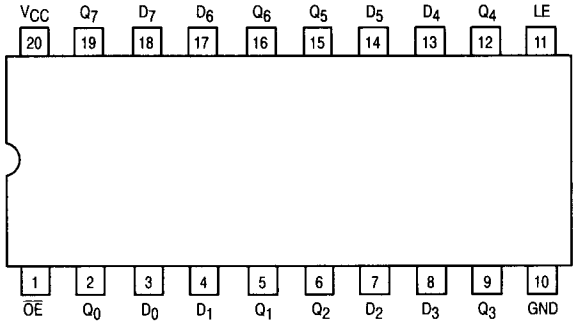

AC TEST CIRCUIT

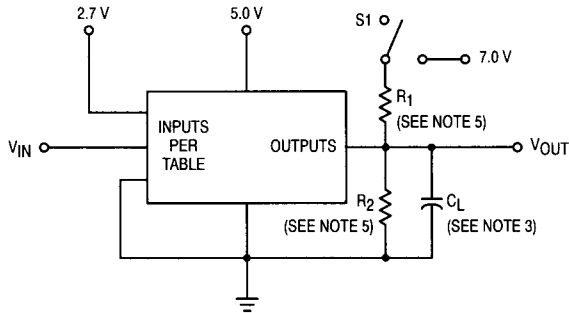

Test Type	S1
t_{PLH}	open
t_{PHL}	open
t_{PHZ}	open
t_{PZH}	open
t_{PLZ}	closed
t_{PZL}	closed

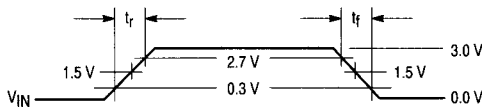

REFERENCE NOTES ON PAGE 4-165

54F373

WAVEFORMS

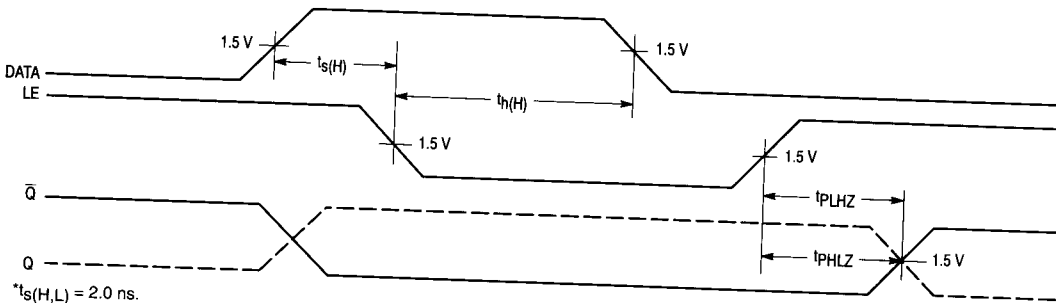
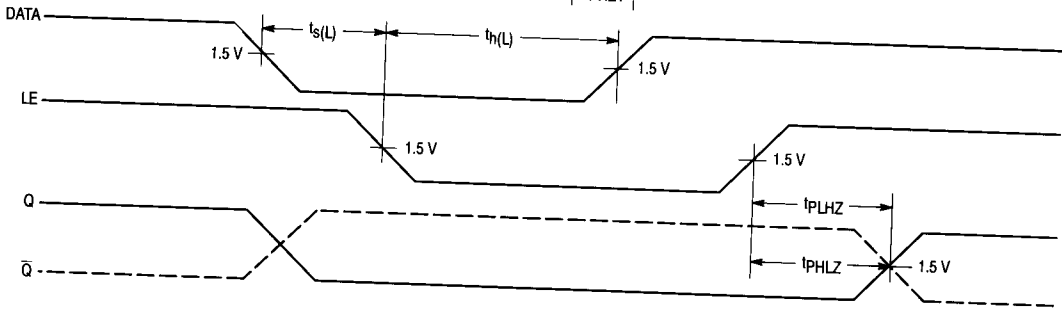
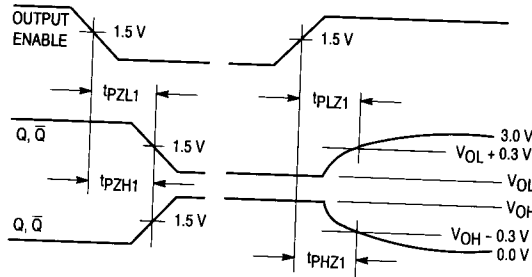
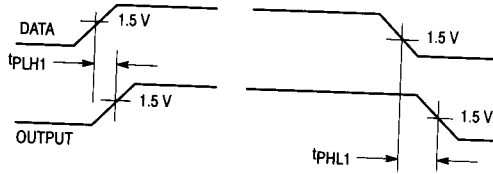
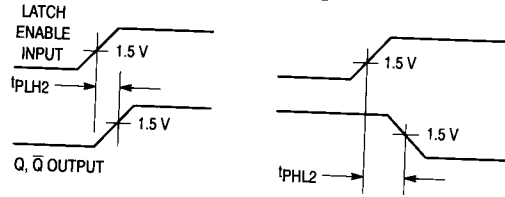

* $t_{s(H,L)} = 2.0$ ns.

* $t_{h(H,L)} = 3.0$ ns.

*Setup and Hold times are for information only. No testing required.

54F373

Symbol	Parameter	Limits						Unit	Test Condition (Unless Otherwise Specified)
		+ 25°C		+ 125°C		- 55°C			
		Subgroup 1		Subgroup 2		Subgroup 3			
		Min	Max	Min	Max	Min	Max		
V _{OH}	Logical "1" Output Voltage	2.5		2.5		2.5		V	V _{CC} = 4.5 V, I _{OH} = -1.0 mA, V _{IH} = 2.0 V, other inputs are open, \overline{OE} = 0.8 V, LE = 2.0 V.
V _{OL}	Logical "0" Output Voltage		0.5		0.5		0.5	V	V _{CC} = 4.5 V, I _{OL} = 20 mA, V _{IL} = 0.8 V, other inputs are open, LE = 2.0 V, \overline{OE} = 0.8 V.
V _{IC}	Input Clamping Voltage		-1.2					V	V _{CC} = 4.5 V, I _{IN} = -18 mA, other inputs are open.
I _{IH}	Logical "1" Input Current		20		20		20	μA	V _{CC} = 4.5 V, V _{IH} = 2.7 V, other inputs are open.
I _{IHH}	Logical "1" Input Current		100		100		100	μA	V _{CC} = 5.5 V, V _{IHH} = 7.0 V, other inputs are open.
I _{OD}	Diode Current	35		35		35		mA	V _{CC} = 4.5 V, V _{IN} = 0 V, other inputs are open, LE = 5.5 V, \overline{OE} = 0 V, V _{OUT} = 2.5 V.
I _{IL}	Logical "0" Input Current	-0.03	-0.6	-0.03	-0.6	-0.03	-0.6	mA	V _{CC} = 5.5 V, V _{IN} = 0.5 V, other inputs are open.
I _{OS}	Output Short Circuit Current	-60	-150	-60	-150	-60	-150	mA	V _{CC} = 5.5 V, V _{IN} = 4.5 V, other inputs are open, V _{OUT} = 0 V, LE = 5.5 V, \overline{OE} = 0 V.
I _{IOZH}	Output Off Current High		50		50		50	μA	V _{CC} = 5.5 V, V _{IN} = 0 V, other inputs are open, V _{OUT} = 2.4 V, \overline{OE} = 2.0 V, LE = 5.5 V.
I _{IOZL}	Output Off Current Low		-50		-50		-50	μA	V _{CC} = 5.5 V, V _{IN} = 5.5 V, other inputs are open, V _{OUT} = 0.5 V, \overline{OE} = 2.0 V, LE = 5.5 V.
I _{CCH}	Power Supply Current On		55		55		55	mA	V _{CC} = 5.5 V, V _{IN} = 5.5 V (all inputs), LE = 5.5 V, \overline{OE} = 0 V.
I _{CCL}	Power Supply Current Off		60		60		60	mA	V _{CC} = 5.5 V, V _{IN} = 0 V (all inputs), LE = 5.5 V, \overline{OE} = 0 V.
I _{CCZ}	Power Supply Current Off		60		60		60	mA	V _{CC} = 5.5 V, all inputs are open, LE & \overline{OE} = 5.5 V.
V _{IH}	Logical "1" Input Voltage	2.0		2.0		2.0		V	V _{CC} = 4.5 V.
V _{IL}	Logical "0" Input Voltage		0.8		0.8		0.8	V	V _{CC} = 4.5 V.
	Functional Tests	Subgroup 7		Subgroup 8A		Subgroup 8B			per Truth Table with V _{CC} = 4.5 V, (Repeat at) V _{CC} = 5.5 V, V _{INL} = 0.5 V, and V _{INH} = 2.5 V.

54F373

Symbol	Parameter	Limits						Unit	Test Condition (Unless Otherwise Specified)
		+ 25°C		+ 125°C		- 55°C			
		Subgroup 9		Subgroup 10		Subgroup 11			
		Min	Max	Min	Max	Min	Max		
t _{PHL1}	Propagation Delay /Data-Output D _n to Q _n	2.0	5.0	2.0	7.0	2.0	7.0	ns	V _{CC} = 5.0 V, C _L = 50 pF, R ₁ = R ₂ = 499 Ω.
t _{PLH1}	Propagation Delay /Data-Output D _n to Q _n	3.0	7.0	3.0	8.5	3.0	8.5	ns	V _{CC} = 5.0 V, C _L = 50 pF, R ₁ = R ₂ = 499 Ω.
t _{PHL2}	Propagation Delay /Data-Output LE to Q _n	3.0	7.0	3.0	8.5	3.0	8.5	ns	V _{CC} = 5.0 V, C _L = 50 pF, R ₁ = R ₂ = 499 Ω.
t _{PLH2}	Propagation Delay /Data-Output LE to Q _n	5.0	11.5	5.0	15	5.0	15	ns	V _{CC} = 5.0 V, C _L = 50 pF, R ₁ = R ₂ = 499 Ω.
t _{PLZ1}	Output Disable Time, \overline{OE} to Q _n	1.5	6.5	1.5	7.0	1.5	7.0	ns	V _{CC} = 5.0 V, C _L = 50 pF, R ₁ = R ₂ = 499 Ω.
t _{PHZ1}	Output Disable Time, \overline{OE} to Q _n	1.5	6.5	1.5	10	1.5	10	ns	V _{CC} = 5.0 V, C _L = 50 pF, R ₁ = R ₂ = 499 Ω.
t _{PZL1}	Output Enable Time, OE to Q _n	2.0	7.5	2.0	10	2.0	10	ns	V _{CC} = 5.0 V, C _L = 50 pF, R ₁ = R ₂ = 499 Ω.
t _{PZH1}	Output Enable Time, OE to Q _n	2.0	11	2.0	15	2.0	15	ns	V _{CC} = 5.0 V, C _L = 50 pF, R ₁ = R ₂ = 499 Ω.

NOTES:

1. Input has the following characteristics: $t_r = t_f \leq 2.5$ ns, PRR ≤ 1.0 MHz, Z_{OUT} = 50 Ω
2. Terminal conditions (pins not designated may be high ≥ 2.0 V, low ≤ 0.8 V, or open).
3. C_L = 50 pF $\pm 10\%$ including scope probe, wiring and stray capacitance, without package in test fixture.
4. Voltage measurements are to be made with respect to network ground terminal.
5. R₁ = R₂ = 499 Ω $\pm 5.0\%$.