

DM54LS73A,DM74LS73A

*DM54LS73A DM74LS73A Dual Negative-Edge-Triggered Master-Slave J-K
Flip-Flops with Clear and Complementary Outputs*



Literature Number: SNOS312A

DM54LS73A/DM74LS73A Dual Negative-Edge-Triggered Master-Slave J-K Flip-Flops with Clear and Complementary Outputs

General Description

This device contains two independent negative-edge-triggered J-K flip-flops with complementary outputs. The J and K data is processed by the flip-flops on the falling edge of the clock pulse. The clock triggering occurs at a voltage level and is not directly related to the transition time of the negative going edge of the clock pulse. The data on the J

and K inputs is allowed to change while the clock is high or low without affecting the outputs as long as setup and hold times are not violated. A low logic level on the clear input will reset the outputs regardless of the levels of the other inputs.

Connection Diagram

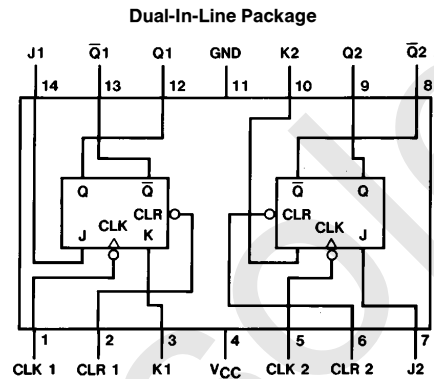

TL/F/6372-1

Order Number DM54LS73AJ, DM54LS73AW, DM74LS73AM or DM74LS73AN
See NS Package Number J14A, M14A, N14A or W14B

Function Table

Inputs				Outputs	
CLR	CLK	J	K	Q	\bar{Q}
L	X	X	X	L	H
H	↓	L	L	Q_0	\bar{Q}_0
H	↓	H	L	H	L
H	↓	L	H	L	H
H	↓	H	H	Toggle	
H	H	X	X	Q_0	\bar{Q}_0

H = High Logic Level

L = Low Logic Level

X = Either Low or High Logic Level

↓ = Negative going edge of pulse.

Q_0 = The output logic level before the indicated input conditions were established.

Toggle = Each output changes to the complement of its previous level on each falling edge of the clock pulse.

DM54LS73A/DM74LS73A Dual Negative-Edge-Triggered Master-Slave J-K Flip-Flops with Clear and Complementary Outputs

Absolute Maximum Ratings (Note)

If Military/Aerospace specified devices are required, please contact the National Semiconductor Sales Office/Distributors for availability and specifications.

Supply Voltage	7V
Input Voltage	7V
Operating Free Air Temperature Range	
DM54LS	-55°C to +125°C
DM74LS	0°C to +70°C
Storage Temperature Range	-65°C to +150°C

Note: The "Absolute Maximum Ratings" are those values beyond which the safety of the device cannot be guaranteed. The device should not be operated at these limits. The parametric values defined in the "Electrical Characteristics" table are not guaranteed at the absolute maximum ratings. The "Recommended Operating Conditions" table will define the conditions for actual device operation.

Recommended Operating Conditions

Symbol	Parameter	DM54LS73A			DM74LS73A			Units
		Min	Nom	Max	Min	Nom	Max	
V _{CC}	Supply Voltage	4.5	5	5.5	4.75	5	5.25	V
V _{IH}	High Level Input Voltage	2			2			V
V _{IL}	Low Level Input Voltage			0.7			0.8	V
I _{OH}	High Level Output Current			-0.4			-0.4	mA
I _{OL}	Low Level Output Current			4			8	mA
f _{CLK}	Clock Frequency (Note 2)	0		30	0		30	MHz
f _{CLK}	Clock Frequency (Note 3)	0		25	0		25	MHz
t _w	Pulse Width (Note 2)	Clock High	20		20			ns
		Preset Low	25		25			
		Clear Low	25		25			
t _w	Pulse Width (Note 3)	Clock High	25		25			ns
		Preset Low	30		30			
		Clear Low	30		30			
t _{SU}	Setup Time (Notes 1 and 2)	20 ↓			20 ↓			ns
t _{SU}	Setup Time (Notes 1 and 3)	25 ↓			25 ↓			ns
t _H	Hold Time (Notes 1 and 2)	0 ↓			0 ↓			ns
t _H	Hold Time (Notes 1 and 3)	5 ↓			5 ↓			ns
T _A	Free Air Operating Temperature	-55		125	0		70	°C

Note 1: The symbol (↓) indicates the falling edge of the clock pulse is used for reference.

Note 2: C_L = 15 pF, R_L = 2 kΩ, T_A = 25°C and V_{CC} = 5V.

Note 3: C_L = 50 pF, R_L = 2 kΩ, T_A = 25°C and V_{CC} = 5V.

Electrical Characteristics

over recommended operating free air temperature range (unless otherwise noted)

Symbol	Parameter	Conditions	Min	Typ (Note 1)	Max	Units
V_I	Input Clamp Voltage	$V_{CC} = \text{Min}, I_I = -18 \text{ mA}$			-1.5	V
V_{OH}	High Level Output Voltage	$V_{CC} = \text{Min}, I_{OH} = \text{Max}$ $V_{IL} = \text{Max}, V_{IH} = \text{Min}$	DM54	2.5	3.4	V
			DM74	2.7	3.4	
V_{OL}	Low Level Output Voltage	$V_{CC} = \text{Min}, I_{OL} = \text{Max}$ $V_{IL} = \text{Max}, V_{IH} = \text{Min}$	DM54		0.25	V
			DM74		0.35	
			$I_{OL} = 4 \text{ mA}, V_{CC} = \text{Min}$	DM74		
I_I	Input Current @ Max Input Voltage	$V_{CC} = \text{Max}$ $V_I = 7\text{V}$	J, K		0.1	mA
			Clear		0.3	
			Clock		0.4	
I_{IH}	High Level Input Current	$V_{CC} = \text{Max}$ $V_I = 2.7\text{V}$	J, K		20	μA
			Clear		60	
			Clock		80	
I_{IL}	Low Level Input Current	$V_{CC} = \text{Max}$ $V_I = 0.4\text{V}$	J, K		-0.4	mA
			Clear		-0.8	
			Clock		-0.8	
I_{OS}	Short Circuit Output Current	$V_{CC} = \text{Max}$ (Note 2)	DM54	-20	-100	mA
			DM74	-20	-100	
I_{CC}	Supply Current	$V_{CC} = \text{Max}$ (Note 3)		4	6	mA

Switching Characteristics

at $V_{CC} = 5\text{V}$ and $T_A = 25^\circ\text{C}$ (See Section 1 for Test Waveforms and Output Load)

Symbol	Parameter	From (Input) To (Output)	$R_L = 2 \text{ k}\Omega$				Units
			$C_L = 15 \text{ pF}$		$C_L = 50 \text{ pF}$		
			Min	Max	Min	Max	
f_{MAX}	Maximum Clock Frequency		30		25		MHz
t_{PHL}	Propagation Delay Time High to Low Level Output	Clear to Q		20		28	ns
t_{PLH}	Propagation Delay Time Low to High Level Output	Clear to \bar{Q}		20		24	ns
t_{PLH}	Propagation Delay Time Low to High Level Output	Clock to Q or \bar{Q}		20		24	ns
t_{PHL}	Propagation Delay Time High to Low Level Output	Clock to Q or \bar{Q}		20		28	ns

Note 1: All typicals are at $V_{CC} = 5\text{V}$, $T_A = 25^\circ\text{C}$.

Note 2: Not more than one output should be shorted at a time, and the duration should not exceed one second. For devices, with feedback from the outputs, where shorting the outputs to ground may cause the outputs to change logic state, an equivalent test may be performed where $V_O = 2.25\text{V}$ and 2.125V for DM54 and DM74 series, respectively, with the minimum and maximum limits reduced by one half from their stated values. This is very useful when using automatic test equipment.

Note 3: With all outputs open, I_{CC} is measured with the Q and \bar{Q} outputs high in turn. At the time of measurement, the clock is grounded.

Physical Dimensions inches (millimeters)

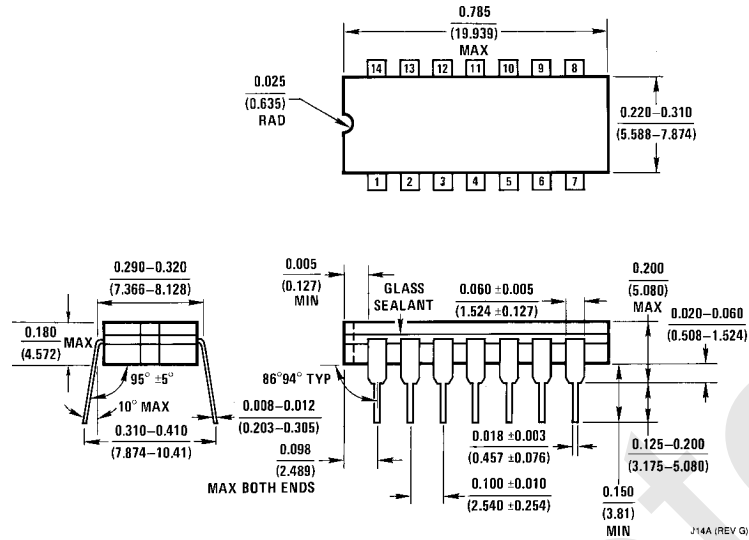

14-Lead Ceramic Dual-In-Line Package (J)
Order Number DM54LS73AJ
NS Package Number J14A

Physical Dimensions inches (millimeters) (Continued)

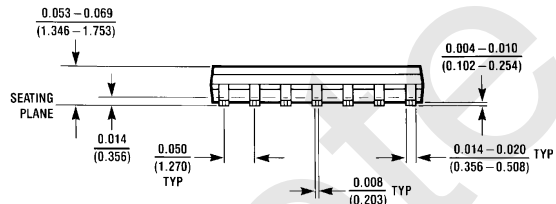
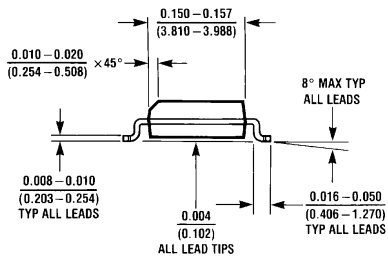
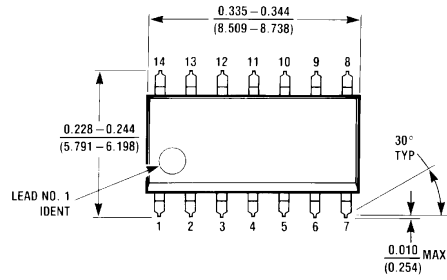

M14A (REV HI)

14-Lead Small Outline Molded Package (M)
Order Number DM74LS73AM
NS Package Number M14A

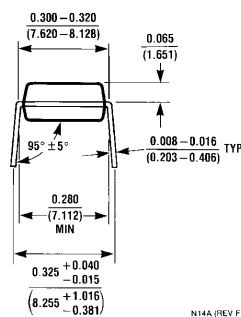
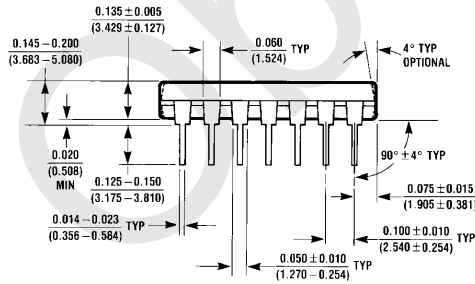
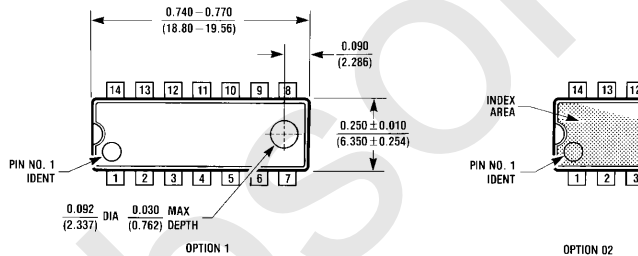

N14A (REV F)

14-Lead Molded Dual-In-Line Package (N)
Order Number DM74LS73AN
NS Package Number N14A

**DM54LS73A/DM74LS73A Dual Negative-Edge-Triggered
Master-Slave J-K Flip-Flops with Clear and Complementary Outputs**

Physical Dimensions inches (millimeters) (Continued)

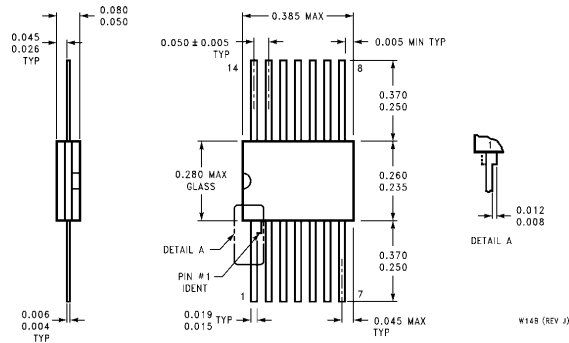

**14-Lead Ceramic Flat Package (W)
Order Number DM54LS73AW
NS Package Number W14B**

LIFE SUPPORT POLICY

NATIONAL'S PRODUCTS ARE NOT AUTHORIZED FOR USE AS CRITICAL COMPONENTS IN LIFE SUPPORT DEVICES OR SYSTEMS WITHOUT THE EXPRESS WRITTEN APPROVAL OF THE PRESIDENT OF NATIONAL SEMICONDUCTOR CORPORATION. As used herein:

1. Life support devices or systems are devices or systems which, (a) are intended for surgical implant into the body, or (b) support or sustain life, and whose failure to perform, when properly used in accordance with instructions for use provided in the labeling, can be reasonably expected to result in a significant injury to the user.
2. A critical component is any component of a life support device or system whose failure to perform can be reasonably expected to cause the failure of the life support device or system, or to affect its safety or effectiveness.



National Semiconductor Corporation
1111 West Bardin Road
Arlington, TX 76017
Tel: 1(800) 272-9959
Fax: 1(800) 737-7018

National Semiconductor Europe
Fax: (+49) 0-180-530 85 86
Email: cnjwge@tevm2.nsc.com
Deutsch Tel: (+49) 0-180-530 85 85
English Tel: (+49) 0-180-532 78 32
Français Tel: (+49) 0-180-532 93 58
Italiano Tel: (+49) 0-180-534 16 80

National Semiconductor Hong Kong Ltd.
19th Floor, Straight Block,
Ocean Centre, 5 Canton Rd.
Tsimshatsui, Kowloon
Hong Kong
Tel: (852) 2737-1600
Fax: (852) 2736-9960

National Semiconductor Japan Ltd.
Tel: 81-043-299-2309
Fax: 81-043-299-2408

National does not assume any responsibility for use of any circuitry described, no circuit patent licenses are implied and National reserves the right at any time without notice to change said circuitry and specifications.

IMPORTANT NOTICE

Texas Instruments Incorporated and its subsidiaries (TI) reserve the right to make corrections, modifications, enhancements, improvements, and other changes to its products and services at any time and to discontinue any product or service without notice. Customers should obtain the latest relevant information before placing orders and should verify that such information is current and complete. All products are sold subject to TI's terms and conditions of sale supplied at the time of order acknowledgment.

TI warrants performance of its hardware products to the specifications applicable at the time of sale in accordance with TI's standard warranty. Testing and other quality control techniques are used to the extent TI deems necessary to support this warranty. Except where mandated by government requirements, testing of all parameters of each product is not necessarily performed.

TI assumes no liability for applications assistance or customer product design. Customers are responsible for their products and applications using TI components. To minimize the risks associated with customer products and applications, customers should provide adequate design and operating safeguards.

TI does not warrant or represent that any license, either express or implied, is granted under any TI patent right, copyright, mask work right, or other TI intellectual property right relating to any combination, machine, or process in which TI products or services are used. Information published by TI regarding third-party products or services does not constitute a license from TI to use such products or services or a warranty or endorsement thereof. Use of such information may require a license from a third party under the patents or other intellectual property of the third party, or a license from TI under the patents or other intellectual property of TI.

Reproduction of TI information in TI data books or data sheets is permissible only if reproduction is without alteration and is accompanied by all associated warranties, conditions, limitations, and notices. Reproduction of this information with alteration is an unfair and deceptive business practice. TI is not responsible or liable for such altered documentation. Information of third parties may be subject to additional restrictions.

Resale of TI products or services with statements different from or beyond the parameters stated by TI for that product or service voids all express and any implied warranties for the associated TI product or service and is an unfair and deceptive business practice. TI is not responsible or liable for any such statements.

TI products are not authorized for use in safety-critical applications (such as life support) where a failure of the TI product would reasonably be expected to cause severe personal injury or death, unless officers of the parties have executed an agreement specifically governing such use. Buyers represent that they have all necessary expertise in the safety and regulatory ramifications of their applications, and acknowledge and agree that they are solely responsible for all legal, regulatory and safety-related requirements concerning their products and any use of TI products in such safety-critical applications, notwithstanding any applications-related information or support that may be provided by TI. Further, Buyers must fully indemnify TI and its representatives against any damages arising out of the use of TI products in such safety-critical applications.

TI products are neither designed nor intended for use in military/aerospace applications or environments unless the TI products are specifically designated by TI as military-grade or "enhanced plastic." Only products designated by TI as military-grade meet military specifications. Buyers acknowledge and agree that any such use of TI products which TI has not designated as military-grade is solely at the Buyer's risk, and that they are solely responsible for compliance with all legal and regulatory requirements in connection with such use.

TI products are neither designed nor intended for use in automotive applications or environments unless the specific TI products are designated by TI as compliant with ISO/TS 16949 requirements. Buyers acknowledge and agree that, if they use any non-designated products in automotive applications, TI will not be responsible for any failure to meet such requirements.

Following are URLs where you can obtain information on other Texas Instruments products and application solutions:

Products

Audio	www.ti.com/audio
Amplifiers	amplifier.ti.com
Data Converters	dataconverter.ti.com
DLP® Products	www.dlp.com
DSP	dsp.ti.com
Clocks and Timers	www.ti.com/clocks
Interface	interface.ti.com
Logic	logic.ti.com
Power Mgmt	power.ti.com
Microcontrollers	microcontroller.ti.com
RFID	www.ti-rfid.com
OMAP Mobile Processors	www.ti.com/omap
Wireless Connectivity	www.ti.com/wirelessconnectivity

Applications

Communications and Telecom	www.ti.com/communications
Computers and Peripherals	www.ti.com/computers
Consumer Electronics	www.ti.com/consumer-apps
Energy and Lighting	www.ti.com/energy
Industrial	www.ti.com/industrial
Medical	www.ti.com/medical
Security	www.ti.com/security
Space, Avionics and Defense	www.ti.com/space-avionics-defense
Transportation and Automotive	www.ti.com/automotive
Video and Imaging	www.ti.com/video

TI E2E Community Home Page

e2e.ti.com

Mailing Address: Texas Instruments, Post Office Box 655303, Dallas, Texas 75265
Copyright © 2011, Texas Instruments Incorporated