

QUADRUPLE 2-INPUT NAND SCHMITT TRIGGER

The HEF4093B consists of four Schmitt-trigger circuits. Each circuit functions as a two-input NAND gate with Schmitt-trigger action on both inputs. The gate switches at different points for positive and negative-going signals. The difference between the positive voltage (V_P) and the negative voltage (V_N) is defined as hysteresis voltage (V_H).

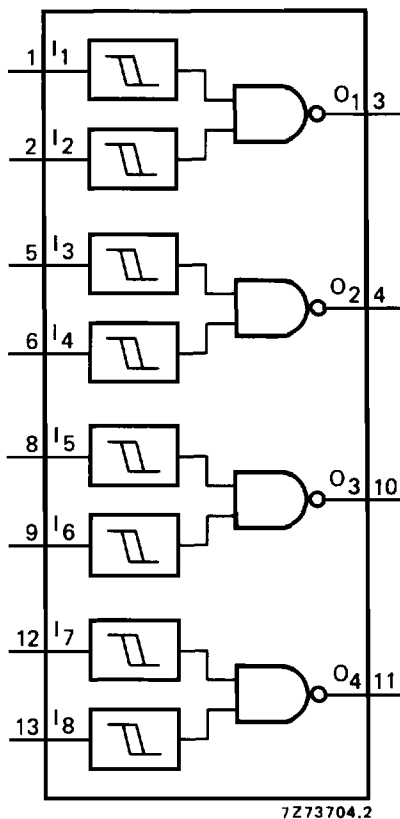

Fig. 1 Functional diagram.

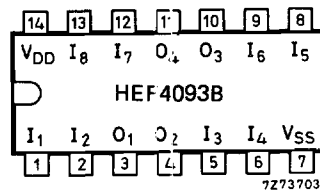

Fig. 2 Pinning diagram.

HEF4093BP(N): 14-lead DIL; plastic (SOT27-1)
 HEF4093BD(F): 14-lead DIL; ceramic (cerdip) (SOT73)
 HEF4093BT(D): 14-lead SO; plastic (SOT108-1)
 (): Package Designator North America

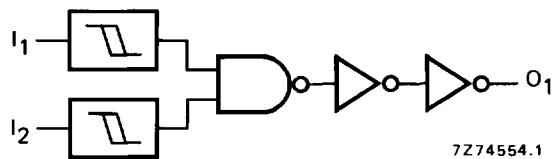

Fig. 3 Logic diagram (one gate).

FAMILY DATA

I_{DD} LIMITS category GATES

} see Family Specifications

D.C. CHARACTERISTICS

 $V_{SS} = 0 \text{ V}$; $T_{amb} = 25 \text{ }^\circ\text{C}$

	V_{DD} V	symbol	min.	typ.	max.	
Hysteresis voltage	5	V_H	0,4	0,7	—	V
	10		0,6	1,0	—	V
	15		0,7	1,3	—	V
Switching levels positive-going input voltage	5	V_P	1,9	2,9	3,5	V
	10		3,6	5,2	7	V
	15		4,7	7,3	11	V
negative-going input voltage	5	V_N	1,5	2,2	3,1	V
	10		3	4,2	6,4	V
	15		4	6,0	10,3	V

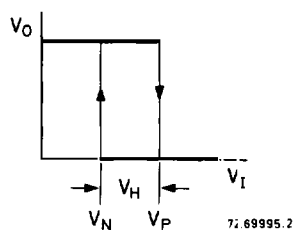
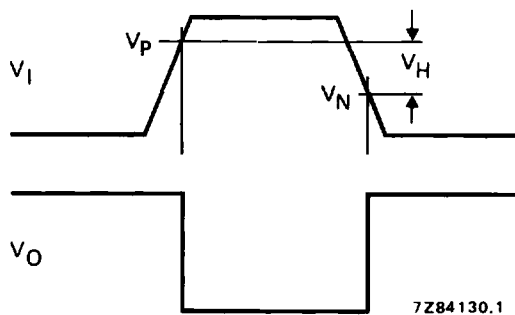

Fig. 4 Transfer characteristic.

Fig. 5 Waveforms showing definition of V_P , V_N and V_H ; where V_N and V_P are between limits of 30% and 70%.

A.C. CHARACTERISTICS

$V_{SS} = 0\text{ V}$; $T_{amb} = 25\text{ }^{\circ}\text{C}$; $C_L = 50\text{ pF}$; input transition times $\leq 20\text{ ns}$

	V_{DD} V	symbol	typ.	max.		typical extrapolation formula	
Propagation delays $I_n \rightarrow O_n$ HIGH to LOW	5	t _{PHL}	90	185	ns	$63\text{ ns} + (0,55\text{ ns/pF}) C_L$	
	10		40	80	ns	$29\text{ ns} + (0,23\text{ ns/pF}) C_L$	
	15		30	60	ns	$22\text{ ns} + (0,16\text{ ns/pF}) C_L$	
	LOW to HIGH	5	t _{PLH}	85	170	ns	$58\text{ ns} + (0,55\text{ ns/pF}) C_L$
		10		40	80	ns	$29\text{ ns} + (0,23\text{ ns/pF}) C_L$
		15		30	60	ns	$22\text{ ns} + (0,16\text{ ns/pF}) C_L$
Output transition times HIGH to LOW	5	t _{THL}	60	120	ns	$10\text{ ns} + (1,0\text{ ns/pF}) C_L$	
	10		30	60	ns	$9\text{ ns} + (0,42\text{ ns/pF}) C_L$	
	15		20	40	ns	$6\text{ ns} + (0,28\text{ ns/pF}) C_L$	
	LOW to HIGH	5	t _{TLH}	60	120	ns	$10\text{ ns} + (1,0\text{ ns/pF}) C_L$
		10		30	60	ns	$9\text{ ns} + (0,42\text{ ns/pF}) C_L$
		15		20	40	ns	$6\text{ ns} + (0,28\text{ ns/pF}) C_L$

	V_{DD} V	typical formula for P (μW)	where
Dynamic power dissipation per package (P)	5	$1300 f_i + \Sigma(f_o C_L) \times V_{DD}^2$	f_i = input freq. (MHz)
	10	$6400 f_i + \Sigma(f_o C_L) \times V_{DD}^2$	f_o = output freq. (MHz)
	15	$18700 f_i + \Sigma(f_o C_L) \times V_{DD}^2$	C_L = load capacitance (pF)
			$\Sigma(f_o C_L)$ = sum of outputs
			V_{DD} = supply voltage (V)

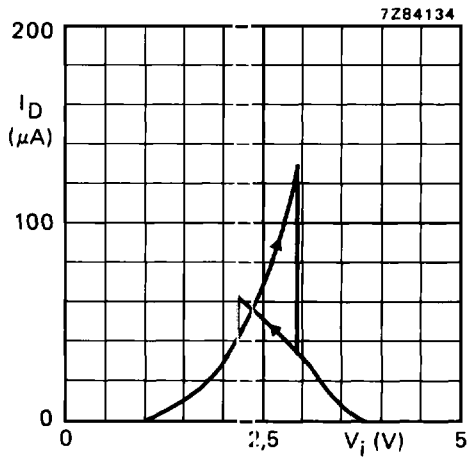

Fig. 6 Typical drain current as a function of input voltage; $V_{DD} = 5\text{ V}$; $T_{amb} = 25\text{ }^\circ\text{C}$.

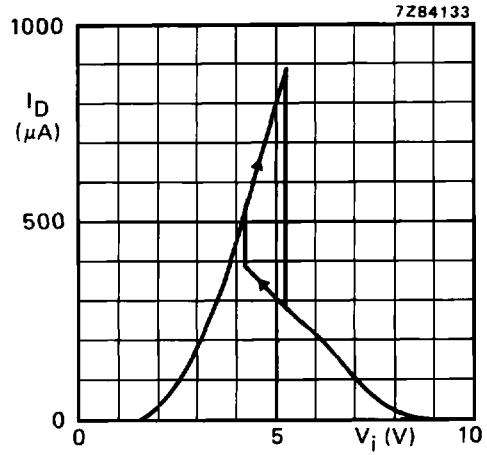

Fig. 7 Typical drain current as a function of input voltage; $V_{DD} = 10\text{ V}$; $T_{amb} = 25\text{ }^\circ\text{C}$.

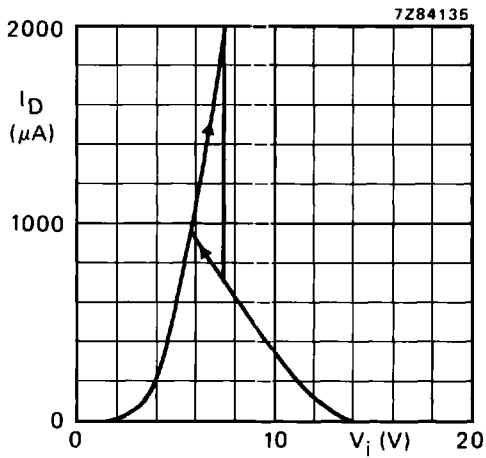

Fig. 8 Typical drain current as a function of input voltage; $V_{DD} = 15\text{ V}$; $T_{amb} = 25\text{ }^\circ\text{C}$.

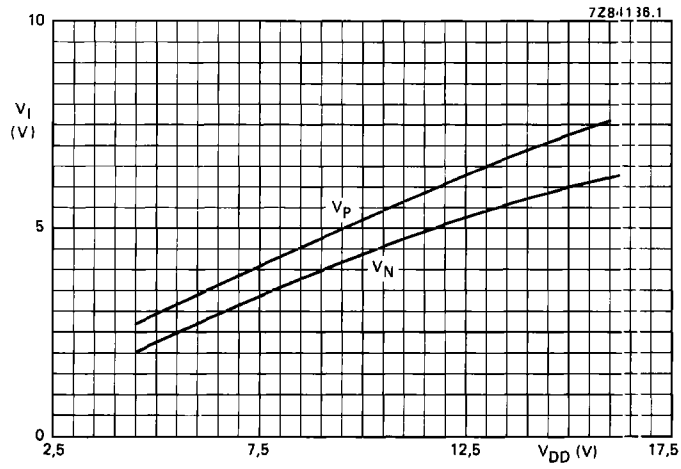

Fig. 9 Typical switching levels as a function of supply voltage V_{DD} ; $T_{amb} = 25\text{ }^{\circ}\text{C}$.

APPLICATION INFORMATION

Some examples of applications for the HEF4093B are:

- Wave and pulse shapers
- Astable multivibrators
- Monostable multivibrators.

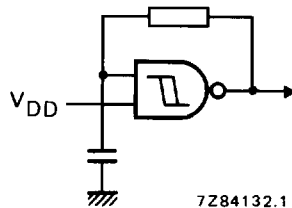

Fig. 10 The HEF4093B used as a astable multivibrator.

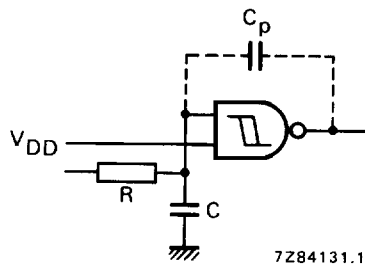

Fig. 11 Schmitt trigger driven via a high impedance ($R > 1 \text{ k}\Omega$).

If a Schmitt trigger is driven via a high impedance ($R > 1 \text{ k}\Omega$) then it is necessary to incorporate a capacitor C of such value that: $\frac{C}{C_p} > \frac{V_{DD}-V_{SS}}{V_H}$, otherwise oscillation can occur on the edges of a pulse.

C_p is the external parasitic capacitance between inputs and output; the value depends on the circuit board layout.

Note

The two inputs may be connected together, but this will result in a larger through-current at the moment of switching.