

FEATURES/BENEFITS

- Enhanced N channel FET with no inherent diode to V_{CC}
- 5Ω bidirectional switches connect inputs to outputs
- Zero propagation delay, zero ground bounce
- Ultra low power with $0.2\mu A$ typical I_{CC}
- Undershoot clamp diodes on all switch and control pins
- QS3L2383 is 25Ω version for low noise
- Bus exchange allows nibble swap
- Available in SOIC, HQSOP, and QSOP

APPLICATIONS

- Hot-swapping, hot-docking (Application Note AN-13)
- Voltage translation (5V to 3.3V; Application Note AN-11)
- Resource sharing
- Crossbar switching

DESCRIPTION

The QS3L383 and QS3L2383 each provides ten high-speed CMOS TTL-compatible bus exchange switches. The low ON resistance of the QS3L383 allows inputs to be connected to outputs without adding propagation delay and without generating additional ground bounce noise. The Bus Enable (\overline{BE}) signal turns the switches on. The Bus Exchange (BX) signal provides nibble swap of the AB and CD pairs of signals. This exchange configuration allows byte swapping of buses in systems. It can also be used as a 5-wide 2-to-1 multiplexer and to create low delay barrel shifters, etc.

The QS3L2383 adds an internal 25Ω resistor to reduce reflection noise in high-speed applications. When the switch is closed, it acts as the source termination for the driver connected to it.

Figure 1. Functional Block Diagram

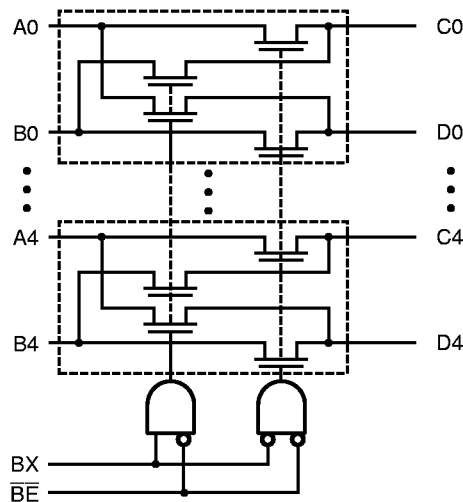

Table 1. Pin Description

Name	I/O	Function
A0-A4, B0-B4	I/O	Buses A, B
C0-C4, D0-D4	I/O	Buses C, D
\overline{BE}	I	Bus Switch Enable
BX	I	Bus Exchange

Figure 2. Pin Configuration (All Pins Top View)

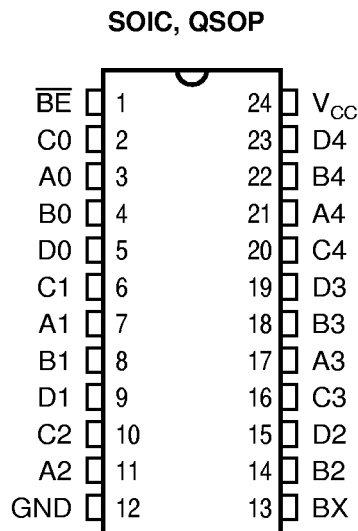

Table 2. Function Table

\overline{BE}	BX	A0-A4	B0-B4	Function
H	X	Hi-Z	Hi-Z	Disconnect
L	L	C0-C4	D0-D4	Connect
L	H	D0-D4	C0-C4	Exchange

Table 3. Absolute Maximum Ratings

Supply Voltage to Ground	-0.5V to +7.0V
DC Switch Voltage V_S	-0.5V to +7.0V
DC Input Voltage V_{IN}	-0.5V to +7.0V
AC Input Voltage (for a pulse width ≤ 20 ns)	-3.0V
DC Output Current Max. Sink Current/Pin	120mA
Maximum Power Dissipation	0.5 watts
T_{STG} Storage Temperature	-65° to +150°C

Note: ABSOLUTE MAXIMUM CONTINUOUS RATINGS are those values beyond which damage to the device may occur. Exposure to these conditions or conditions beyond those indicated may adversely affect device reliability. Functional operation under absolute-maximum conditions is not implied.

Table 4. Capacitance

$T_A = 25^\circ\text{C}$, $f = 1\text{MHz}$, $V_{IN} = 0\text{V}$, $V_{OUT} = 0\text{V}$

Pins	SOIC, QSOP		HQSOP		Unit
	Typ	Max	Typ	Max	
Control Pins	3	5	6	7	pF
QuickSwitch Channels (Switch OFF)	5	7	10	11	pF

Note: Capacitance is guaranteed, but not production tested. For total capacitance while the switch is ON, please see section 1 under "Input and Switch Capacitance."

Table 5. DC Electrical Characteristics Over Operating Range

Commercial: $T_A = -40^{\circ}\text{C}$ to 85°C , $V_{CC} = 5.0\text{V} \pm 5\%$ Military: $T_A = -55^{\circ}\text{C}$ to 125°C , $V_{CC} = 5.0\text{V} \pm 10\%$

Symbol	Parameter	Test Conditions	Min	Typ ⁽¹⁾	Max	Unit
V_{IH}	Input HIGH Voltage	Guaranteed Logic HIGH for Control Inputs	2.0	—	—	V
V_{IL}	Input LOW Voltage	Guaranteed Logic LOW for Control Inputs	—	—	0.8	V
$ I_{IN} $	Input Leakage Current (Control Inputs)	$0 \leq V_{IN} \leq V_{CC}$	—	0.01	1	μA
$ I_{OZ} $	Off-State Current (Hi-Z)	$0 \leq V_{OUT} \leq V_{CC}$, Switches OFF	—	0.01	1	μA
R_{ON}	Switch ON Resistance ⁽²⁾	$V_{CC} = \text{Min.}$, 3L383 (Com)	—	5	7	Ω
		$V_{IN} = 0.0\text{V}$, 3L383 (Mil)	—	10	12	
		$I_{ON} = 30\text{mA}$, 3L2383 (Com)	20	28	40	
		3L2383 (Mil)	20	35	45	
R_{ON}	Switch ON Resistance ⁽²⁾	$V_{CC} = \text{Min.}$, 3L383 (Com)	—	10	15	Ω
		$V_{IN} = 2.4\text{V}$, 3L383 (Mil)	—	15	20	
		$I_{ON} = 15\text{mA}$, 3L2383 (Com)	20	35	48	
		3L2383 (Mil)	20	40	55	
V_P	Pass Voltage ⁽³⁾	$V_{IN} = V_{CC} = 5\text{V}$, $I_{OUT} = -5\mu\text{A}$	3.7	4	4.2	V

3

Notes:

1. Typical values indicate $V_{CC} = 5.0\text{V}$ and $T_A = 25^{\circ}\text{C}$.
2. For a diagram explaining the procedure for R_{ON} measurement, please see Section 1 under “DC Electrical Characteristics.” Max. value of R_{ON} guaranteed, but not production tested.
3. Pass Voltage is guaranteed, but not production tested.

Figure 3. Typical ON Resistance vs V_{IN} at $V_{CC} = 5.0\text{V}$ (QS3L383)

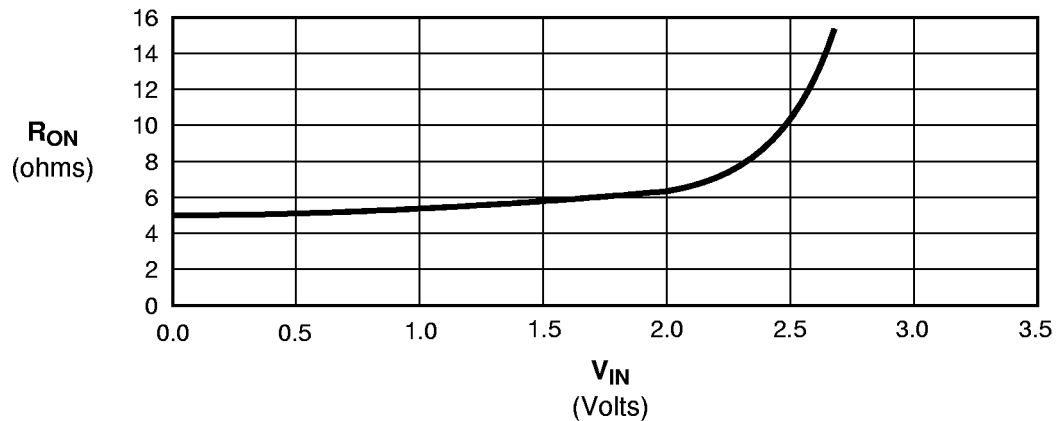

Note: For QS3L2383, add 23Ω to R_{ON} shown.

Table 6. Power Supply Characteristics Over Operating Range

Commercial: $T_A = -40^{\circ}\text{C}$ to 85°C , $V_{CC} = 5.0\text{V} \pm 5\%$ Military: $T_A = -55^{\circ}\text{C}$ to 125°C , $V_{CC} = 5.0\text{V} \pm 10\%$

Symbol	Parameter	Test Conditions ⁽¹⁾	Typ	Max	Unit
I_{CCQ}	Quiescent Power Supply Current	$V_{CC} = \text{Max.}, V_{IN} = \text{GND or } V_{CC}, f = 0$	0.2	3.0	μA
ΔI_{CC}	Power Supply Current per Input HIGH ⁽²⁾	$V_{CC} = \text{Max.}, V_{IN} = 3.4\text{V}, f = 0$ per Control Input	—	1.5	mA
Q_{CCD}	Dynamic Power Supply Current per MHz ⁽³⁾	$V_{CC} = \text{Max.}, \text{ABCD Pins Open, Control Input Toggling @ } 50\% \text{ Duty Cycle}$	—	0.25	mA/MHz

Notes:

1. For conditions shown as Min. or Max., use the appropriate values specified under DC specifications.
2. Per TTL driven input ($V_{IN} = 3.4\text{V}$, control inputs only). A, B, C, D pins do not contribute to ΔI_{CC} .
3. This current applies to the control inputs only and represents the current required to switch internal capacitance at the specified frequency. The A, B, C, D inputs generate no significant AC or DC currents as they transition. This parameter is guaranteed, but not production tested.

Table 7. Switching Characteristics Over Operating Range

Commercial: $T_A = -40^{\circ}\text{C}$ to 85°C , $V_{CC} = 5.0\text{V} \pm 5\%$ Military: $T_A = -55^{\circ}\text{C}$ to 125°C , $V_{CC} = 5.0\text{V} \pm 10\%$
 $C_{LOAD} = 50\text{pF}$, $R_{LOAD} = 500\Omega$ unless otherwise noted.

Symbol	Description ⁽¹⁾		QS3L383			QS3L2383			Unit
			Min	Typ	Max	Min	Typ	Max	
t_{PLH}	Data Propagation Delay ^(2,3)	COM	—	—	0.25 ⁽³⁾	—	—	1.25 ⁽³⁾	ns
t_{PHL}	AiBi to CiDi, CiDi to AiBi	MIL	—	—	0.75	—	—	1.75	ns
t_{PZL}	Switch Turn-on Delay	COM	1.5	—	6.5	1.5	—	7.5	ns
t_{PZH}	$\overline{\text{BE}}$ to Ai, Bi, Ci, Di	MIL	1.5	—	7.5	1.5	—	8.5	ns
t_{PLZ}	Switch Turn-off Delay ⁽²⁾	COM	1.5	—	5.5	1.5	—	6.5	ns
t_{PHZ}	$\overline{\text{BE}}$ to Ai, Bi, Ci, Di	MIL	1.5	—	6.5	1.5	—	7.5	ns
t_{BX}	Switch Multiplex Delay	COM	1.5	—	6.5	1.5	—	7.5	ns
	BX to Ai, Bi, Ci, Di	MIL	1.5	—	7.5	1.5	—	8.5	ns

Notes:

1. See Test Circuit and Waveforms. Minimums guaranteed, but not production tested.
2. This parameter is guaranteed, but not production tested.
3. The time constant for the switch alone is of the order of 0.25ns for 3L383, and 1.25 ns for 3L2383 at $C_L = 50\text{pF}$. The bus switch contributes no propagation delay other than the RC delay of the ON resistance of the switch and the load capacitance. Since this time constant is much smaller than the rise/fall times of typical driving signals, it adds very little propagation delay to the system. Propagation delay of the bus switch when used in a system is determined by the driving circuit on the driving side of the switch and its interaction with the load on the driven side.

300-MIL SOIC - Package Code SO
Plastic Small Outline Gull-Wing

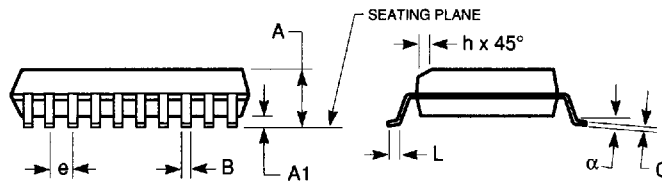
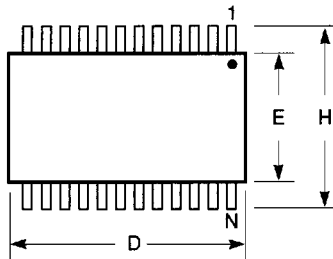

Notes:

1. Refer to applicable symbol list.
2. All dimensions are in inches.
3. N is the number of lead positions.
4. Dimensions D and E are to be measured at maximum material condition but do not include mold flash. Allowable mold flash is 0.006in. per side.
5. Lead coplanarity is 0.004in. maximum.

JEDEC#	MS-013AA		MS-013AC		MS-013AD		MS-013AE	
DWG#	PS16A		PS20A		PS24A		PS28A	
Symbol	Min	Max	Min	Max	Min	Max	Min	Max
A	0.096	0.104	0.096	0.104	0.096	0.104	0.096	0.104
A1	0.005	0.011	0.005	0.011	0.005	0.011	0.005	0.011
B	0.014	0.019	0.014	0.019	0.014	0.019	0.014	0.019
C	0.009	0.012	0.009	0.012	0.009	0.012	0.009	0.012
D	0.402	0.412	0.500	0.510	0.602	0.612	0.701	0.711
E	0.292	0.299	0.292	0.299	0.292	0.299	0.292	0.299
e	0.044	0.056	0.044	0.056	0.044	0.056	0.044	0.056
H	0.396	0.416	0.396	0.416	0.396	0.416	0.396	0.416
h	0.010	0.016	0.010	0.016	0.010	0.016	0.010	0.016
L	0.020	0.040	0.020	0.040	0.020	0.040	0.020	0.040
N	16		20		24		28	
α	0°	8°	0°	8°	0°	8°	0°	8°

7466803 0003749 900

QUALITY SEMICONDUCTOR, INC.

150-MIL QSOP - Package Code Q

**Quarter-Size Outline Package
Plastic Small Outline Gull-Wing**

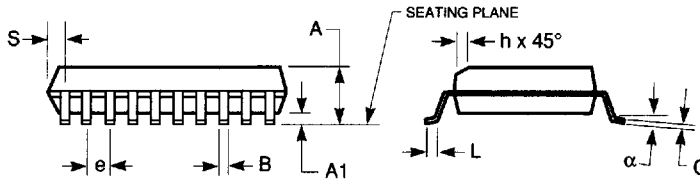
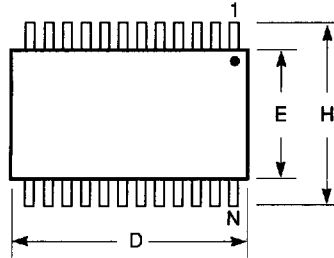

Notes:

1. Refer to applicable symbol list.
2. All dimensions are in inches.
3. N is the number of lead positions.
4. Dimensions D and E are to be measured at maximum material condition but do not include mold flash. Allowable mold flash is 0.006in. per side.
5. Lead coplanarity is 0.004in. maximum.

JEDEC#	MO-137AB			MO-137AD			MO-137AE			MO-137AF		
DWG#	PSS-16A			PSS-20A			PSS-24A			PSS-28A		
Symbol	Min	Nom	Max	Min	Nom	Max	Min	Nom	Max	Min	Nom	Max
A	0.060	0.064	0.068	0.060	0.064	0.068	0.060	0.064	0.068	0.060	0.064	0.068
A1	0.004	0.006	0.008	0.004	0.006	0.008	0.004	0.006	0.008	0.004	0.006	0.008
B	0.009	0.010	0.012	0.009	0.010	0.012	0.009	0.010	0.012	0.009	0.010	0.012
C	0.007	0.008	0.010	0.007	0.008	0.010	0.007	0.008	0.010	0.007	0.008	0.010
D	0.189	0.193	0.197	0.337	0.341	0.344	0.337	0.341	0.344	0.386	0.390	0.394
E	0.150	0.154	0.157	0.150	0.154	0.157	0.150	0.154	0.157	0.150	0.154	0.157
e	0.025 BSC			0.025 BSC			0.025 BSC			0.025 BSC		
H	0.230	0.236	0.244	0.230	0.236	0.244	0.230	0.236	0.244	0.230	0.236	0.244
h	0.010	0.013	0.016	0.010	0.013	0.016	0.010	0.013	0.016	0.010	0.013	0.016
L	0.016	0.025	0.035	0.016	0.025	0.035	0.016	0.025	0.035	0.016	0.025	0.035
N	16			20			24			28		
alpha	0°	5°	8°	0°	5°	8°	0°	5°	8°	0°	5°	8°
S	0.006	0.009	0.010	0.056	0.058	0.060	0.031	0.033	0.035	0.031	0.033	0.035