

**KK74LS05**

**Hex Inverters with Open-Drain Outputs**

This device contains independent inverters. It performs the Boolean function  $Y = \overline{A}$ . The open collector outputs require pull-up resistor to perform correctly. Open-collector devices are often used to generate higher  $V_{OH}$  levels.

**Pull-Up Resistor Equations**

$$R_{MAX} = \frac{V_{CC}(Min) - V_{OH}}{N_1(I_{OH}) + N_2(I_{IH})}$$

$$R_{MIN} = \frac{V_{CC}(Max) - V_{OL}}{I_{OL} + N_3(I_{IL})}$$

Where:  $N_1(I_{OH})$ =total maximum output high current for all outputs tied to pull-up resistor  
 $N_2(I_{IH})$ =total input high current for all inputs tied to pull-up resistor  
 $N_3(I_{IL})$ =total input low current for all inputs tied to pull-up resistor

**LOGIC DIAGRAM**

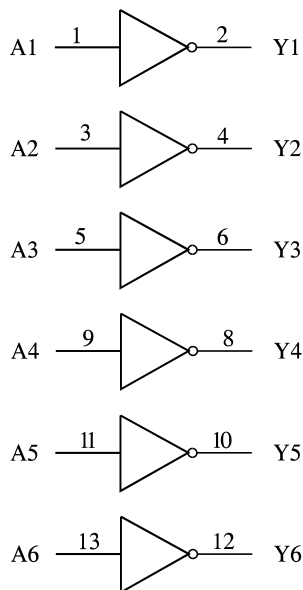

PIN 14 =  $V_{CC}$   
 PIN 7 = GND

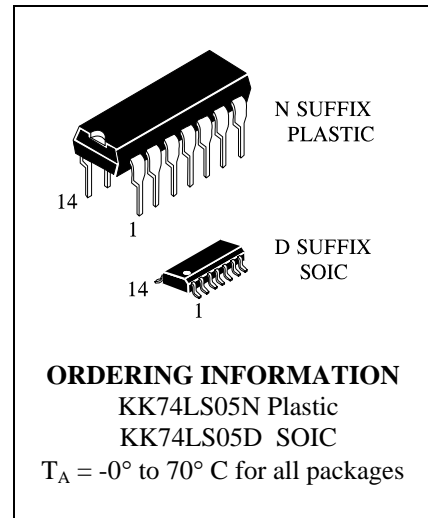

**PIN ASSIGNMENT**

A1	1 ●	14	$V_{CC}$
Y1	2	13	A6
A2	3	12	Y6
Y2	4	11	A5
A3	5	10	Y5
Y3	6	9	A4
GND	7	8	Y4

**FUNCTION TABLE**

Inputs	Output
A	Y
L	H
H	L

**MAXIMUM RATINGS\***

Symbol	Parameter	Value	Unit
V <sub>CC</sub>	Supply Voltage	7.0	V
V <sub>IN</sub>	Input Voltage	7.0	V
V <sub>OUT</sub>	Output Voltage	7.0	V
T <sub>stg</sub>	Storage Temperature Range	-65 to +150	°C

\*Maximum Ratings are those values beyond which damage to the device may occur. Functional operation should be restricted to the Recommended Operating Conditions.

**RECOMMENDED OPERATING CONDITIONS**

Symbol	Parameter	Min	Max	Unit
V <sub>CC</sub>	Supply Voltage	4.75	5.25	V
V <sub>IH</sub>	High Level Input Voltage	2.0		V
V <sub>IL</sub>	Low Level Input Voltage		0.8	V
V <sub>OH</sub>	High Level Output Voltage		5.5	V
I <sub>OL</sub>	Low Level Output Current		8.0	mA
T <sub>A</sub>	Ambient Temperature Range	0	+70	°C

**DC ELECTRICAL CHARACTERISTICS** over full operating conditions

Symbol	Parameter	Test Conditions	Guaranteed Limit		Unit	
			Min	Max		
V <sub>IK</sub>	Input Clamp Voltage	V <sub>CC</sub> = min, I <sub>IN</sub> = -18 mA		-1.5	V	
I <sub>OH</sub>	High Level Output Current	V <sub>CC</sub> = min, V <sub>OH</sub> = max		0.1	mA	
V <sub>OL</sub>	Low Level Output Voltage	V <sub>CC</sub> = min, I <sub>OL</sub> = 4 mA		0.4	V	
		V <sub>CC</sub> = min, I <sub>OL</sub> = 8 mA		0.5		
I <sub>IH</sub>	High Level Input Current	V <sub>CC</sub> = max, V <sub>IN</sub> = 2.7 V		20	μA	
		V <sub>CC</sub> = max, V <sub>IN</sub> = 7.0 V		0.1	mA	
I <sub>IL</sub>	Low Level Input Current	V <sub>CC</sub> = max, V <sub>IN</sub> = 0.4 V		-0.4	mA	
I <sub>CC</sub>	Supply Current	V <sub>CC</sub> = max	Total with outputs high		2.4	mA
			Total with outputs low		6.6	

**AC ELECTRICAL CHARACTERISTICS** ( $V_{CC} = 5.0\text{ V}$ ,  $C_L = 15\text{ pF}$ ,  $T_A = 25^\circ\text{C}$ ,  $R_L = 2\text{ k}\Omega$ ,  $t_r = 15\text{ ns}$ ,  $t_f = 6.0\text{ ns}$ )

Symbol	Parameter	Min	Max	Unit
$t_{PLH}$	Propagation Delay Time		32	ns
$t_{PHL}$	Propagation Delay Time		28	ns

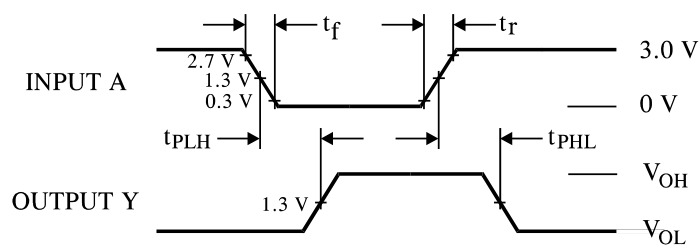

**Figure 1. Switching Waveforms**

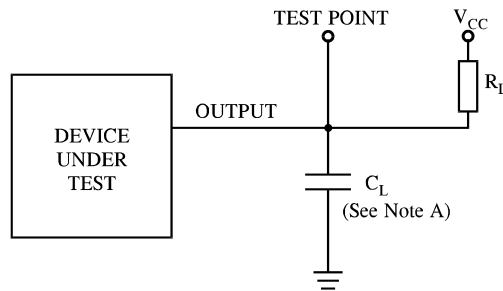

NOTE A.  $C_L$  includes probe and jig capacitance.

**Figure 2. Test Circuit**

**N SUFFIX PLASTIC DIP  
(MS - 001AA)**

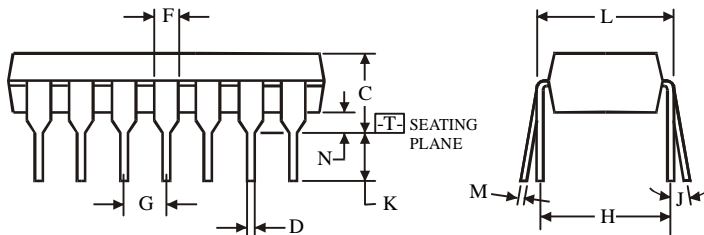
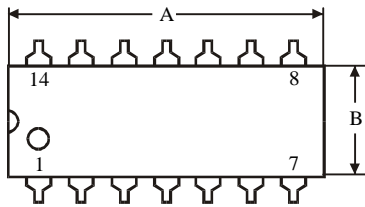
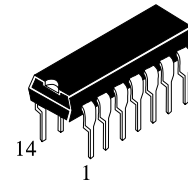

$\oplus 0.25 (0.010) \text{ (M) T}$

**NOTES:**

- Dimensions "A", "B" do not include mold flash or protrusions.  
Maximum mold flash or protrusions 0.25 mm (0.010) per side.

Symbol	Dimension, mm	
	MIN	MAX
A	18.67	19.69
B	6.1	7.11
C		5.33
D	0.36	0.56
F	1.14	1.78
G	2.54	
H	7.62	
J	0°	10°
K	2.92	3.81
L	7.62	8.26
M	0.2	0.36
N	0.38	

**D SUFFIX SOIC  
(MS - 012AB)**

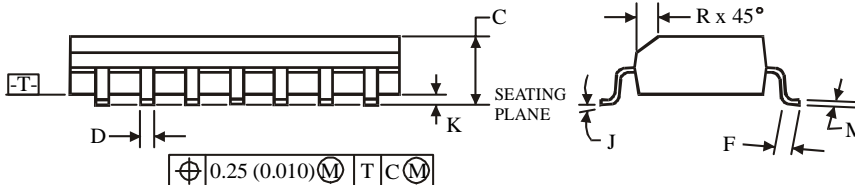
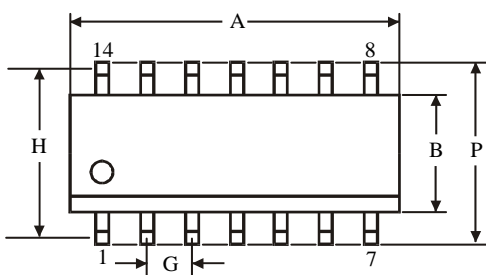
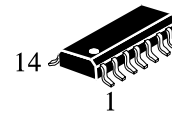

$\oplus 0.25 (0.010) \text{ (M) T C (M)}$

**NOTES:**

- Dimensions A and B do not include mold flash or protrusion.
- Maximum mold flash or protrusion 0.15 mm (0.006) per side for A; for B - 0.25 mm (0.010) per side.

Symbol	Dimension, mm	
	MIN	MAX
A	8.55	8.75
B	3.8	4
C	1.35	1.75
D	0.33	0.51
F	0.4	1.27
G	1.27	
H	5.27	
J	0°	8°
K	0.1	0.25
M	0.19	0.25
P	5.8	6.2
R	0.25	0.5