

PRELIMINARY DATA SHEET

GD74F08 QUAD 2-INPUT AND GATE

Description

This device contains four independent 2-input AND gates, each of which performs the Boolean functions $Y = A \cdot B$ or $Y = \bar{A} + \bar{B}$.

Function Table (each gate)

Inputs		Outputs
A	B	Y
H	H	H
L	X	L
X	L	L

X Immaterial

Pin Configuration

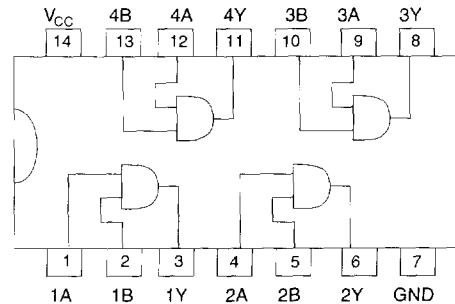

Package Type: 14 DIP, 14 SOP Available

Waveform Of Functions

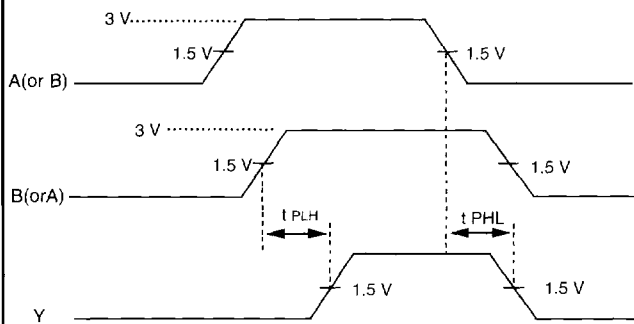

AC Test Circuit

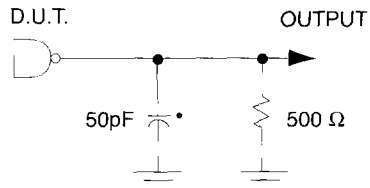

* Includes jig and probe capacitance

Input Condition

Frequency : 1.0 MHz
 Duty Cycle : 50%
 Rising Time : 2.5 ns
 Falling Time : 2.5 ns
 Amplitude : 0 to 3V

Absolute Maximum Ratings

- Storage Temperature -65°C to 150°C
- Ambient Temperature Under Bias -55°C to 125°C
- Junction Temperature Under Bias -0.5°C to 175°C
- V_{CC} Voltage -0.5 V to 7.0 V
- Input Voltage -5.0 V to 7.0 V
- Input Current -30 mA to 5.0 mA
- Output Voltage -0.5 V to 5.5 V

Note: Absolute Maximum ratings are values beyond which the device may be damaged or have its useful life impaired. Functional operation under these conditions is not implied.

Recommended Operating Conditions

SYMBOL	PARAMETER	MIN	MAX	UNIT
T_A	Free Air Ambient Temperature	0	70	°C
V_{CC}	Supply Voltage	4.5	5.5	V

AC Characteristics

SYMBOL	PARAMETER	TEST CONDITION						UNIT
		$T_A = 25^\circ\text{C}$			$T_A = 0 \sim 70^\circ\text{C}$			
		Min	Typ	Max	Min	Typ	Max	
t_{PLH}	Propagation	3.0	4.2	5.6	3.0	-	6.6	ns
t_{PHL}	Delay	2.5	4.0	5.3	2.5	-	6.3	ns

DC Electrical Characteristics over recommended operating free-air temperature range

SYMBOL	PARAMETER	TEST CONDITIONS	Min	Typ	Max	UNIT	V_{CC}	CIRCUIT
V_{IH}	Input High Voltage	-----	2.0			V		
V_{IL}	Input Low Voltage	-----			0.8	V		
V_{CD}	Input Clamp Diode Voltage	$I_{IN} = -18\text{mA}$			-1.2	V	Min	See FIG. 1
V_{OH}	Output High Voltage	$I_{OH} = -1\text{mA}$ $I_{OH} = -1\text{mA}$	2.5 2.7			V	4.5 4.75	See FIG. 2
V_{OL}	Output Low Voltage	$I_{OL} = 20\text{mA}$			0.5	V	Min	
I_I	Input High Current Breakdown Test	$V_{IN} = 7.0\text{V}$			7.0	μA	Max	See FIG. 3
I_{IH}	Input High Current	$V_{IN} = 2.7\text{V}$			5.0	μA	Max	
I_{IL}	Input Low Current	$V_{IN} = 0.5\text{V}$			-0.6	mA	Max	
I_{ILK}	Input Leakage Circuit Current	$V_{IN} = 4.75\text{V}$ All other pins grounded			1.9	μA	0.0	See FIG. 4
I_{OLK}	Output Leakage Circuit Current	$V_{OUT} = 150\text{mV}$ All other pins grounded			3.75	μA	0.0	
I_{OS}	Output Short Circuit Current	$V_{OUT} = 0\text{V}$	-60		-150	mA	Max	See FIG. 5
I_{CCH} I_{CCL}	Supply Current	$V_{OUT} = \text{High}$ $V_{OUT} = \text{Low}$		5.5 8.6	8.3 12.9	mA	Max	See FIG. 6

* For I_{OS} . Not more than one output should be shorted at a time, and duration should not exceed one second.

DC Test Circuit

FIG. 1 V_{CD} Test
(force I_{IN} and measure V_{CD})

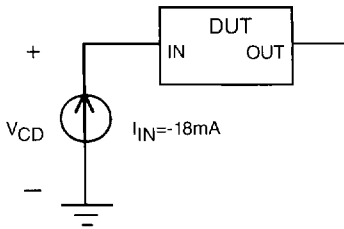

FIG. 2 V_{OH} & V_{OL} Test
(force I_O and measure V_{OH} or V_{OL})

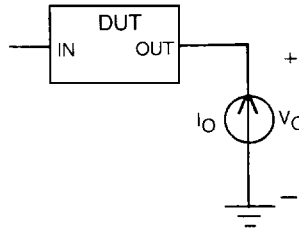

FIG. 3 I_I , I_{IH} & I_{IL} Test
(force V_{IN} and measure I_I , I_{IH} or I_{IL})

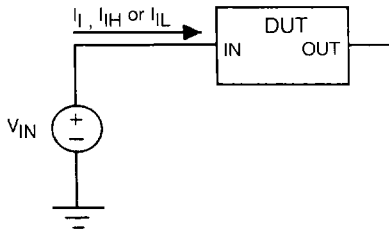

FIG. 5 I_{OS} Test

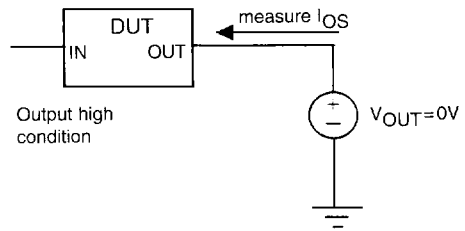

FIG. 4 I_{ILK} Test & I_{OLK} Test

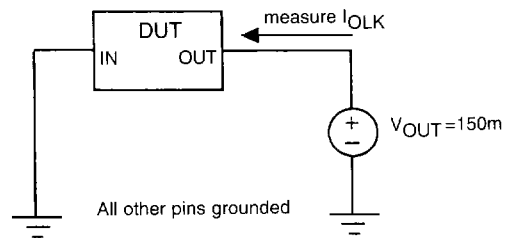
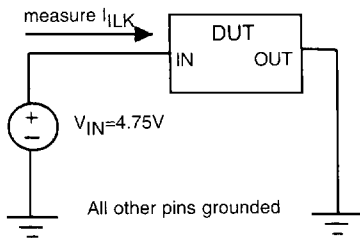

FIG. 6 I_{CCH} Test & I_{CCL} Test

