

## DM54LS107A/DM74LS107A Dual Negative-Edge-Triggered Master-Slave J-K Flip-Flops with Clear and Complementary Outputs

### General Description

This device contains two independent negative-edge-triggered J-K flip-flops with complementary outputs. The J and K data is processed by the flip-flops on the falling edge of the clock pulse. The clock triggering occurs at a voltage level and is not directly related to the transition time of the negative going edge of the clock pulse. The data on the J

and K inputs may change while the clock is high or low without affecting the outputs as long as setup and hold times are not violated. A low logic level on the clear input will reset the outputs regardless of the logic levels of the other inputs.

### Connection Diagram

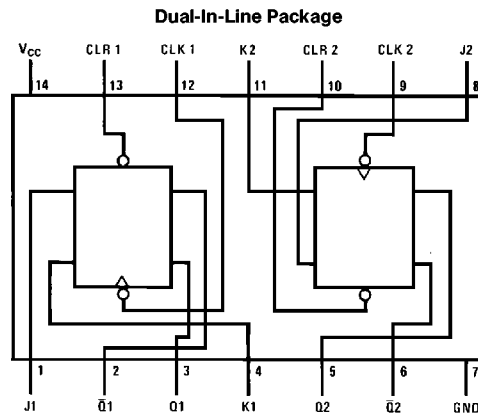

TL/F/6367-1

Order Number DM54LS107AJ, DM54LS107AW, DM74LS107AM or DM74LS107AN  
See NS Package Number J14A, M14A, N14A or W14B

### Function Table

Inputs				Outputs	
CLR	CLK	J	K	Q	$\bar{Q}$
L	X	X	X	L	H
H	↓	L	L	$Q_0$	$\bar{Q}_0$
H	↓	H	L	H	L
H	↓	L	H	L	H
H	↓	H	H	Toggle	
H	H	X	X	$Q_0$	$\bar{Q}_0$

H = High Logic Level

X = Either Low or High Logic Level

L = Low Logic Level

↓ = Negative going edge of pulse.

$Q_0$  = The output logic level before the indicated input conditions were established.

Toggle = Each output changes to the complement of its previous level on each falling edge of the clock pulse.

DM54LS107A/DM74LS107A Dual Negative-Edge-Triggered Master-Slave J-K Flip-Flops with Clear and Complementary Outputs

## Absolute Maximum Ratings (Note)

If Military/Aerospace specified devices are required, please contact the National Semiconductor Sales Office/Distributors for availability and specifications.

Supply Voltage	7V
Input Voltage	7V
Operating Free Air Temperature Range	
DM54LS	-55°C to +125°C
DM74LS	0°C to +70°C
Storage Temperature Range	-65°C to +150°C

Note: The "Absolute Maximum Ratings" are those values beyond which the safety of the device cannot be guaranteed. The device should not be operated at these limits. The parametric values defined in the "Electrical Characteristics" table are not guaranteed at the absolute maximum ratings. The "Recommended Operating Conditions" table will define the conditions for actual device operation.

## Recommended Operating Conditions

Symbol	Parameter	DM54LS107A			DM74LS107A			Units
		Min	Nom	Max	Min	Nom	Max	
V <sub>CC</sub>	Supply Voltage	4.5	5	5.5	4.75	5	5.25	V
V <sub>IH</sub>	High Level Input Voltage	2			2			V
V <sub>IL</sub>	Low Level Input Voltage			0.7			0.8	V
I <sub>OH</sub>	High Level Output Current			-0.4			-0.4	mA
I <sub>OL</sub>	Low Level Output Current			4			8	mA
f <sub>CLK</sub>	Clock Frequency (Note 2)	0		30	0		30	MHz
f <sub>CLK</sub>	Clock Frequency (Note 3)	0		25	0		25	MHz
t <sub>w</sub>	Pulse Width (Note 2)	Clock High	20		20			ns
		Clear Low	25		25			
t <sub>w</sub>	Pulse Width (Note 3)	Clock High	25		25			ns
		Clear Low	30		30			
t <sub>SU</sub>	Setup Time (Notes 1 & 2)	20 ↓			20 ↓			ns
t <sub>SU</sub>	Setup Time (Notes 1 & 3)	25 ↓			25 ↓			ns
t <sub>H</sub>	Hold Time (Notes 1 & 2)	0 ↓			0 ↓			ns
t <sub>H</sub>	Hold Time (Notes 1 & 3)	5 ↓			5 ↓			ns
T <sub>A</sub>	Free Air Operating Temperature	-55		125	0		70	°C

Note 1: The symbol (↓) indicates the falling edge of the clock pulse is used for reference.

Note 2: C<sub>L</sub> = 15 pF, R<sub>L</sub> = 2 kΩ, T<sub>A</sub> = 25°C and V<sub>CC</sub> = 5V.

Note 3: C<sub>L</sub> = 50 pF, R<sub>L</sub> = 2 kΩ, T<sub>A</sub> = 25°C and V<sub>CC</sub> = 5V.

## Electrical Characteristics over recommended operating free air temperature range (unless otherwise noted)

Symbol	Parameter	Conditions	Min	Typ (Note 1)	Max	Units
V <sub>I</sub>	Input Clamp Voltage	V <sub>CC</sub> = Min, I <sub>I</sub> = -18 mA			-1.5	V
V <sub>OH</sub>	High Level Output Voltage	V <sub>CC</sub> = Min, I <sub>OH</sub> = Max V <sub>IL</sub> = Max, V <sub>IH</sub> = Min	DM54	2.5	3.4	V
			DM74	2.7	3.4	
V <sub>OL</sub>	Low Level Output Voltage	V <sub>CC</sub> = Min, I <sub>OL</sub> = Max V <sub>IL</sub> = Max, V <sub>IH</sub> = Min	DM54		0.25	V
			DM74		0.35	
		I <sub>OL</sub> = 4mA, V <sub>CC</sub> = Min	DM74		0.25	
I <sub>I</sub>	Input Current @ Max Input Voltage	V <sub>CC</sub> = Max, V <sub>I</sub> = 7V	J, K		0.1	mA
			Clear		0.3	
			Clock		0.4	

## Electrical Characteristics

over recommended operating free air temperature range (unless otherwise noted) (Continued)

Symbol	Parameter	Conditions	Min	Typ (Note 1)	Max	Units
$I_{IH}$	High Level Input Current	$V_{CC} = \text{Max}$ $V_I = 2.7V$	J, K		20	$\mu A$
			Clear		60	
			Clock		80	
$I_{IL}$	Low Level Input Current	$V_{CC} = \text{Max}$ $V_I = 0.4V$	J, K		-0.4	mA
			Clear		-0.8	
			Clock		-0.8	
$I_{OS}$	Short Circuit Output Current	$V_{CC} = \text{Max}$ (Note 2)	DM54	-20	-100	mA
			DM74	-20	-100	
$I_{CC}$	Supply Current	$V_{CC} = \text{Max}$ (Note 3)		4	6	mA

## Switching Characteristics at $V_{CC} = 5V$ and $T_A = 25^\circ C$ (See Section 1 for Test Waveforms and Output Load)

Symbol	Parameter	From (Input) To (Output)	$R_L = 2 k\Omega$				Units
			$C_L = 15 pF$		$C_L = 50 pF$		
			Min	Max	Min	Max	
$f_{MAX}$	Maximum Clock Frequency		30		25		MHz
$t_{PLH}$	Propagation Delay Time Low to High Level Output	Preset to Q		20		24	ns
$t_{PHL}$	Propagation Delay Time High to Low Level Output	Preset to $\bar{Q}$		20		28	ns
$t_{PLH}$	Propagation Delay Time Low to High Level Output	Clear to $\bar{Q}$		20		24	ns
$t_{PHL}$	Propagation Delay Time High to Low Level Output	Clear to Q		20		28	ns
$t_{PLH}$	Propagation Delay Time Low to High Level Output	Clock to Q or $\bar{Q}$		20		24	ns
$t_{PHL}$	Propagation Delay Time High to Low Level Output	Clock to Q or $\bar{Q}$		20		28	ns

**Note 1:** All typicals are at  $V_{CC} = 5V$ ,  $T_A = 25^\circ C$ .

**Note 2:** Not more than one output should be shorted at a time, and the duration should not exceed one second. For devices, with feedback from the outputs, where shorting the outputs to ground may cause the outputs to change logic state an equivalent test may be performed where  $V_O = 2.25V$  and  $2.125V$  for DM54 and DM74 series, respectively, with the minimum and maximum limits reduced by one half from their stated values. This is very useful when using automatic test equipment.

**Note 3:** With all inputs open,  $I_{CC}$  is measured with the Q and  $\bar{Q}$  outputs high in turn. At the time of measurement the clock is grounded.

**Physical Dimensions** inches (millimeters)

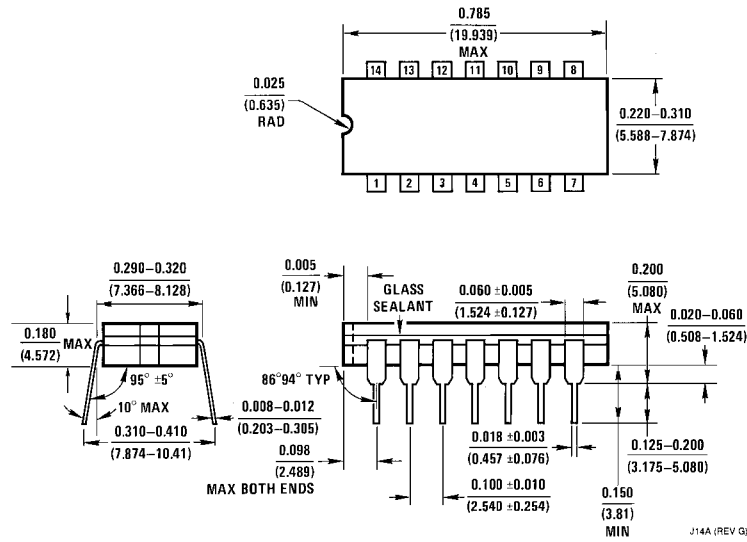

**14-Lead Ceramic Dual-In-Line Package (J)**  
**Order Number DM54LS107AJ**  
**NS Package Number J14A**

J14A (REV. G)

**Physical Dimensions** inches (millimeters) (Continued)

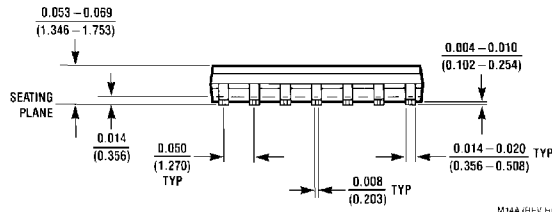
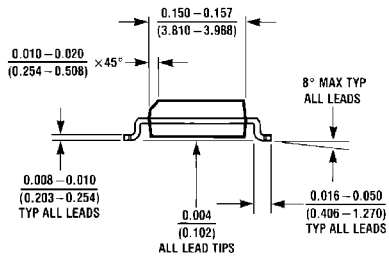
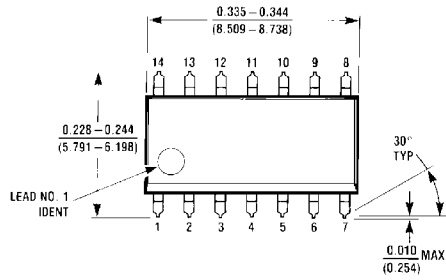

**14-Lead Small Outline Molded Package (M)**  
**Order Number DM74LS107AM**  
**NS Package Number M14A**

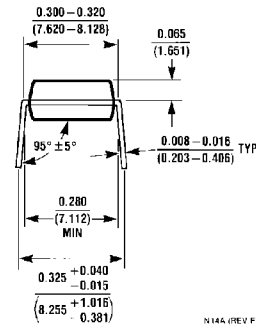
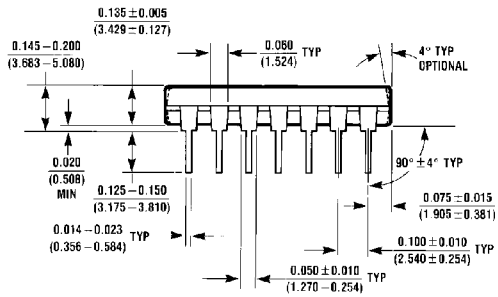
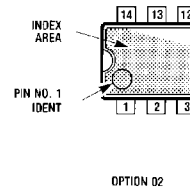
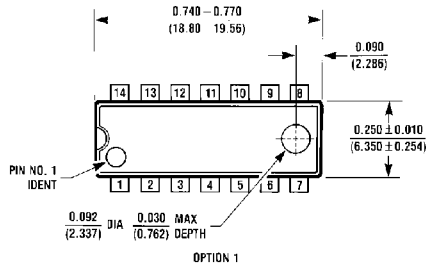

**14-Lead Molded Dual-In-Line Package (N)**  
**Order Number DM74LS107AN**  
**NS Package Number N14A**

**DM54LS107A/DM74LS107A Dual Negative-Edge-Triggered Master-Slave  
J-K Flip-Flops with Clear and Complementary Outputs**

**Physical Dimensions** inches (millimeters) (Continued)

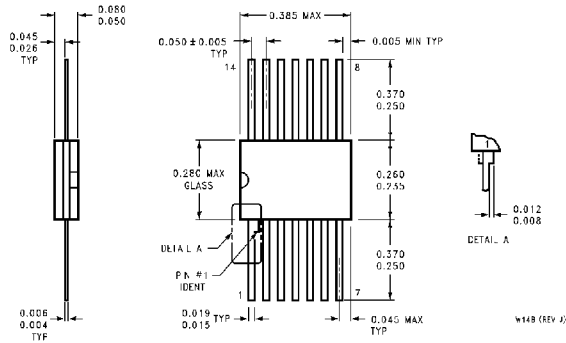

**14-Lead Ceramic Flat Package (W)  
Order Number DM54LS107AW  
NS Package Number W14B**

**LIFE SUPPORT POLICY**

NATIONAL'S PRODUCTS ARE NOT AUTHORIZED FOR USE AS CRITICAL COMPONENTS IN LIFE SUPPORT DEVICES OR SYSTEMS WITHOUT THE EXPRESS WRITTEN APPROVAL OF THE PRESIDENT OF NATIONAL SEMICONDUCTOR CORPORATION. As used herein:

1. Life support devices or systems are devices or systems which, (a) are intended for surgical implant into the body, or (b) support or sustain life, and whose failure to perform, when properly used in accordance with instructions for use provided in the labeling, can be reasonably expected to result in a significant injury to the user.
2. A critical component is any component of a life support device or system whose failure to perform can be reasonably expected to cause the failure of the life support device or system, or to affect its safety or effectiveness.



**National Semiconductor Corporation**  
1111 West Bardin Road  
Arlington, TX 76017  
Tel: 1(800) 272-9959  
Fax: 1(800) 737-7018

**National Semiconductor Europe**  
Fax: (+49) 0-180-530 85 86  
Email: onjwge@tevm2.nsc.com  
Deutsch Tel: (+49) 0-180-530 85 85  
English Tel: (+49) 0-180-532 78 32  
Français Tel: (+49) 0-180-532 93 58  
Italiano Tel: (+49) 0-180-534 16 80

**National Semiconductor Hong Kong Ltd.**  
13th Floor, Straight Block,  
Ocean Centre, 5 Canton Rd.  
Tsimshatsui, Kowloon  
Hong Kong  
Tel: (852) 2737-1600  
Fax: (852) 2736-9960

**National Semiconductor Japan Ltd.**  
Tel: 81-043-299-2309  
Fax: 81-043-299-2408

National does not assume any responsibility for use of any circuitry described, no circuit patent licenses are implied and National reserves the right at any time without notice to change said circuitry and specifications.