

CA158, CA158A, CA258, CA258A, CA358, CA358A, CA2904, LM358*, LM2904* 032511

Dual Operational Amplifiers

For Commercial, Industrial, and Military Applications

Features:

- Internal frequency compensation for unity gain
- High dc voltage gain - 100 dB typ.
- Wide bandwidth at unity gain - 1 MHz typ.
- Wide power supply range:
Single supply 3 to 30 V
Dual supplies ± 1.5 to ± 15 V
- Low supply current - 1.5 mA typ.
- Low input bias current
- Low input offset voltage and current
- Input common-mode voltage range includes ground
- Differential input voltage range equal to $V+$ range
- Large output voltage swing - 0 to $V+ - 1.5$ V

The RCA-CA158, CA158A, CA258, CA258A, CA358, CA358A and CA2904 types consist of two independent, high gain, internally frequency compensated operational amplifiers which are designed specifically to operate from a single power supply over a wide range of voltages. They may also be operated from split power supplies. The supply current is basically independent of the supply voltage over the recommended voltage range.

These devices are particularly useful in interface circuits with digital systems and can be operated from the single common 5 Vdc power supply. They are also intended for transducer amplifiers, dc gain blocks and many other

conventional op amp circuits which can benefit from the single power supply capability.

The CA158, CA158A, CA258, CA258A, CA358, CA358A, and CA2904 types are supplied in 8-lead dual-in-line plastic packages (MINI-DIP, E suffix), 8-lead TO-5 style packages with standard leads (T suffix), and with dual-in-line formed leads (DIL-CAN, S suffix). The CA358 is also supplied in chip form (H suffix).

The CA158, CA158A, CA258, CA258A, CA358, CA358A, and CA2904 types are an equivalent to or a replacement for the industry types 158, 158A, 258, 258A, 358, 358A, and CA2904.

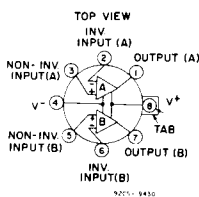

Fig. 1 - Functional diagram for CA158, CA258, and CA358 S- and T-suffix types.

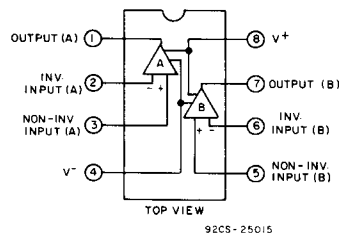

Fig. 2 - Functional diagram for CA158, CA258, CA358, and CA2904 E-suffix types.

*Technical Data on LM Branded types is identical to the corresponding CA Branded types.

CA158, CA158A, CA258, CA258A, CA358, CA358A, CA2904, LM358, LM2904

MAXIMUM RATINGS, Absolute-Maximum Values at $T_A = 25^\circ\text{C}$

SUPPLY VOLTAGE, V^+ :	
CA2904	26 V or ± 13 V
Other Types	32 V or ± 16 V
DIFFERENTIAL INPUT VOLTAGE:	
All Types	± 32 V
INPUT VOLTAGE	-0.3 V to V^+ V
INPUT CURRENT ($V_I < -0.3$ V) [†]	50 mA
OUTPUT SHORT CIRCUIT TO GROUND ($V^+ \leq 15$ V) *	Continuous
DEVICE DISSIPATION:	
Up to $T_A = 55^\circ\text{C}$	630 mW
Above $T_A = 55^\circ\text{C}$	derate linearly at 6.67 mW/ $^\circ\text{C}$
AMBIENT TEMPERATURE RANGE:	
Operating	-55 to $+125^\circ\text{C}$
Storage	-65 to $+150^\circ\text{C}$
LEAD TEMPERATURE (During Soldering):	
At distance $1/16 \pm 1/32$ in. (1.59 ± 0.79 mm) from case for 10 seconds max.	$+300^\circ\text{C}$

[†] This input current will only exist when the voltage at any of the input leads is driven negative. This current is due to the collector-base junction of the input p-n-p transistors becoming forward biased and thereby acting as input diode clamps. In addition to this diode action, there is also lateral n-p-n parasitic transistor action on the IC chip. This transistor action can cause the output voltages of the amplifiers to go to the V^+ voltage level (or to ground for a large overdrive) for the time duration that an input is driven negative. This transistor action is not destructive and normal output states will re-establish when the input voltage, which was negative, again returns to a value greater than -0.3 V dc.

* The maximum output current is approximately 40 mA independent of the magnitude of V^+ . Continuous short circuits at $V^+ > 15$ V can cause excessive power dissipation and eventual destruction. Short circuits from the output to V^+ can cause overheating and eventual destruction of the device. Destructive dissipation can result from simultaneous short circuits on both amplifiers.

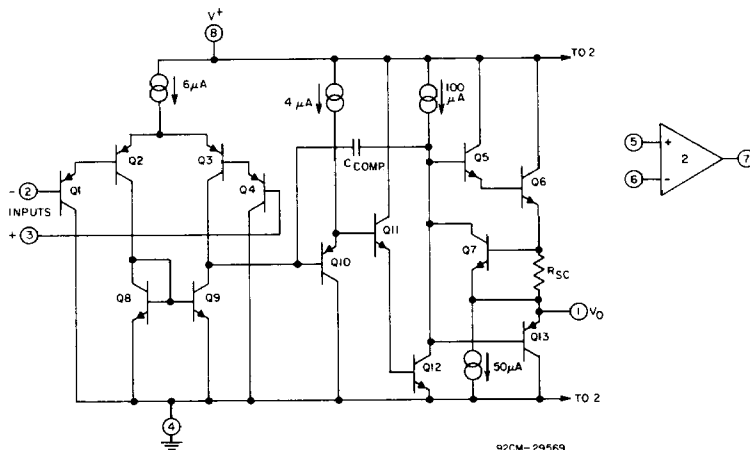

Fig. 3 — Schematic diagram — one of two operational amplifiers.

CA158, CA158A, CA258, CA258A, CA358, CA358A, CA2904, LM358, LM2904

ELECTRICAL CHARACTERISTICS (Values Apply For Each Operational Amplifier)

CHARACTERISTIC	TEST CONDITIONS Supply Voltage (V^+) = 5 V Unless Otherwise Specified	LIMITS CA158A (E, T, S)			UNITS
		Min.	Typ.	Max.	
$T_A = 25^\circ\text{C}$					
Input Offset Voltage, V_{IO}	Note 3	–	1	2	mV
Output Voltage Swing, V_{OPP}	$R_L = 2\text{ k}\Omega$	0	–	$V^+ - 1.5$	V
Input Common-Mode Voltage Range, V_{ICR}	Note 2, $V^+ = 30\text{ V}$	0	–	$V^+ - 1.5$	V
Input Offset Current, I_{IO}	$I_1^+ - I_1^-$	–	2	10	nA
Input Bias Current, I_{IB}	I_1^+ or I_1^- , Note 1	–	20	50	nA
Output Current (Source), I_O	$V_1^+ = +1\text{ V}$, $V_1^- = 0\text{ V}$, $V^+ = 15\text{ V}$	20	40	–	mA
Output Current (Sink), I_O	$V_1^+ = 0\text{ V}$, $V_1^- = 1\text{ V}$, $V^+ = 15\text{ V}$	10	20	–	mA
	$V_1^+ = 0\text{ V}$, $V_1^- = 1\text{ V}$, $V_O = 200\text{ mV}$	12	50	–	μA
Short Circuit Output Current	$R_L = 0$ (to Ground) Note 4	–	40	60	mA
Large Signal Voltage Gain, A_{OL}	$R_L \geq 2\text{ k}\Omega$, $V^+ = 15\text{ V}$ (For large V_O swing)	50	100	–	V/mV
Common-Mode Rejection Ratio, CMRR	DC	70	85	–	dB
Power Supply Rejection Ratio, PSRR	DC	65	100	–	dB
Amplifier-to-Amplifier Coupling	$f = 1$ to 20 kHz (Input referred)	–	–120	–	dB
$T_A = -55$ to $+125^\circ\text{C}$					
Input Offset Voltage, V_{IO}	Note 3	–	–	4	mV
Temperature Coefficient of Input Offset Voltage, αV_{IO}	$R_S = 0$	–	7	15	$\mu\text{V}/^\circ\text{C}$
Input Offset Current, I_{IO}	$I_1^+ - I_1^-$	–	–	30	nA
Temperature Coefficient of Input Offset Current, αI_{IO}		–	10	200	$\text{pA}/^\circ\text{C}$
Input Bias Current, I_{IB}	I_1^+ or I_1^-	–	40	100	nA
Input Common-Mode Voltage Range, V_{ICR}	$V^+ = 30\text{ V}$, Note 2	0	–	$V^+ - 2$	V
Supply Current, I^+	$R_L = \infty$ On All Ampl.	–	0.7	1.2	mA
	$R_L = \infty$, $V^+ = 30\text{ V}$	–	1.5	3	

NOTE 1: Due to the p-n-p input stage the direction of the input current is out of the IC. No loading change exists on the input lines because this current is essentially constant, independent of the state of the output.

NOTE 2: The input signal voltages and the input common-mode voltage should not be allowed to go negative by more than 0.3 V. The positive limit of the common-mode voltage range is $V^+ - 1.5\text{ V}$, but either or both inputs can go the $+32\text{ V}$ without damage.

NOTE 3: $V_O = 1.4\text{ V}_{DC}$, $R_S = 0\ \Omega$ with V^+ from 5 V to 30 V, and over the full input common-mode voltage range (0 V to $V^+ - 1.5\text{ V}$).

NOTE 4: The maximum output current is approximately 40 mA independent of the magnitude of V^+ . Continuous short circuits at $V^+ > 15\text{ V}$ can cause excessive power dissipation and eventual destruction. Short circuits from the output to V^+ can cause overheating and eventual destruction of the device. Destructive dissipation can result from simultaneous short circuits on both amplifiers.

Operational Amplifiers

CA158, CA158A, CA258, CA258A, CA358, CA358A, CA2904, LM358, LM2904

ELECTRICAL CHARACTERISTICS (Values Apply for Each Operational Amplifier)

CHARACTERISTIC	TEST CONDITIONS	LIMITS CA258A (E, T, S)			UNITS
		Supply Voltage (V^+) = 5 V Unless Otherwise Specified	Min.	Typ.	
	$T_A = 25^\circ\text{C}$				
Input Offset Voltage, V_{IO}	Note 3	–	1	3	mV
Output Voltage Swing, V_{OPP}	$R_L = 2\text{ k}\Omega$	0	–	$V^+ - 1.5$	V
Input Common-Mode Voltage Range, V_{ICR}	Note 2, $V^+ = 30\text{ V}$	0	–	$V^+ - 1.5$	V
Input Offset Current, I_{IO}	$I_1^+ - I_1^-$	–	2	15	nA
Input Bias Current, I_{IB}	I_1^+ or I_1^- , Note 1	–	40	80	nA
Output Current (Source), I_O	$V_1^+ = +1\text{ V}$, $V_1^- = 0\text{ V}$, $V_O = 15\text{ V}$	20	40	–	mA
Output Current (Sink), I_O	$V_1^+ = 0\text{ V}$, $V_1^- = 1\text{ V}$, $V^+ = 15\text{ V}$	10	20	–	mA
	$V_1^+ = 0\text{ V}$, $V_1^- = 1\text{ V}$, $V_O = 200\text{ mV}$	12	50	–	μA
	Short Circuit Output Current	$R_L = 0$ (to Ground) Note 4	–	40	60
Large Signal Voltage Gain, A_{OL}	$R_L \geq 2\text{ k}\Omega$, $V^+ = 15\text{ V}$ (For large V_O swing)	50	100	–	V/mV
Common-Mode Rejection Ratio, CMRR	DC	70	85	–	dB
Power Supply Rejection Ratio, PSRR	DC	65	100	–	dB
Amplifier-to-Amplifier Coupling	$f = 1$ to 20 kHz (Input referred)	–	–120	–	dB
$T_A = -25$ to $+85^\circ\text{C}$					
Input Offset Voltage, V_{IO}	Note 3	–	–	4	mV
Temperature Coefficient of Input Offset Voltage, αV_{IO}	$R_S = 0$	–	7	15	$\mu\text{V}/^\circ\text{C}$
Input Offset Current, I_{IO}	$I_1^+ - I_1^-$	–	–	30	nA
Temperature Coefficient of Input Offset Current, αI_{IO}		–	10	200	$\text{pA}/^\circ\text{C}$
Input Bias Current, I_{IB}	I_1^+ or I_1^-	–	40	100	nA
Input Common-Mode Voltage Range, V_{ICR}	$V^+ = 30\text{ V}$, Note 2	0	–	$V^+ - 2$	V
Supply Current, I^+	$R_L = \infty$ On All Ampl.	–	0.7	1.2	mA
	$R_L = \infty$, $V^+ = 30\text{ V}$	–	1.5	3	

NOTE 1: Due to the p-n-p input stage the direction of the input current is out of the IC. No loading change exists on the input lines because this current is essentially constant, independent of the state of the output.

NOTE 2: The input signal voltages and the input common-mode voltage should not be allowed to go negative by more than 0.3 V. The positive limit of the common-mode voltage range is $V^+ - 1.5\text{ V}$, but either or both inputs can go the + 32 V without damage.

NOTE 3: $V_O = 1.4\text{ V}_{DC}$, $R_S = 0\ \Omega$ with V^+ from 5 V to 30 V, and over the full input common-mode voltage range (0 V to $V^+ - 1.5\text{ V}$).

NOTE 4: The maximum output current is approximately 40 mA independent of the magnitude of V^+ . Continuous short circuits at $V^+ > 15\text{ V}$ can cause excessive power dissipation and eventual destruction. Short circuits from the output to V^+ can cause overheating and eventual destruction of the device. Destructive dissipation can result from simultaneous short circuits on both amplifiers.

CA158, CA158A, CA258, CA258A, CA358, CA358A, CA2904, LM358, LM2904

ELECTRICAL CHARACTERISTICS (Values Apply for Each Operational Amplifier)

CHARACTERISTIC	TEST CONDITIONS	LIMITS CA358A (E. T. S)			UNITS
		Supply Voltage (V^+) = 5 V Unless Otherwise Specified	Min.	Typ.	
$T_A = 25^\circ\text{C}$					
Input Offset Voltage, V_{IO}	Note 3	–	2	3	mV
Output Voltage Swing, V_{OPP}	$R_L = 2\text{ k}\Omega$	0	–	$V^+ - 1.5$	V
Input Common-Mode Voltage Range, V_{ICR}	Note 2, $V^+ = 30\text{ V}$	0	–	$V^+ - 1.5$	V
Input Offset Current, I_{IO}	$I_1^+ - I_1^-$	–	5	30	nA
Input Bias Current, I_{IB}	I_1^+ or I_1^- , Note 1	–	45	100	nA
Output Current (Source), I_O	$V_1^+ = +1\text{ V}$, $V_1^- = 0\text{ V}$, $V^+ = 15\text{ V}$	20	40	–	mA
Output Current (Sink), I_O	$V_1^+ = 0\text{ V}$, $V_1^- = 1\text{ V}$, $V^+ = 15\text{ V}$	10	20	–	mA
	$V_1^+ = 0\text{ V}$, $V_1^- = 1\text{ V}$, $V_O = 200\text{ mV}$	12	50	–	μA
Short Circuit Output Current	$R_L = 0$ (to Ground) Note 4	–	40	60	mA
Large Signal Voltage Gain, A_{OL}	$R_L \geq 2\text{ k}\Omega$, $V^+ = 15\text{ V}$ (For large V_O swing)	25	100	–	V/mV
Common-Mode Rejection Ratio, CMRR	DC	65	85	–	dB
Power Supply Rejection Ratio, PSRR	DC	65	100	–	dB
Amplifier-to-Amplifier Coupling	$f = 1$ to 20 kHz (Input referred)	–	–120	–	dB
$T_A = 0$ to $+70^\circ\text{C}$					
Input Offset Voltage, V_{IO}	Note 3	–	–	5	mV
Temperature Coefficient of Input Offset Voltage, αV_{IO}	$R_S = 0$	–	7	20	$\mu\text{V}/^\circ\text{C}$
Input Offset Current, I_{IO}	$I_1^+ - I_1^-$	–	–	75	nA
Temperature Coefficient of Input Offset Current, αI_{IO}		–	10	300	$\text{pA}/^\circ\text{C}$
Input Bias Current, I_{IB}	I_1^+ or I_1^-	–	40	200	nA
Input Common-Mode Voltage Range, V_{ICR}	$V^+ = 30\text{ V}$, Note 2	0	–	$V^+ - 2$	V
Supply Current, I^+	$R_L = \infty$ On All Ampl.	–	0.7	1.2	mA
	$R_L = \infty$, $V^+ = 30\text{ V}$	–	1.5	3	

NOTE 1: Due to the p-n-p input stage the direction of the input current is out of the IC. No loading change exists on the input lines because this current is essentially constant, independent of the state of the output.

NOTE 2: The input signal voltages and the input common-mode voltage should not be allowed to go negative by more than 0.3 V. The positive limit of the common-mode voltage range is $V^+ - 1.5\text{ V}$, but either or both inputs can go the $+32\text{ V}$ without damage.

NOTE 3: $V_O = 1.4\text{ V}_{DC}$, $R_S = 0\ \Omega$ with V^+ from 5 V to 30 V, and over the full input common-mode voltage range (0 V to $V^+ - 1.5\text{ V}$).

NOTE 4: The maximum output current is approximately 40 mA independent of the magnitude of V^+ . Continuous short circuits at $V^+ > 15\text{ V}$ can cause excessive power dissipation and eventual destruction. Short circuits from the output to V^+ can cause overheating and eventual destruction of the device. Destructive dissipation can result from simultaneous short circuits on both amplifiers.

CA158, CA158A, CA258, CA258A, CA358, CA358A, CA2904, LM358, LM2904

ELECTRICAL CHARACTERISTICS (Values Apply for Each Operational Amplifier)

CHARACTERISTIC	TEST CONDITIONS	LIMITS CA158 (E, T, S) CA258 (E, T, S)			UNITS
		Supply Voltage (V^+) = 5 V Unless Otherwise Specified	Min.	Typ.	
$T_A = 25^\circ\text{C}$					
Input Offset Voltage, V_{IO}	Note 3	–	2	5	mV
Output Voltage Swing, V_{OPP}	$R_L = 2\text{ k}\Omega$	0	–	$V^+ - 1.5$	V
Input Common-Mode Voltage Range, V_{ICR}	Note 2, $V^+ = 30\text{ V}$	0	–	$V^+ - 1.5$	V
Input Offset Current, I_{IO}	$I_1^+ - I_1^-$	–	3	30	nA
Input Bias Current, I_{IB}	I_1^+ or I_1^- , Note 1	–	45	150	nA
Output Current (Source), I_O	$V_1^+ = +1\text{ V}$, $V_1^- = 0\text{ V}$, $V^+ = 15\text{ V}$	20	40	–	mA
Output Current (Sink), I_O	$V_1^+ = 0\text{ V}$, $V_1^- = 1\text{ V}$, $V^+ = 15\text{ V}$	10	20	–	mA
	$V_1^+ = 0\text{ V}$, $V_1^- = 1\text{ V}$, $V_O = 200\text{ mV}$	12	50	–	μA
Short Circuit Output Current	$R_L = 0$ (to Ground) Note 4	–	40	60	mA
Large Signal Voltage Gain, A_{OL}	$R_L \geq 2\text{ k}\Omega$, $V^+ = 15\text{ V}$ (For large V_O swing)	50	100	–	V/mV
Common-Mode Rejection Ratio, CMRR	DC	70	85	–	dB
Power Supply Rejection Ratio, PSRR	DC	65	100	–	dB
Amplifier-to-Amplifier Coupling	$f = 1$ to 20 kHz (Input referred)	–	–120	–	dB
$T_A = -55\text{ to } +125^\circ\text{C}$ (CA158); $T_A = -25\text{ to } +85^\circ\text{C}$ (CA258)					
Input Offset Voltage, V_{IO}	Note 3	–	–	7	mV
Temperature Coefficient of Input Offset Voltage, αV_{IO}	$R_S = 0$	–	7	–	$\mu\text{V}/^\circ\text{C}$
Input Offset Current, I_{IO}	$I_1^+ - I_1^-$	–	–	100	nA
Temperature Coefficient of Input Offset Current, αI_{IO}		–	10	–	$\mu\text{A}/^\circ\text{C}$
Input Bias Current, I_{IB}	I_1^+ or I_1^-	–	40	300	nA
Input Common-Mode Voltage Range, V_{ICR}	$V^+ = 30\text{ V}$, Note 2	0	–	$V^+ - 2$	V
Supply Current, I^+	$R_L = \infty$ On All Ampl.	–	0.7	1.2	mA
	$R_L = \infty$, $V^+ = 30\text{ V}$	–	1.5	3	

NOTE 1: Due to the p-n-p input stage the direction of the input current is out of the IC. No loading change exists on the input lines because this current is essentially constant, independent of the state of the output.

NOTE 2: The input signal voltages and the input common-mode voltage should not be allowed to go negative by more than 0.3 V. The positive limit of the common-mode voltage range is $V^+ - 1.5\text{ V}$, but either or both inputs can go the $+32\text{ V}$ without damage.

NOTE 3: $V_O = 1.4\text{ V}_{DC}$, $R_S = 0\ \Omega$ with V^+ from 5 V to 30 V, and over the full input common-mode voltage range (0 V to $V^+ - 1.5\text{ V}$).

NOTE 4: The maximum output current is approximately 40 mA independent of the magnitude of V^+ . Continuous short circuits at $V^+ > 15\text{ V}$ can cause excessive power dissipation and eventual destruction. Short circuits from the output to V^+ can cause overheating and eventual destruction of the device. Destructive dissipation can result from simultaneous short circuits on both amplifiers.

CA158, CA158A, CA258, CA258A, CA358, CA358A, CA2904, LM358, LM2904

ELECTRICAL CHARACTERISTICS (Values Apply for Each Operational Amplifier)

CHARACTERISTIC	TEST CONDITIONS	LIMITS CA358 (E, T, S)			UNITS
		Min.	Typ.	Max.	
T_A = 25°C					
Input Offset Voltage, V _{IO}	Note 3	–	2	7	mV
Output Voltage Swing, V _{OPP}	R _L = 2 kΩ	0	–	V ⁺ – 1.5	V
Input Common-Mode Voltage Range, V _{ICR}	Note 2, V ⁺ = 30 V	0	–	V ⁺ – 1.5	V
Input Offset Current, I _{IO}	I ₁ ⁺ – I ₁ [–]	–	5	50	nA
Input Bias Current, I _{IB}	I ₁ ⁺ or I ₁ [–] , Note 1	–	45	250	nA
Output Current (Source), I _O	V ₁ ⁺ = +1 V, V ₁ [–] = 0 V, V _O = 15 V	20	40	–	mA
Output Current (Sink), I _O	V ₁ ⁺ = 0 V, V ₁ [–] = 1 V, V _O = 15 V	10	20	–	mA
	V ₁ ⁺ = 0 V, V ₁ [–] = 1 V, V _O = 200 mV	12	50	–	μA
Short Circuit Output Current	R _L = 0 (to Ground) Note 4	–	40	60	mA
Large Signal Voltage Gain, A _{OL}	R _L ≥ 2 kΩ, V ⁺ = 15 V (For large V _O swing)	25	100	–	V/mV
Common-Mode Rejection Ratio, CMRR	DC	65	70	–	dB
Power Supply Rejection Ratio, PSRR	DC	65	100	–	dB
Amplifier-to-Amplifier Coupling	f = 1 to 20 kHz (Input referred)	–	–120	–	dB
T_A = 0 to +70°C					
Input Offset Voltage, V _{IO}	Note 3	–	–	9	mV
Temperature Coefficient of Input Offset Voltage, αV _{IO}	R _s = 0	–	7	–	μV/°C
Input Offset Current, I _{IO}	I ₁ ⁺ – I ₁ [–]	–	–	150	nA
Temperature Coefficient of Input Offset Current, αI _{IO}		–	10	–	pA/°C
Input Bias Current, I _{IB}	I ₁ ⁺ or I ₁ [–]	–	40	500	nA
Input Common-Mode Voltage Range, V _{ICR}	V ⁺ = 30 V, Note 2	0	–	V ⁺ – 2	V
Supply Current, I ⁺	R _L = ∞ On All Ampl.	–	0.7	1.2	mA
	R _L = ∞, V ⁺ = 30 V	–	1.5	3	

NOTE 1: Due to the p-n-p input stage the direction of the input current is out of the IC. No loading change exists on the input lines because this current is essentially constant, independent of the state of the output.

NOTE 2: The input signal voltages and the input common-mode voltage should not be allowed to go negative by more than 0.3 V. The positive limit of the common-mode voltage range is V⁺ – 1.5 V, but either or both inputs can go the +32 V without damage.

NOTE 3: V_O = 1.4 V_{DC}, R_s = 0 Ω with V⁺ from 5 V to 30 V, and over the full input common-mode voltage range (0 V to V⁺ – 1.5 V).

NOTE 4: The maximum output current is approximately 40 mA independent of the magnitude of V⁺. Continuous short circuits at V⁺ > 15 V can cause excessive power dissipation and eventual destruction. Short circuits from the output to V⁺ can cause overheating and eventual destruction of the device. Destructive dissipation can result from simultaneous short circuits on both amplifiers.

CA158, CA158A, CA258, CA258A, CA358, CA358A, CA2904, LM358, LM2904

ELECTRICAL CHARACTERISTICS (Values Apply for Each Operational Amplifier)

CHARACTERISTIC	TEST CONDITIONS	LIMITS CA2904E			UNITS
		Supply Voltage (V ⁺) = 5 V Unless Otherwise Specified	Min.	Typ.	
T_A = 25°C					
Input Offset Voltage, V _{IO}	Note 3	–	2	7	mV
Output Voltage Swing, V _{OPP}	R _L = 10 kΩ	0	–	V ⁺ – 1.5	V
Input Common-Mode Voltage Range, V _{ICR}	Note 2, V ⁺ = 30 V	0	–	V ⁺ – 1.5	V
Input Offset Current, I _{IO}	I ₁ ⁺ – I ₁ [–]	–	5	50	nA
Input Bias Current, I _{IB}	I ₁ ⁺ or I ₁ [–] , Note 1	–	45	250	nA
Output Current (Source), I _O	V ₁ ⁺ = +1 V, V ₁ [–] = 0 V, V ⁺ = 15 V	20	40	–	mA
Output Current (Sink), I _O	V ₁ ⁺ = 0 V, V ₁ [–] = 1 V, V ⁺ = 15 V	10	20	–	mA
Short Circuit Output Current	R _L = 0 (to Ground) Note 4	–	40	60	mA
Large Signal Voltage Gain, A _{OL}	R _L ≥ 2 kΩ, V ⁺ = 15 V (For large V _O swing)	–	100	–	V/mV
Common-Mode Rejection Ratio, CMRR	DC	50	70	–	dB
Power Supply Rejection Ratio, PSRR	DC	50	100	–	dB
Amplifier-to-Amplifier Coupling	f = 1 to 20 kHz (Input referred)	–	–120	–	dB
T_A = –40 to +85°C					
Input Offset Voltage, V _{IO}	Note 3	–	–	10	mV
Temperature Coefficient of Input Offset Voltage, αV _{IO}	R _S = 0	–	7	–	μV/°C
Input Offset Current, I _{IO}	I ₁ ⁺ – I ₁ [–]	–	45	200	nA
Temperature Coefficient of Input Offset Current, αI _{IO}		–	10	–	pA/°C
Input Bias Current, I _{IB}	I ₁ ⁺ or I ₁ [–]	–	40	500	nA
Input Common-Mode Voltage Range, V _{ICR}	V ⁺ = 30 V, Note 2	0	–	V ⁺ – 2	V
Supply Current, I ⁺	R _L = ∞ On All Ampl.	–	0.7	1.2	mA
	R _L = ∞, V ⁺ = 30 V	–	1.5	3	

NOTE 1: Due to the p-n-p input stage the direction of the input current is out of the IC. No loading change exists on the input lines because this current is essentially constant, independent of the state of the output.

NOTE 2: The input signal voltages and the input common-mode voltage should not be allowed to go negative by more than 0.3 V. The positive limit of the common-mode voltage range is V⁺ – 1.5 V, but either or both inputs can go the +32 V without damage.

NOTE 3: V_O = 1.4 V_{DC}, R_S = 0 Ω with V⁺ from 5 V to 30 V, and over the full input common-mode voltage range (0 V to V⁺ – 1.5 V).

NOTE 4: The maximum output current is approximately 40 mA independent of the magnitude of V⁺. Continuous short circuits at V⁺ > 15 V can cause excessive power dissipation and eventual destruction. Short circuits from the output to V⁺ can cause overheating and eventual destruction of the device. Destructive dissipation can result from simultaneous short circuits on both amplifiers.

CA158, CA158A, CA258, CA258A, CA358, CA358A, CA2904, LM358, LM2904

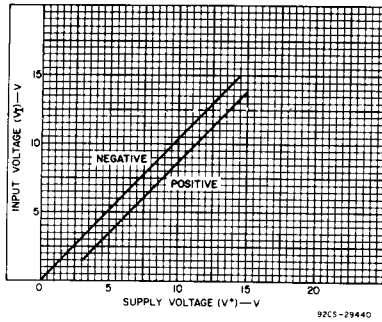

Fig. 4 — Input voltage range as a function of supply voltage.

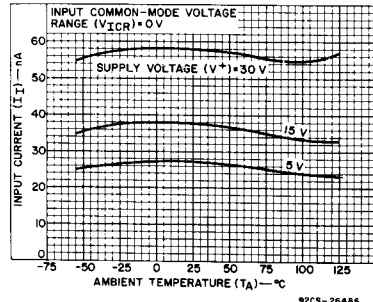

Fig. 5 — Input current as a function of ambient temperature.

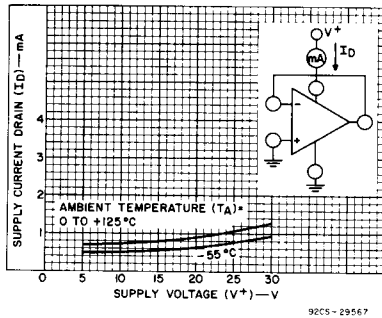

Fig. 6 — Supply current drain as a function of supply voltage.

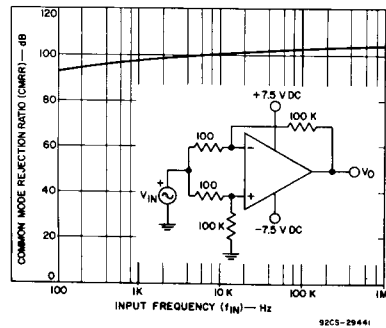

Fig. 7 — Common mode rejection ratio as a function of input frequency.

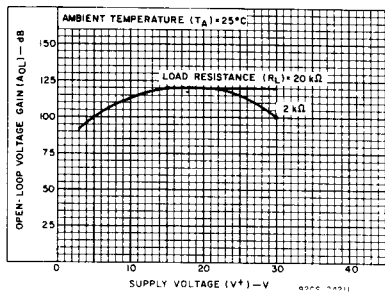

Fig. 8 — Voltage gain as a function of supply voltage.

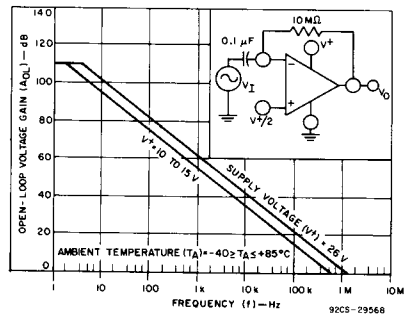

Fig. 9 — Open-loop frequency response.

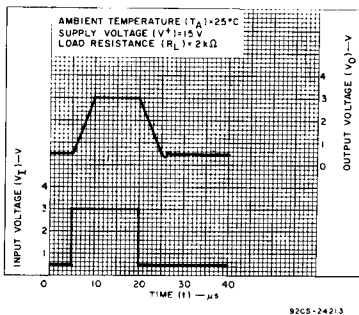

Fig. 10 — Voltage follower pulse response.

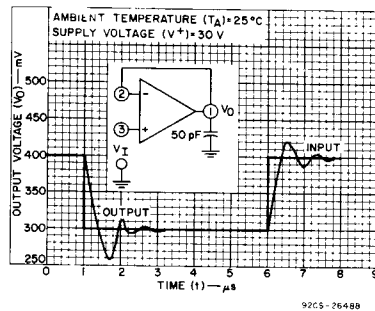

Fig. 11 — Voltage follower pulse response (small signal).

Operational Amplifiers

CA158, CA158A, CA258, CA258A, CA358, CA358A, CA2904, LM358, LM2904

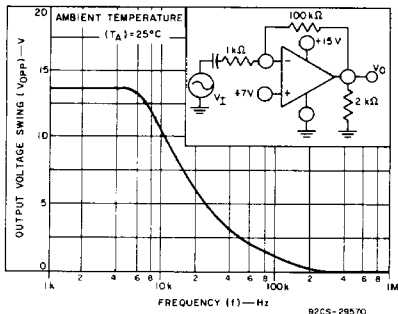

Fig. 12 — Large-signal frequency response.

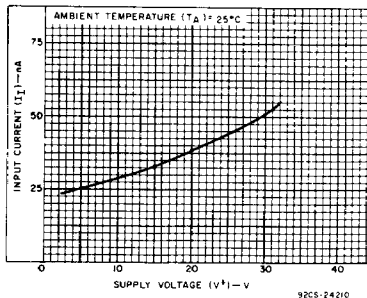

Fig. 13 — Input current as a function of supply voltage.

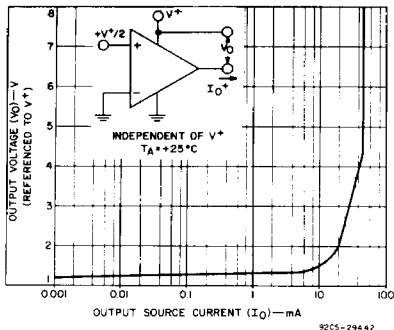

Fig. 14 — Output source current characteristics.

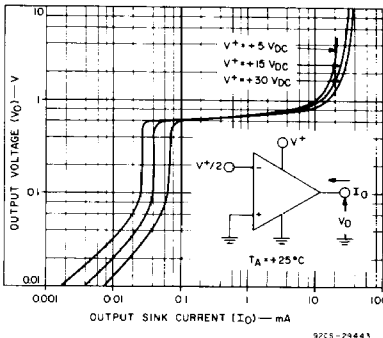

Fig. 15 — Output sink current characteristics.

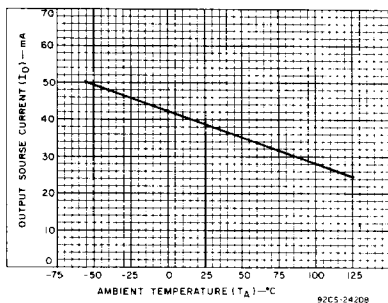

Fig. 16 — Output current as a function of ambient temperature.

ORDERING INFORMATION

These packages are identified by Suffix Letters indicated in the chart shown below. When ordering these devices, it is important that the appropriate suffix letter be affixed to the type number of the device required.

PACKAGE	SUFFIX LETTERS	TYPES
8-Lead Dual-In-Line Plastic with	E	CA158, A CA258, A CA358, A CA2904
8-Lead TO-5 Style with Standard Leads	T	CA158, A CA258, A
8-Lead TO-5 Style with Dual-In-Line Formed Leads	S	CA358, A

**CA158, CA158A, CA258, CA258A, CA358,
CA358A, CA2904, LM358, LM2904**

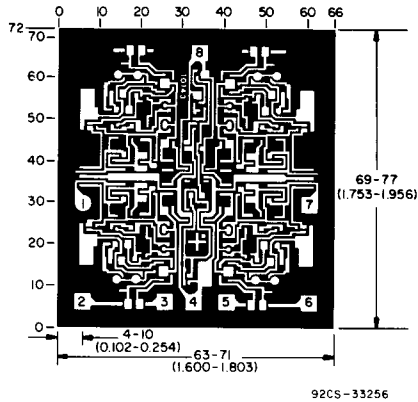

Dimensions and pad layout for CA358H..

Dimensions in parentheses are in millimeters and are derived from the basic inch dimensions as indicated. Grid graduations are in mils (10^{-3} inch).

The photographs and dimensions represent a chip when it is part of the wafer. When the wafer is cut into chips, the cleavage angles are 57° instead of 90° with respect to the face of the chip. Therefore, the isolated chip is actually 7 mils (0.17 mm) larger in both dimensions.