

## 200W LOW CAPACITANCE FLIP CHIP TVS ARRAY

### DESCRIPTION

The LC0402FCxxC Series Flip Chips employ advanced silicon P/N junction technology for unmatched board-level transient voltage protection against Electrostatic Discharge (ESD) and Electrical Fast Transients (EFT). Developed specifically for high-density circuit protection, this series meets the IEC 61000-4-2 and 61000-4-4 requirements. These devices are ideally suited for handheld devices, PCMCIA and SMART cards.

This low capacitance series provides ESD protection greater than 25 kilovolts with a peak pulse power dissipation of 200 Watts per line for an 8/20 $\mu$ s waveform. In addition, the LC0402FCxxC series features superior clamping performance, low leakage current characteristics and a response time of less than a nanosecond. Their low inductance virtually eliminates overshoot voltage due to package inductance.

### FEATURES

- Compatible with IEC 61000-4-2 (ESD): Air 15kV, Contact 8kV
- Compatible with IEC 61000-4-4 (EFT): 40A, 5/50ns
- ESD Protection > 25 kilovolts
- Available in Voltages Ranging from 3.3V to 36V
- 200 Watts Peak Pulse Power per Line (tp = 8/20 $\mu$ s)
- Bidirectional and Monolithic Structure
- Low Clamping Voltage
- Low Capacitance
- Low Leakage Current
- Protection for 1 Line
- RoHS Compliant
- REACH Compliant

### APPLICATIONS

- SMART Phones
- Portable Electronics
- SMART Cards

### MECHANICAL CHARACTERISTICS

- Standard EIA Chip Size: 0402
- Approximate Weight: 0.73 milligrams
- Lead-Free Plating
- Solder Reflow Temperature:
  - Lead-Free - Sn/Ag/Cu, 96/3.5/0.5: 260-270°C
- Flammability Rating UL 94V-0
- 8mm Tape per EIA Standard 481
- Top Contacts: Solder Bump 0.004" in Height (Nominal)

### PIN CONFIGURATION



**TYPICAL DEVICE CHARACTERISTICS**
**MAXIMUM RATINGS @ 25°C Unless Otherwise Specified**

PARAMETER	SYMBOL	VALUE	UNITS
Peak Pulse Power (tp = 8/20μs) - See Figure 1	P <sub>PP</sub>	200	Watts
Operating Temperature	T <sub>A</sub>	-55 to 150	°C
Storage Temperature	T <sub>STG</sub>	-55 to 150	°C

**ELECTRICAL CHARACTERISTICS PER LINE @ 25°C Unless Otherwise Specified**

PART NUMBER (Note 1)	RATED STAND-OFF VOLTAGE  V <sub>WM</sub> VOLTS	MINIMUM BREAKDOWN VOLTAGE  @ 1mA V <sub>(BR)</sub> VOLTS	MAXIMUM CLAMPING VOLTAGE (Fig. 2)  @ I <sub>p</sub> = 1A V <sub>c</sub> VOLTS	MAXIMUM CLAMPING VOLTAGE (Fig. 2)  @ 8/20μS V <sub>c</sub> @ I <sub>PP</sub>	MAXIMUM LEAKAGE CURRENT (Note 2)  @ V <sub>WM</sub> I <sub>D</sub> μA	TYPICAL CAPACITANCE  @ 0V, 1MHz C pF
LC0402FC3.3C	3.3	4.0	7.0	12.5V @ 16A	75*	70
LC0402FC05C	5.9	6.0	11.0	13.0V @ 15A	10**	35
LC0402FC08C	8.0	8.5	13.2	18.0V @ 11A	1	32
LC0402FC12C	12.0	13.3	19.8	26.9V @ 7.4A	1	30
LC0402FC15C	15.0	16.7	25.4	34.5V @ 5.8A	1	25
LC0402FC24C	24.0	26.7	37.2	50.6V @ 4A	1	20
LC0402FC36C	36.0	40.0	70.0	80.0V @ 2.5A	1	18

**NOTES**

- All devices are bidirectional. Electrical characteristics apply in both directions.
- \*Maximum leakage current < 5μA @ 2.8V. \*\*Maximum leakage current < 500nA @ 3.3V.

TYPICAL DEVICE CHARACTERISTICS

FIGURE 1  
PEAK PULSE POWER VS PULSE TIME

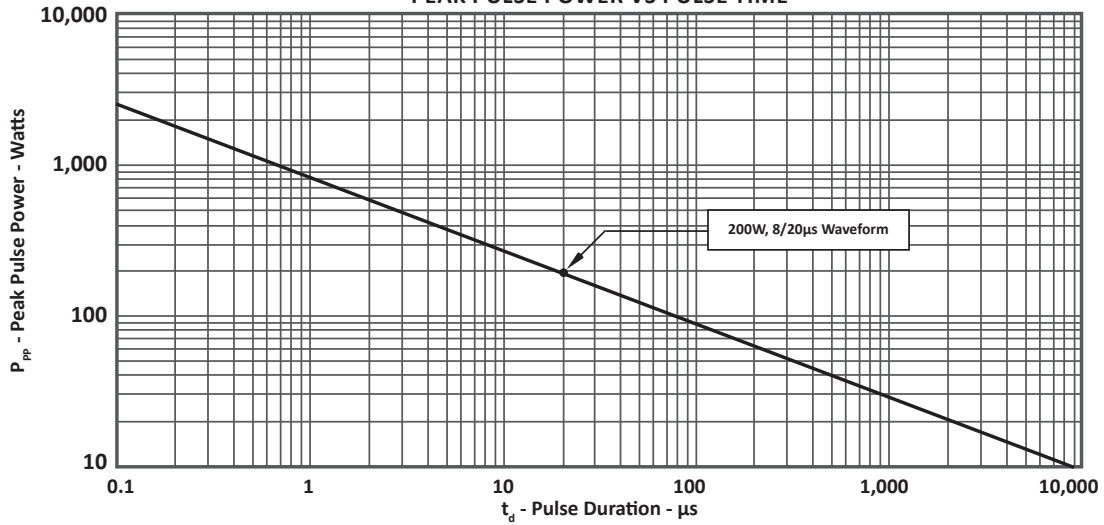

FIGURE 2  
PULSE WAVE FORM

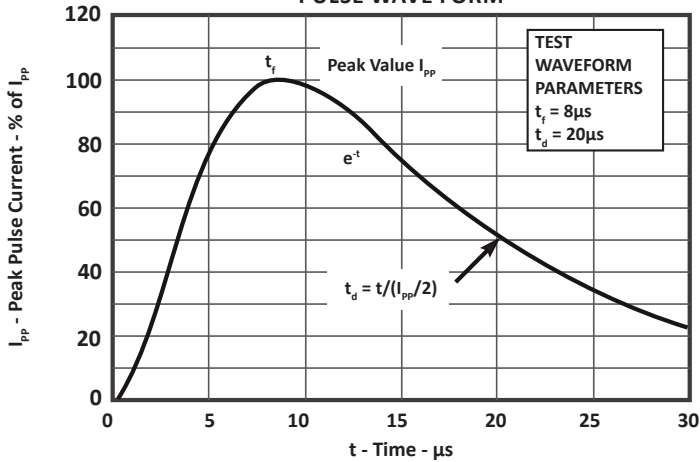
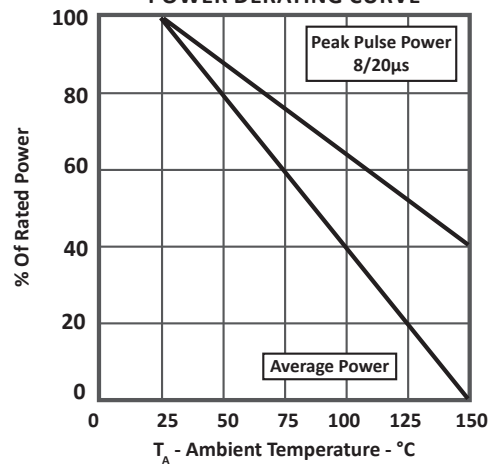
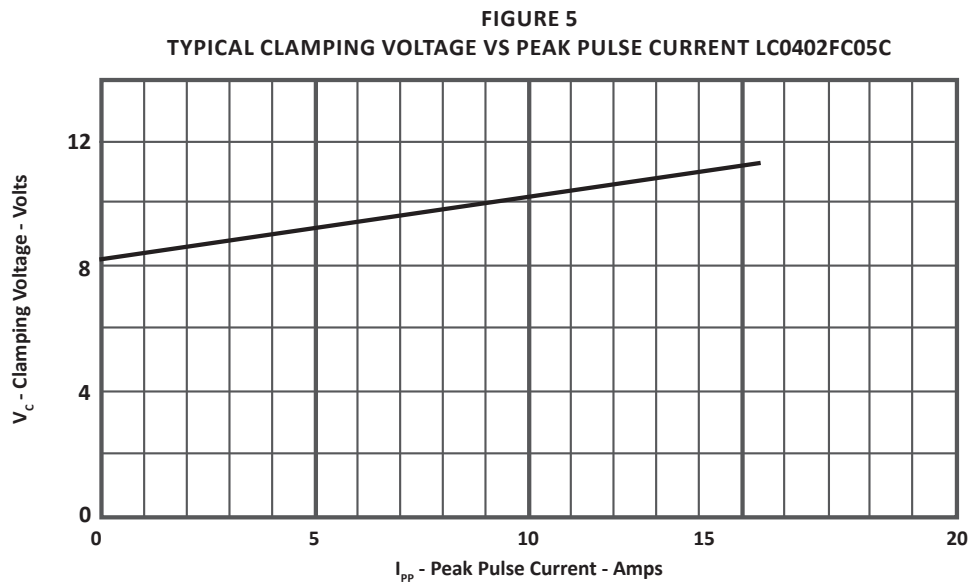
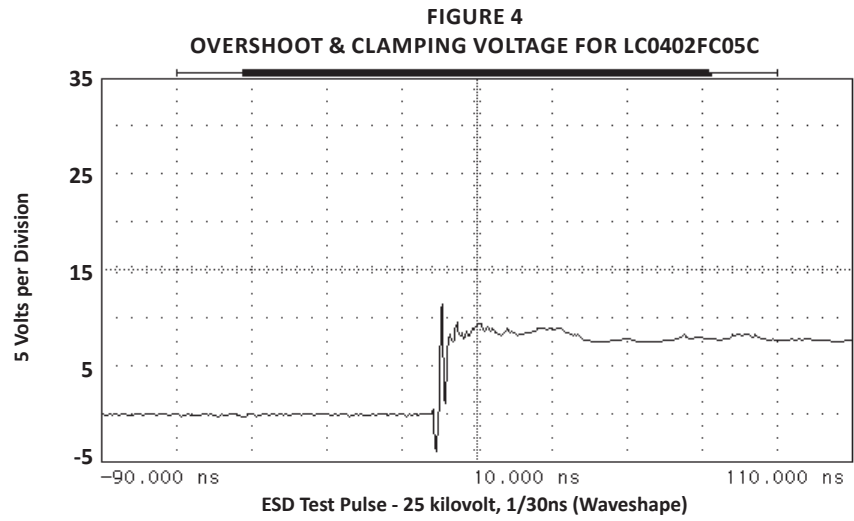

FIGURE 3  
POWER DERATING CURVE



## TYPICAL DEVICE CHARACTERISTICS



## SPICE MODEL

FIGURE 1  
SPICE MODEL FOR

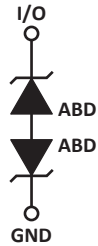

ABD - Avalanche Breakdown Diode (TVS)

TABLE 1 - SPICE PARAMETERS		
PARAMETER	UNIT	ABD(TVS)
BV	V	See Table 2
IBV	$\mu$ A	1
$C_{jo}$	pF	See Table 2
$I_s$	A	See Table 2
Vj	V	0.6
M	-	0.33
N	-	1
$R_s$	-	See Table 2
TT	s	1E-8
EG	eV	1.11

TABLE 2 - ABD SPECIFIC SPICE PARAMETERS				
PART NUMBER	$B_v$ (VOLTS)	$C_{jo}$ (pF)	$I_s$ (AMPS)	$R_s$ (OHMS)
LC0402FC3.3C	4.0	70	1E-11	0.20
LC0402FC05C	6.0	35	1E-11	0.16
LC0402FC08C	8.5	32	1E-13	0.33
LC0402FC12C	13.3	30	1E-13	0.51
LC0402FC15C	16.7	25	1E-13	0.53
LC0402FC24C	26.7	20	1E-13	0.63
LC0402FC36C	40.2	18	1E-13	0.73

## SOLDER REFLOW INFORMATION

PRINTED CIRCUIT BOARD RECOMMENDATIONS	
PARAMETER	VALUE
Pad Size on PCB	0.275mm
Pad Shape	Round
Pad Definition	Non-Solder Mask Defined Pads
Solder Mask Opening	0.325mm Round
Solder Stencil Thickness	0.150mm
Solder Stencil Aperture Opening (Laser cut, 5% tapered walls)	0.330mm Round
Solder Paste Type	No Clean
Pad Protective Finish	OSP (Entek Cu Plus 106A)
Tolerance - Edge To Corner Ball	±50µm
Solder Ball Side Coplanarity	±20µm
Maximum Dwell Time Above Liquidous (183°C)	60 seconds
Soldering Maximum Temperature	270°C

### REQUIREMENTS

Temperature:

$T_p$  for Lead-Free (Sn/Ag/Cu): 260-270°C

$T_p$  for Tin-Lead: 240-245°C

Preheat time and temperature depends on solder paste and flux activation temperature, component size, weight, surface area and plating.

### RECOMMENDED NON-SOLDER MASK DEFINED PAD ILLUSTRATION

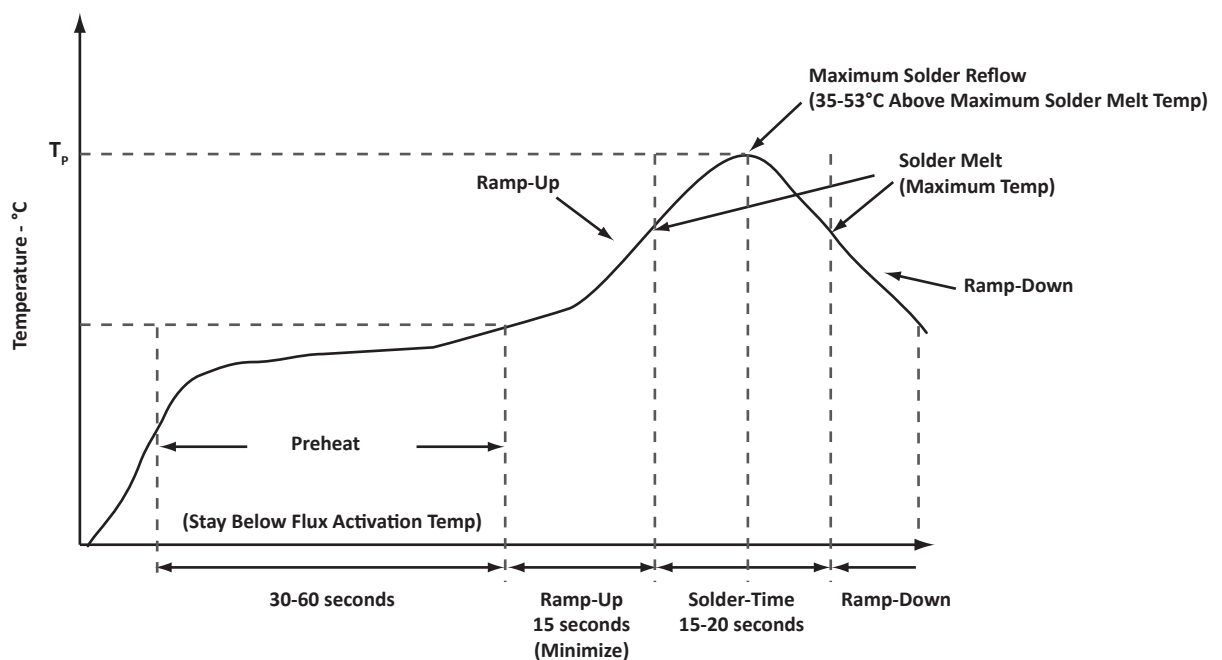
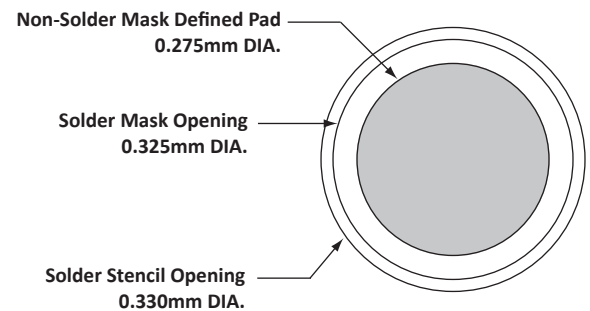

## 0402 PACKAGE INFORMATION

## OUTLINE DIMENSIONS

DIM	MILLIMETERS		INCHES	
	MIN	MAX	MIN	MAX
A	0.46		0.018	
B	0.86		0.034	
C	0.98	1.02	0.038	0.040
D	0.10		0.004	
E	0.35		0.014	
F	0.458	0.508	0.018	0.020
G	0.20		0.008	
H	0.076	0.127	0.003	0.005
I	0.406		0.016	

## NOTES

- Controlling dimensions in inches.
- Decimal tolerance: .xxx ± 0.05mm (0.002").
- Maximum chip size: 1.02mm (0.040") by 0.51mm (0.020").

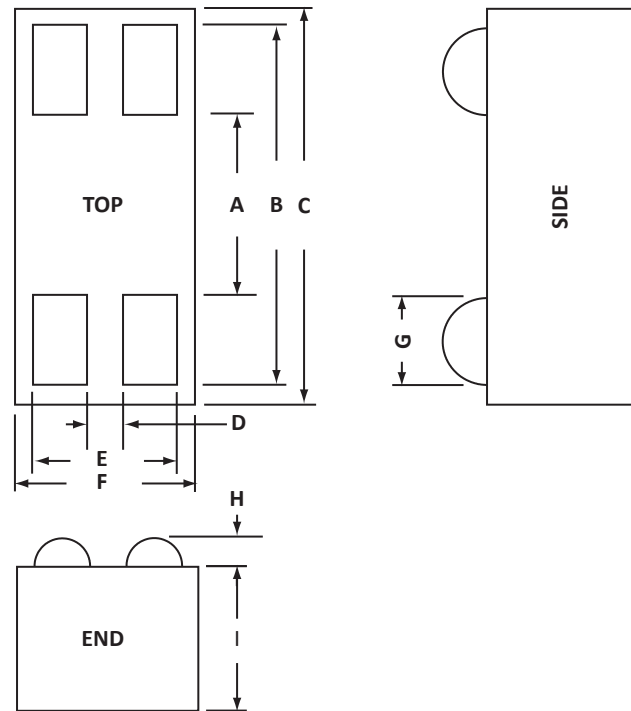

## LAYOUT DIMENSIONS

DIM	MILLIMETERS	INCHES
	NOMINAL	NOMINAL
A	0.23	0.009
B	0.48	0.019
C	0.69	0.027
D	0.46	0.018
E	0.99	0.039
F	0.20	0.008
G	0.20	0.008
H	0.66	0.026
I	0.13	0.005

## NOTES

- Controlling dimensions in inches.
- Decimal tolerance: .xxx ± 0.05mm (0.002").

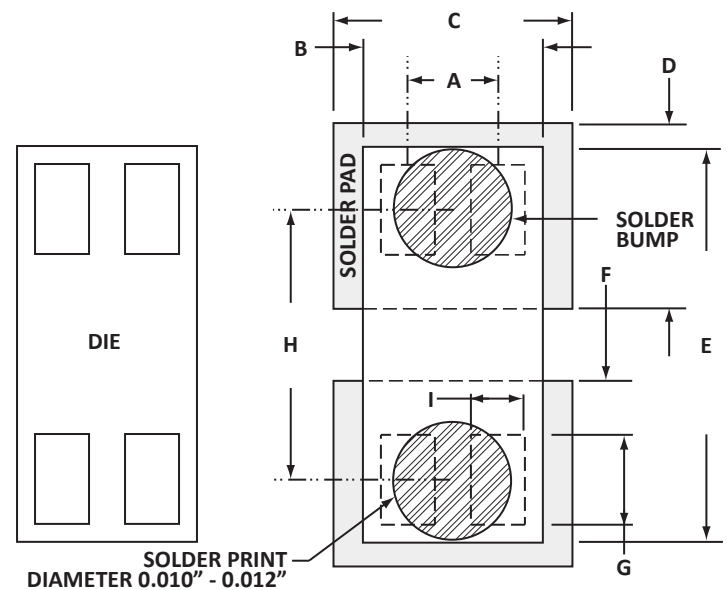

## TAPE AND REEL INFORMATION

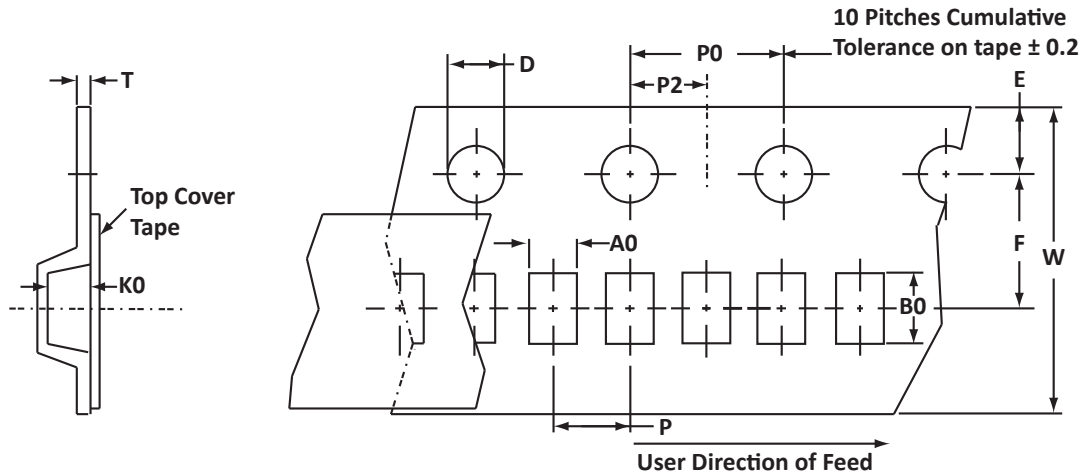

### SPECIFICATIONS

REEL DIA.	TAPE WIDTH	A0	B0	K0	D	E	F	W	P0	P2	P	Tmax
178(7")	8	0.70 ± 0.05	1.15 ± 0.10	0.56 ± 0.05	1.55 ± 0.05	1.75 ± 0.10	3.50 ± 0.05	8.00 ± 0.20	4.00 ± 0.05	2.00 ± 0.05	2.00 ± 0.05	0.25

#### NOTES

- Dimensions in millimeters.
- Top view of tape. Metal contacts are face down in tape package.
- Orientation: preferred stencil - 0.1mm (0.004").
- Surface mount product is taped and reeled in accordance with EIA 481.
- 8mm plastic tape: 7" Reels - 5,000 (pocket under hole skipped) pieces per reel.
- Marking on Reel - part number, date code and lot number.

#### TAPE & REEL ORIENTATION

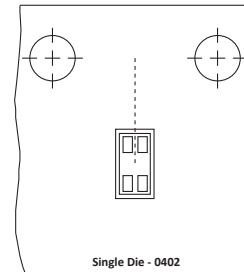

Package outline, pad layout and tape specifications per document number 06001.R7 8/12.

### ORDERING INFORMATION

BASE PART NUMBER (xx = Voltage)	LEADFREE SUFFIX	TAPE SUFFIX	QTY/REEL	REEL SIZE	TUBE QTY
LC0402FCxxC	-LF	-T75-1	5,000	7"	n/a

This device is only available in a Lead-Free configuration.



## COMPANY INFORMATION

---

### COMPANY PROFILE

In business more than 20 years, ProTek Devices™ is a privately-held company located in Tempe, Arizona, that offers a product line of transient voltage suppressors (TVS); avalanche breakdown diodes; steering diode TVS arrays and other surge suppressor component products. These TVS devices protect electronic systems from the effects of lightning, electrostatic discharge (ESD), nuclear electromagnetic pulses (NEMP), inductive switching and EMI / RFI. ProTek Devices also offers high performance interface and linear products that include analog switches; multiplexers; LED drivers; audio control ICs; RF and related high frequency products. The analog devices work in a host of consumer; industrial; automotive and other applications.

### CONTACT US

#### Corporate Headquarters

2929 South Fair Lane  
Tempe, Arizona 85282  
USA

#### By Telephone

General: 602-431-8101  
Sales & Marketing: 602-414-5109  
Customer Service: 602-414-5114  
Product Technical Support: 602-414-5107

#### By Fax

General: 602-431-2288

#### By E-mail:

Sales: [sales@protekdevices.com](mailto:sales@protekdevices.com)  
Customer Service: [service@protekdevices.com](mailto:service@protekdevices.com)  
Technical Support: [support@protekdevices.com](mailto:support@protekdevices.com)

#### ProTek Devices (Asia Pacific) Pte. Ltd.

8 Ubi Road 2, #06-19  
Zervex  
Singapore - 408538  
Tel: +65-67488312  
Fax: +65-67488313

#### Web

[www.protekdevices.com](http://www.protekdevices.com)

COPYRIGHT © ProTek Devices 2000 - This literature is subject to all applicable copyright laws and is not for resale in any manner.

SPECIFICATIONS: ProTek reserves the right to change the electrical and or mechanical characteristics described herein without notice.

DESIGN CHANGES: ProTek reserves the right to discontinue product lines without notice and that the final judgement concerning selection and specifications is the buyer's and that in furnishing engineering and technical assistance. ProTek assumes no responsibility with respect to the selection or specifications of such products. ProTek makes no warranty, representation or guarantee regarding the suitability of its products for any particular purpose, nor does ProTek assume any liability arising out of the application or use of any product or circuit and specifically disclaims any and all liability without limitation special, consequential or incidental damages.

LIFE SUPPORT POLICY: ProTek Devices products are not authorized for use in life support systems without written consent from the factory.

PATENT INFORMATION: This device is patented under U.S. Patent No. Des. "D456,367S".