

POWER MANAGEMENT

Description

The SC605 is a high-current charge pump designed specifically for use with white LEDs used in camera flash applications. Only two small bucket capacitors are required to develop the output drive, providing a low EMI solution compared to inductive boost regulators.

The SC605 has two modes of operation: Flash mode and Spotlight mode. In Flash mode, the SC605 is capable of delivering 500mA of regulated current for a duration of 500ms or up to 700mA for a reduced duration. In Spotlight mode the SC605 can output 20%, 30%, or 40% of the Flash mode current and remain enabled continuously.

An external resistor is connected in series with the LED to set the current. In Flash mode, this resistor can dissipate up to 0.175mW, reducing the power dissipation requirement of the SC605. The Flash input (FLASH) overrides the control inputs (CTRL0 and CTRL1) to ensure the Flash function has the highest priority.

The thermally efficient MLPD-12 package and ceramic bypass and bucket capacitors help make the SC605 a high output current driver that requires a minimal amount of PCB area.

Features

- ◆ Two selectable modes - Flash and Spotlight
- ◆ Up to 700mA output - Flash mode
- ◆ Up to 280mA output - Spotlight mode
- ◆ 500mA output over specified temperature and voltage ranges - Flash mode
- ◆ Spotlight mode selectable to 20%, 30% and 40% of Flash current
- ◆ 3.0V to 5.25V input range
- ◆ Flash control pin for synchronization to a camera module or graphics controller
- ◆ Short circuit, over-voltage and over-temperature protection
- ◆ Soft-start functionality
- ◆ Three control inputs for maximum versatility
- ◆ Shutdown current < 2µA
- ◆ Micro-lead package MLPD-12, 3mm x 3mm

Applications

- ◆ Mobile Camera Phones
- ◆ Digital Cameras
- ◆ PDAs with Built-in Cameras

Typical Application Circuit

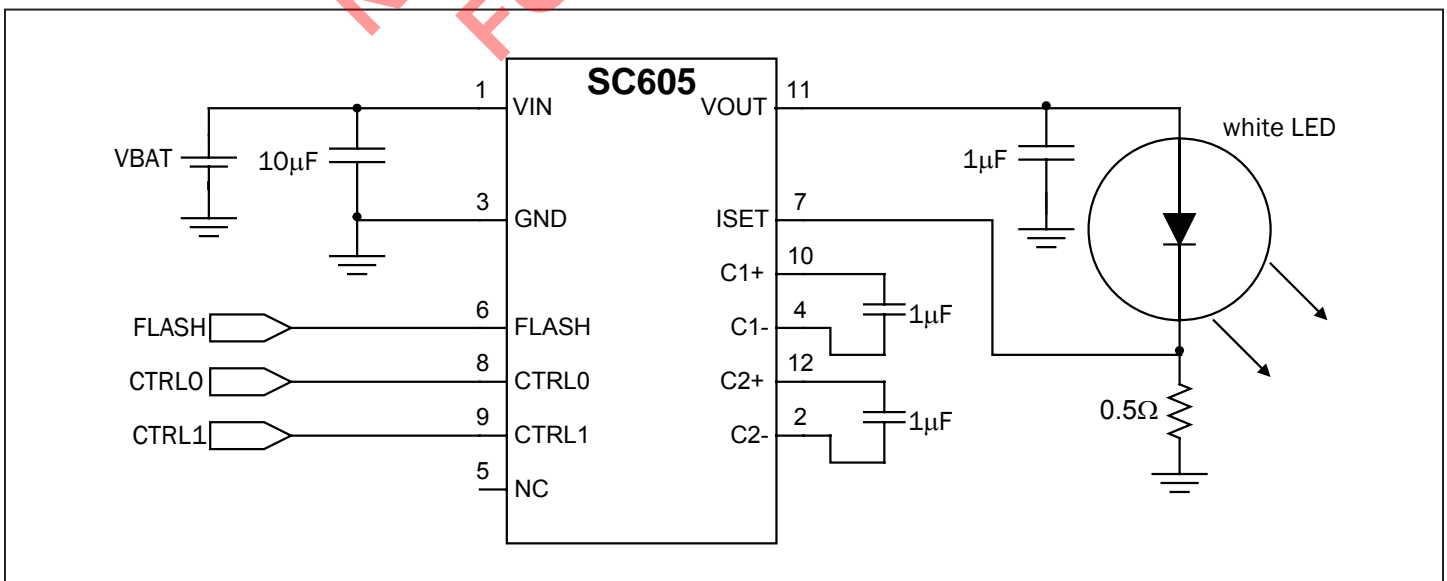

POWER MANAGEMENT

Absolute Maximum Ratings

Exceeding the specifications below may result in permanent damage to the device or device malfunction. Operation outside the parameters specified in the Electrical Characteristics section is not implied. Exposure to Absolute Maximum rated conditions for extended periods of time may affect device reliability.

Parameter	Symbol	Maximum	Units
Supply Voltage	V_{IN}	-0.3 to 6.5	V
Output Voltage	V_{OUT}	-0.3 to 6.5	V
Pin Voltage - FLASH, CTRL0, CTRL1, ISET, C1-, C2-		-0.3 to $V_{IN} + 0.3$	V
Pin Voltage - C1+, C2+		-0.3 to $V_{OUT} + 0.3$	V
V_{OUT} Short Circuit Duration	SC	Indefinite	
Thermal Resistance, Junction to Ambient (JESD51 Standard Method) ⁽¹⁾	θ_{JA}	40	°C/W
Operating Ambient Temperature Range	T_A	-40 to +85	°C
Junction Temperature Range	T_{JC}	-40 to +150	°C
Storage Temperature Range	T_{STG}	-65 to +150	°C
IR Reflow Temperature	T_{LEAD}	260	°C
ESD Protection Level ⁽²⁾	V_{ESD}	2	kV

Notes:

- 1) Calculated from package in still air, mounted to 3" x 4.5", 4 layer FR4 PCB with thermal vias under the exposed pad per JESD51 standards.
- 2) Tested according to JEDEC standard JESD22-A114-B

Electrical Characteristics

Unless otherwise specified: $T_A = 25^\circ\text{C}$ for TYP, -40°C to $+60^\circ\text{C}$ for MIN and MAX; $C_{IN} = 10\mu\text{F}$, $C_{BUCKET} = C_{OUT} = 1.0\mu\text{F}$ (ESR < 0.1 Ω); $V_{IN} = 3.0\text{V}$ to 5.25V ; $V_{OUT} = 2.8\text{V}$ to 4.25V ; $R_{ISET} = 0.5\Omega$ 0.1%.

Parameter	Symbol	Conditions	Min	Typ	Max	Units
Flash Mode - Output Current	I_{OUT}	FLASH high, $R_{ISET} = 0.357\Omega$, $3.7\text{V} < V_{IN} < 4.2\text{V}$, $V_{OUT} = 3.7\text{V}$ ⁽¹⁾		700		mA
		FLASH high, $R_{ISET} = 0.5\Omega$, $3.3\text{V} < V_{IN} < 4.2\text{V}$, $2.8\text{V} < V_{OUT} < 4.25\text{V}$	460	500	540	
		FLASH low, CTRL0 high, CTRL1 high, $R_{ISET} = 0.357\Omega$, $3.7\text{V} < V_{IN} < 4.2\text{V}$, $V_{OUT} = 3.4\text{V}$ ⁽¹⁾		280		
Spotlight Mode - Output Current	I_{OUT}	FLASH low, CTRL0 high, CTRL1 high, $R_{ISET} = 0.5\Omega$, $3.0\text{V} < V_{IN} < 4.5\text{V}$, $2.8\text{V} < V_{OUT} < 4.5\text{V}$	170	200	230	mA
		FLASH low, CTRL0 low, CTRL1 high, $R_{ISET} = 0.5\Omega$, $3.0\text{V} < V_{IN} < 4.5\text{V}$, $2.8\text{V} < V_{OUT} < 4.5\text{V}$	120	150	180 ⁽²⁾	
		FLASH low, CTRL0 high, CTRL1 low, $R_{ISET} = 0.5\Omega$, $3.0\text{V} < V_{IN} < 4.5\text{V}$, $2.8\text{V} < V_{OUT} < 4.5\text{V}$	70	100	130 ⁽²⁾	

POWER MANAGEMENT
Electrical Characteristics (Cont.)

Parameter	Symbol	Conditions	Min	Typ	Max	Units
Flash Mode - ISET Reference Voltage	V_{ISET}	FLASH high, $R_{ISET} = 0.5\Omega$, $3.3V < V_{IN} < 4.2V$, $2.8V < V_{OUT} < 4.25V$	230	250	270	
Spotlight Mode - ISET Reference Voltage	V_{ISET}	FLASH low, CTRL0 high, CTRL1 high $3.0V < V_{IN} < 4.5V$, $2.8V < V_{OUT} < 4.5V$	85	100	115	mV
		FLASH low, CTRL0 low, CTRL1 high $3.0V < V_{IN} < 4.5V$, $2.8V < V_{OUT} < 4.5V$	60	75	90 ⁽³⁾	
		FLASH low, CTRL0 high, CTRL1 low $3.0V < V_{IN} < 4.5V$, $2.8V < V_{OUT} < 4.5V$	35	50	65 ⁽³⁾	
Quiescent Current	I_Q	FLASH High		3.4	5	mA
		FLASH low, CTRL0 and/or CTRL1 High		2.0	4.5	mA
		FLASH low, CTRL0 low, CTRL1 Low		0.1	2	μ A
Flash Mode Pulse Duration ⁽⁴⁾	t_{FLASH}	$3.3V < V_{IN} < 4.2V$ $I_{OUT} = 500mA$			500	ms
Flash Mode Start-Up Time ⁽⁴⁾	t_{F-ST}	from $t = 0$ when FLASH goes high to $I_{OUT} = 90%$ of final value			1	ms
Spotlight Mode Start-Up Time ⁽⁴⁾	t_{S-ST}	from $t = 0$ when CTRL0 and/or CTRL1 transition high to $I_{OUT} = 90%$ of final value			1	ms
Oscillator Frequency	f_{OSC}	Device Enabled		250		kHz
Oscillator Frequency Accuracy	Δf_{OSC}		-15		15	%
Short-Circuit Output Current Limit	I_{SC}	$V_{OUT} = 0V$			465	mA
Input Current Limit	I_{LIMIT}	$3.3V < V_{IN} < 4.2V$			2.1	A
		$V_{IN} = 3.7V$, $V_{OUT} = 3.7V$, $T_A = 25^\circ C$	1.38	1.53		
Over-Temperature Protection ⁽⁴⁾	T_{OT}		150			$^\circ C$
		Hysteresis	10			$^\circ C$
Logic Input High Threshold	V_{IH}	FLASH, CTRL0, CTRL1	1.5			V
Logic Input Low Threshold	V_{IL}	FLASH, CTRL0, CTRL1			0.4	V
Logic Input High Current	I_{IH}	FLASH, CTRL0, CTRL1	1	20	35	μ A
Logic Input Low Current	I_{IL}	FLASH, CTRL0, CTRL1		0.1	2	μ A
ISET Ripple Voltage ⁽⁴⁾	V_{PP}	Spotlight Mode, $I_{OUT} = 200mA$		25		mV
		Flash Mode, $I_{OUT} = 500mA$		100		

Notes:

(1) V_{OUT} required by the typical LED at this current.

(2) Values do not overlap with the next higher spotlight mode for any single device. Expect Spotlight Modes to be separated by about 50mA.

(3) Values do not overlap with the next higher spotlight mode for any single device. Expect Spotlight Modes to be separated by about 25mV.

(4) Guaranteed by design - not tested in production.

POWER MANAGEMENT

Pin Configuration

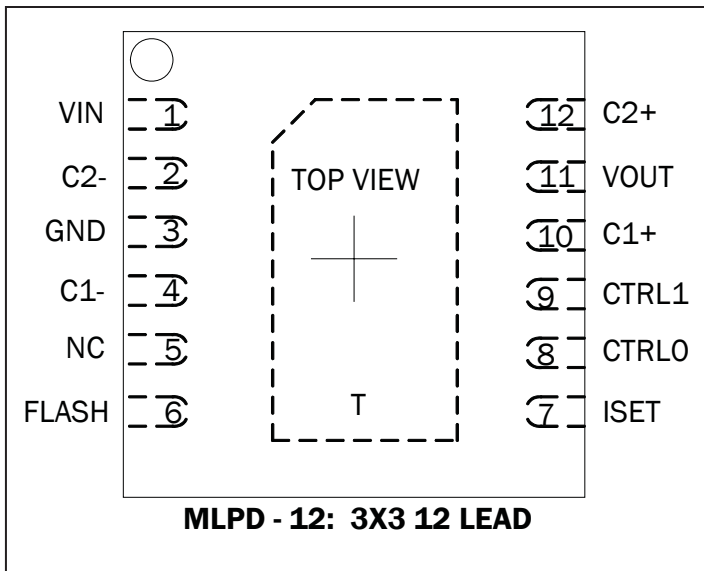

Ordering information

DEVICE	PACKAGE
SC605MLTRT ⁽¹⁾⁽²⁾	MLPD-12 3x3
SC605EVB	Evaluation Board

Notes:

- (1) Available in Tape and Reel only. A reel contains 3000 devices.
- (2) Available in lead-free package only. This product is fully WEEE and RoHS compliant.

Pin Descriptions

Pin	Pin Name	Pin Function (also see Suggested Layout guidelines on page 11)
1	VIN	Input voltage. Decouple with a 10 μ F or larger ceramic capacitor near pin 1.
2	C2-	Negative terminal of bucket capacitor 2 - use a 1 μ F ceramic capacitor.
3	GND	Ground - connect through multiple vias to the ground plane.
4	C1-	Negative terminal of bucket capacitor 1 - use a 1 μ F ceramic capacitor.
5	NC	Not connected - leave this pin floating.
6	FLASH	Flash mode enable pin - puts the device in active Flash mode when high.
7	ISET	Current-setting reference pin - connect to the LED cathode and the current setting resistor.
8	CTRL0	Control input bit 0 - used with CTRL1 to enable and set the output current in Spotlight mode (see Table 1).
9	CTRL1	Control input bit 1 - used with CTRL0 to enable and set the output current in Spotlight mode (see Table 1).
10	C1+	Positive terminal of bucket capacitor 1 - use a 1 μ F ceramic capacitor.
11	VOUT	Output pin - connect to LED anode. Decouple with a 1 μ F ceramic capacitor near pin 11.
12	C2+	Positive terminal of bucket capacitor 2 - use a 1 μ F ceramic capacitor.
T	Thermal Pad	Pad for heat sinking purposes - not connected internally. Connect to ground plane using multiple vias.

POWER MANAGEMENT

Applications Information

General Operation

The SC605 is a powerful 2x charge pump designed to drive a high-intensity white LED with a constant current (Spotlight mode) or with a pulsed current of higher intensity (Flash mode) used for camera flash.

In Flash mode the SC605 output can drive 500mA at 4.25V into an LED for up to 500ms. The FLASH pin is used to trigger Flash mode. In spotlight mode the SC605 regulates the output current to the value selected by the CTRL0 and CTRL1 inputs. Note that Flash mode has priority over Spotlight mode, i.e., the FLASH pin triggers Flash mode regardless of the state of the CTRL0 and CTRL1 pins.

Output current is regulated by attaching the ISET pin to the cathode(s) of the LED package and a load sense resistor (typically 0.5Ω). The ISET pin monitors the voltage at the cathode and signals the charge pump to increase or decrease the output current until the ISET voltage reaches the programmed setting. Programmed settings are shown in Table 1:

CTRL1	CTRL0	FLASH	V _{ISET}	Mode
0	0	0	0mV	Disabled
0	1	0	50mV	Spotlight
1	0	0	75mV	Spotlight
1	1	0	100mV	Spotlight
x	x	1	250mV	Flash

Table 1 - Control State Table

The resistor value is chosen to set the current through the LED based on this reference voltage. The resistor should not be less than 0.35Ω due to the output current limitations of the device. Note that the resistor sets both the Flash mode current and the Spotlight mode current.

In Flash mode, $I_{OUT} = V_{ISET} / R_{ISET} = 250mV / R_{ISET}$

In Spotlight mode, $I_{OUT} = V_{ISET} / R_{ISET}$

Spotlight Mode

Spotlight mode is enabled by setting the CTRL0 and CTRL1 pins as shown in Table 1. When in Spotlight mode,

the SC605 can maintain a constant current indefinitely to drive an LED or bank of LEDs. The ISET pin voltage is the reference V_{ISET} and has three different settings - 50mV, 75mV, and 100mV. These settings allow the designer the flexibility to select the output level needed to suit the application.

Flash Mode

Flash mode is enabled whenever the FLASH pin is pulled high and remains active until the FLASH pin is released. This mode has higher priority than Spotlight mode, so the state of the CTRL pin is overridden whenever the FLASH pin is activated. While in Flash mode the reference voltage on the ISET pin is set to 250mV. The duration of the pulse is limited by the amount of power that can be dissipated in the SC605 before it exceeds the maximum operating temperature. Note that if an output current less than the rated 500mA is desired, the duration of the pulse can increase proportionally.

Extending Flash mode beyond the 500ms pulse limit could adversely affect the long term reliability of the SC605. Flash duration must be derated at higher currents. For example, 700mA derates to a maximum of 350ms. In Flash mode, $I_{OUT} = 250mV / R_{ISET}$. The plot below shows maximum Flash mode current for extended duration times.

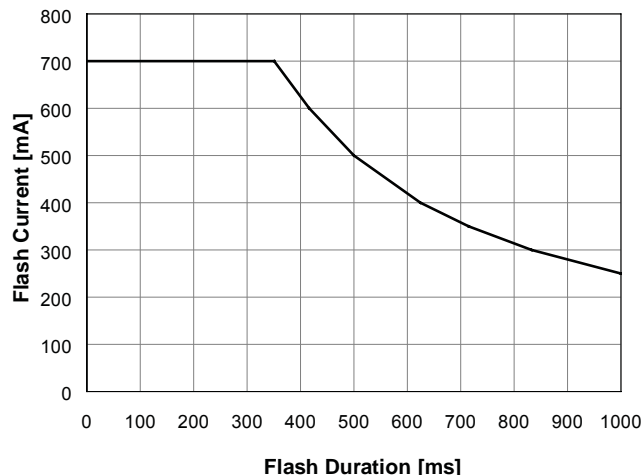

Maximum Flash Duration

POWER MANAGEMENT

Applications Information (Cont.)

Protection Circuitry

The SC605 also provides protection circuitry that prevents the device from operating in an unspecified state. These include Input Over-Voltage Protection (IOVP), Output Over-Voltage Protection (OVP), Over-Temperature Protection (OTP), Over-Current Protection (OCP), and Short-Circuit Current Protection (SCCP).

Input Over-Voltage Protection

Input over-voltage protection is included to prevent operation at high input voltages that could damage the device. The IOVP circuit senses the input voltage and determines when the supply exceeds 6V. When the voltage rises above this threshold, the device is disabled until the input voltage drops to a level within the specified input range. Hysteresis is included in this circuit to avoid chattering between states.

Output Over-Voltage Protection

Output over-voltage protection is included to prevent the SC605 from generating an output voltage that could damage other devices connected to it such as load LEDs and bypass capacitors. When the output voltage exceeds 5.5V, the OVP circuit disables the charge pump until the voltage decreases to a level within the acceptable range. This circuit allows the device to drive LEDs with high forward voltages at a reduced level without exceeding the output voltage limits specified for the device. This is a consequence of over-voltage protection, not the function of OVP.

Over-Temperature Protection

The OT circuit helps prevent the device from overheating and experiencing a catastrophic failure. When the junction temperature exceeds 150°C the device is disabled. It remains disabled until the junction temperature drops below this threshold. As with the OVP circuit, hysteresis is included to prevent toggling between states.

Over-Current Protection

When the SC605 is in 2X charge pump mode, the input current will be approximately double the required output. When the steady-state load requires the maximum current available in 2X mode, the OCP circuit prevents the device from overheating due to excessive power dissipation.

Short-Circuit Current Protection

SCCP is provided to limit the current that can be sourced when the output is shorted to ground. When the output voltage drops below 2V, the SCCP detects the condition as a short to ground and limits the output current.

Resistor Selection

The ISET resistor selection is critical to generating the correct current. The value can be chosen to set the Spotlight mode current or the Flash mode current, but it must be noted that the two current settings are dependent on the same resistor. It is recommended that the resistor be selected to match the LEDs desired current for Flash mode. This will allow the designer to set the maximum current out of the SC605. The typical application circuit shown on page 1 uses a 0.5Ω resistor to set a Flash mode current of 500mA and Spotlight mode options of 100mA, 150mA, and 200mA. A precision resistor should be used to ensure the specified accuracy for LED current.

To avoid malfunction of the charge pump, it is recommended that the resistance seen at the ISET pin remain constant while the device is active (Flash or Spotlight mode). Changing the resistance value or the load current while the device is active could cause instability or voltage transients that would result in non-compliant behavior. The load current return path is from the ISET sense point through the resistor and back to the ground pin. Resistance in this path adds to the total resistance and has the effect of reducing the LED current by about 4% per 10mV of DC drop across the return copper trace in Flash mode. For this reason, it is crucial to have a low resistance return path. Place and ground the resistor as close as possible to the ground pin of the SC605. The trace from ISET has virtually no current. The ISET trace should make contact at the pad of the power sense resistor to minimize the effect of voltage drop between the LED cathode and the resistor.

Capacitor Selection

The SC605 is designed to use low-ESR ceramic capacitors for the input and output bypass capacitors as well as the charge pump bucket capacitors. Ideal performance is achieved when C1 is exactly equal to C2. It is recommended that X5R or X7R ceramic capacitors be used for best performance.

POWER MANAGEMENT

Applications Information (Cont.)

Thermal Resistance

The SC605 package is thermally efficient when the circuit board layout connects the thermal pad through multiple vias to the ground plane. The thermal resistance is rated at 40 °C/W, but this rating is dependent on the connection between the thermal pad and the ground plane. A layout that is done correctly should keep the junction temperature below the OT limit while operating the SC605 within the specified electrical conditions for I_{OUT} and V_{ISET} . A poor layout may allow the junction temperature to reach the OT limit while in Flash or Spotlight mode.

NOT RECOMMENDED
FOR NEW DESIGN

POWER MANAGEMENT

Block Diagram

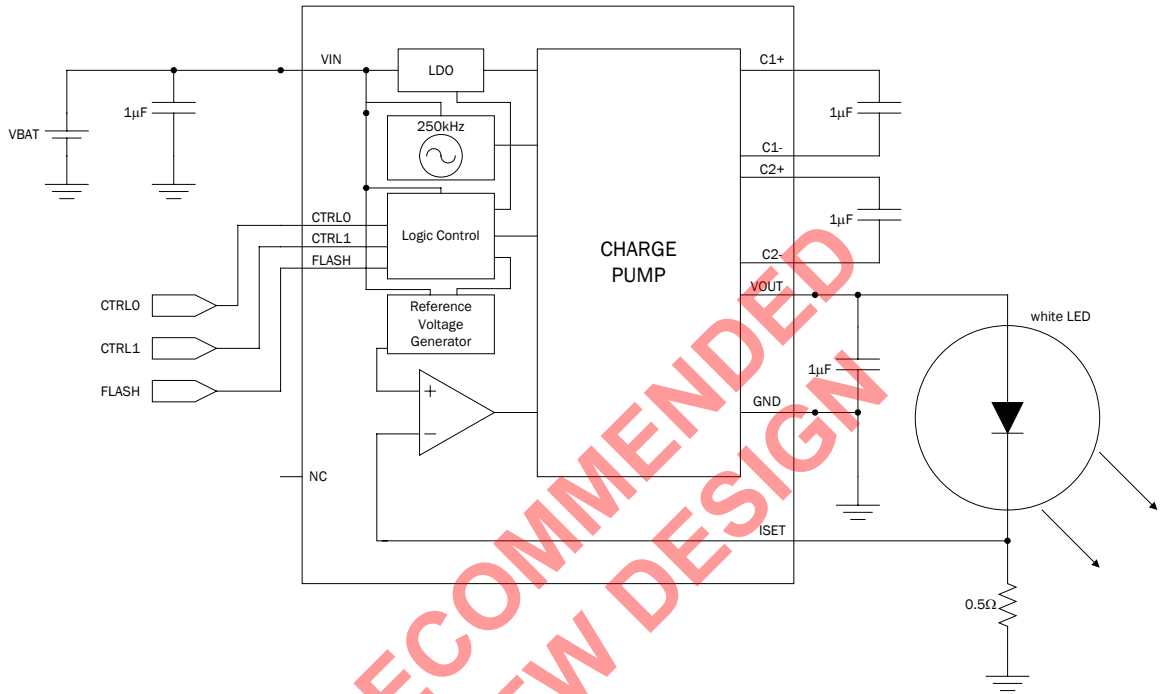
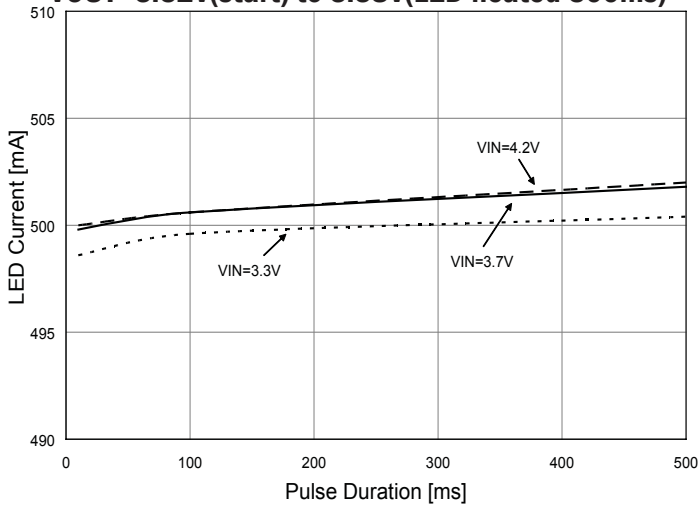

Figure 1 - SC605 Block Diagram with Support Components

POWER MANAGEMENT

Typical Characteristics

Flash Duration, R_{ISET}=500mΩ, V_{OUT}=3.52V(start) to 3.38V(LED heated 500ms)



Flash Current at 500ms, R_{ISET}= 500mΩ, V_{OUT}=3.38V

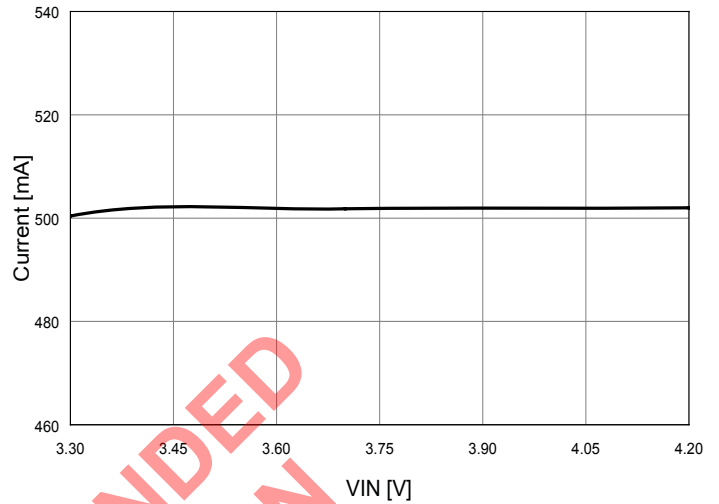

Flash Duration, R_{ISET}=350mΩ, V_{OUT}=3.62V (start) to 3.40V(LED heated 500ms)

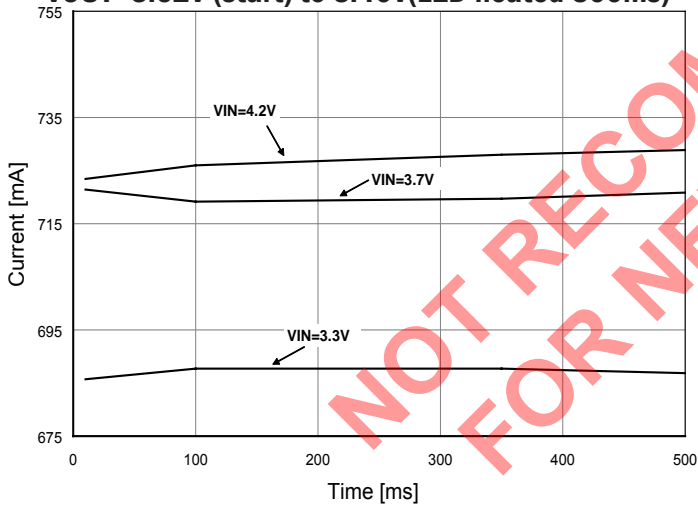

Flash Current at 100ms, R_{ISET}=500mΩ, V_{OUT}=3.46V

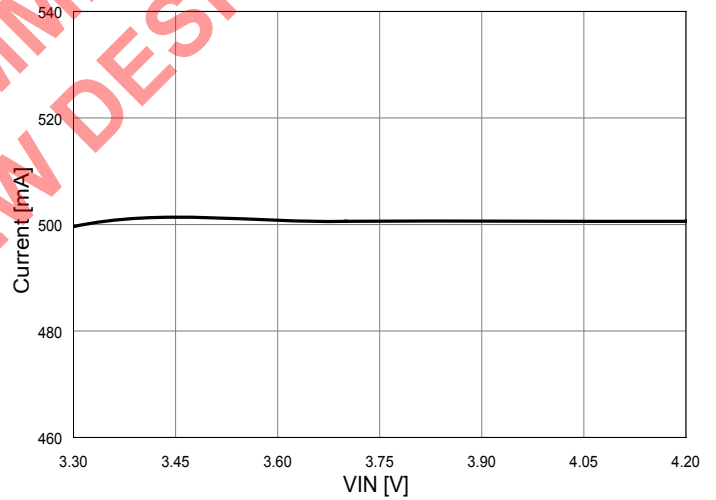

200mA Spotlight Current, R_{ISET}=500mΩ, V_{OUT}=3.0V

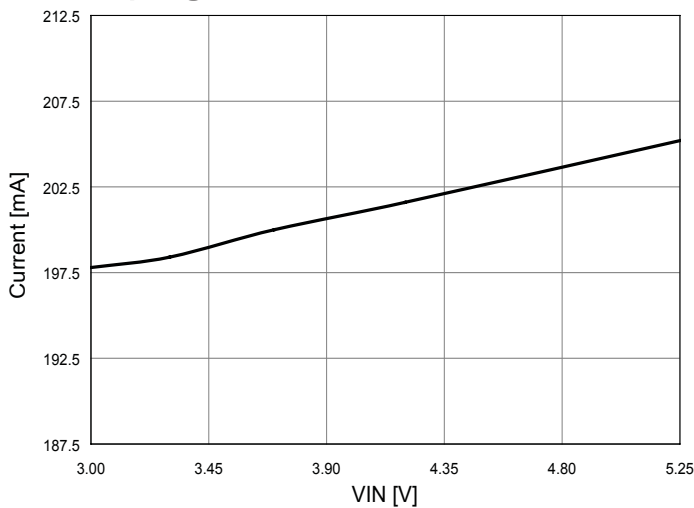

Flash Current at 10ms, R_{ISET}=500mΩ, V_{OUT}=3.52V

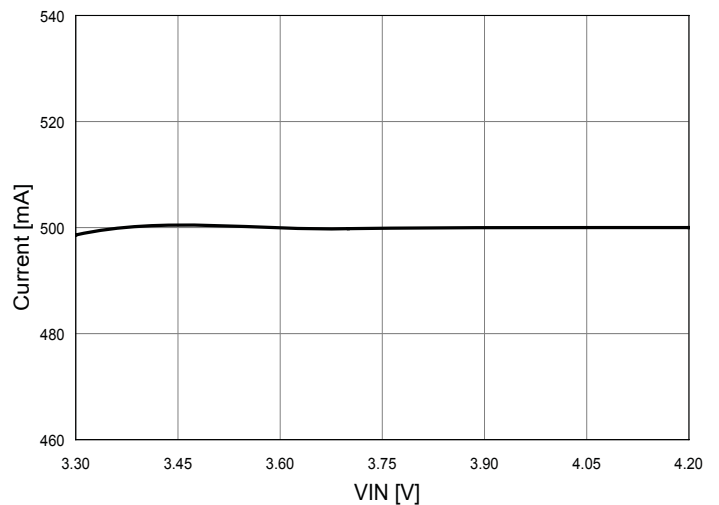

POWER MANAGEMENT

Typical Characteristics (Cont.)

Flash Current at 350ms, R_{ISET}=350mΩ, V_{OUT}=3.45V

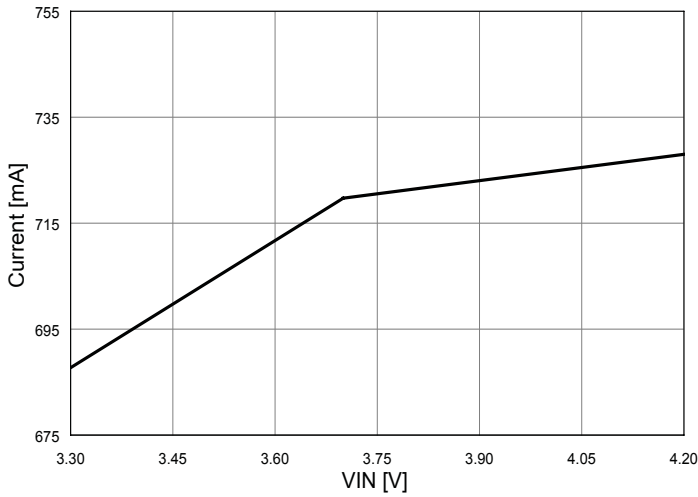

Flash Mode V_{ISET} Ripple

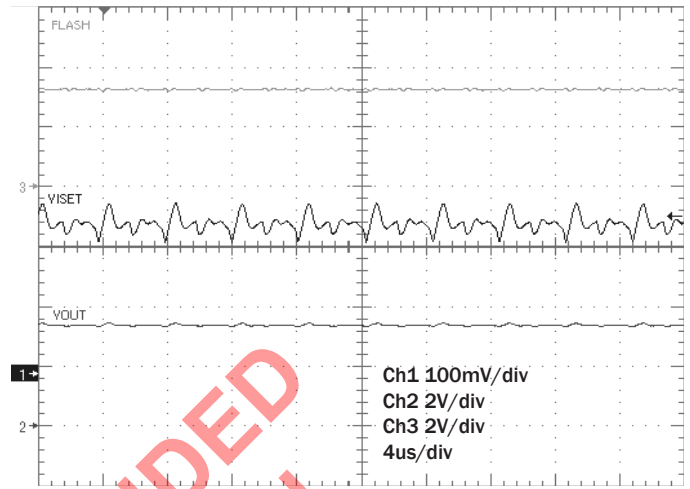

Flash Current at 100ms, R_{ISET}=350mΩ, V_{OUT}=3.53V

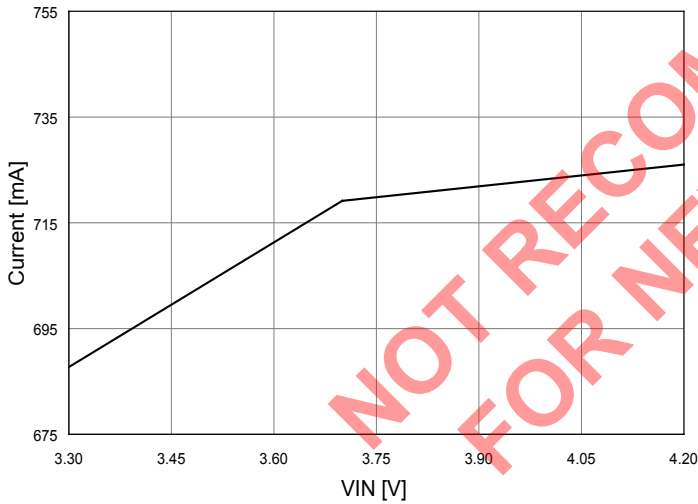

Startup Flash Mode 500mA

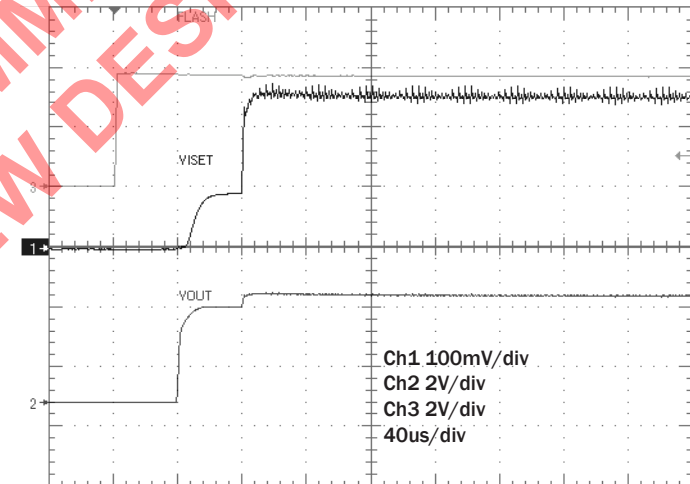

Flash Current at 10ms, R_{ISET}=350mΩ, V_{OUT}=3.62V

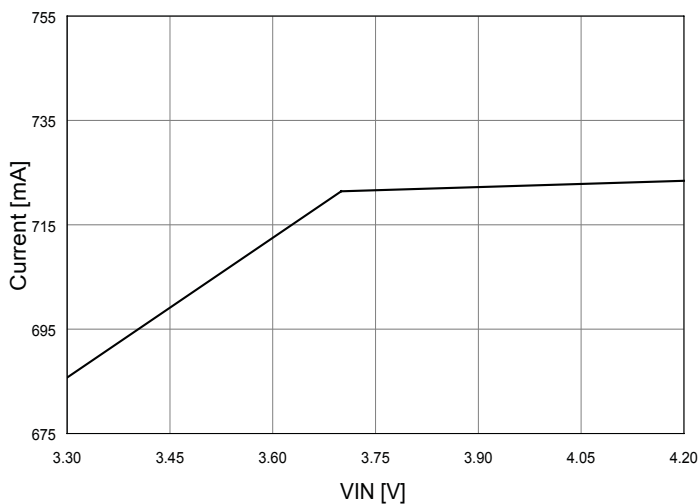

100mA Spotlight Current, R_{ISET}=500mΩ, V_{OUT}=2.92V

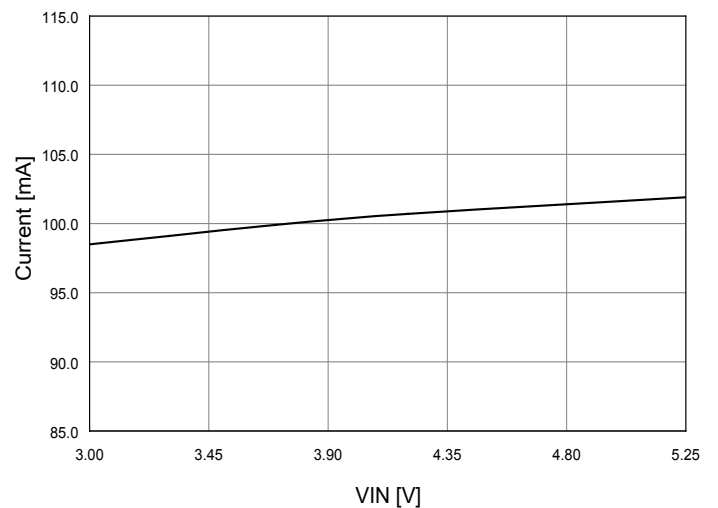

POWER MANAGEMENT

Suggested Layout

The following layout is suggested for a two layer design with one component side. The capacitors C1 and C2 are the bucket capacitors and each of these capacitors conducts the full load current of up to 700mA pulsed on for one half clock cycle per capacitor. C3 is the output decoupling capacitor, placed near the SC605. C4 is the input decoupling capacitor, placed near the SC605. Multiple vias should be used whenever it is necessary to change layers on nets connecting to pins VIN, VOUT, GND, C1-, C1+, C2-, C2+. Resistor R1 is routed with a very low resistance connection between ISET and GND pin 3. The sense trace between pin 7 and R1 is connected to R1 at the terminal pad for the most accurate sensing possible.

The bottom copper layer is primarily a ground plane providing a return path between the ground vias at R1 and the ground vias connecting pin 3 to the ground plane.

The SC605's center thermal pad is tied to the ground plane through a heat spreading copper shape with multiple vias. There are 10 vias shown in this layout connecting the thermal pad and pin 3 together to the ground plane. All 10 vias help spread heat and conduct ground current. Note that the thermal pad does not conduct current. Pin 3 conducts the full ground current.

Four signal traces routed on the bottom layer are CTRL1, CTRL0, FLASH and ISET. These traces are routed horizontally on the bottom layer. Carefully route these traces so they do not block the ground path from R1 to the ground pin 3.

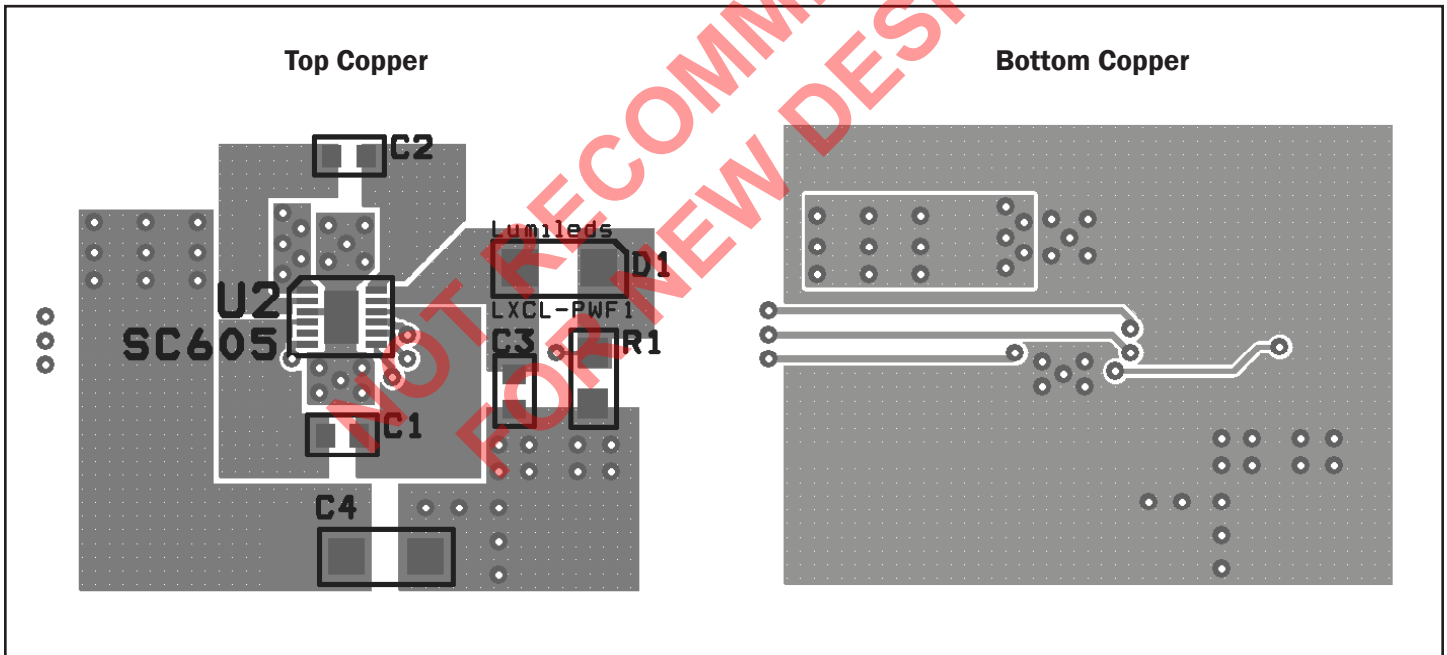

POWER MANAGEMENT

Outline Drawing - MLPD-12 Pin

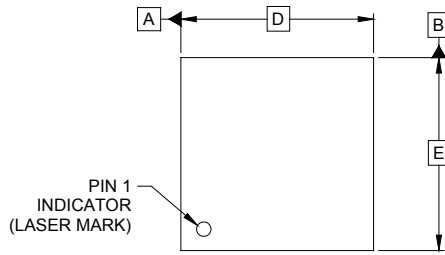

DIM	DIMENSIONS					
	INCHES			MILLIMETERS		
	MIN	NOM	MAX	MIN	NOM	MAX
A	.031	-	.039	0.80	-	1.00
A1	.000	-	.002	0.00	-	0.05
A2	(.008)			(0.20)		
b	.006	.008	.010	0.15	0.20	0.25
D	.114	.118	.122	2.90	3.00	3.10
D1	.074	.079	.083	1.87	2.02	2.12
E	.114	.118	.122	2.90	3.00	3.10
E1	.042	.048	.052	1.06	1.21	1.31
e	.018 BSC			0.45 BSC		
L	.012	.016	.020	0.30	0.40	0.50
N	12			12		
aaa	.003			0.08		
bbb	.004			0.10		

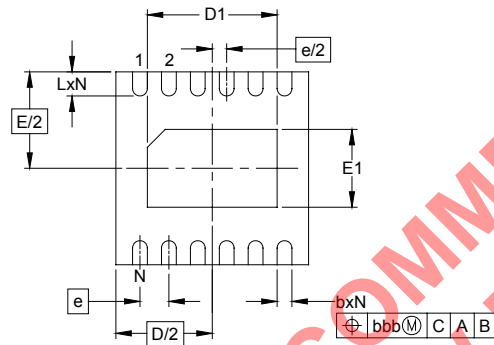
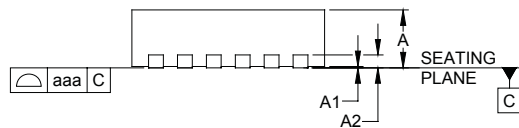

- NOTES:
1. CONTROLLING DIMENSIONS ARE IN MILLIMETERS (ANGLES IN DEGREES).
 2. COPLANARITY APPLIES TO THE EXPOSED PAD AS WELL AS TERMINALS.

Marking Information



yyww = Datecode
 xxxxx = Semtech lot number

POWER MANAGEMENT

Land Pattern - MLPD-12 Pin

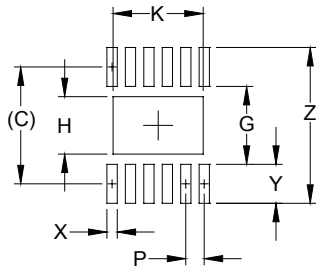

DIMENSIONS		
DIM	INCHES	MILLIMETERS
C	(.112)	(2.85)
G	.075	1.90
H	.055	1.40
K	.087	2.20
P	.018	0.45
X	.010	0.25
Y	.037	0.95
Z	.150	3.80

NOTES:

1. THIS LAND PATTERN IS FOR REFERENCE PURPOSES ONLY. CONSULT YOUR MANUFACTURING GROUP TO ENSURE YOUR COMPANY'S MANUFACTURING GUIDELINES ARE MET.
2. THERMAL VIAS IN THE LAND PATTERN OF THE EXPOSED PAD SHALL BE CONNECTED TO A SYSTEM GROUND PLANE. FAILURE TO DO SO MAY COMPROMISE THE THERMAL AND/OR FUNCTIONAL PERFORMANCE OF THE DEVICE.

NOT RECOMMENDED FOR NEW DESIGN

Contact Information

Taiwan Branch
Tel: 886-2-2748-3380
Fax: 886-2-2748-3390

Semtech Switzerland GmbH
Japan Branch
Tel: 81-3-6408-0950
Fax: 81-3-6408-0951

Korea Branch
Tel: 82-2-527-4377
Fax: 82-2-527-4376

Semtech Limited (U.K.)
Tel: 44-1794-527-600
Fax: 44-1794-527-601

Shanghai Office
Tel: 86-21-6391-0830
Fax: 86-21-6391-0831

Semtech France SARL
Tel: 33-(0)169-28-22-00
Fax: 33-(0)169-28-12-98

Semtech International AG is a wholly-owned subsidiary of Semtech Corporation, which has its headquarters in the U.S.A.

Semtech Germany GmbH
Tel: 49-(0)8161-140-123
Fax: 49-(0)8161-140-124

www.semtech.com