

# MJB6488, MJB6491

## Product Preview

# Complementary Silicon Plastic Power Transistors

... designed for use in general-purpose amplifier and switching applications.

- DC Current Gain Specified to 15 A –  
 $h_{FE} = 20 - 150 @ I_C = 5.0 \text{ Adc}$   
 $= 5.0 \text{ (Min) } @ I_C = 15 \text{ Adc}$
- Collector–Emitter Sustaining Voltage –  
 $V_{CEO(sus)} = 80 \text{ Vdc (Min)}$
- Epoxy Meets UL 94 V–0 @ 0.125 in
- ESD Ratings: Human Body Model; 3B, >8000 V,  
Machine Model; C, >400 V

### MAXIMUM RATINGS

Rating	Symbol	Value	Unit
Collector–Emitter Voltage	$V_{CEO}$	80	Vdc
Collector–Base Voltage	$V_{CB}$	90	Vdc
Emitter–Base Voltage	$V_{EB}$	5.0	Vdc
Collector Current – Continuous	$I_C$	15	Adc
Base Current	$I_B$	5.0	Adc
Total Power Dissipation @ $T_C = 25^\circ\text{C}$ Derate above $25^\circ\text{C}$	$P_D$	75 0.6	W W/ $^\circ\text{C}$
Total Power Dissipation @ $T_A = 25^\circ\text{C}$ Derate above $25^\circ\text{C}$	$P_D$	1.8 0.014	W W/ $^\circ\text{C}$
Operating and Storage Junction Temperature Range	$T_J, T_{stg}$	–65 to +150	$^\circ\text{C}$

### THERMAL CHARACTERISTICS

Characteristic	Symbol	Max	Unit
Thermal Resistance, Junction–to–Case	$R_{\theta JC}$	1.67	$^\circ\text{C/W}$
Thermal Resistance, Junction–to–Ambient	$R_{\theta JA}$	70	$^\circ\text{C/W}$

Maximum ratings are those values beyond which device damage can occur. Maximum ratings applied to the device are individual stress limit values (not normal operating conditions) and are not valid simultaneously. If these limits are exceeded, device functional operation is not implied, damage may occur and reliability may be affected.

This document contains information on a product under development. ON Semiconductor reserves the right to change or discontinue this product without notice.



**ON Semiconductor®**

<http://onsemi.com>

## 15 A COMPLEMENTARY SILICON POWER TRANSISTORS 80 V, 75 W

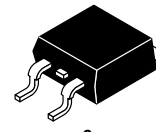

**D<sup>2</sup>PAK  
CASE 418B  
STYLE 1**

### MARKING DIAGRAM

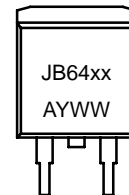

xx = 88 or 91  
A = Assembly Location  
Y = Year  
WW = Work Week

### ORDERING INFORMATION

Device	Package	Shipping†
MJB6488	D <sup>2</sup> PAK	50 Units / Rail
MJB6488T4	D <sup>2</sup> PAK	800 / Tape & Reel
MJB6491	D <sup>2</sup> PAK	50 Units / Rail
MJB6491T4	D <sup>2</sup> PAK	800 / Tape & Reel

†For information on tape and reel specifications, including part orientation and tape sizes, please refer to our Tape and Reel Packaging Specifications Brochure, BRD8011/D.

# MJB6488, MJB6491

## ELECTRICAL CHARACTERISTICS (T<sub>C</sub> = 25°C unless otherwise noted)

Characteristic	Symbol	Min	Max	Unit	
<b>OFF CHARACTERISTICS</b>					
Collector-Emitter Sustaining Voltage (Note 1)	(I <sub>C</sub> = 200 mAdc, I <sub>B</sub> = 0)	V <sub>CEO(sus)</sub>	80	-	Vdc
Collector-Emitter Sustaining Voltage (Note 1)	(I <sub>C</sub> = 200 mAdc, V <sub>BE</sub> = 1.5 Vdc)	V <sub>CEX</sub>	90	-	Vdc
Collector Cutoff Current	(V <sub>CE</sub> = 40 Vdc, I <sub>B</sub> = 0)	I <sub>CEO</sub>	-	1.0	mAdc
Collector Cutoff Current	(V <sub>CE</sub> = 85 Vdc, V <sub>EB(off)</sub> = 1.5 Vdc) (V <sub>CE</sub> = 80 Vdc, V <sub>EB(off)</sub> = 1.5 Vdc, T <sub>C</sub> = 150°C)	I <sub>CEx</sub>	-	100 5.0	μAdc mAdc
Emitter Cutoff Current	(V <sub>BE</sub> = 5.0 Vdc, I <sub>C</sub> = 0)	I <sub>EBO</sub>	-	10	μA

<b>ON CHARACTERISTICS</b>					
DC Current Gain	(I <sub>C</sub> = 5.0 Adc, V <sub>CE</sub> = 4.0 Vdc) (I <sub>C</sub> = 15 Adc, V <sub>CE</sub> = 4.0 Vdc)	h <sub>FE</sub>	20 5.0	150 -	-
Collector-Emitter Saturation Voltage	(I <sub>C</sub> = 5.0 Adc, I <sub>B</sub> = 0.5 Adc) (I <sub>C</sub> = 15 Adc, I <sub>B</sub> = 5.0 Adc)	V <sub>CE(sat)</sub>	-	1.3 3.5	Vdc
Base-Emitter On Voltage	(I <sub>C</sub> = 5.0 Adc, V <sub>CE</sub> = 4.0 Vdc) (I <sub>C</sub> = 15 Adc, V <sub>CE</sub> = 4.0 Vdc)	V <sub>BE(on)</sub>	-	1.3 3.5	Vdc

<b>DYNAMIC CHARACTERISTICS</b>					
Current-Gain - Bandwidth Product (Note 2)	(I <sub>C</sub> = 1.0 Adc, V <sub>CE</sub> = 4.0 Vdc, f <sub>test</sub> = 1.0 MHz)	f <sub>T</sub>	5.0	-	MHz
Small-Signal Current Gain	(I <sub>C</sub> = 1.0 Adc, V <sub>CE</sub> = 4.0 Vdc, f = 1.0 kHz)	h <sub>fe</sub>	25	-	-

1. Pulse Test: Pulse Width ≤ 300 μs, Duty Cycle ≤ 2.0%.
2. f<sub>T</sub> = |h<sub>fe</sub>| • f<sub>test</sub>.

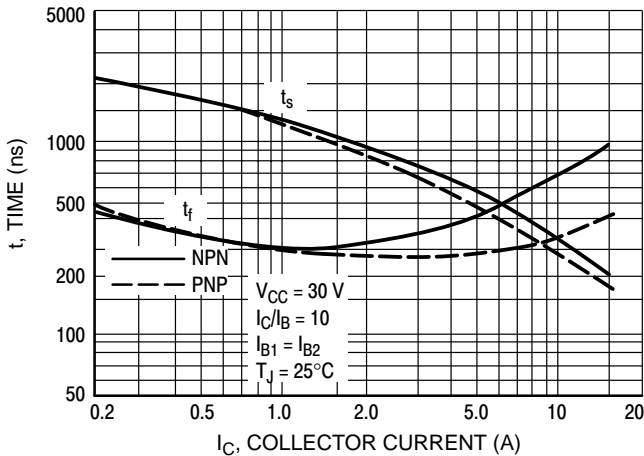

Figure 1. Turn-Off Time

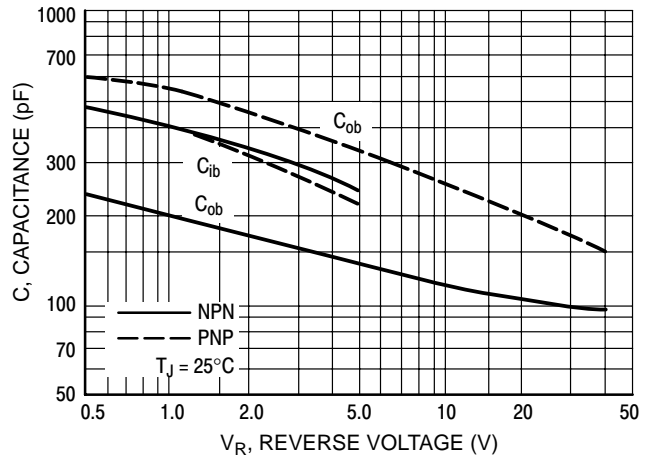

Figure 2. Capacitances

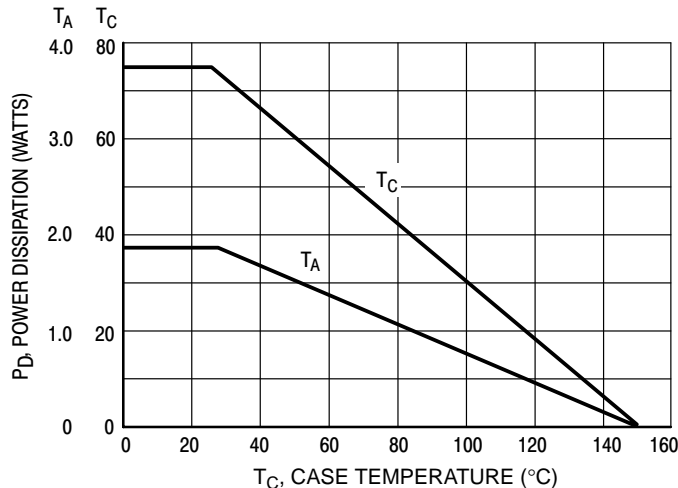

Figure 3. Power Derating

# MJB6488, MJB6491

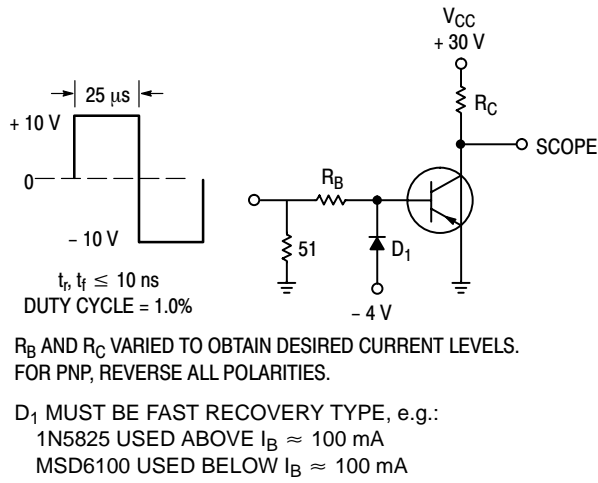

Figure 4. Switching Time Test Circuit

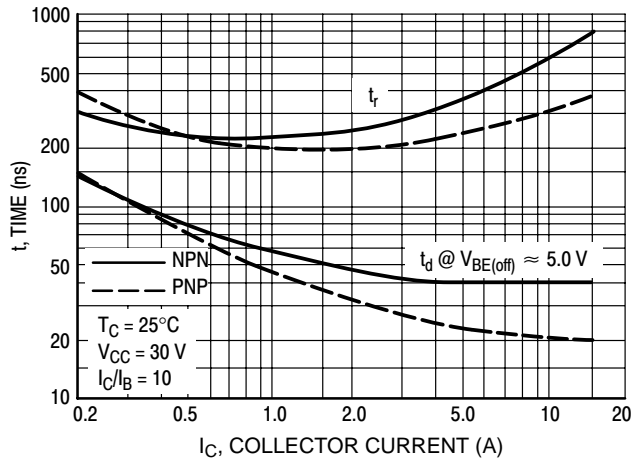

Figure 5. Turn-On Time

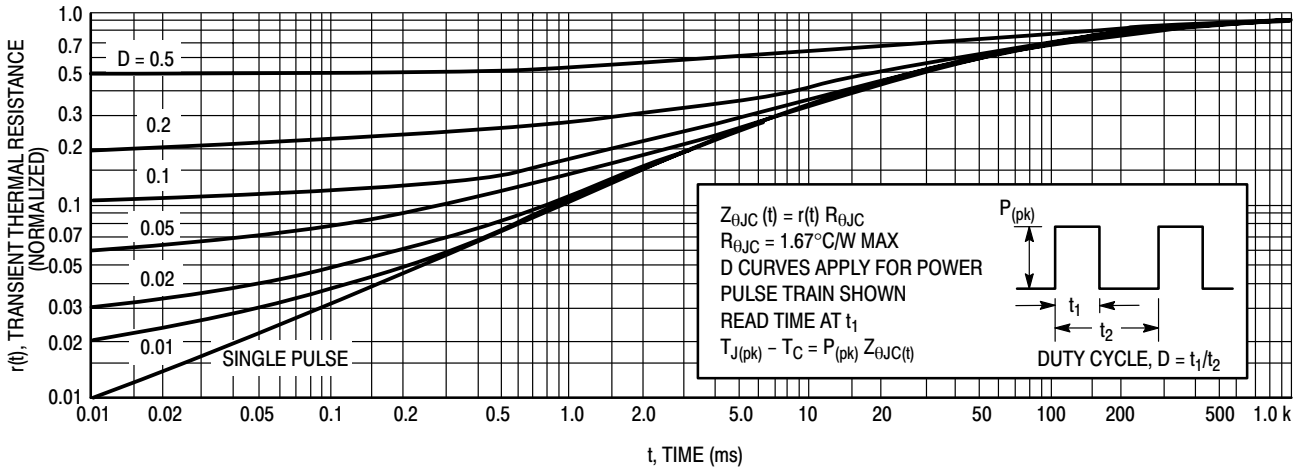

Figure 6. Thermal Response

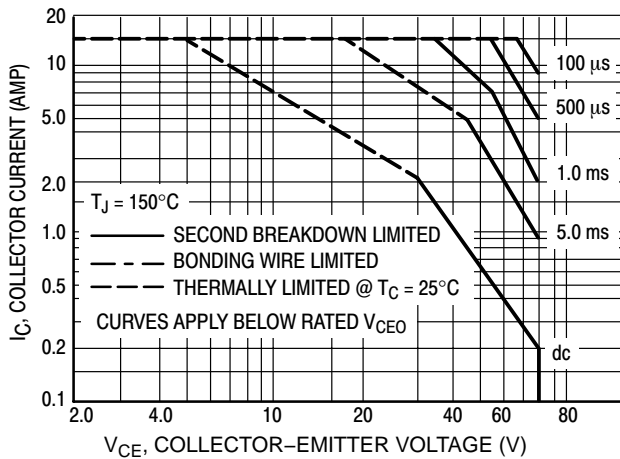

Figure 7. Active-Region Safe Operating Area

There are two limitations on the power handling ability of a transistors average junction temperature and second breakdown. Safe operating area curves indicate  $I_C - V_{CE}$  limits of the transistor that must be observed for reliable operation; i.e., the transistor must not be subjected to greater dissipation than the curves indicate.

The data of Figure 7 is based on  $T_{J(pk)} = 150^\circ\text{C}$ ;  $T_C$  is variable depending on conditions. Second breakdown pulse limits are valid for duty cycles to 10% provided  $T_{J(pk)} \leq 150^\circ\text{C}$ .  $T_{J(pk)}$  may be calculated from the data in Figure 6. At high case temperatures, thermal limitations will reduce the power that can be handled to values less than the limitations imposed by second breakdown

# MJB6488, MJB6491

NPN – MJB6488

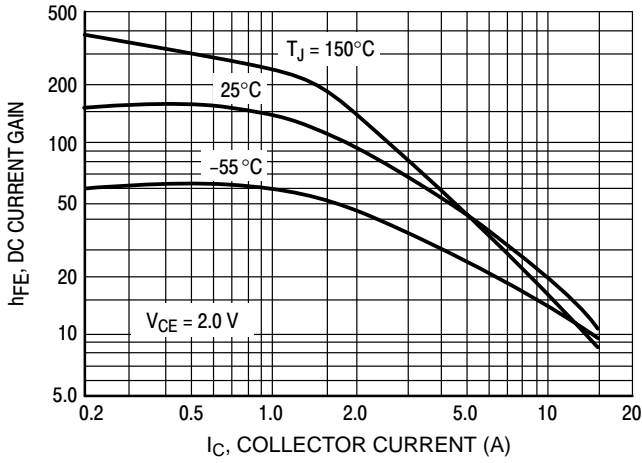

PNP – MJB6491

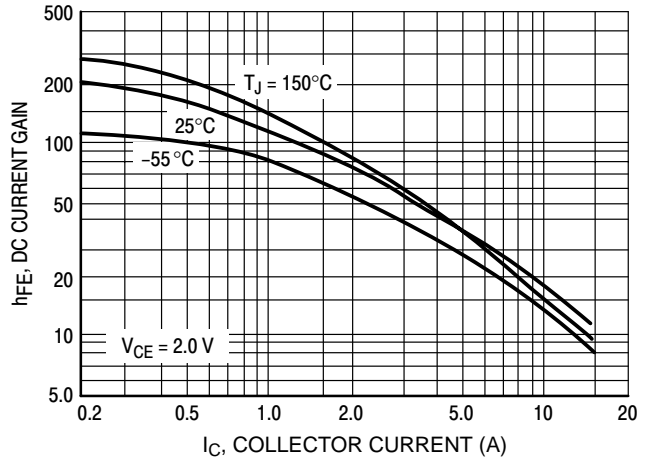

Figure 8. DC Current Gain

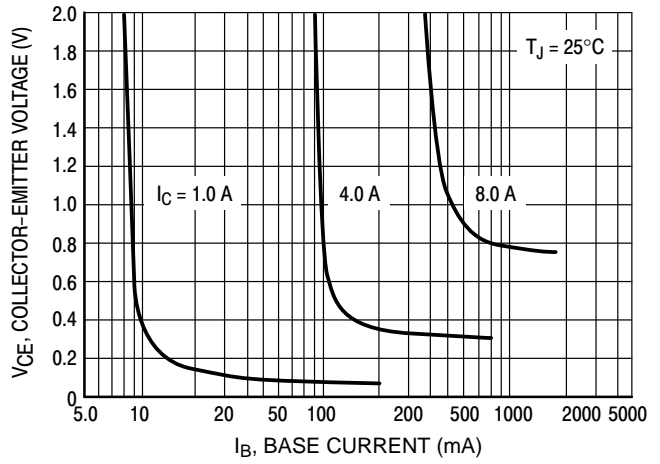
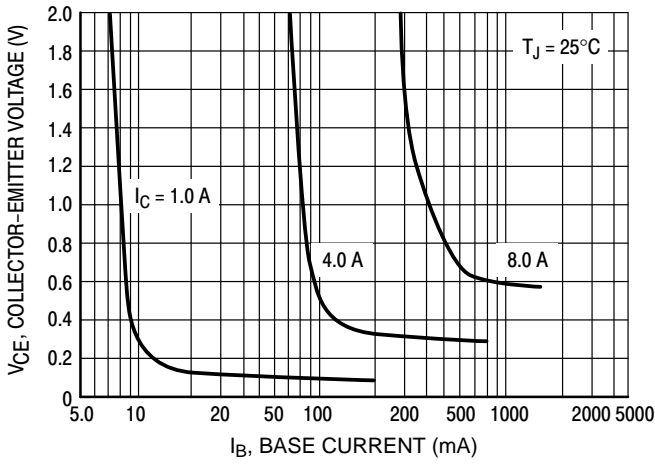

Figure 9. Collector Saturation Region

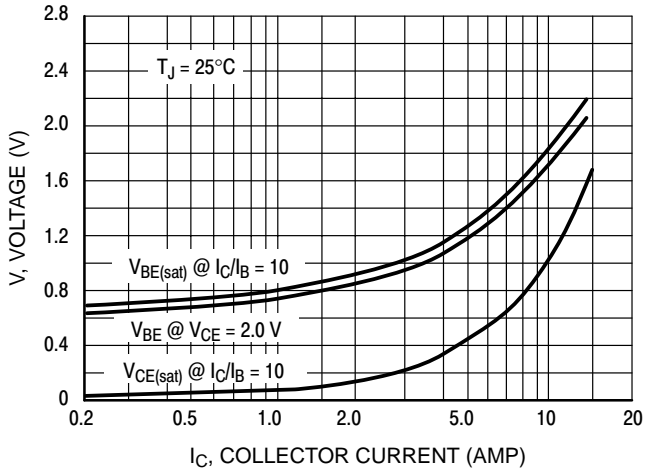
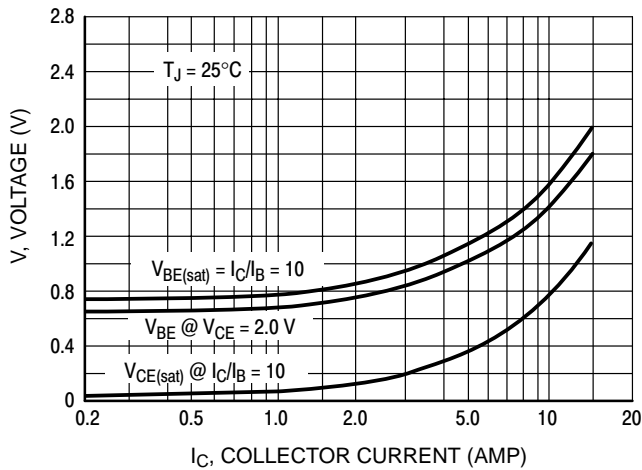
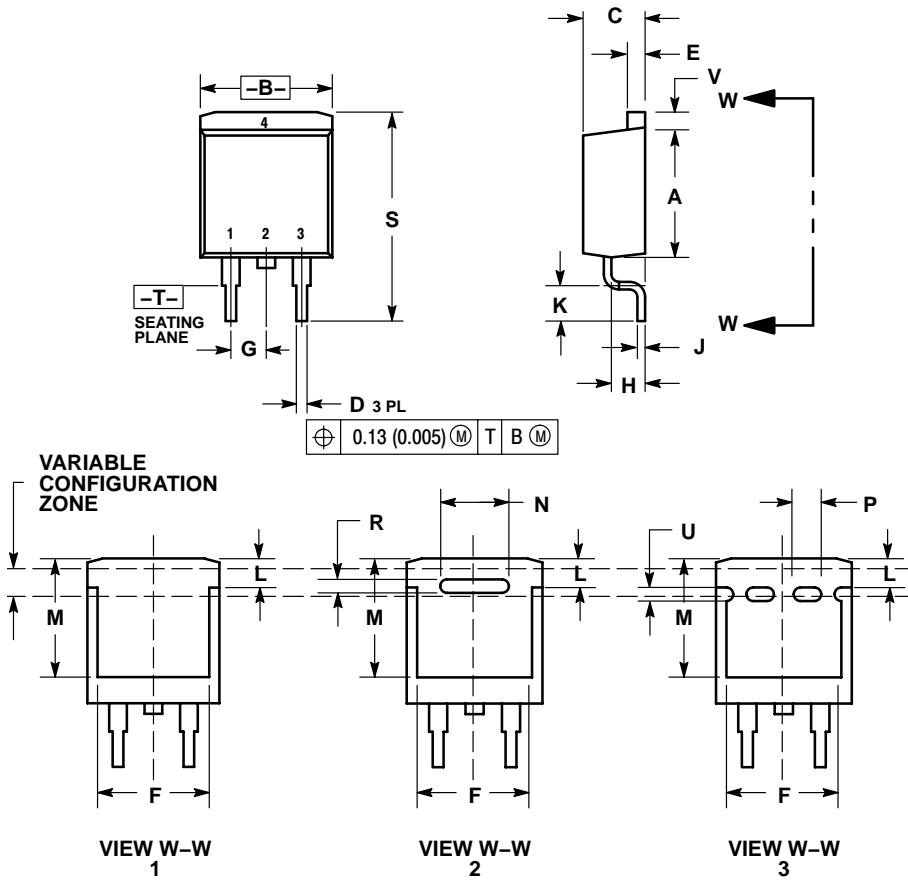

Figure 10. "On" Voltages

# MJB6488, MJB6491

## PACKAGE DIMENSIONS

### D<sup>2</sup>PAK CASE 418B-04 ISSUE H



#### NOTES:

1. DIMENSIONING AND TOLERANCING PER ANSI Y14.5M, 1982.
2. CONTROLLING DIMENSION: INCH.
3. 418B-01 THRU 418B-03 OBSOLETE, NEW STANDARD 418B-04.

DIM	INCHES		MILLIMETERS	
	MIN	MAX	MIN	MAX
A	0.340	0.380	8.64	9.65
B	0.380	0.405	9.65	10.29
C	0.160	0.190	4.06	4.83
D	0.020	0.035	0.51	0.89
E	0.045	0.055	1.14	1.40
F	0.310	0.350	7.87	8.89
G	0.100 BSC		2.54 BSC	
H	0.080	0.110	2.03	2.79
J	0.018	0.025	0.46	0.64
K	0.090	0.110	2.29	2.79
L	0.052	0.072	1.32	1.83
M	0.280	0.320	7.11	8.13
N	0.197 REF		5.00 REF	
P	0.079 REF		2.00 REF	
R	0.039 REF		0.99 REF	
S	0.575	0.625	14.60	15.88
V	0.045	0.055	1.14	1.40

#### STYLE 1:

- PIN 1. BASE
2. COLLECTOR
3. EMITTER
4. COLLECTOR

### SOLDERING FOOTPRINT

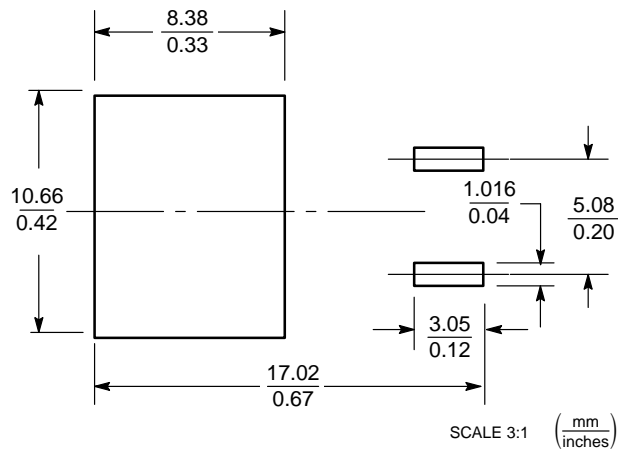

**ON Semiconductor** and  are registered trademarks of Semiconductor Components Industries, LLC (SCILLC). SCILLC reserves the right to make changes without further notice to any products herein. SCILLC makes no warranty, representation or guarantee regarding the suitability of its products for any particular purpose, nor does SCILLC assume any liability arising out of the application or use of any product or circuit, and specifically disclaims any and all liability, including without limitation special, consequential or incidental damages. "Typical" parameters which may be provided in SCILLC data sheets and/or specifications can and do vary in different applications and actual performance may vary over time. All operating parameters, including "Typicals" must be validated for each customer application by customer's technical experts. SCILLC does not convey any license under its patent rights nor the rights of others. SCILLC products are not designed, intended, or authorized for use as components in systems intended for surgical implant into the body, or other applications intended to support or sustain life, or for any other application in which the failure of the SCILLC product could create a situation where personal injury or death may occur. Should Buyer purchase or use SCILLC products for any such unintended or unauthorized application, Buyer shall indemnify and hold SCILLC and its officers, employees, subsidiaries, affiliates, and distributors harmless against all claims, costs, damages, and expenses, and reasonable attorney fees arising out of, directly or indirectly, any claim of personal injury or death associated with such unintended or unauthorized use, even if such claim alleges that SCILLC was negligent regarding the design or manufacture of the part. SCILLC is an Equal Opportunity/Affirmative Action Employer. This literature is subject to all applicable copyright laws and is not for resale in any manner.

## PUBLICATION ORDERING INFORMATION

### LITERATURE FULFILLMENT:

Literature Distribution Center for ON Semiconductor  
P.O. Box 61312, Phoenix, Arizona 85082-1312 USA  
**Phone:** 480-829-7710 or 800-344-3860 Toll Free USA/Canada  
**Fax:** 480-829-7709 or 800-344-3867 Toll Free USA/Canada  
**Email:** orderlit@onsemi.com

**N. American Technical Support:** 800-282-9855 Toll Free  
USA/Canada

**Japan:** ON Semiconductor, Japan Customer Focus Center  
2-9-1 Kamimeguro, Meguro-ku, Tokyo, Japan 153-0051  
**Phone:** 81-3-5773-3850

**ON Semiconductor Website:** <http://onsemi.com>

**Order Literature:** <http://www.onsemi.com/litorder>

For additional information, please contact your  
local Sales Representative.