



1.0 Amp. Surface Mount Schottky Barrier Rectifiers

<p>DO-214AA (SMB)</p> 	<p>Voltage 20 V to 150 V</p> <p>Current 1.0 A</p>
<p>FEATURES</p> <ul style="list-style-type: none"> Low profile package Ideal for automated placement Low power losses, high efficiency High surge current capability Guarding for overvoltage protection Low forward voltage drop Solder dip 260°C, 10s AEC-Q101 qualified Component in accordance to RoHS 2011/65/EU and WEEE 2002/96/EC Meets MSL level 1, per J-STD-020, LF maximum peak of 260° C 	
  RoHS COMPLIANT	
<p>MECHANICAL DATA</p> <ul style="list-style-type: none"> Case: DO-214AA (SMB). Epoxy meets UL 94V-0 flammability rating. Polarity: Color band denotes cathode end. Terminals: Matte tin plated leads, solderable per MIL-STD-750 Method 2026, J-STD-002 and JESD22-B102. Consumer grade, meets JESD 201 class 1A whisker test 	
<p>TYPICAL APPLICATIONS</p> <p>Used in low voltage high frequency inverters, freewheeling, dc-to-dc converters, and polarity protection applications.</p>	

Maximum Ratings and Electrical Characteristics at 25 °C

		SK 12B	SK 13B	SK 14B	SK 15B	SK 16B	SK 19B	SK 110B	SK 115B	
Marking code		I1	I2	I3	I4	I5	I6	I7	I8	
V_{RRM}	Maximum Recurrent Peak Reverse Voltage (V)	20	30	40	50	60	90	100	150	
V_{RMS}	Maximum RMS Voltage (V)	14	21	28	35	42	63	70	105	
V_{DC}	Maximum DC Blocking Voltage (V)	20	30	40	50	60	90	100	150	
$I_{F(AV)}$	Maximum Average Forward Rectified Current at T_L (See graphic)	1.0 A								
I_{FSM}	8.3 ms. Peak Forward Surge Current (Jedec Method)	30 A								
T_j	Operating Temperature Range	-55°C to +125°C			-55°C to +150°C					
T_{stg}	Storage Temperature Range	-55°C to +150°C								

Electrical Characteristics at $T_{amb} = 25\text{ °C}$

V_F	Maximum Instantaneous Forward Voltage @ 1.0 A	0.5 V	0.75 V	0.85 V	0.95 V
I_R	Maximum DC Reverse Current (Note 1) $T_A = 25\text{ °C}$	0.5 mA			0.1 mA
	at Rated DC Blocking Voltage $T_A = 100\text{ °C}$	10 mA	5.0 mA	--	
	$T_A = 125\text{ °C}$	--			2.0 mA
C_j	Typical Junction Capacitance (Note 2)	110 pF			
R_{thj-l}	Typical Thermal Resistance (Note 3)	25 °C/W			

NOTES: 1. Pulse Test With PW = 300 µsec, 1% Duty Cycle
 2. Measured at 1 MHz and Applied Reverse Voltage of 4.0 V D.C.
 3. Measured on P.C. Board with 10mm x10mm Copper Pad Areas

1.0 Amp. Surface Mount Schottky Barrier Rectifiers

Ordering information

PREFERRED P/N	PACKAGE CODE	DELIVERY MODE	BASE QUANTITY	UNIT WEIGHT (g)
SK110B TRTB	TRTB	13" diameter tape and reel	3,000	0.0823
SK110B TRTS	TRTS	7" diameter tape and reel	850	0.0823

Package Outline Dimensions: (mm) DO-214AA (SMB)

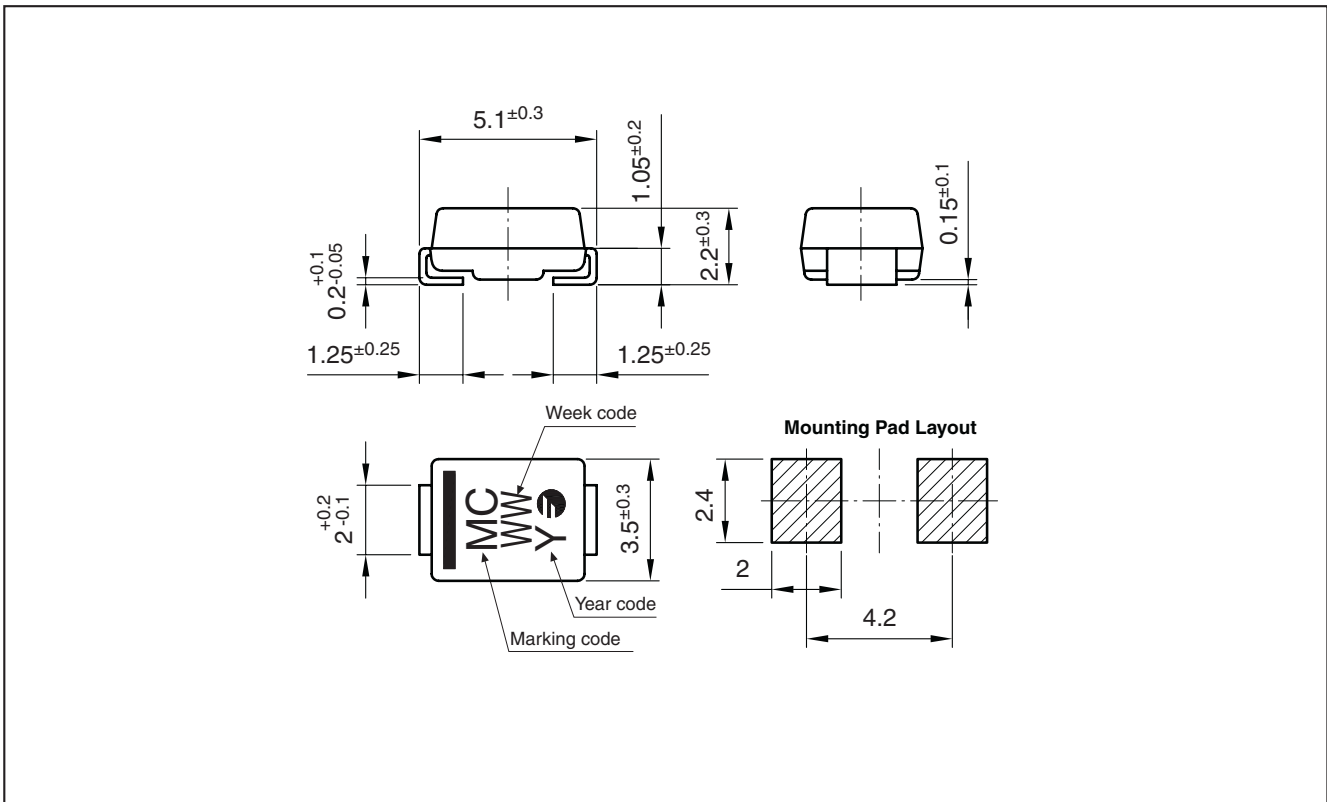

1.0 Amp. Surface Mount Schottky Barrier Rectifiers

Ratings and Characteristics (Ta 25 °C unless otherwise noted)

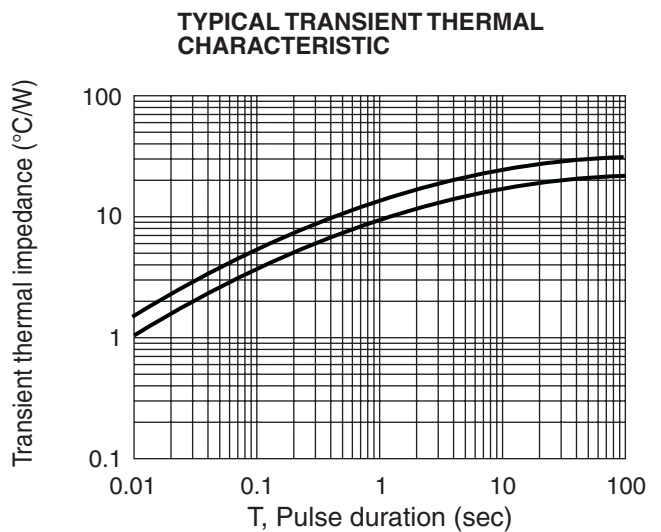
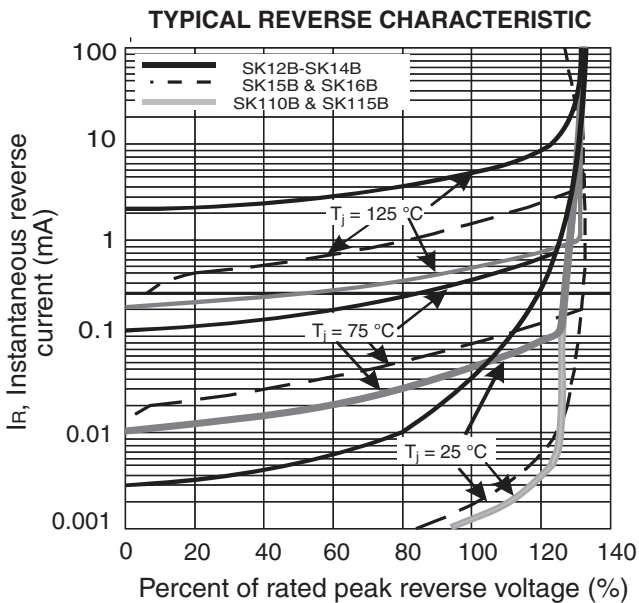
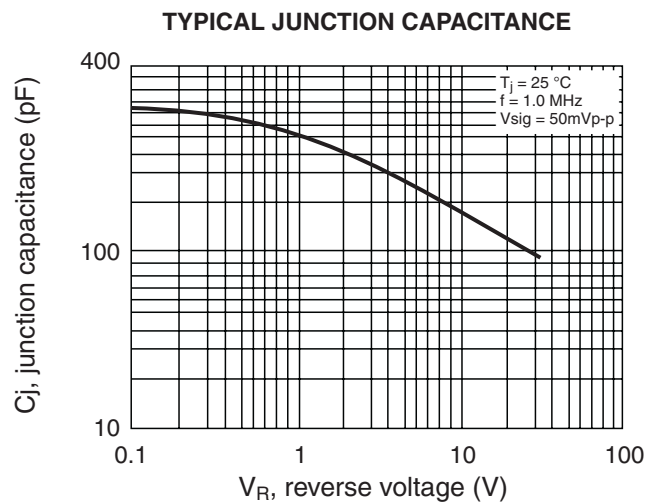
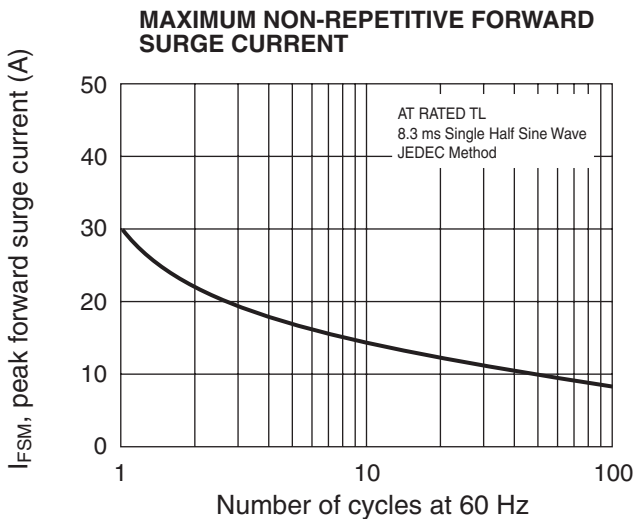
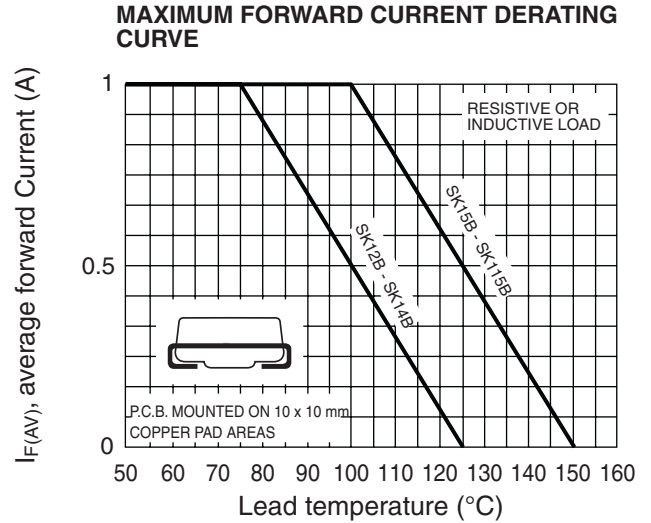
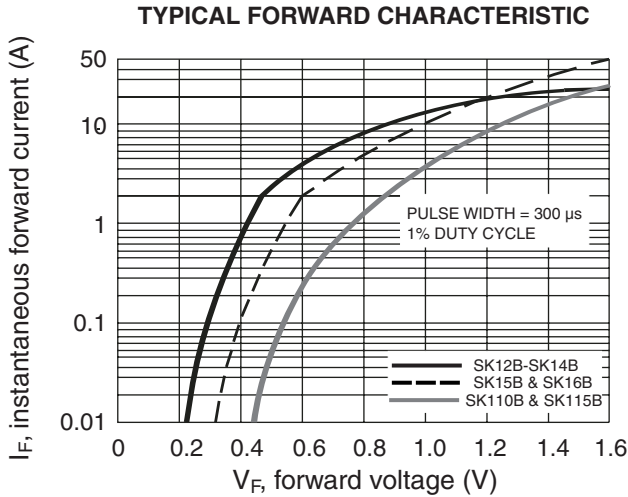

1.0 Amp. Surface Mount Schottky Barrier Rectifiers

Revision History

Date	Revision	Description of Changes
11-Mar-2011	0	Original Data Sheet
28-Oct-2016	1	Format update

Disclaimer

All product, product specifications and data are subject to change without notice to improve reliability, function or design or otherwise.

Fagor Electrónica, S.Coop., its affiliates, agents, and employees, and all persons acting on its or their behalf (collectively, "Fagor"), disclaim any and all liability for any errors, inaccuracies or incompleteness contained in any datasheet or in any other disclosure relating to any product.

Fagor makes no warranty, representation or guarantee regarding the suitability of the products for any particular purpose or the continuing production of any product. To the maximum extent permitted by applicable law, Fagor disclaims (i) any and all liability arising out of the application or use of any product, (ii) any and all liability, including without limitation special, consequential or incidental damages, and (iii) any and all implied warranties, including warranties of fitness for particular purpose, non-infringement and merchantability.

Statements regarding the suitability of products for certain types of applications are based on Fagor's knowledge of typical requirements that are often placed on Fagor products in generic applications. Such statements are not binding statements about the suitability of products for a particular application. It is the customer's responsibility to validate that a particular product with the properties described in the product specification is suitable for use in a particular application. Parameters provided in datasheets and/or specifications may vary in different applications and performance may vary over time. All operating parameters, including typical parameters, must be validated for each customer application by the customer's technical experts. Product specifications do not expand or otherwise modify Fagor's terms and conditions of purchase, including but not limited to the warranty expressed therein.

Except as expressly indicated in writing, Fagor products are not designed for use in medical, life-saving, or life-sustaining applications or for any other application in which the failure of the Fagor product could result in personal injury or death. Customers using or selling Fagor products not expressly indicated for use in such applications do so at their own risk and agree to fully indemnify and hold Fagor and its distributors harmless from and against any and all claims, liabilities, expenses and damages arising or resulting in connection with such use or sale, including attorneys fees, even if such claim alleges that Fagor or its distributor was negligent regarding the design or manufacture of the part. Please contact authorized Fagor personnel to obtain written terms and conditions regarding products designed for such applications.

No license, express or implied, by estoppel or otherwise, to any intellectual property rights is granted by this document or by any conduct of Fagor, Product names and markings noted herein may be trademarks of their respective owners.