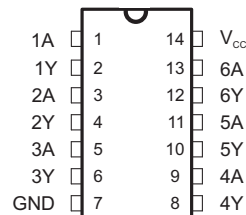
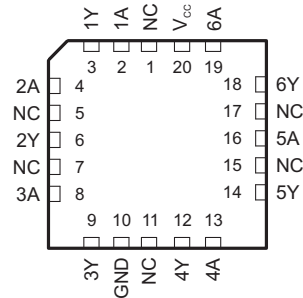

## HEX INVERTERS

 Check for Samples: [SN54HC04](#), [SN74HC04](#)

### FEATURES

- Wide Operating Voltage Range of 2 V to 6 V
- Outputs Can Drive Up To 10 LSTTL Loads
- Low Power Consumption, 20- $\mu$ A Max  $I_{CC}$
- Typical  $t_{pd} = 8$  ns
- $\pm 4$ -mA Output Drive at 5 V
- Low Input Current of 1  $\mu$ A Max

**SN54HC04...J OR W PACKAGE  
SN74HC04...D, DB, N, NS, OR PW PACKAGE  
(TOP VIEW)**

**SN54HC04...FK PACKAGE  
(TOP VIEW)**

NC – No internal connection

### DESCRIPTION/ORDERING INFORMATION

 The 'HC04 devices contain six independent inverters. They perform the Boolean function  $Y = \bar{A}$  in positive logic.

#### ORDERING INFORMATION

$T_A$	PACKAGE <sup>(1)</sup>		ORDERABLE PART NUMBER	TOP-SIDE MARKING
-40°C to 85°C	PDIP – N	Reel of 1000	SN74HC04N	SN74HC04N
		Reel of 1000	SN74HC04DE4	HC04
	SOIC – D	Reel of 2500	SN74HC04DRG3	
		Tube of 250	SN74HC04DT	
	SOP – NS	Reel of 2000	SN74HC04NSR	HC04
			SN74HC04NSRG4	
	SSOP – DB	Reel of 2000	SN74HC04DBR	HC04
			SN74HC04DBRE4	
	TSSOP – PW	Tube of 90	SN74HC04PW	HC04
		Reel of 2000	SN74HC04PWR	
Tube of 250		SN74HC04PWT		
-55°C to 125°C	CDIP – J	Reel of 1000	SNJ54HC04J	
	CFP – W	Reel of 900	SNJ54HC04W	
	LCCC – FK	Reel of 2200	SNJ54HC04FK	

(1) Package drawings, standard packing quantities, thermal data, symbolization, and PCB design guidelines are available at [www.ti.com/sc/package](http://www.ti.com/sc/package).



Please be aware that an important notice concerning availability, standard warranty, and use in critical applications of Texas Instruments semiconductor products and disclaimers thereto appears at the end of this data sheet.

**Table 1. FUNCTION TABLE  
(EACH INVERTER)**

INPUT A	OUTPUT Y
H	L
L	H

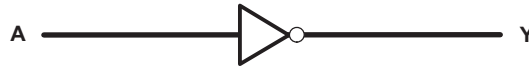
**LOGIC DIAGRAM (POSITIVE LOGIC)**

### Absolute Maximum Ratings<sup>(1)</sup>

over operating free-air temperature range (unless otherwise noted)

		MIN	MAX	UNIT
$V_{CC}$	Supply voltage range	-0.5	7	V
$I_{IK}$	Input clamp current <sup>(2)</sup>	$V_I < 0$ or $V_I > V_{CC}$		$\pm 20$ mA
$I_{OK}$	Output clamp current <sup>(2)</sup>	$V_O < 0$		$\pm 20$ mA
$I_O$	Continuous output current	$V_O = 0$ to $V_{CC}$		$\pm 25$ mA
Continuous current through $V_{CC}$ or GND				$\pm 50$ mA
$\theta_{JA}$	Package thermal impedance <sup>(3)</sup>	D package		86
		N package		80
		NS package		76
		PW package		113
$T_{stg}$	Storage temperature range	-60	150	°C

- (1) Stresses beyond those listed under "absolute maximum ratings" may cause permanent damage to the device. These are stress ratings only, and functional operation of the device at these or any other conditions beyond those indicated under "recommended operating conditions" is not implied. Exposure to absolute-maximum-rated conditions for extended periods may affect device reliability.
- (2) The input and output negative-voltage ratings may be exceeded if the input and output clamp-current ratings are observed.
- (3) The package thermal impedance is calculated in accordance with JESD 51-7.

### Recommended Operating Conditions<sup>(1)</sup>

		SN54HC04			SN74HC04			UNIT
		MIN	NOM	MAX	MIN	NOM	MAX	
$V_{CC}$	Supply voltage	2	5	6	2	5	6	V
$V_{IH}$	High-level input voltage	$V_{CC} = 2$ V		1.5	$V_{CC} = 2$ V		1.5	V
		$V_{CC} = 4.5$ V		3.15	$V_{CC} = 4.5$ V		3.15	
		$V_{CC} = 6$ V		4.2	$V_{CC} = 6$ V		4.2	
$V_{IL}$	Low-level input voltage	$V_{CC} = 2$ V			0.5	$V_{CC} = 2$ V		0.5
		$V_{CC} = 4.5$ V			1.35	$V_{CC} = 4.5$ V		1.35
		$V_{CC} = 6$ V			1.8	$V_{CC} = 6$ V		1.8
$V_I$	Input voltage	0		$V_{CC}$	0		$V_{CC}$	V
$V_O$	Output voltage	0		$V_{CC}$	0		$V_{CC}$	V
$\Delta t/\Delta v$	Input transition rise or fall rate	$V_{CC} = 2$ V			1000	$V_{CC} = 2$ V		1000
		$V_{CC} = 4.5$ V			500	$V_{CC} = 4.5$ V		500
		$V_{CC} = 6$ V			400	$V_{CC} = 6$ V		400
$T_A$	Operating free-air temperature	-55		125	-40		85	°C

- (1) All unused inputs of the device must be held at  $V_{CC}$  or GND to ensure proper device operation. Refer to the TI application report, *Implications of Slow or Floating CMOS Inputs*, literature number SCBA004.

## Electrical Characteristics

over operating free-air temperature range (unless otherwise noted)

PARAMETER	TEST CONDITIONS		V <sub>CC</sub>	T <sub>A</sub> = 25°C			SN54HC04		SN74HC04		UNIT
				MIN	TYP	MAX	MIN	MAX	MIN	MAX	
V <sub>OH</sub>	V <sub>I</sub> = V <sub>IH</sub> or V <sub>IL</sub>	I <sub>OH</sub> = -20 μA	2 V	1.9	1.998		1.9		1.9	V	
			4.5 V	4.4	4.499		4.4		4.4		
			6 V	5.9	5.999		5.9		5.9		
		I <sub>OH</sub> = -4 mA	4.5 V	3.98	4.3		3.7		3.84		
		I <sub>OH</sub> = -5.2 mA	6 V	5.48	5.8		5.2		5.34		
V <sub>OL</sub>	V <sub>I</sub> = V <sub>IH</sub> or V <sub>IL</sub>	I <sub>OL</sub> = 20 μA	2 V		0.002	0.1		0.1		V	
			4.5 V		0.001	0.1		0.1			0.1
			6 V		0.001	0.1		0.1			0.1
		I <sub>OL</sub> = 4 mA	4.5 V		0.17	0.26		0.4			0.33
		I <sub>OL</sub> = 5.2 mA	6 V		0.15	0.26		0.4			0.33
I <sub>I</sub>	V <sub>I</sub> = V <sub>CC</sub> or 0	6 V		±0.1	±100		±1000		±1000	nA	
I <sub>CC</sub>	V <sub>I</sub> = V <sub>CC</sub> or 0, I <sub>O</sub> = 0	6 V					40		20	μA	
C <sub>i</sub>		2 V to 6 V		3	10		10		10	pF	

## Switching Characteristics

 over operating free-air temperature range, C<sub>L</sub> = 50 pF (unless otherwise noted) (see [Figure 1](#))

PARAMETER	FROM (INPUT)	TO (OUTPUT)	V <sub>CC</sub>	T <sub>A</sub> = 25°C			SN54HC04		SN74HC04		UNIT
				MIN	TYP	MAX	MIN	MAX	MIN	MAX	
t <sub>pd</sub>	A	Y	2 V		45	95		125		120	ns
			4.5 V		9	19		29		24	
			6 V		8	16		25		20	
t <sub>t</sub>		Y	2 V		38	75		110		95	ns
			4.5 V		8	15		22		19	
			6 V		6	13		19		16	

## Operating Characteristics

 T<sub>A</sub> = 25°C

PARAMETER	TEST CONDITIONS	TYP	UNIT
C <sub>pd</sub>	Power dissipation capacitance per inverter No load	20	pF

PARAMETER MEASUREMENT INFORMATION

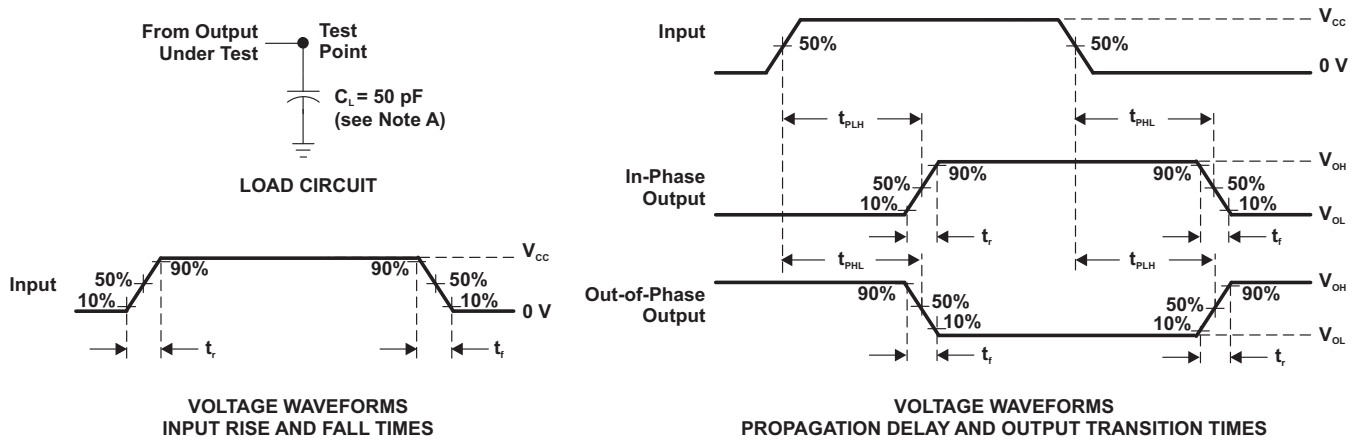

- NOTES: A.  $C_L$  includes probe and test-fixture capacitance.  
 B. Phase relationships between waveforms were chosen arbitrarily. All input pulses are supplied by generators having the following characteristics:  $PRR \leq 1$  MHz,  $Z_o = 50 \Omega$ ,  $t_r = 6$  ns,  $t_f = 6$  ns.  
 C. The outputs are measured one at a time with one input transition per measurement.  
 D.  $t_{PLH}$  and  $t_{PLL}$  are the same as  $t_{pd}$ .

Figure 1. Load Circuit and Voltage Waveforms

**PACKAGING INFORMATION**

Orderable Device	Status <sup>(1)</sup>	Package Type	Package Drawing	Pins	Package Qty	Eco Plan <sup>(2)</sup>	Lead/ Ball Finish	MSL Peak Temp <sup>(3)</sup>	Samples (Requires Login)
5962-8409801VCA	ACTIVE	CDIP	J	14	1	TBD	A42	N / A for Pkg Type	<a href="#">Purchase Samples</a>
5962-8409801VDA	ACTIVE	CFP	W	14	1	TBD	A42	N / A for Pkg Type	<a href="#">Purchase Samples</a>
84098012A	ACTIVE	LCCC	FK	20	1	TBD	POST-PLATE	N / A for Pkg Type	<a href="#">Purchase Samples</a>
8409801CA	ACTIVE	CDIP	J	14	1	TBD	A42	N / A for Pkg Type	<a href="#">Purchase Samples</a>
8409801DA	ACTIVE	CFP	W	14	1	TBD	A42	N / A for Pkg Type	<a href="#">Purchase Samples</a>
JM38510/65701B2A	ACTIVE	LCCC	FK	20	1	TBD	POST-PLATE	N / A for Pkg Type	Contact TI Distributor or Sales Office
JM38510/65701BCA	ACTIVE	CDIP	J	14	1	TBD	A42	N / A for Pkg Type	Contact TI Distributor or Sales Office
SN54HC04J	ACTIVE	CDIP	J	14	1	TBD	A42	N / A for Pkg Type	Contact TI Distributor or Sales Office
SN74HC04D	ACTIVE	SOIC	D	14	50	Green (RoHS & no Sb/Br)	CU NIPDAU	Level-1-260C-UNLIM	<a href="#">Purchase Samples</a>
SN74HC04DBR	ACTIVE	SSOP	DB	14	2000	Green (RoHS & no Sb/Br)	CU NIPDAU	Level-1-260C-UNLIM	Contact TI Distributor or Sales Office
SN74HC04DBRE4	ACTIVE	SSOP	DB	14	2000	Green (RoHS & no Sb/Br)	CU NIPDAU	Level-1-260C-UNLIM	Contact TI Distributor or Sales Office
SN74HC04DBRG4	ACTIVE	SSOP	DB	14	2000	Green (RoHS & no Sb/Br)	CU NIPDAU	Level-1-260C-UNLIM	Contact TI Distributor or Sales Office
SN74HC04DE4	ACTIVE	SOIC	D	14	50	Green (RoHS & no Sb/Br)	CU NIPDAU	Level-1-260C-UNLIM	<a href="#">Purchase Samples</a>
SN74HC04DG4	ACTIVE	SOIC	D	14	50	Green (RoHS & no Sb/Br)	CU NIPDAU	Level-1-260C-UNLIM	<a href="#">Purchase Samples</a>
SN74HC04DR	ACTIVE	SOIC	D	14	2500	Green (RoHS & no Sb/Br)	CU NIPDAU	Level-1-260C-UNLIM	Contact TI Distributor or Sales Office
SN74HC04DRE4	ACTIVE	SOIC	D	14	2500	Green (RoHS & no Sb/Br)	CU NIPDAU	Level-1-260C-UNLIM	Contact TI Distributor or Sales Office
SN74HC04DRG3	ACTIVE	SOIC	D	14	2500	Green (RoHS & no Sb/Br)	CU SN	Level-1-260C-UNLIM	<a href="#">Purchase Samples</a>
SN74HC04DRG4	ACTIVE	SOIC	D	14	2500	Green (RoHS & no Sb/Br)	CU NIPDAU	Level-1-260C-UNLIM	<a href="#">Request Free Samples</a>
SN74HC04DT	ACTIVE	SOIC	D	14	250	Green (RoHS & no Sb/Br)	CU NIPDAU	Level-1-260C-UNLIM	<a href="#">Purchase Samples</a>

Orderable Device	Status <sup>(1)</sup>	Package Type	Package Drawing	Pins	Package Qty	Eco Plan <sup>(2)</sup>	Lead/ Ball Finish	MSL Peak Temp <sup>(3)</sup>	Samples (Requires Login)
SN74HC04DTE4	ACTIVE	SOIC	D	14	250	Green (RoHS & no Sb/Br)	CU NIPDAU	Level-1-260C-UNLIM	<a href="#">Purchase Samples</a>
SN74HC04DTG4	ACTIVE	SOIC	D	14	250	Green (RoHS & no Sb/Br)	CU NIPDAU	Level-1-260C-UNLIM	<a href="#">Purchase Samples</a>
SN74HC04N	ACTIVE	PDIP	N	14	25	Pb-Free (RoHS)	CU NIPDAU	N / A for Pkg Type	Contact TI Distributor or Sales Office
SN74HC04N3	OBSOLETE	PDIP	N	14		TBD	Call TI	Call TI	Samples Not Available
SN74HC04NE4	ACTIVE	PDIP	N	14	25	Pb-Free (RoHS)	CU NIPDAU	N / A for Pkg Type	Contact TI Distributor or Sales Office
SN74HC04NSR	ACTIVE	SO	NS	14	2000	Green (RoHS & no Sb/Br)	CU NIPDAU	Level-1-260C-UNLIM	Contact TI Distributor or Sales Office
SN74HC04NSRG4	ACTIVE	SO	NS	14	2000	Green (RoHS & no Sb/Br)	CU NIPDAU	Level-1-260C-UNLIM	Contact TI Distributor or Sales Office
SN74HC04PW	ACTIVE	TSSOP	PW	14	90	Green (RoHS & no Sb/Br)	CU NIPDAU	Level-1-260C-UNLIM	<a href="#">Purchase Samples</a>
SN74HC04PWE4	ACTIVE	TSSOP	PW	14	90	Green (RoHS & no Sb/Br)	CU NIPDAU	Level-1-260C-UNLIM	<a href="#">Purchase Samples</a>
SN74HC04PWG4	ACTIVE	TSSOP	PW	14	90	Green (RoHS & no Sb/Br)	CU NIPDAU	Level-1-260C-UNLIM	<a href="#">Purchase Samples</a>
SN74HC04PWLE	OBSOLETE	TSSOP	PW	14		TBD	Call TI	Call TI	Samples Not Available
SN74HC04PWR	ACTIVE	TSSOP	PW	14	2000	Green (RoHS & no Sb/Br)	CU NIPDAU	Level-1-260C-UNLIM	Contact TI Distributor or Sales Office
SN74HC04PWRE4	ACTIVE	TSSOP	PW	14	2000	Green (RoHS & no Sb/Br)	CU NIPDAU	Level-1-260C-UNLIM	Contact TI Distributor or Sales Office
SN74HC04PWRG4	ACTIVE	TSSOP	PW	14	2000	Green (RoHS & no Sb/Br)	CU NIPDAU	Level-1-260C-UNLIM	Contact TI Distributor or Sales Office
SN74HC04PWT	ACTIVE	TSSOP	PW	14	250	Green (RoHS & no Sb/Br)	CU NIPDAU	Level-1-260C-UNLIM	<a href="#">Purchase Samples</a>
SN74HC04PWTE4	ACTIVE	TSSOP	PW	14	250	Green (RoHS & no Sb/Br)	CU NIPDAU	Level-1-260C-UNLIM	<a href="#">Purchase Samples</a>
SN74HC04PWTG4	ACTIVE	TSSOP	PW	14	250	Green (RoHS & no Sb/Br)	CU NIPDAU	Level-1-260C-UNLIM	<a href="#">Purchase Samples</a>
SNJ54HC04FK	ACTIVE	LCCC	FK	20	1	TBD	POST-PLATE	N / A for Pkg Type	Contact TI Distributor or Sales Office
SNJ54HC04J	ACTIVE	CDIP	J	14	1	TBD	A42	N / A for Pkg Type	Contact TI Distributor or Sales Office

Orderable Device	Status <sup>(1)</sup>	Package Type	Package Drawing	Pins	Package Qty	Eco Plan <sup>(2)</sup>	Lead/Ball Finish	MSL Peak Temp <sup>(3)</sup>	Samples (Requires Login)
SNJ54HC04W	ACTIVE	CFP	W	14	1	TBD	A42	N / A for Pkg Type	Contact TI Distributor or Sales Office
SNV54HC04J	ACTIVE	CDIP	J	14		TBD	Call TI	Call TI	<a href="#">Purchase Samples</a>
SNV54HC04W	ACTIVE	CFP	W	14		TBD	Call TI	Call TI	<a href="#">Purchase Samples</a>

<sup>(1)</sup> The marketing status values are defined as follows:

**ACTIVE:** Product device recommended for new designs.

**LIFEBUY:** TI has announced that the device will be discontinued, and a lifetime-buy period is in effect.

**NRND:** Not recommended for new designs. Device is in production to support existing customers, but TI does not recommend using this part in a new design.

**PREVIEW:** Device has been announced but is not in production. Samples may or may not be available.

**OBSELETE:** TI has discontinued the production of the device.

<sup>(2)</sup> Eco Plan - The planned eco-friendly classification: Pb-Free (RoHS), Pb-Free (RoHS Exempt), or Green (RoHS & no Sb/Br) - please check <http://www.ti.com/productcontent> for the latest availability information and additional product content details.

**TBD:** The Pb-Free/Green conversion plan has not been defined.

**Pb-Free (RoHS):** TI's terms "Lead-Free" or "Pb-Free" mean semiconductor products that are compatible with the current RoHS requirements for all 6 substances, including the requirement that lead not exceed 0.1% by weight in homogeneous materials. Where designed to be soldered at high temperatures, TI Pb-Free products are suitable for use in specified lead-free processes.

**Pb-Free (RoHS Exempt):** This component has a RoHS exemption for either 1) lead-based flip-chip solder bumps used between the die and package, or 2) lead-based die adhesive used between the die and leadframe. The component is otherwise considered Pb-Free (RoHS compatible) as defined above.

**Green (RoHS & no Sb/Br):** TI defines "Green" to mean Pb-Free (RoHS compatible), and free of Bromine (Br) and Antimony (Sb) based flame retardants (Br or Sb do not exceed 0.1% by weight in homogeneous material)

<sup>(3)</sup> MSL, Peak Temp. -- The Moisture Sensitivity Level rating according to the JEDEC industry standard classifications, and peak solder temperature.

**Important Information and Disclaimer:** The information provided on this page represents TI's knowledge and belief as of the date that it is provided. TI bases its knowledge and belief on information provided by third parties, and makes no representation or warranty as to the accuracy of such information. Efforts are underway to better integrate information from third parties. TI has taken and continues to take reasonable steps to provide representative and accurate information but may not have conducted destructive testing or chemical analysis on incoming materials and chemicals. TI and TI suppliers consider certain information to be proprietary, and thus CAS numbers and other limited information may not be available for release.

In no event shall TI's liability arising out of such information exceed the total purchase price of the TI part(s) at issue in this document sold by TI to Customer on an annual basis.

**OTHER QUALIFIED VERSIONS OF SN54HC04, SN54HC04-SP, SN74HC04 :**

● Catalog: [SN74HC04](#), [SN54HC04](#)

● Automotive: [SN74HC04-Q1](#), [SN74HC04-Q1](#)

● Military: [SN54HC04](#)

- Space: [SN54HC04-SP](#)

NOTE: Qualified Version Definitions:

- Catalog - TI's standard catalog product
- Automotive - Q100 devices qualified for high-reliability automotive applications targeting zero defects
- Military - QML certified for Military and Defense Applications
- Space - Radiation tolerant, ceramic packaging and qualified for use in Space-based application



**TAPE AND REEL INFORMATION**

**QUADRANT ASSIGNMENTS FOR PIN 1 ORIENTATION IN TAPE**

\*All dimensions are nominal

Device	Package Type	Package Drawing	Pins	SPQ	Reel Diameter (mm)	Reel Width W1 (mm)	A0 (mm)	B0 (mm)	K0 (mm)	P1 (mm)	W (mm)	Pin1 Quadrant
SN74HC04DBR	SSOP	DB	14	2000	330.0	16.4	8.2	6.6	2.5	12.0	16.0	Q1
SN74HC04DR	SOIC	D	14	2500	330.0	16.4	6.5	9.0	2.1	8.0	16.0	Q1
SN74HC04DR	SOIC	D	14	2500	330.0	16.4	6.5	9.0	2.1	8.0	16.0	Q1
SN74HC04DT	SOIC	D	14	250	330.0	16.4	6.5	9.0	2.1	8.0	16.0	Q1
SN74HC04NSR	SO	NS	14	2000	330.0	16.4	8.2	10.5	2.5	12.0	16.0	Q1
SN74HC04PWR	TSSOP	PW	14	2000	330.0	12.4	6.9	5.6	1.6	8.0	12.0	Q1
SN74HC04PWT	TSSOP	PW	14	250	330.0	12.4	6.9	5.6	1.6	8.0	12.0	Q1

**TAPE AND REEL BOX DIMENSIONS**

\*All dimensions are nominal

Device	Package Type	Package Drawing	Pins	SPQ	Length (mm)	Width (mm)	Height (mm)
SN74HC04DBR	SSOP	DB	14	2000	346.0	346.0	33.0
SN74HC04DR	SOIC	D	14	2500	346.0	346.0	33.0
SN74HC04DR	SOIC	D	14	2500	333.2	345.9	28.6
SN74HC04DT	SOIC	D	14	250	346.0	346.0	33.0
SN74HC04NSR	SO	NS	14	2000	346.0	346.0	33.0
SN74HC04PWR	TSSOP	PW	14	2000	346.0	346.0	29.0
SN74HC04PWT	TSSOP	PW	14	250	346.0	346.0	29.0

J (R-GDIP-T\*\*)

14 LEADS SHOWN

CERAMIC DUAL IN-LINE PACKAGE



DIM \ PINS **	14	16	18	20
A	0.300 (7,62) BSC	0.300 (7,62) BSC	0.300 (7,62) BSC	0.300 (7,62) BSC
B MAX	0.785 (19,94)	.840 (21,34)	0.960 (24,38)	1.060 (26,92)
B MIN	—	—	—	—
C MAX	0.300 (7,62)	0.300 (7,62)	0.310 (7,87)	0.300 (7,62)
C MIN	0.245 (6,22)	0.245 (6,22)	0.220 (5,59)	0.245 (6,22)



4040083/F 03/03

- NOTES:
- All linear dimensions are in inches (millimeters).
  - This drawing is subject to change without notice.
  - This package is hermetically sealed with a ceramic lid using glass frit.
  - Index point is provided on cap for terminal identification only on press ceramic glass frit seal only.
  - Falls within MIL STD 1835 GDIP1-T14, GDIP1-T16, GDIP1-T18 and GDIP1-T20.

W (R-GDFP-F14)

CERAMIC DUAL FLATPACK



- NOTES:
- A. All linear dimensions are in inches (millimeters).
  - B. This drawing is subject to change without notice.
  - C. This package can be hermetically sealed with a ceramic lid using glass frit.
  - D. Index point is provided on cap for terminal identification only.
  - E. Falls within MIL STD 1835 GDFP1-F14 and JEDEC MO-092AB

FK (S-CQCC-N\*\*)

LEADLESS CERAMIC CHIP CARRIER

28 TERMINAL SHOWN



NO. OF TERMINALS **	A		B	
	MIN	MAX	MIN	MAX
20	0.342 (8,69)	0.358 (9,09)	0.307 (7,80)	0.358 (9,09)
28	0.442 (11,23)	0.458 (11,63)	0.406 (10,31)	0.458 (11,63)
44	0.640 (16,26)	0.660 (16,76)	0.495 (12,58)	0.560 (14,22)
52	0.740 (18,78)	0.761 (19,32)	0.495 (12,58)	0.560 (14,22)
68	0.938 (23,83)	0.962 (24,43)	0.850 (21,6)	0.858 (21,8)
84	1.141 (28,99)	1.165 (29,59)	1.047 (26,6)	1.063 (27,0)



4040140/D 01/11

- NOTES:
- All linear dimensions are in inches (millimeters).
  - This drawing is subject to change without notice.
  - This package can be hermetically sealed with a metal lid.
  - Falls within JEDEC MS-004

N (R-PDIP-T\*\*)

PLASTIC DUAL-IN-LINE PACKAGE

16 PINS SHOWN



4040049/E 12/2002

- NOTES:
- A. All linear dimensions are in inches (millimeters).
  - B. This drawing is subject to change without notice.
  - $\triangle C$  Falls within JEDEC MS-001, except 18 and 20 pin minimum body length (Dim A).
  - $\triangle D$  The 20 pin end lead shoulder width is a vendor option, either half or full width.

D (R-PDSO-G14)

PLASTIC SMALL OUTLINE



- NOTES:
- A. All linear dimensions are in inches (millimeters).
  - B. This drawing is subject to change without notice.
  - $\triangle C$  Body length does not include mold flash, protrusions, or gate burrs. Mold flash, protrusions, or gate burrs shall not exceed 0.006 (0,15) each side.
  - $\triangle D$  Body width does not include interlead flash. Interlead flash shall not exceed 0.017 (0,43) each side.
  - E. Reference JEDEC MS-012 variation AB.

D (R-PDSO-G14)

PLASTIC SMALL OUTLINE

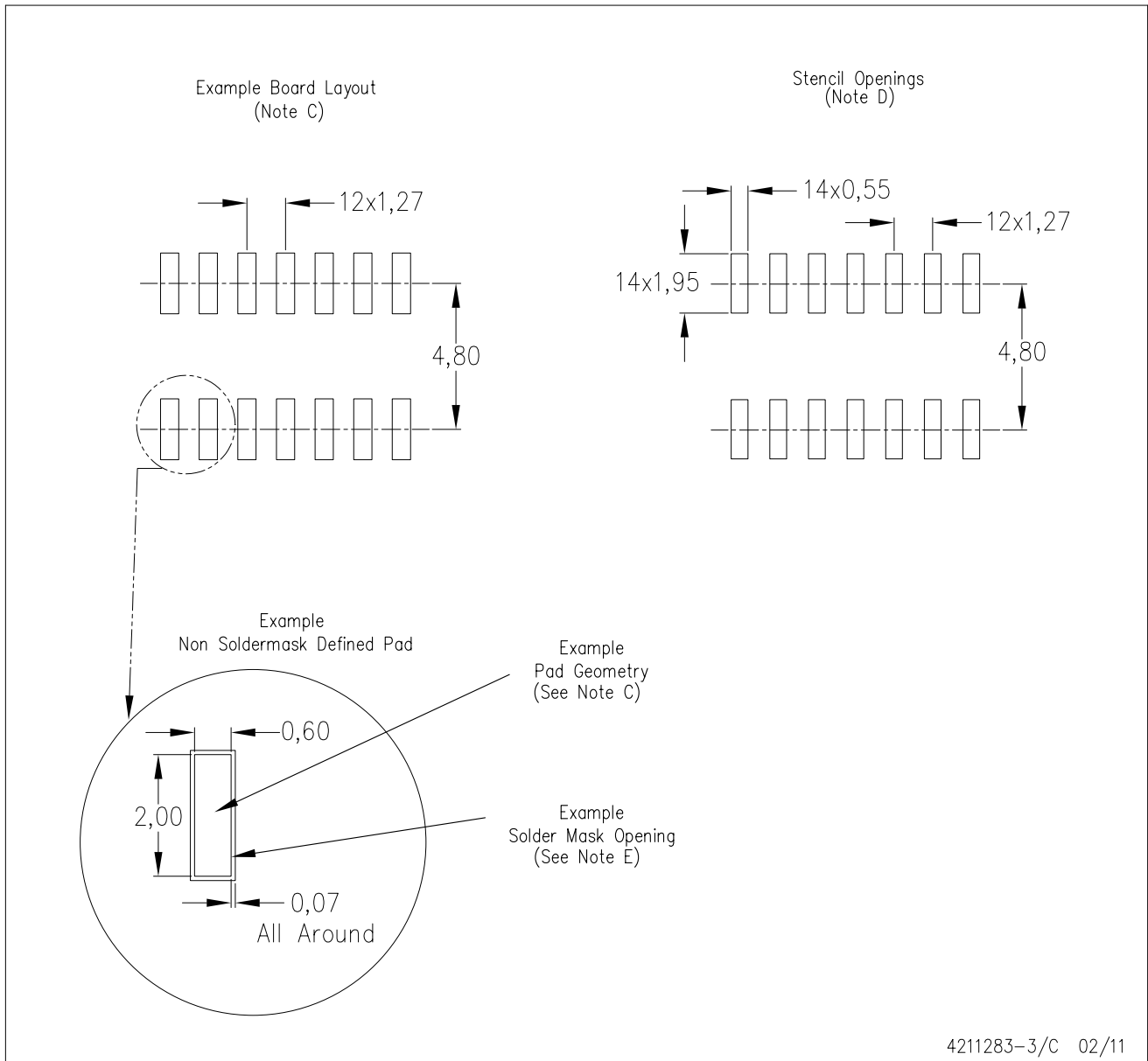

- NOTES:
- All linear dimensions are in millimeters.
  - This drawing is subject to change without notice.
  - Publication IPC-7351 is recommended for alternate designs.
  - Laser cutting apertures with trapezoidal walls and also rounding corners will offer better paste release. Customers should contact their board assembly site for stencil design recommendations. Refer to IPC-7525 for other stencil recommendations.
  - Customers should contact their board fabrication site for solder mask tolerances between and around signal pads.



PW (R-PDSO-G14)

PLASTIC SMALL OUTLINE

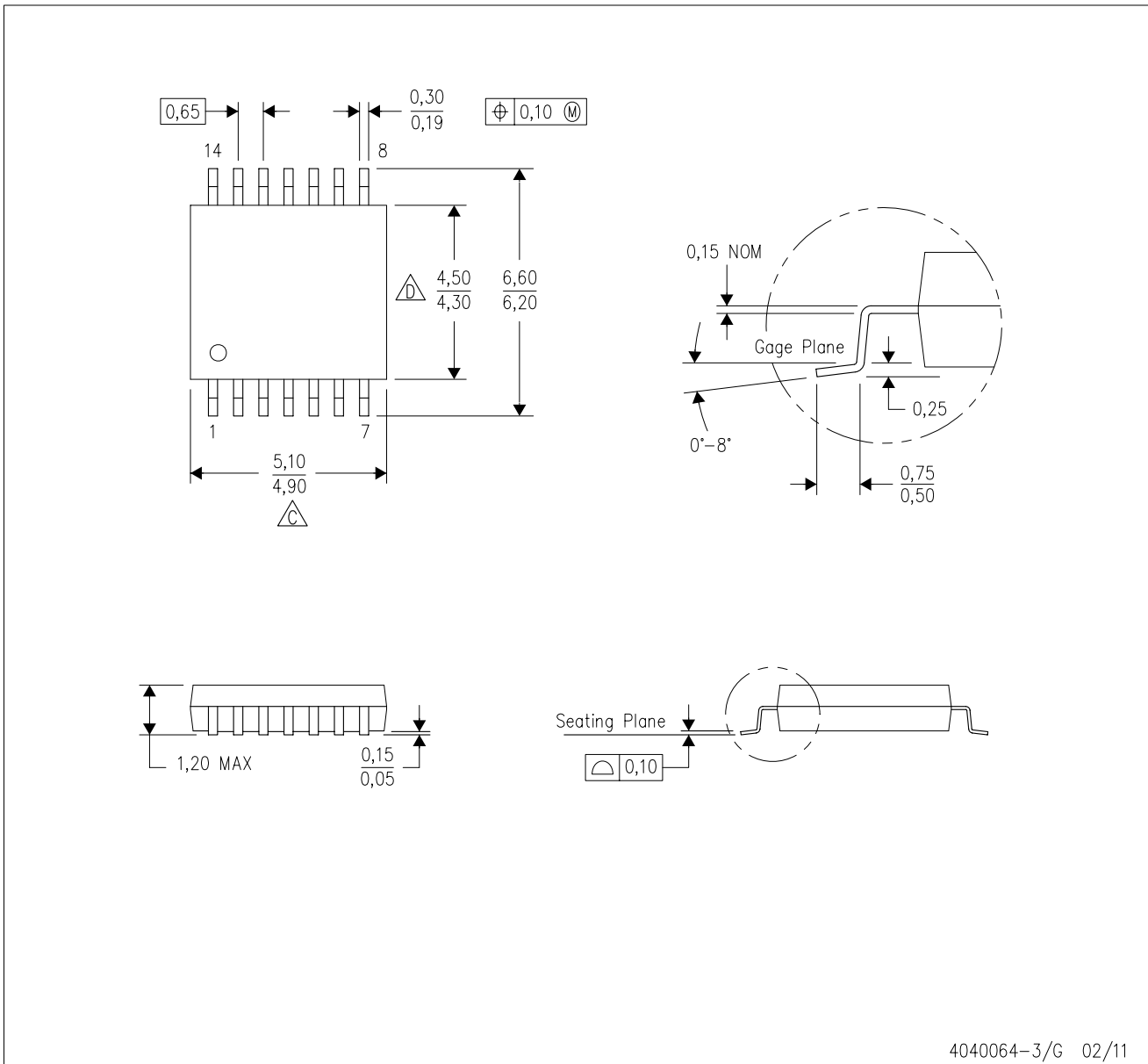

4040064-3/G 02/11

- NOTES:
- A. All linear dimensions are in millimeters. Dimensioning and tolerancing per ASME Y14.5M-1994.
  - B. This drawing is subject to change without notice.
  - C. Body length does not include mold flash, protrusions, or gate burrs. Mold flash, protrusions, or gate burrs shall not exceed 0,15 each side.
  - D. Body width does not include interlead flash. Interlead flash shall not exceed 0,25 each side.
  - E. Falls within JEDEC MO-153

PW (R-PDSO-G14)

PLASTIC SMALL OUTLINE

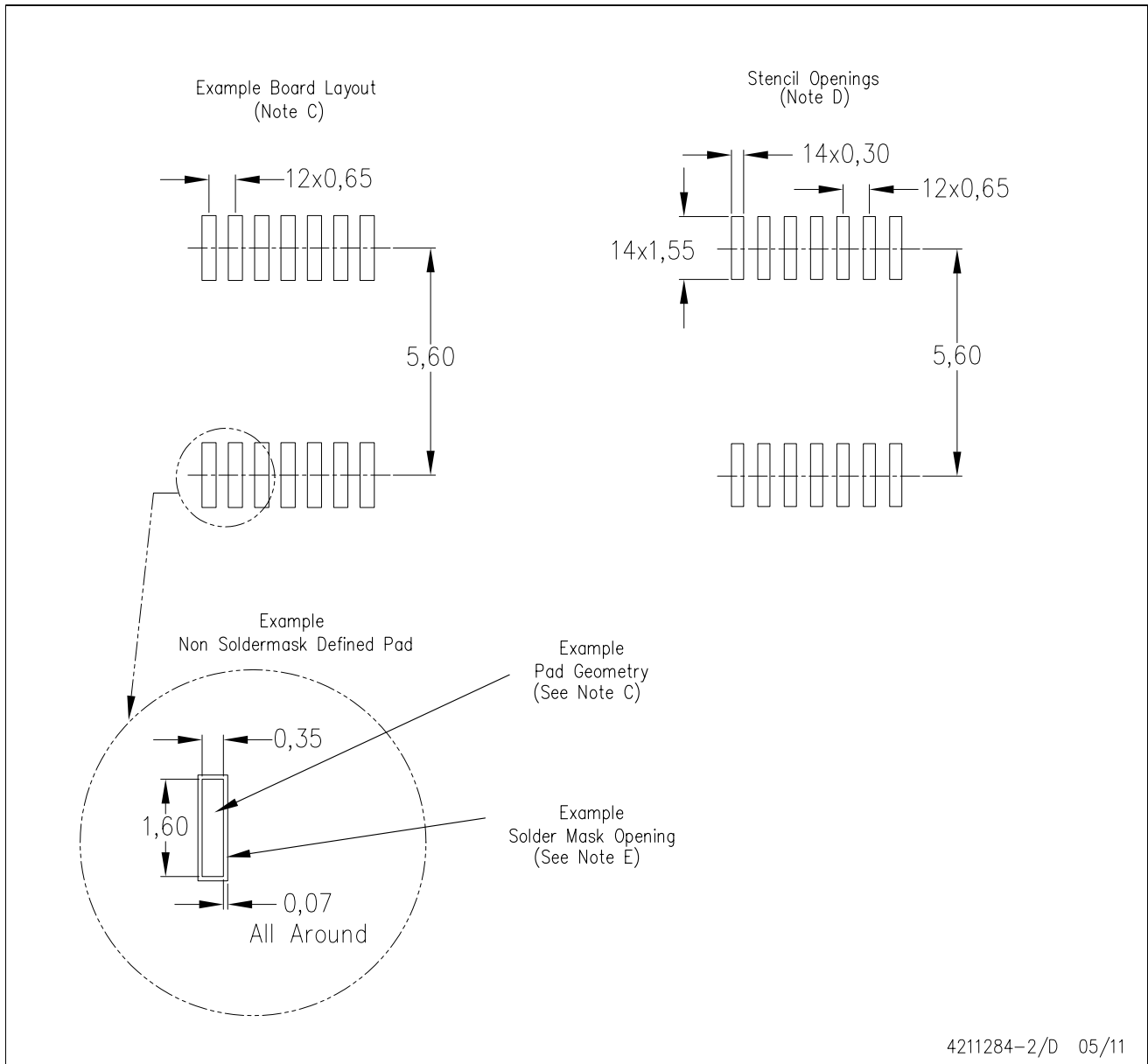

- NOTES:
- All linear dimensions are in millimeters.
  - This drawing is subject to change without notice.
  - Publication IPC-7351 is recommended for alternate designs.
  - Laser cutting apertures with trapezoidal walls and also rounding corners will offer better paste release. Customers should contact their board assembly site for stencil design recommendations. Refer to IPC-7525 for other stencil recommendations.
  - Customers should contact their board fabrication site for solder mask tolerances between and around signal pads.

# MECHANICAL DATA

NS (R-PDSO-G\*\*)

PLASTIC SMALL-OUTLINE PACKAGE

14-PINS SHOWN



- NOTES:
- A. All linear dimensions are in millimeters.
  - B. This drawing is subject to change without notice.
  - C. Body dimensions do not include mold flash or protrusion, not to exceed 0,15.

DB (R-PDSO-G\*\*)

PLASTIC SMALL-OUTLINE

28 PINS SHOWN



- NOTES: A. All linear dimensions are in millimeters.  
 B. This drawing is subject to change without notice.  
 C. Body dimensions do not include mold flash or protrusion not to exceed 0,15.  
 D. Falls within JEDEC MO-150

## IMPORTANT NOTICE

Texas Instruments Incorporated and its subsidiaries (TI) reserve the right to make corrections, modifications, enhancements, improvements, and other changes to its products and services at any time and to discontinue any product or service without notice. Customers should obtain the latest relevant information before placing orders and should verify that such information is current and complete. All products are sold subject to TI's terms and conditions of sale supplied at the time of order acknowledgment.

TI warrants performance of its hardware products to the specifications applicable at the time of sale in accordance with TI's standard warranty. Testing and other quality control techniques are used to the extent TI deems necessary to support this warranty. Except where mandated by government requirements, testing of all parameters of each product is not necessarily performed.

TI assumes no liability for applications assistance or customer product design. Customers are responsible for their products and applications using TI components. To minimize the risks associated with customer products and applications, customers should provide adequate design and operating safeguards.

TI does not warrant or represent that any license, either express or implied, is granted under any TI patent right, copyright, mask work right, or other TI intellectual property right relating to any combination, machine, or process in which TI products or services are used. Information published by TI regarding third-party products or services does not constitute a license from TI to use such products or services or a warranty or endorsement thereof. Use of such information may require a license from a third party under the patents or other intellectual property of the third party, or a license from TI under the patents or other intellectual property of TI.

Reproduction of TI information in TI data books or data sheets is permissible only if reproduction is without alteration and is accompanied by all associated warranties, conditions, limitations, and notices. Reproduction of this information with alteration is an unfair and deceptive business practice. TI is not responsible or liable for such altered documentation. Information of third parties may be subject to additional restrictions.

Resale of TI products or services with statements different from or beyond the parameters stated by TI for that product or service voids all express and any implied warranties for the associated TI product or service and is an unfair and deceptive business practice. TI is not responsible or liable for any such statements.

TI products are not authorized for use in safety-critical applications (such as life support) where a failure of the TI product would reasonably be expected to cause severe personal injury or death, unless officers of the parties have executed an agreement specifically governing such use. Buyers represent that they have all necessary expertise in the safety and regulatory ramifications of their applications, and acknowledge and agree that they are solely responsible for all legal, regulatory and safety-related requirements concerning their products and any use of TI products in such safety-critical applications, notwithstanding any applications-related information or support that may be provided by TI. Further, Buyers must fully indemnify TI and its representatives against any damages arising out of the use of TI products in such safety-critical applications.

TI products are neither designed nor intended for use in military/aerospace applications or environments unless the TI products are specifically designated by TI as military-grade or "enhanced plastic." Only products designated by TI as military-grade meet military specifications. Buyers acknowledge and agree that any such use of TI products which TI has not designated as military-grade is solely at the Buyer's risk, and that they are solely responsible for compliance with all legal and regulatory requirements in connection with such use.

TI products are neither designed nor intended for use in automotive applications or environments unless the specific TI products are designated by TI as compliant with ISO/TS 16949 requirements. Buyers acknowledge and agree that, if they use any non-designated products in automotive applications, TI will not be responsible for any failure to meet such requirements.

Following are URLs where you can obtain information on other Texas Instruments products and application solutions:

### Products

Audio	<a href="http://www.ti.com/audio">www.ti.com/audio</a>
Amplifiers	<a href="http://amplifier.ti.com">amplifier.ti.com</a>
Data Converters	<a href="http://dataconverter.ti.com">dataconverter.ti.com</a>
DLP® Products	<a href="http://www.dlp.com">www.dlp.com</a>
DSP	<a href="http://dsp.ti.com">dsp.ti.com</a>
Clocks and Timers	<a href="http://www.ti.com/clocks">www.ti.com/clocks</a>
Interface	<a href="http://interface.ti.com">interface.ti.com</a>
Logic	<a href="http://logic.ti.com">logic.ti.com</a>
Power Mgmt	<a href="http://power.ti.com">power.ti.com</a>
Microcontrollers	<a href="http://microcontroller.ti.com">microcontroller.ti.com</a>
RFID	<a href="http://www.ti-rfid.com">www.ti-rfid.com</a>
RF/IF and ZigBee® Solutions	<a href="http://www.ti.com/lprf">www.ti.com/lprf</a>

### Applications

Communications and Telecom	<a href="http://www.ti.com/communications">www.ti.com/communications</a>
Computers and Peripherals	<a href="http://www.ti.com/computers">www.ti.com/computers</a>
Consumer Electronics	<a href="http://www.ti.com/consumer-apps">www.ti.com/consumer-apps</a>
Energy and Lighting	<a href="http://www.ti.com/energy">www.ti.com/energy</a>
Industrial	<a href="http://www.ti.com/industrial">www.ti.com/industrial</a>
Medical	<a href="http://www.ti.com/medical">www.ti.com/medical</a>
Security	<a href="http://www.ti.com/security">www.ti.com/security</a>
Space, Avionics and Defense	<a href="http://www.ti.com/space-avionics-defense">www.ti.com/space-avionics-defense</a>
Transportation and Automotive	<a href="http://www.ti.com/automotive">www.ti.com/automotive</a>
Video and Imaging	<a href="http://www.ti.com/video">www.ti.com/video</a>
Wireless	<a href="http://www.ti.com/wireless-apps">www.ti.com/wireless-apps</a>

TI E2E Community Home Page

[e2e.ti.com](http://e2e.ti.com)

Mailing Address: Texas Instruments, Post Office Box 655303, Dallas, Texas 75265  
Copyright © 2011, Texas Instruments Incorporated