

# HD75173

## Quadruple Differential Line Receivers With 3 State Outputs

REJ03D0310-0200Z  
 (Previous ADE-205-592 (Z))  
 Rev.2.00  
 Jul.16.2004

### Description

The HD75173 is a quadruple differential line receiver with three state outputs. It is designed to satisfy the requirements of EIA standards RS-422A, RS-423A and several CCITT recommendations. Each receiver features an active high enable and an active low enable common to all four receivers. It also features differential input sensitivity of  $\pm 200$  mV.

### Features

- Ordering Information

Part Name	Package Type	Package Code	Package Abbreviation	Taping Abbreviation (Quantity)
HD75173P	DILP-16 pin	DP-16E, -16FV	P	—

### Function Table

Differential Inputs A-B	Enables		Output Y
	G	$\bar{G}$	
$V_{ID} \geq 0.2$ V	H	X	H
	X	L	H
$-0.2$ V $< V_{ID} < 0.2$ V	H	X	?
	X	L	?
$V_{ID} \leq -0.2$ V	H	X	L
	X	L	L
X	L	H	Z

H : High level  
 L : Low level  
 X : Irrelevant  
 ? : Indeterminate  
 Z : High impedance

Pin Arrangement

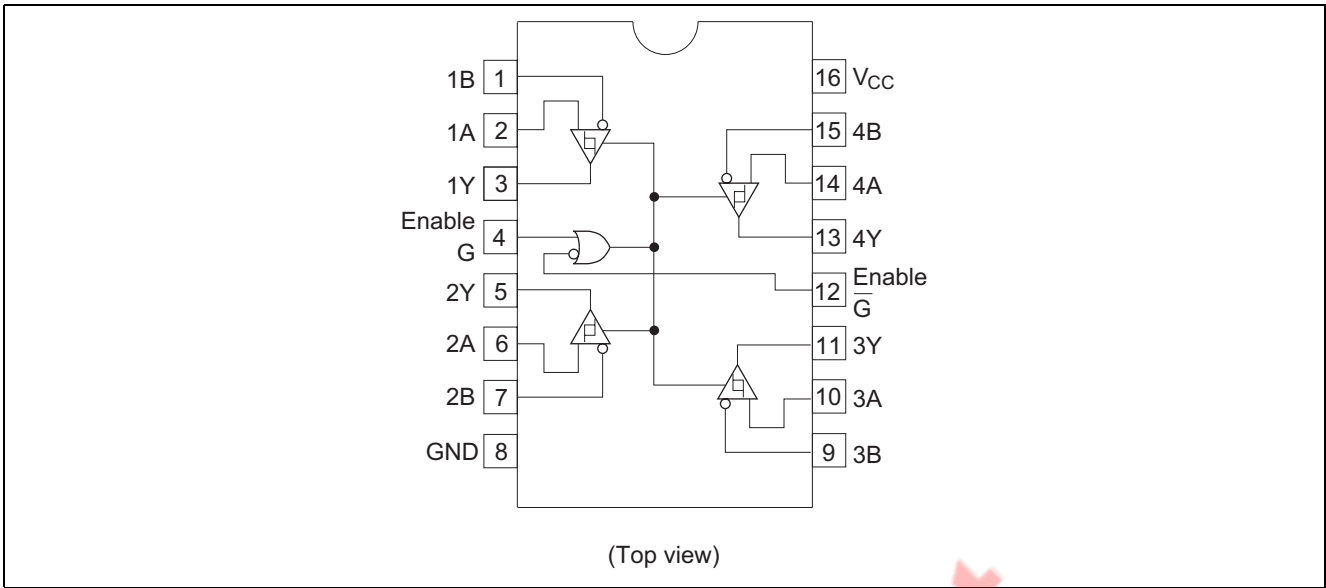

Absolute Maximum Ratings (Ta = 0 to 70°C)

Item	Symbol	Rating	Unit
Supply Voltage	V <sub>CC</sub>	7	V
Input Voltage, A or B Inputs	V <sub>IN</sub>	±25	V
Differential Input Voltage*1	V <sub>ID</sub>	±25	V
Enable Input Voltage	V <sub>IE</sub>	7	V
Output Current	I <sub>OL</sub>	50	mA
Power Dissipation (Ta = 25°C)	P <sub>T</sub>	1150	mW
Operating temperature range	Topr	0 to 70	°C
Storage Temperature Range	Tstg	-65 to +150	°C

- Notes: 1. Differential input voltage is measured at the noninverting input with respect to the corresponding inverting input
2. The absolute maximum ratings are values which must not individually be exceeded, and furthermore, no two of which may be realized at the same time.

Recommended Operating Conditions

Item	Symbol	Min	Typ	Max	Unit
Supply Voltage	V <sub>CC</sub>	4.75	5.00	5.25	V
Common Mode Input Voltage	V <sub>IN</sub>	—	—	±12	V
Differential Input Voltage	V <sub>ID</sub>	—	—	±12	V
Output Current	V <sub>OH</sub>	—	—	-400	μA
	V <sub>OL</sub>	—	—	16	mA
Operating Temperature	Topr	0	—	70	°C

**DC Electrical Characteristics (Ta = 0 to 70°C)**

Item	Symbol	Min	Typ *1	Max	Unit	Conditions
Differential Input High Threshold Voltage	$V_{TH}$	—	—	0.2	V	$V_O = 2.7\text{ V}, I_O = -0.4\text{ mA}$
Differential Output Low Threshold Voltage	$V_{TL}$	-0.2*2	—	—	V	$V_O = 0.5\text{ V}, I_O = 16\text{ mA}$
Hysteresis	$V_{T^+} - V_{T^-}$	—	50	—	mV	
Enable Input Voltage	$V_{IH}$	2	—	—	V	
	$V_{IL}$	—	—	0.8		
Enable Input Clamp Voltage	$V_{IK}$	—	—	-1.5	V	$I_I = -18\text{ mA}$
Output Voltage	$V_{OH}$	2.7	—	—	V	$V_{ID} = 200\text{ mV}, I_{OH} = -400\text{ }\mu\text{A}$
	$V_{OL}$	—	—	0.45	V	$V_{ID} = -200\text{ mV}, I_{OL} = 8\text{ mA}$
		—	—	0.5		$V_{ID} = -200\text{ mV}, I_{OL} = 16\text{ mA}$
High Impedance State Output Current	$V_{OZ}$	—	—	-20	$\mu\text{A}$	$V_O = 0.4\text{ V}$
		—	—	+20		$V_O = 2.4\text{ V}$
Line Input Current	$I_I$	—	—	1	mA	Other Input at 0 V*4
		—	—	-0.8		
Enable Input Current	$I_{IH}$	—	—	20	$\mu\text{A}$	$V_{IH} = 2.7\text{ V}$
	$I_{IL}$	—	—	-100	$\mu\text{A}$	$V_{IL} = 0.4\text{ V}$
Input Resistance	$r_i$	12	—	—	k $\Omega$	
Short Circuit Output Current*3	$I_{OS}$	-15	—	-85	mA	
Supply Current	$I_{CC}$	—	—	70	mA	

- Notes: 1. All Typical Values are at  $V_{CC} = 5\text{ V}, T_a = 25^\circ\text{C}$   
 2. The algebraic convention is used in this data sheet for threshold voltage levels only.  
 3. Not more than one output should be shorted at a time.  
 4. Refer to EIA standards RS-422A and RS-423A for exact conditions.

**Switching Characteristics ( $V_{CC} = 5\text{ V}, T_a = 25^\circ\text{C}$ )**

Item	Symbol	Min	Typ	Max	Unit	Test Conditions
Propagation Delay Time	$t_{PLH}$	—	20	35	ns	$C_L = 15\text{ pF}$
	$t_{PHL}$	—	22	35		
Output Enable Time	$t_{ZH}$	—	17	22		$C_L = 15\text{ pF}$
	$t_{ZL}$	—	20	25		
Output Disable Time	$t_{HZ}$	—	21	30		$C_L = 5\text{ pF}$
	$t_{LZ}$	—	30	40		

## Switching Time Test Method

### 1. $t_{PLH}$ , $t_{PHL}$

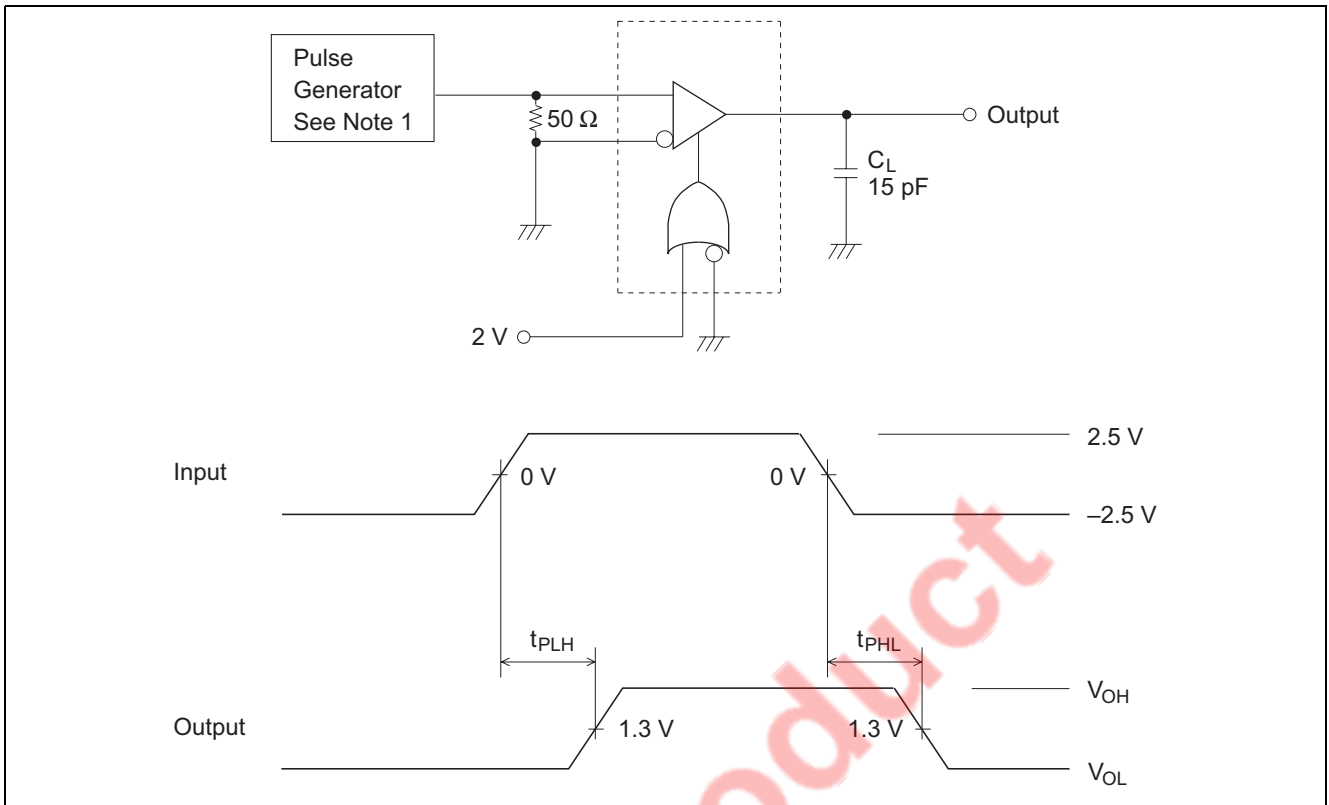

2.  $t_{ZH}$ ,  $t_{ZL}$

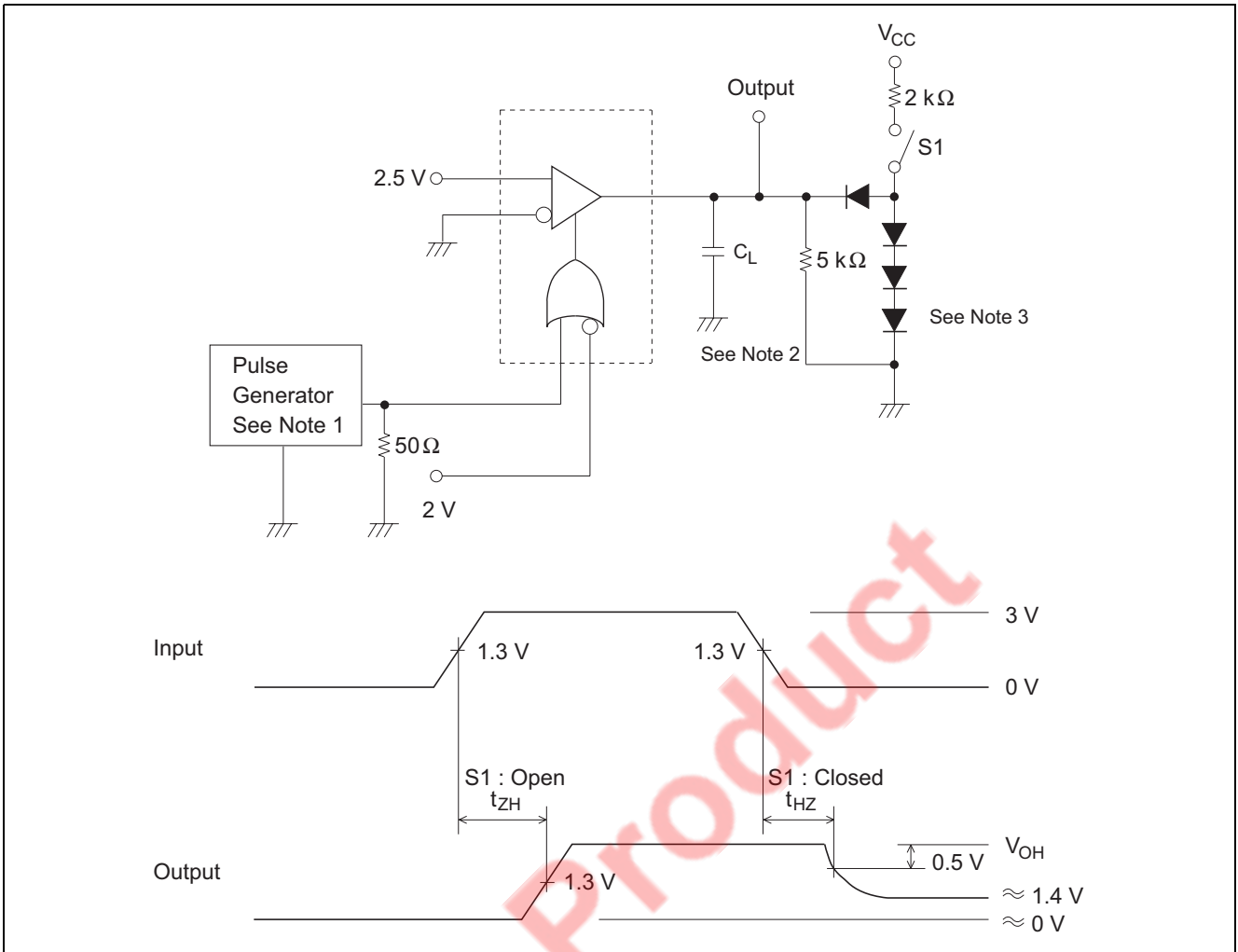

3.  $t_{ZL}$ ,  $t_{LZ}$

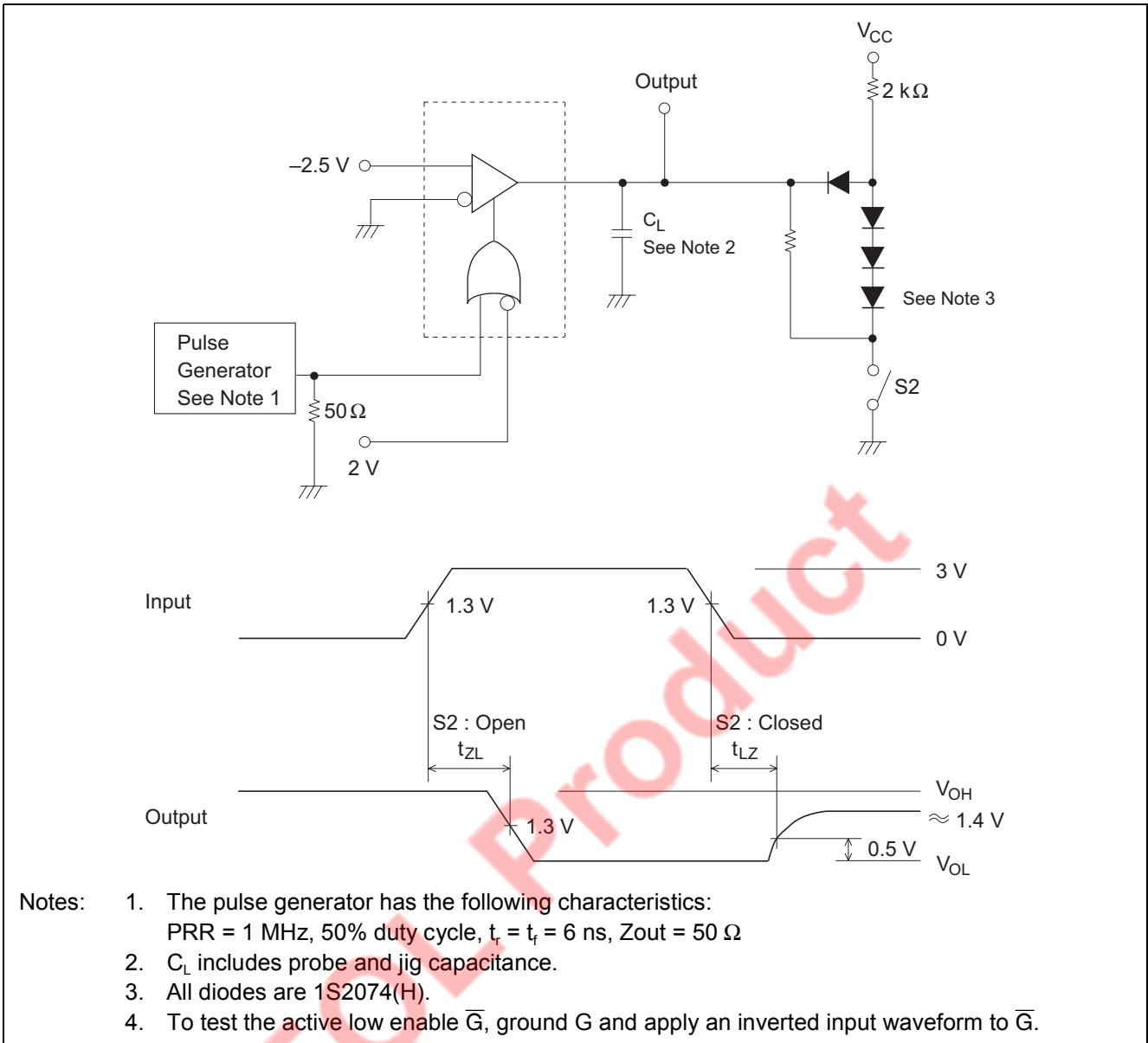

Package Dimensions

As of January, 2003  
Unit: mm

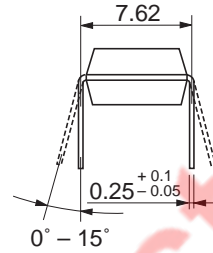
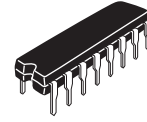
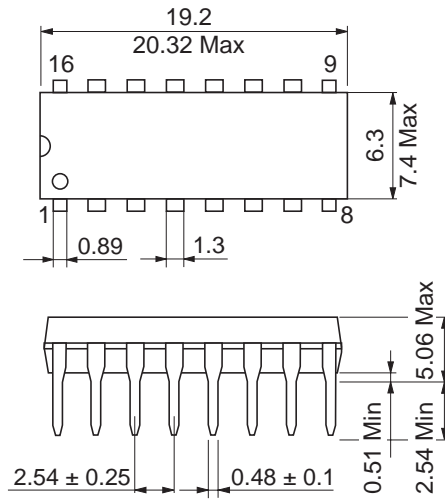

Package Code	DP-16E
JEDEC	Conforms
JEITA	Conforms
Mass (reference value)	1.05 g

Unit: mm

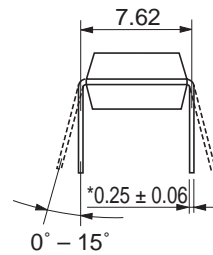
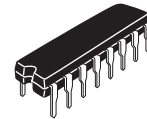
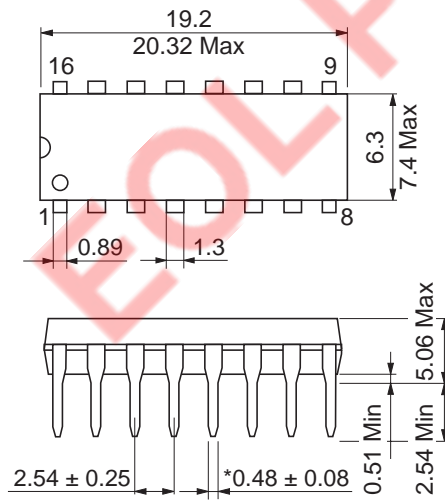

\*Ni/Pd/AU Plating

Package Code	DP-16FV
JEDEC	Conforms
JEITA	Conforms
Mass (reference value)	1.05 g

**Renesas Technology Corp.** Sales Strategic Planning Div. Nippon Bldg., 2-6-2, Ohte-machi, Chiyoda-ku, Tokyo 100-0004, Japan

---

Keep safety first in your circuit designs!

1. Renesas Technology Corp. puts the maximum effort into making semiconductor products better and more reliable, but there is always the possibility that trouble may occur with them. Trouble with semiconductors may lead to personal injury, fire or property damage. Remember to give due consideration to safety when making your circuit designs, with appropriate measures such as (i) placement of substitutive, auxiliary circuits, (ii) use of nonflammable material or (iii) prevention against any malfunction or mishap.

Notes regarding these materials

1. These materials are intended as a reference to assist our customers in the selection of the Renesas Technology Corp. product best suited to the customer's application; they do not convey any license under any intellectual property rights, or any other rights, belonging to Renesas Technology Corp. or a third party.
  2. Renesas Technology Corp. assumes no responsibility for any damage, or infringement of any third-party's rights, originating in the use of any product data, diagrams, charts, programs, algorithms, or circuit application examples contained in these materials.
  3. All information contained in these materials, including product data, diagrams, charts, programs and algorithms represents information on products at the time of publication of these materials, and are subject to change by Renesas Technology Corp. without notice due to product improvements or other reasons. It is therefore recommended that customers contact Renesas Technology Corp. or an authorized Renesas Technology Corp. product distributor for the latest product information before purchasing a product listed herein.  
The information described here may contain technical inaccuracies or typographical errors.  
Renesas Technology Corp. assumes no responsibility for any damage, liability, or other loss rising from these inaccuracies or errors.  
Please also pay attention to information published by Renesas Technology Corp. by various means, including the Renesas Technology Corp. Semiconductor home page (<http://www.renesas.com>).
  4. When using any or all of the information contained in these materials, including product data, diagrams, charts, programs, and algorithms, please be sure to evaluate all information as a total system before making a final decision on the applicability of the information and products. Renesas Technology Corp. assumes no responsibility for any damage, liability or other loss resulting from the information contained herein.
  5. Renesas Technology Corp. semiconductors are not designed or manufactured for use in a device or system that is used under circumstances in which human life is potentially at stake. Please contact Renesas Technology Corp. or an authorized Renesas Technology Corp. product distributor when considering the use of a product contained herein for any specific purposes, such as apparatus or systems for transportation, vehicular, medical, aerospace, nuclear, or undersea repeater use.
  6. The prior written approval of Renesas Technology Corp. is necessary to reprint or reproduce in whole or in part these materials.
  7. If these products or technologies are subject to the Japanese export control restrictions, they must be exported under a license from the Japanese government and cannot be imported into a country other than the approved destination.  
Any diversion or reexport contrary to the export control laws and regulations of Japan and/or the country of destination is prohibited.
  8. Please contact Renesas Technology Corp. for further details on these materials or the products contained therein.
- 



**RENESAS SALES OFFICES**

<http://www.renesas.com>

**Renesas Technology America, Inc.**

450 Holger Way, San Jose, CA 95134-1368, U.S.A  
Tel: <1> (408) 382-7500 Fax: <1> (408) 382-7501

**Renesas Technology Europe Limited.**

Dukes Meadow, Millboard Road, Bourne End, Buckinghamshire, SL8 5FH, United Kingdom  
Tel: <44> (1628) 585 100, Fax: <44> (1628) 585 900

**Renesas Technology Europe GmbH**

Dornacher Str. 3, D-85622 Feldkirchen, Germany  
Tel: <49> (89) 380 70 0, Fax: <49> (89) 929 30 11

**Renesas Technology Hong Kong Ltd.**

7/F., North Tower, World Finance Centre, Harbour City, Canton Road, Hong Kong  
Tel: <852> 2265-6688, Fax: <852> 2375-6836

**Renesas Technology Taiwan Co., Ltd.**

FL 10, #99, Fu-Hsing N. Rd., Taipei, Taiwan  
Tel: <886> (2) 2715-2888, Fax: <886> (2) 2713-2999

**Renesas Technology (Shanghai) Co., Ltd.**

26/F., Ruijin Building, No.205 Maoming Road (S), Shanghai 200020, China  
Tel: <86> (21) 6472-1001, Fax: <86> (21) 6415-2952

**Renesas Technology Singapore Pte. Ltd.**

1, Harbour Front Avenue, #06-10, Keppel Bay Tower, Singapore 098632  
Tel: <65> 6213-0200, Fax: <65> 6278-8001