

Description

The S33201M is operational amplifiers provide rail-to-rail operation on both the input and output. The inputs can be driven as high as 200mV beyond the supply rails without phase reversal on the outputs, and the output can swing within 50mV of each rail. This rail-to-rail operation enables the user to make full use of the supply voltage range available. It is designed to work at very low supply voltages (± 0.9 V) yet can operate with a supply of up to +12V and ground. Output current boosting techniques provide a high output current capability while keeping the drain current of the amplifier to a minimum. Also, the combination of low noise and distortion with a high slew rate and drive capability make this an ideal amplifier for audio applications.

Features

- Low Voltage, Single Supply Operation (+1.8 V and Ground to +12 V and Ground)
- Input Voltage Range Includes both Supply Rails
- Output Voltage Swings within 50 mV of both Rails
- No Phase Reversal on the Output for Over-driven Input Signals
- High Output Current ($I_{SC} = 30$ mA, Typ)
- Low Supply Current ($I_{CC} = 0.9$ mA, Typ)
- 600 Ω Output Drive Capability
- Typical Gain Bandwidth Product = 2.2 MHz

Applications

- Low cost general purpose applications
- A/D buffer
- Smart card readers
- Keyless entry
- Audio applications
- Hard disk drives
- Cellular phones
- DSP interface
- Portable test instruments
- Telephone systems
- Digital still cameras
- MP3 players

Ordering Information

Type NO.	Marking	Package Code
S33201M	332	SOT-25

Outline Dimensions unit : mm

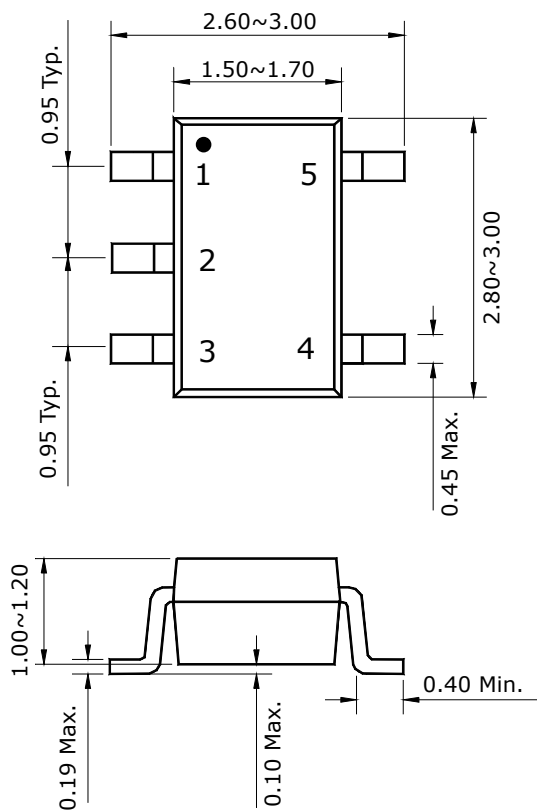

Internal Block

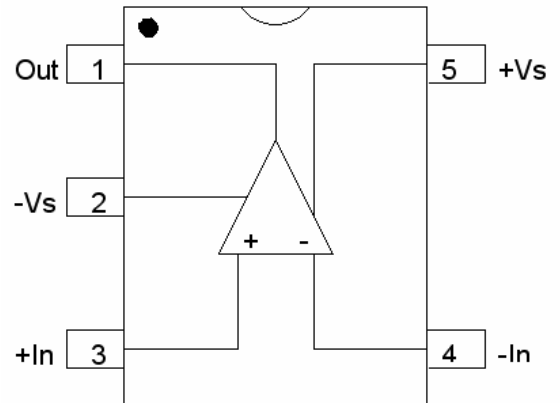

Circuit Schematic

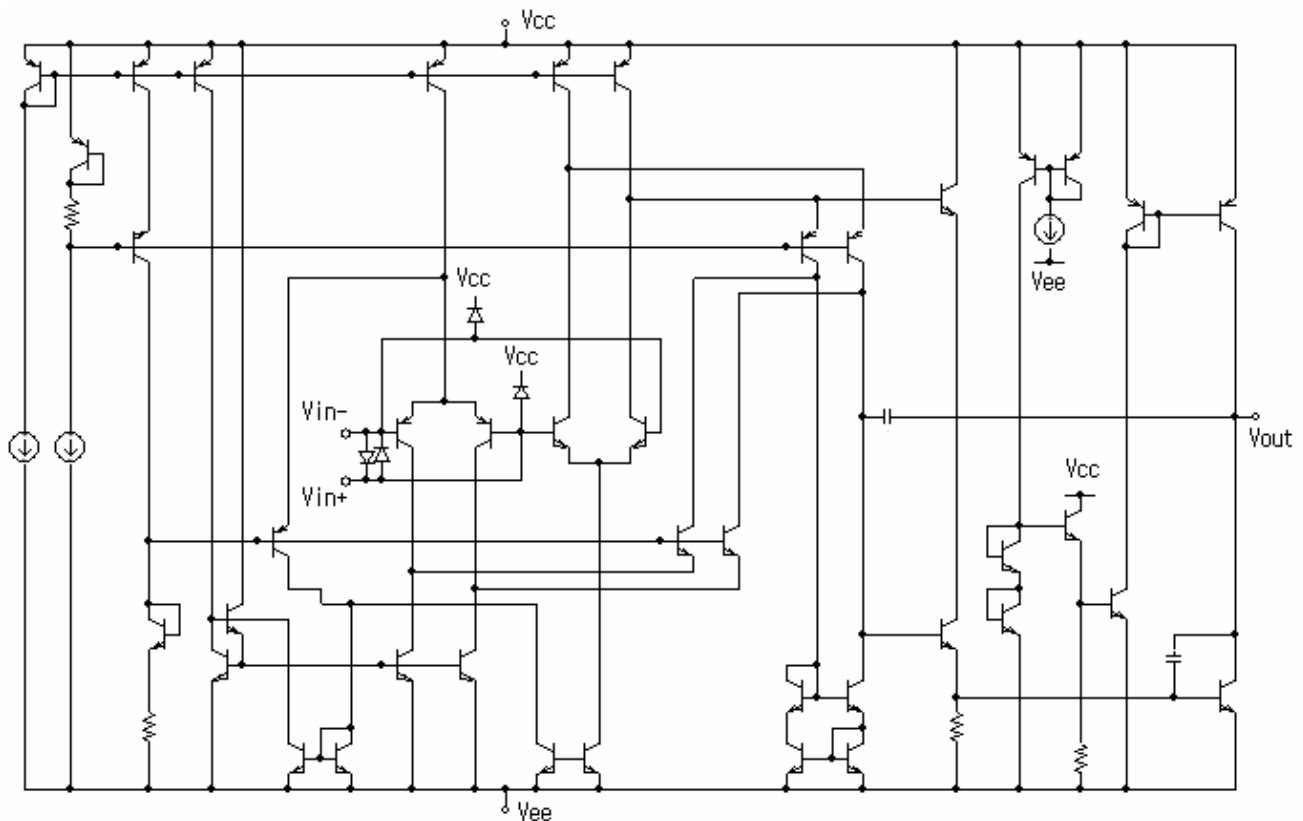

Absolute maximum ratings

Characteristic	Symbol	Rating	Unit
Supply Voltage (V_{CC} to V_{EE})	V_{CC}	+13	V
Input Differential Voltage Range	V_{IDR}	Note1	V
Common Mode Input Voltage Range (Note2)	V_{CM}	$V_{CC} + 0.5V$ to $V_{EE} - 0.5V$	V
Power Dissipation	P_D	0.5	W
Operating Ambient Temperature Range	T_{OPR}	-40 to 85	°C
Storage Temperature	T_{STG}	-55 to 150	°C

Notes ;

- The differential input voltage of each amplifier is limited by two internal parallel back-to-back diodes.
for additional differential input voltage range, use current limiting resistors in series with the input Pins.
- The input common mode voltage range is limited by internal diodes connected from the inputs to both supply rails. Therefore, the voltage on either input must not exceed either supply rail by more than 500mV.

Electrical Characteristics (Ta=25°C)

Characteristic		V_{CC} (V)			Unit
		2.0	3.3	5.0	
Output Voltage Swing (Note)	V_{OH} (Min)	1.9	3.15	4.85	V
	V_{OL} (Max)	0.10	0.15	0.15	V
Supply Current	I_{CC}	1.125	1.125	1.125	mA

Specifications at $V_{CC} = 3.3V$ are guaranteed by the 2.0V and 5.0V tests. $V_{EE} = GND$.

Note : ($R_L = 10\text{ k}\Omega$)

Electrical Characteristics

($V_{CC} = +5.0V$, $V_{EE} = GND$, Ta=25°C, unless otherwise noted.)

Characteristic	Symbol	Test Condition	Min.	Typ.	Max.	Unit
Input Offset Voltage	V_{IOS}	$V_{CM} = 0V$ to $0.5V$, $V_{CM} = 1.0V$ to $5.0V$	-	-	6	mV
Input Offset Voltage Temperature Coefficient	$\Delta V_{IO}/\Delta T$	$R_S = 50\Omega$	-	2	-	$\mu V/^\circ C$
Input Bias Current	I_{IB}	$V_{CM} = 0V$ to $0.5V$ $V_{CM} = 1.0V$ to $5.0V$	-	300	500	nA
Input Offset Current	I_{IO}	$V_{CM} = 0V$ to $0.5V$ $V_{CM} = 1.0V$ to $5.0V$	-	5	50	nA
Common Mode Input Voltage Range	V_{ICR}	-	V_{EE}	-	V_{CC}	V

Electrical Characteristics (cont.)(V_{CC} = +5.0V, V_{EE} = GND, T_a = 25°C, unless otherwise noted.)

Characteristic	Symbol	Test Condition	Min.	Typ.	Max.	Unit	
Large Signal Voltage Gain (V _{CC} =+5V, V _{EE} =-5V)	A _{VOL}	R _L =10 kΩ	50	300	-	kV/V	
		R _L =600Ω	25	250	-	kV/V	
Output Voltage Swing (V _{ID} =±0.2V)	V _{OH}	R _L =10 kΩ	4.85	4.95	-	V	
		R _L =600Ω	4.75	4.85	-	V	
	V _{OL}	R _L =10 kΩ	-	0.05	0.15	v	
		R _L =600Ω	-	0.15	0.25	V	
Common Mode Rejection	CMR	(V _{IN} = 0V to 5.0V)	60	90	-	dB	
Power Supply Rejection Ratio	PSRR	V _{CC} /V _{EE} = 5.0V/GND to 3.0V/GND	60	90	-	dB	
Output Short Circuit Current	Source Current	I _{SO}	-	20	30	-	mA
	Sink Current	I _{SI}	-	10	20	-	mA
Supply Current	I _{CC}	-	-	0.9	1.5	mA	
Slew Rate	SR	(V _S =±2.5V, V _O =-2.0V to 2.0V, R _L =2 kΩ, A _V =1)	-	1	-	V/μs	
Gain Bandwidth Product	GBW	-	-	2.2	-	MHz	

Electrical Characteristic Curves

Fig. 1 I_{CC} vs V_{CC}

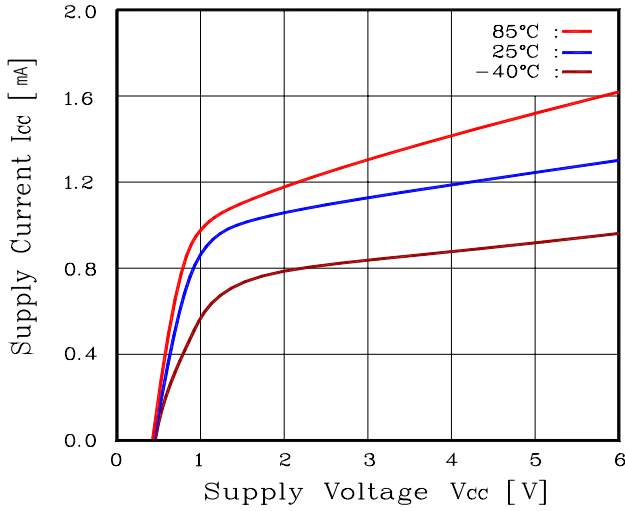

Fig. 2 I_{IB} vs V_{CC}

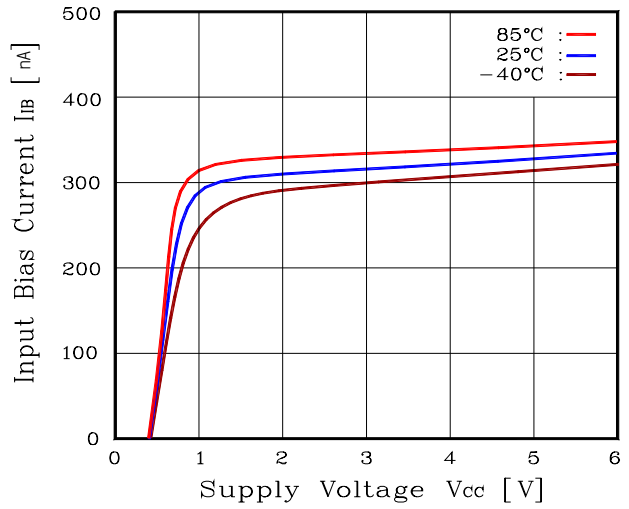

Fig. 3 V_{OH} vs V_{CC}

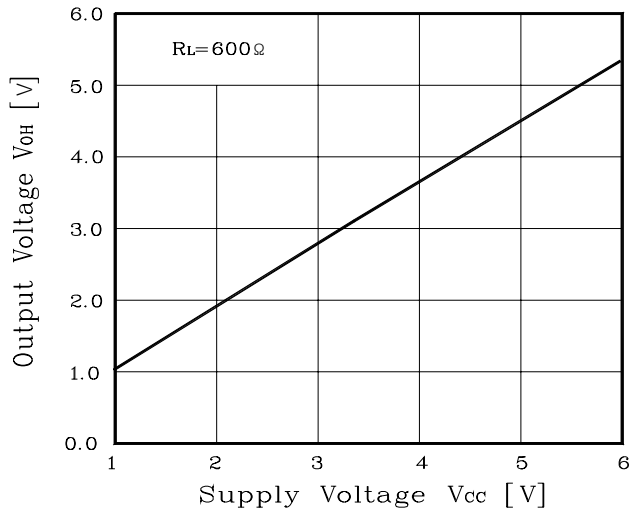

Fig. 4 V_{OL} vs V_{CC}

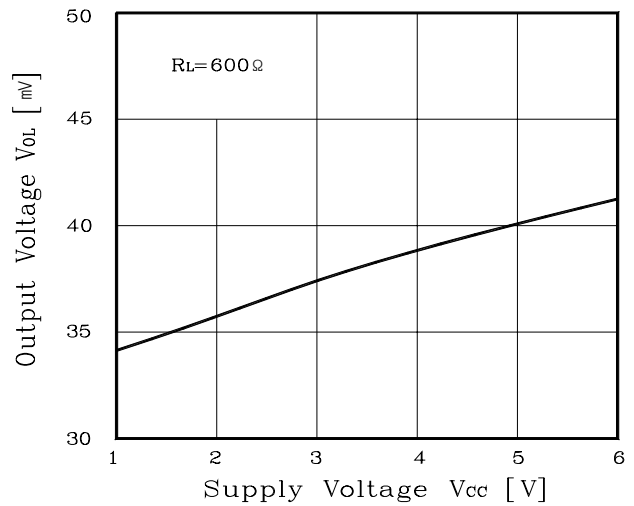

Fig. 5 V_{OP-P} vs f

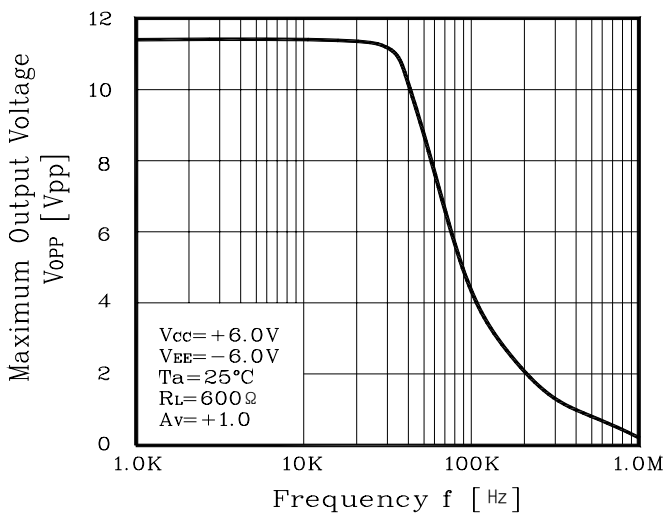

Fig. 6 CMR vs f

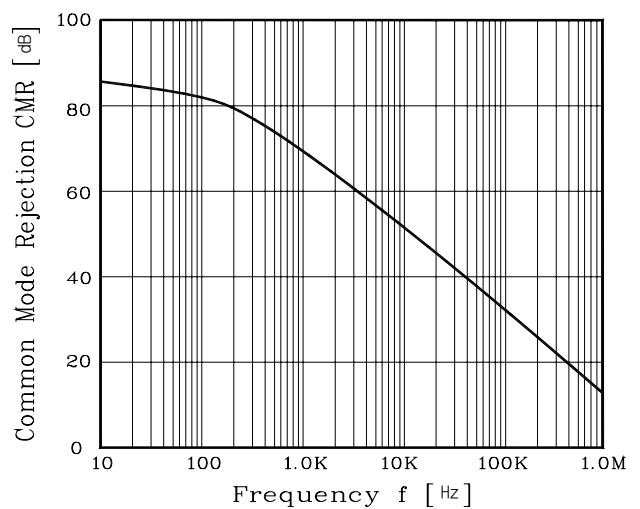

Fig. 7 I_{SC} vs V_{OUT}

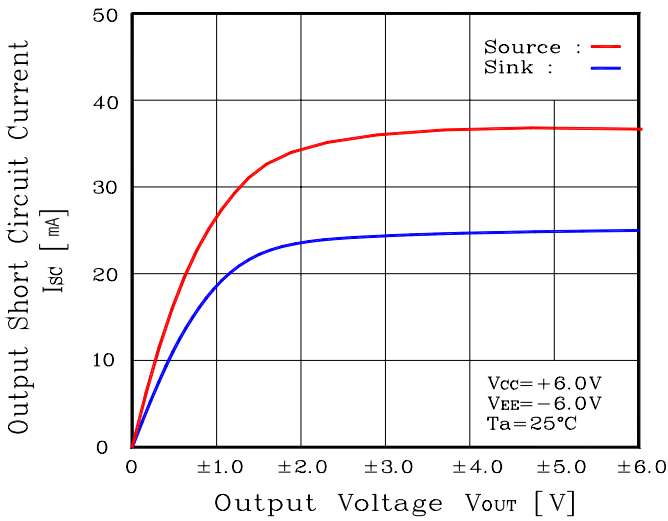
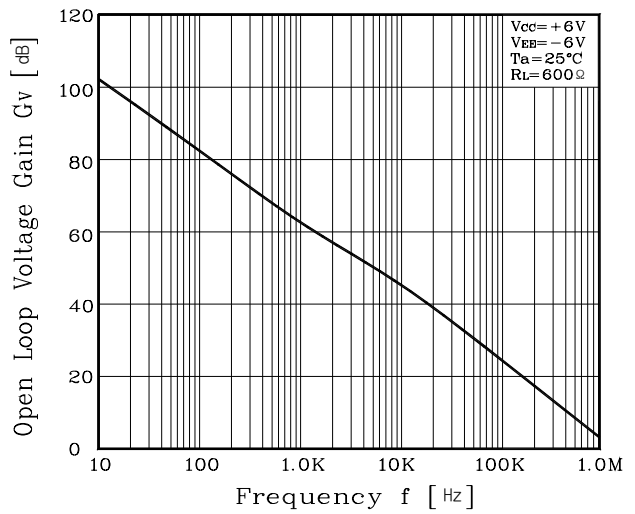

Fig. 8 G_V vs f



The AUK Corp. products are intended for the use as components in general electronic equipment (Office and communication equipment, measuring equipment, home appliance, etc.).

Please make sure that you consult with us before you use these AUK Corp. products in equipments which require high quality and / or reliability, and in equipments which could have major impact to the welfare of human life(atomic energy control, airplane, spaceship, transportation, combustion control, all types of safety device, etc.). AUK Corp. cannot accept liability to any damage which may occur in case these AUK Corp. products were used in the mentioned equipments without prior consultation with AUK Corp..

Specifications mentioned in this publication are subject to change without notice.