

# Precision Low Drift Low Noise Buffered Reference

## FEATURES

- **Low Drift: A Grade 5ppm/°C Max**  
           **B Grade 10ppm/°C Max**
- **High Accuracy: A Grade ±0.05%, B Grade ±0.1%**
- **Low Noise: 2ppm<sub>p-p</sub> (0.1Hz to 10Hz)**
- **Fully Specified Over -40°C to 125°C Temperature Range**
- Sinks and Sources Current: ±5mA
- Low Power Shutdown: <2μA Maximum
- Low Dropout: 300mV
- No External Load Capacitor Required
- Wide Supply Range to 13.2V
- 8-Lead MSOP Package

## APPLICATIONS

- Automotive Control and Monitoring
- High Temperature Industrial
- High Resolution Data Acquisition Systems
- Instrumentation and Process Control
- Precision Regulators
- Medical Equipment

## DESCRIPTION

The LTC®6652 is a precision, low drift, low noise reference that is fully specified over the -40°C to 125°C temperature range, making it an ideal choice for automotive or high temperature applications. High order curvature compensation allows this reference to achieve a low drift of less than 5ppm/°C with a predictable temperature characteristic and an output voltage accuracy of ±0.05%

The LTC6652 low dropout series reference can be powered from a 13.2V supply and run down to 300mV above the output voltage. The LTC6652 reference comes in an MSOP package. It boasts low noise, excellent load regulation, source and sink capabilities and exceptional line rejection, making it a superior choice for demanding precision applications. It also has a shutdown mode for low power applications and no output capacitor is required.

LT, LTC and LTM are registered trademarks of Linear Technology Corporation. All other trademarks are the property of their respective owners.

## TYPICAL APPLICATION

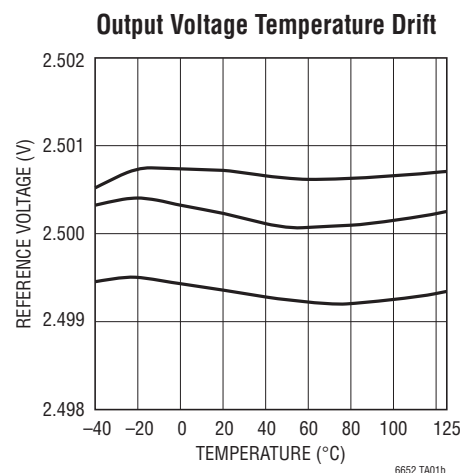
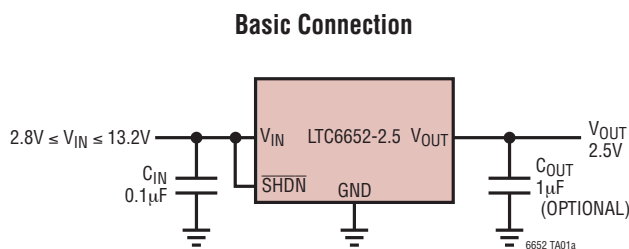

## ABSOLUTE MAXIMUM RATINGS

(Note 1)

Input Voltage

$V_{IN}$  to GND ..... -0.3V to 13.2V

$\overline{SHDN}$  to GND ..... -0.3V to ( $V_{IN} + 0.3V$ )

Output Voltage

$V_{OUT}$  ..... -0.3V to ( $V_{IN} + 0.3V$ )

Output Short-Circuit Duration ..... Indefinite

Operating Temperature Range ..... -40°C to 125°C

Storage Temperature Range (Note 2) ..... -65°C to 150°C

Lead Temperature Range (Soldering, 10 sec) ..... 300°C

## PIN CONFIGURATION

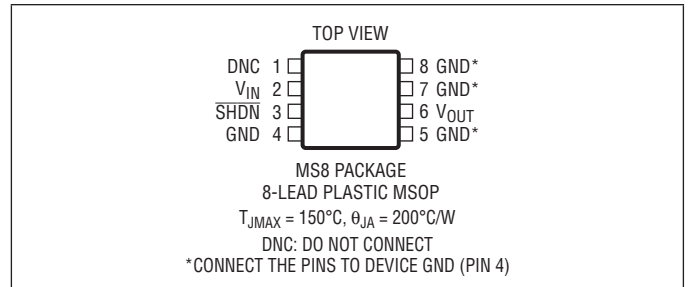

## ORDER INFORMATION

LEAD FREE FINISH	TAPE AND REEL	PART MARKING*	PACKAGE DESCRIPTION	TEMPERATURE RANGE
LTC6652AHMS8-2.5#PBF	LTC6652AHMS8-2.5#TRPBF	LTCQV	8-Lead Plastic MSOP	-40°C to 125°C
LTC6652BHMS8-2.5#PBF	LTC6652BHMS8-2.5#TRPBF	LTCQV	8-Lead Plastic MSOP	-40°C to 125°C

Consult LTC Marketing for parts specified with wider operating temperature ranges. \*The temperature grade is identified by a label on the shipping container. Consult LTC Marketing for information on non-standard lead based finish parts.

For more information on lead free part marking, go to: <http://www.linear.com/leadfree/>

For more information on tape and reel specifications, go to: <http://www.linear.com/tapeandreeel/>

## AVAILABLE OPTIONS

OUTPUT VOLTAGE	INITIAL ACCURACY	TEMPERATURE COEFFICIENT	ORDER PART NUMBER
2.500	0.05% 0.1%	5ppm/°C 10ppm/°C	LTC6652AHMS8-2.5 LTC6652BHMS8-2.5

Note: Other voltage options are in development. Consult factory for status.

## ELECTRICAL CHARACTERISTICS

The ● denotes the specifications which apply over the full operating temperature range, otherwise specifications are at  $T_A = 25^\circ\text{C}$ ,  $V_{IN} = V_{OUT} + 0.5\text{V}$ , unless otherwise noted.

PARAMETER	CONDITIONS	MIN	TYP	MAX	UNITS
Output Voltage	LTC6652A	-0.05		0.05	%
	LTC6652B	-0.1		0.1	%
Output Voltage Temperature Coefficient (Note 3)	LTC6652A	●	2	5	ppm/°C
	LTC6652B	●	4	10	ppm/°C
Line Regulation	$V_{OUT} + 0.5\text{V} \leq V_{IN} \leq 13.2\text{V}$ , $\overline{\text{SHDN}} = V_{IN}$	●	2	50 80	ppm/V ppm/V
Load Regulation (Note 4)	$I_{\text{SINK}} = 5\text{mA}$	●	50	150 450	ppm/mA ppm/mA
	$I_{\text{SOURCE}} = 5\text{mA}$	●	20	75 200	ppm/mA ppm/mA
Minimum Operating Voltage (Note 5)	$I_{\text{OUT}} = 5\text{mA}$ , $V_{\text{OUT}} \text{ Error} \leq 0.1\%$	●	2.8		V
Output Short-Circuit Current	Short $V_{\text{OUT}}$ to GND		16		mA
	Short $V_{\text{OUT}}$ to $V_{\text{IN}}$		16		mA
Shutdown Pin ( $\overline{\text{SHDN}}$ )	Logic High Input Voltage	●	2		V
	Logic High Input Current	●	0.1	1	$\mu\text{A}$
	Logic Low Input Voltage	●		0.8	V
	Logic Low Input Current	●	0.1	1	$\mu\text{A}$
Supply Current	No Load	●	350		$\mu\text{A}$
		●		560	$\mu\text{A}$
Shutdown Current		●	0.1	2	$\mu\text{A}$
Output Voltage Noise (Note 6)	$0.1\text{Hz} \leq f \leq 10\text{Hz}$		2		ppm <sub>P-P</sub>
	$10\text{Hz} \leq f \leq 1\text{kHz}$		3		ppm <sub>RMS</sub>
Turn-On Time	0.1% Settling		40		$\mu\text{s}$
Long Term Drift of Output Voltage (Note 7)			60		ppm/ $\sqrt{\text{kHz}}$
Hysteresis (Note 8)	$\Delta T = -40^\circ\text{C}$ to $125^\circ\text{C}$		105		ppm

**Note 1:** Stresses beyond those listed under Absolute Maximum Ratings may cause permanent damage to the device. Exposure to any Absolute Maximum Rating condition for extended periods may affect device reliability and lifetime.

**Note 2:** If the parts are stored outside of the specified temperature range, the output may shift due to hysteresis.

**Note 3:** Temperature coefficient is measured by dividing the max change in output voltage by the specified temperature range.

**Note 4:** Load regulation is measured on a pulse basis from no load to the specified load current. Output changes due to die temperature change must be taken into account separately.

**Note 5:** Excludes load regulation errors.

**Note 6:** Peak-to-peak noise is measured with a 3-pole highpass at 0.1Hz and 4-pole lowpass filter at 10Hz. The unit is enclosed in a still-air environment to eliminate thermocouple effects on the leads. The test time is 10 seconds. RMS noise is measured on a spectrum analyzer in a shielded environment where the intrinsic noise of the instrument is removed to determine the actual noise of the device.

**Note 7:** Long term stability typically has a logarithmic characteristic and therefore, changes after 1000 hours tend to be much smaller than before that time. Total drift in the second thousand hours is normally less than one third that of the first thousand hours with a continuing trend toward reduced drift with time. Long-term stability will also be affected by differential stresses between the IC and the board material created during board assembly.

**Note 8:** Hysteresis in output voltage is created by package stress that differs depending on whether the IC was previously at a higher or lower temperature. Output voltage is always measured at  $25^\circ\text{C}$ , but the IC is cycled to the hot or cold temperature limit before successive measurements. Hysteresis is roughly proportional to the square of the temperature change. For instruments that are stored at well controlled temperatures (within 20 or 30 degrees of operational temperature) it's usually not a dominant error source.

## TYPICAL PERFORMANCE CHARACTERISTICS

**Output Voltage Temperature Drift**

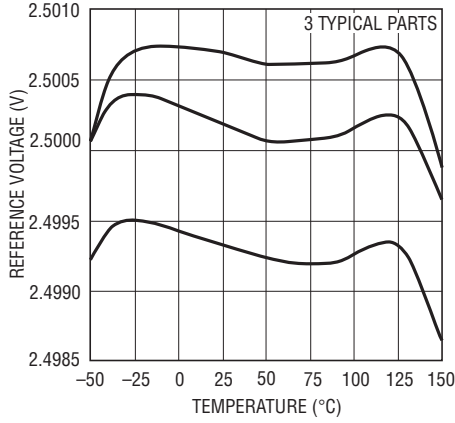

6652 G01

**Line Regulation**

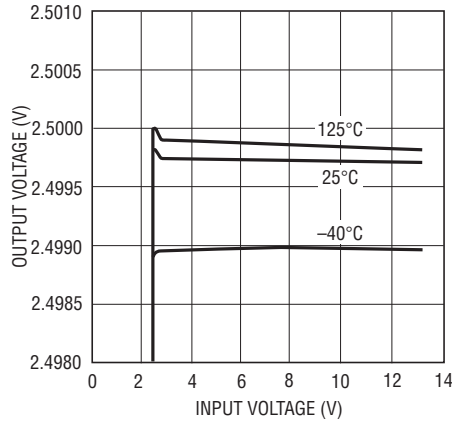

6652 G02

**Load Regulation (Sourcing)**

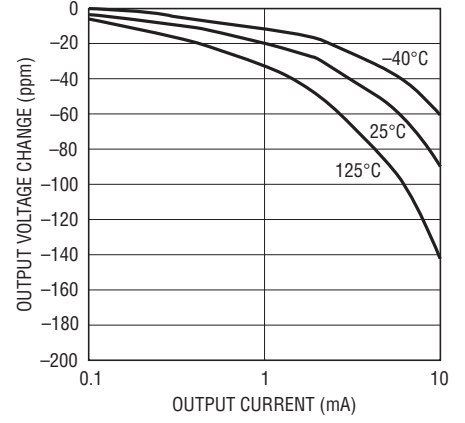

6652 G03

**Load Regulation (Sinking)**

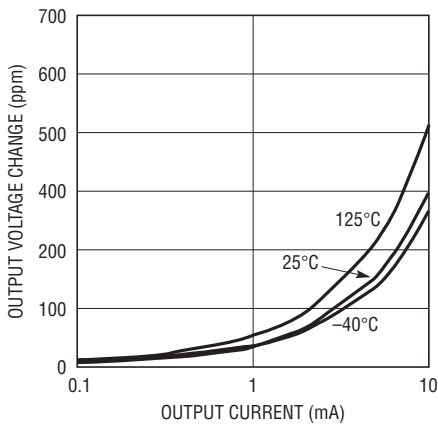

6652 G04

**Supply Current vs Input Voltage**

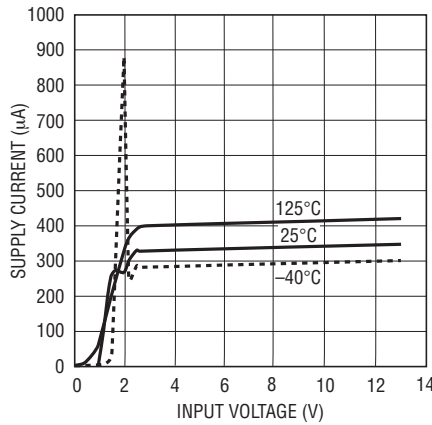

LTC1323 • 1PC05

**Shutdown Current vs Supply Voltage**

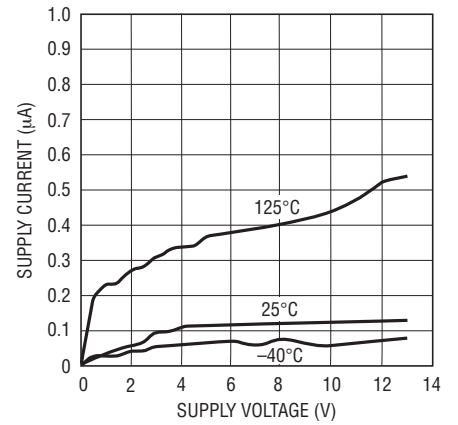

6652 G06

**Power Supply Rejection Ratio vs Frequency**

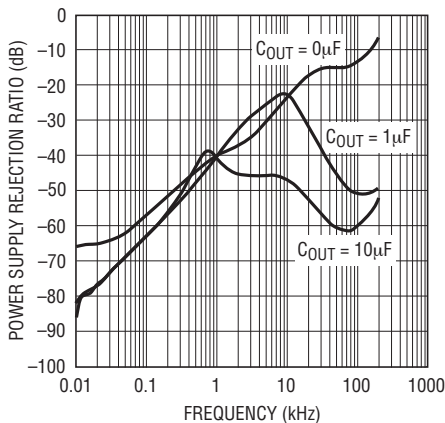

6652 G07

**Output Impedance vs Frequency**

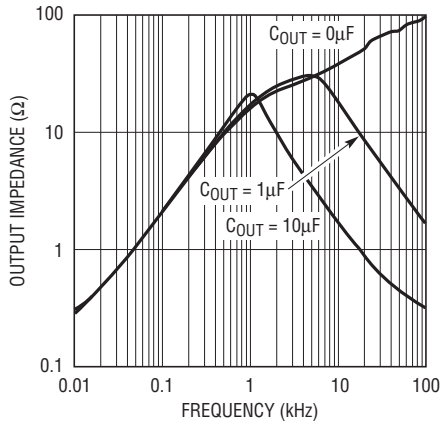

6652 G08

**Minimum  $V_{IN}-V_{OUT}$  Differential (Sourcing)**

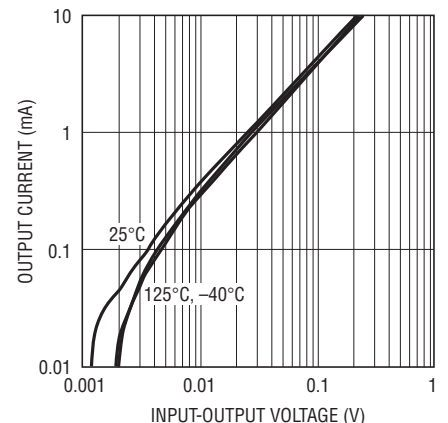

6652 G09

6652f

# TYPICAL PERFORMANCE CHARACTERISTICS

**Minimum  $V_{OUT}-V_{IN}$  Differential (Sinking)**

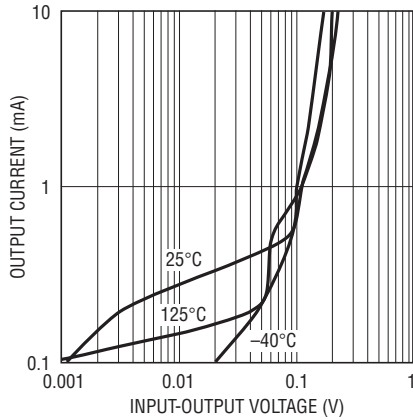

6652 G10

**Low Frequency 0.1Hz to 10Hz Transient Noise**

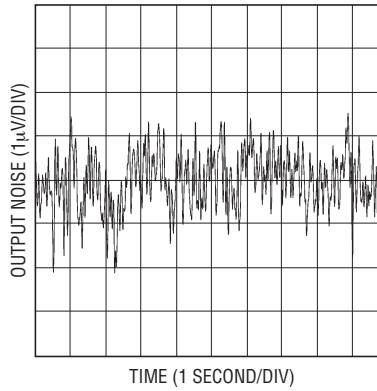

6652 G11

**Output Voltage Noise Spectrum**

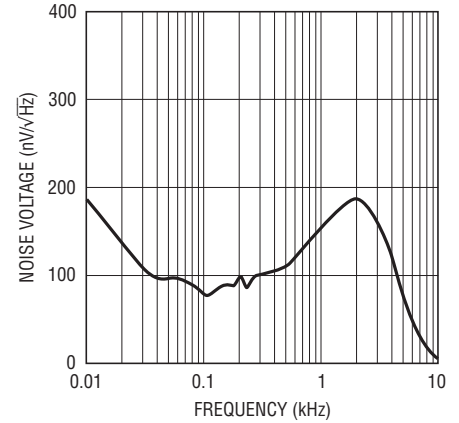

6652 G12

**Typical  $V_{OUT}$  Distribution for LTC6652-2.5**

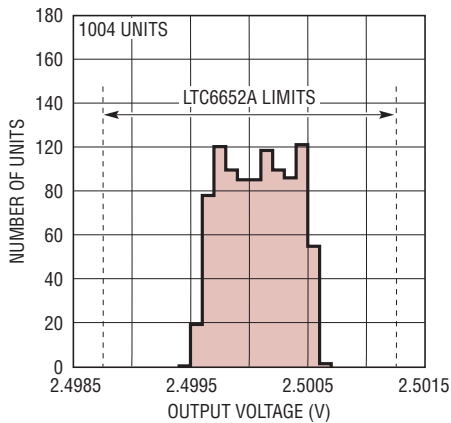

6652 G15

**LTC6652-2.5 Stability with Output Capacitance**

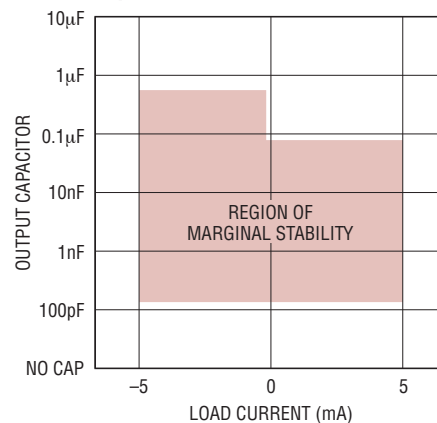

6652 G14

**SHDN Input Voltage Thresholds vs  $V_{IN}$**

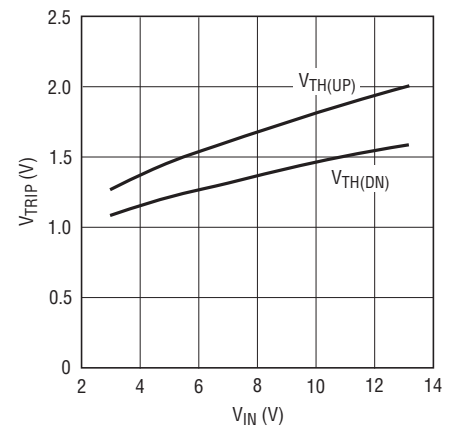

6652 G13

## PIN FUNCTIONS

**DNC (Pin 1):** Do Not Connect.

**$V_{IN}$  (Pin 2):** Power Supply. The minimum supply input is 2.8V. The maximum supply is 13.2V. Bypassing  $V_{IN}$  with a 0.1 $\mu$ F capacitor to GND will improve PSRR.

**$\overline{\text{SHDN}}$  (Pin 3):** Shutdown Input. This active low input powers down the device to <2 $\mu$ A. For normal operation tie this pin to  $V_{IN}$ .

**GND (Pin 4):** Device Ground.

**$V_{OUT}$  (Pin 6):** Output Voltage. An output capacitor is not required. For some applications, a capacitor between 0.1 $\mu$ F to 10 $\mu$ F can be beneficial. See the graphs in the Typical Performance Characteristics section for further details.

**GND (Pins 5, 7, 8):** Internal function. Ground this pin.

## BLOCK DIAGRAM

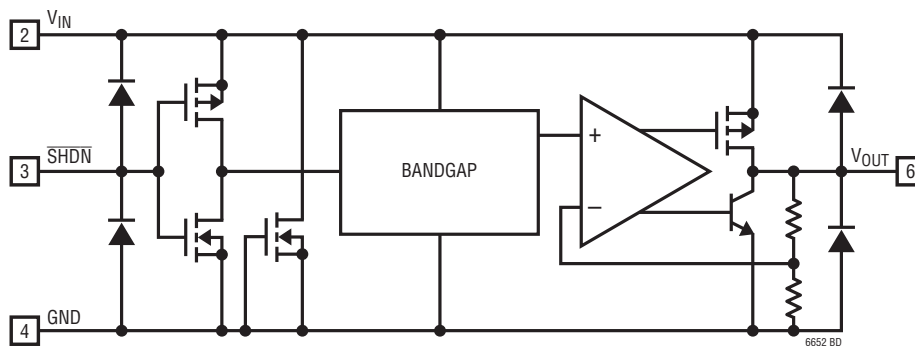

## APPLICATIONS INFORMATION

### Bypass and Load Capacitors

The LTC6652 voltage reference does not require an input capacitor, but a 0.1 $\mu$ F capacitor located close to the part improves power supply rejection.

The LTC6652 voltage reference is stable with or without a capacitive load. For applications where an output capacitor is beneficial, a value of 0.1 $\mu$ F to 10 $\mu$ F is recommended depending on load conditions. The Typical Performance Characteristics section includes a plot illustrating a region of marginal stability. Either no or low value capacitors for any load current are acceptable. For loads that sink current or light loads that source current, a 0.1 $\mu$ F to 10 $\mu$ F capacitor has stable operation. For heavier loads that source current a 0.5 $\mu$ F to 10 $\mu$ F capacitor range is recommended.

The transient response for a 0.5V step on  $V_{IN}$  with and without an output capacitor is shown in Figures 2 and 3, respectively.

The LTC6652-2.5 voltage reference is guaranteed to source and sink up to 5mA. The test circuit for transient load step response is shown in Figure 1. Figures 4 and 5 show a 5mA source and sink load step response without a load capacitor, respectively.

### Start-Up

The start-up characteristic of the LTC6652 is shown in Figures 8 and 9. Note that the turn-on time is affected by the value of the output capacitor.

# APPLICATIONS INFORMATION

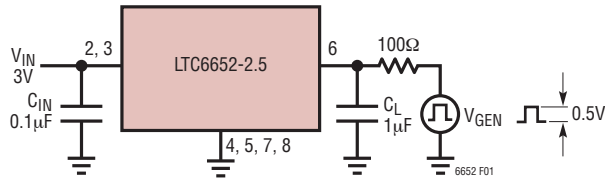

Figure 1. Transient Load Test Circuit

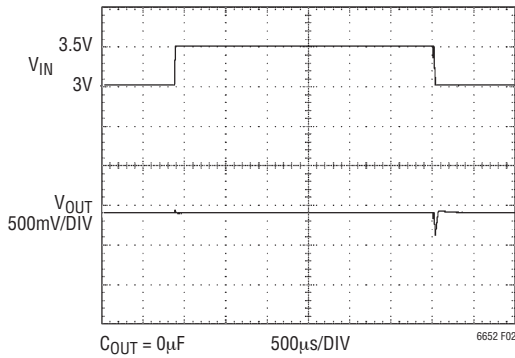

Figure 2. Transient Response Without Output Capacitor

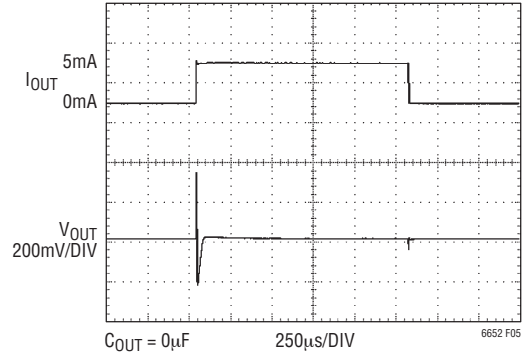

Figure 5. LTC6652-2.5 Sinking Current Without Output Capacitor

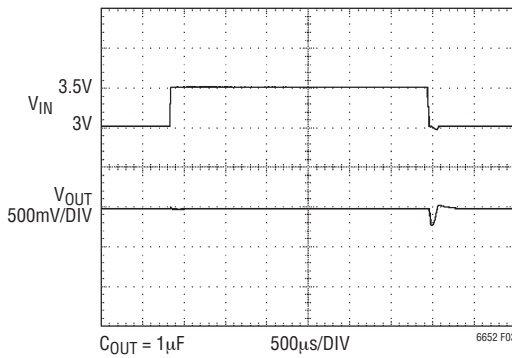

Figure 3. Transient Response with 1µF Output Capacitor

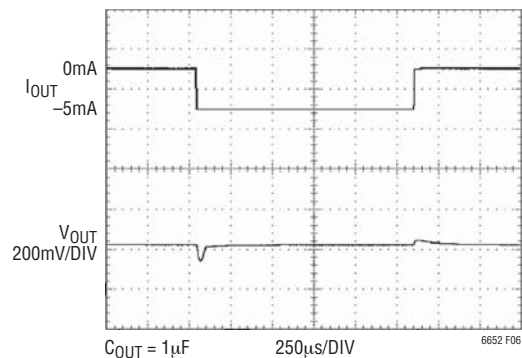

Figure 6. LTC6652-2.5 Sourcing Current with Output Capacitor

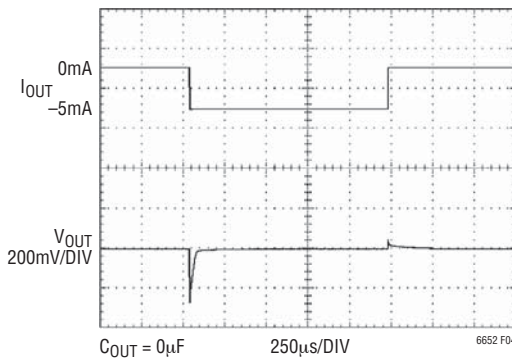

Figure 4. LTC6652-2.5 Sourcing Current Without Output Capacitor

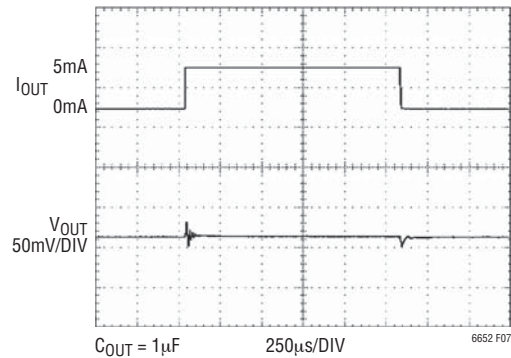

Figure 7. LTC6652-2.5 Sinking Current with Output Capacitor

## APPLICATIONS INFORMATION

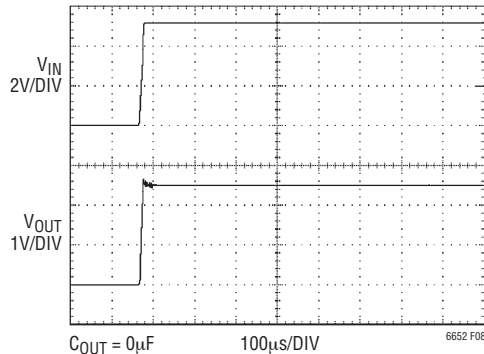

Figure 8. Start-Up Response Without Output Capacitor

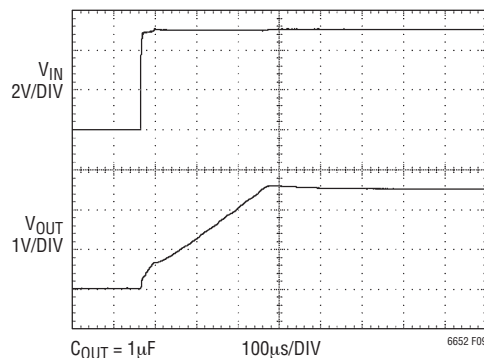

Figure 9. Start-Up Response with 1µF Output Capacitor

In Figure 8, ripple momentarily appears just after the leading edge of powering on. This brief one time event is caused by calibration circuitry during initialization. When an output capacitor is used, the ripple is virtually undetectable as shown in Figure 9.

### Shutdown Mode

Shutdown mode is enabled by tying  $\overline{\text{SHDN}}$  low which places the part in a low power state (i.e.,  $<2\mu\text{A}$ ). In shutdown mode, the output pin takes the value of  $50\text{k}\Omega$ . For normal operation,  $\overline{\text{SHDN}}$  should be greater than or equal to  $2.0\text{V}$ . For use with a microcontroller, use a pull-up resistor to  $V_{\text{IN}}$  and an open-drain output driver as shown in Figure 10. The LTC6652's response into and out of shutdown mode is shown in Figure 11.

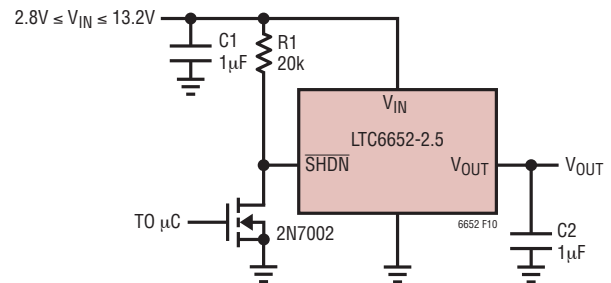

Figure 10. Open-Drain Shutdown Circuit

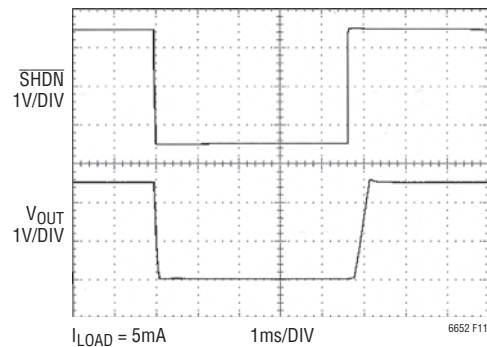

Figure 11. Shutdown Response with 5mA Load

The trip thresholds on  $\overline{\text{SHDN}}$  have some dependence on the voltage applied to  $V_{\text{IN}}$  as shown in the Typical Performance Characteristics section. Be careful to avoid leaving  $\overline{\text{SHDN}}$  at a voltage between the thresholds as this will likely cause an increase in supply current due to shoot-through current.

### Long-Term Drift

**Long-term drift cannot be extrapolated from accelerated high temperature testing. This erroneous technique gives drift numbers that are wildly optimistic. The only way long-term drift can be determined is to measure it over the time interval of interest.** The LTC6652 long-term drift data was collected on more than 100 parts that were soldered into PC boards similar to a “real world” application. The boards were then placed into a constant temperature oven with  $T_A = 33^\circ\text{C}$ , their outputs were scanned regularly and measured with an 8.5 digit DVM. Long-term drift is shown below in Figure 12.



## APPLICATIONS INFORMATION

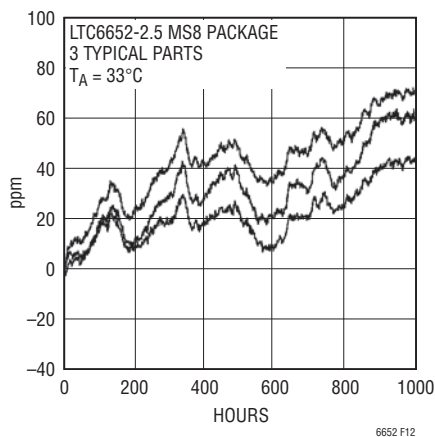

Figure 12. Long Term Drift

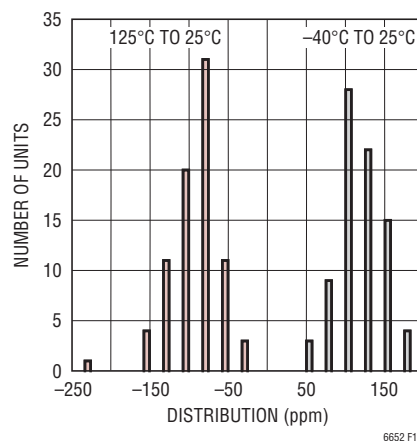

Figure 13. Hysteresis Plot  $-40^{\circ}\text{C}$  to  $125^{\circ}\text{C}$

### Hysteresis

The hysteresis data shown in Figure 13 represents the worst-case data collected on parts from  $-40^{\circ}\text{C}$  to  $125^{\circ}\text{C}$ . The output is capable of dissipating relatively high power, i.e., for the LTC6652-2.5,  $P_D = 10.7\text{V} \cdot 5.5\text{mA} = 58.85\text{mW}$ . The thermal resistance of the MS8 package is  $200^{\circ}\text{C}/\text{W}$  and this dissipation causes a  $11.8^{\circ}\text{C}$  internal rise. This could increase the junction temperature above  $125^{\circ}\text{C}$  and may cause the output to shift due to thermal hysteresis.

### PC Board Layout

The mechanical stress of soldering a surface mount voltage reference to a PC board can cause the output voltage to shift and temperature coefficient to change. These two changes are not correlated. For example, the voltage may shift, but the temperature coefficient may not.

To reduce the effects of stress-related shifts, mount the reference near the short edge of the PC board or in a corner. In addition, slots can be cut into the board on two sides of the device.

The capacitors should be mounted close to the package. The GND and  $V_{\text{OUT}}$  traces should be as short as possible to minimize  $I \cdot R$  drops. Excessive trace resistance directly impacts load regulation.

### Power Dissipation

Power dissipation in the LTC6652 is dependent on  $V_{\text{IN}}$ , load current, and package. The LTC6652 package has a thermal resistance, or  $\theta_{\text{JA}}$ , of  $200^{\circ}\text{C}/\text{W}$ . A curve that illustrates allowed power dissipation vs temperature for this package is shown in Figure 14.

The power dissipation of the LTC6652-2.5V as a function of input voltage is shown in Figure 15. The top curve shows power dissipation with a 5mA load and the bottom curve shows power dissipation with no load.

When operated within its specified limits of  $V_{\text{IN}} = 13.2\text{V}$  and sourcing 5mA, the LTC6652-2.5 consumes just under 60mW at room temperature. At  $125^{\circ}\text{C}$  the quiescent current will be slightly higher and the power consumption increases to just over 60mW. The power-dereating curve in Figure 14 shows the LTC6652-2.5 can safely dissipate 125mW at  $125^{\circ}\text{C}$  about half the maximum power consumption of the package.

## APPLICATIONS INFORMATION

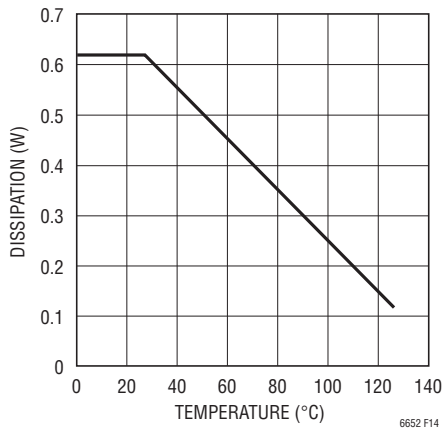

Figure 14. Maximum Recommended Dissipation for LTC6652

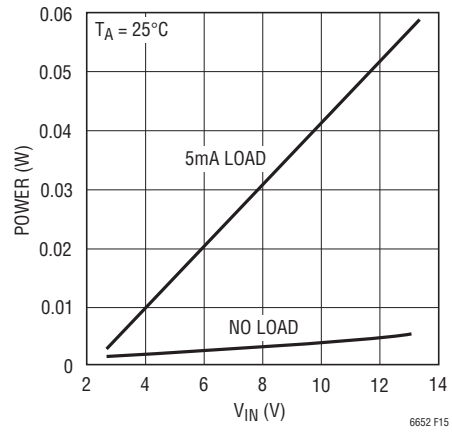
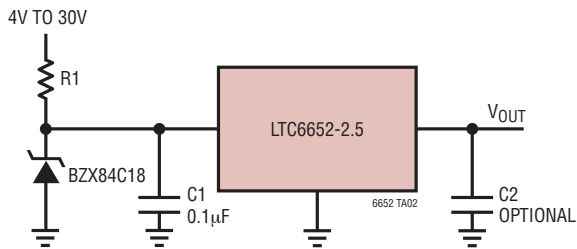

Figure 15. Typical Power Dissipation of the LTC6652

## TYPICAL APPLICATIONS

### Extended Supply Range Reference



### Extended Supply Range Reference

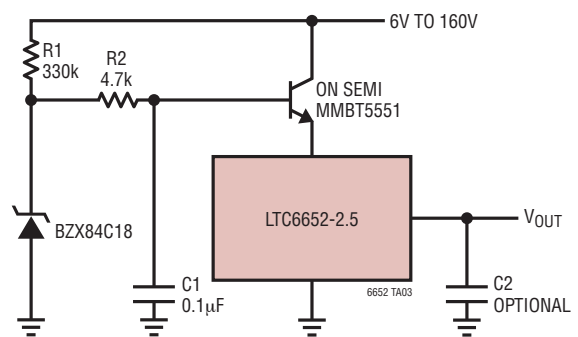

### Boosted Output Current

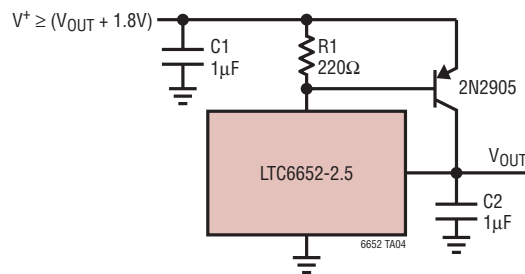

## PACKAGE DESCRIPTION

MS8 Package  
8-Lead Plastic MSOP

(Reference LTC DWG # 05-08-1660 Rev F)

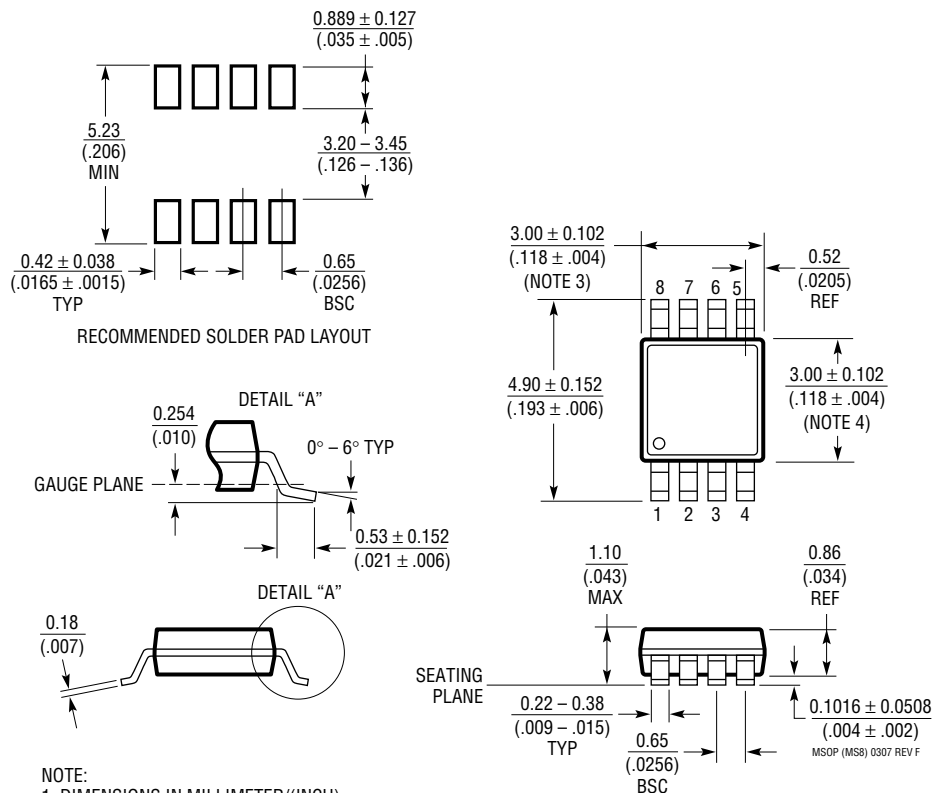

## NOTE:

1. DIMENSIONS IN MILLIMETER/(INCH)
2. DRAWING NOT TO SCALE
3. DIMENSION DOES NOT INCLUDE MOLD FLASH, PROTRUSIONS OR GATE BURRS.  
MOLD FLASH, PROTRUSIONS OR GATE BURRS SHALL NOT EXCEED 0.152mm (.006") PER SIDE
4. DIMENSION DOES NOT INCLUDE INTERLEAD FLASH OR PROTRUSIONS.  
INTERLEAD FLASH OR PROTRUSIONS SHALL NOT EXCEED 0.152mm (.006") PER SIDE
5. LEAD COPLANARITY (BOTTOM OF LEADS AFTER FORMING) SHALL BE 0.102mm (.004") MAX

## TYPICAL APPLICATION

### Improved Reference Supply Rejection in a Data Converter Application

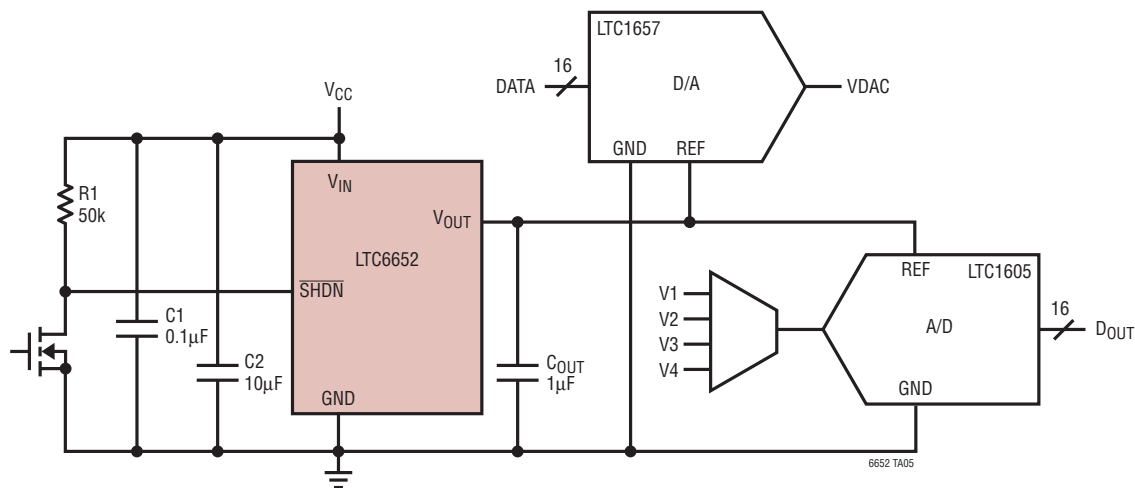

## RELATED PARTS

PART NUMBER	DESCRIPTION	COMMENTS
LT1460	Micropower Series References	0.075% Max, 10ppm/°C Max, 20mA Output Current
LT1461	Micropower Series Low Dropout	0.04% Max, 3ppm/°C Max, 50mA Output Current
LT1790	Micropower Precision Series References	0.05% Max, 10ppm/°C Max, 60µA Supply, SOT23 Package
LT6650	Micropower Reference with Buffer Amplifier	0.5% Max, 5.6µA Supply, SOT23 Package
LT6660	Tiny Micropower Series Reference	0.2% Max, 20ppm/°C Max, 20mA Output Current, 2mm × 2mm DFN