

December 1992

CMOS BCD-To-Decimal Decoder

Features

- High Voltage Type (20V Rating)
- BCD-to-Decimal Decoding or Binary-to-Octal Decoding
- High Decoded Output Drive Capability
- "Positive Logic" Inputs and Outputs - Decoded Outputs Go High On Selection
- Medium-Speed Operation
 - $t_{PHL}, t_{PLH} = 80\text{ns}$ (typ) at $V_{DD} = 10\text{V}$
- Standardized Symmetrical Output Characteristics
- 100% Tested For Quiescent Current at 20V
- Maximum Input Current of $1\mu\text{A}$ at 18V Over Full Package-Temperature Range;
 - 100nA at 18V and $+25^\circ\text{C}$
- Noise Margin (Over Full Package Temperature Range):
 - 1V at $V_{DD} = 5\text{V}$
 - 2V at $V_{DD} = 10\text{V}$
 - 2.5V at $V_{DD} = 15\text{V}$
- 5V, 10V and 15V Parametric Ratings
- Meets All Requirements of JEDEC Tentative Standard No. 13B, "Standard Specifications for Description of 'B' Series CMOS Devices"

Applications

- Code Conversion
- Indication-Tube Decoder
- Address Decoding - Memory Selection Control

Description

CD4028BMS types are BCD-to-decimal or binary-to-octal decoders consisting of buffering on all 4 inputs, decoding logic gates, and 10 output buffers. A BCD code applied to the four inputs, A to D, results in a high level at the selected one of 10 decimal decoded outputs. Similarly, a 3-bit binary code applied to inputs A through C is decoded in octal code at output 0 to 7 if D = "0". High drive capability is provided at all outputs to enhance dc and dynamic performance in high fan-out applications.

The CD4028BMS is supplied in these 16-lead outline packages:

Braze Seal DIP H4S
 Frit Seal DIP H1E
 Ceramic Flatpack H3X

Pinout

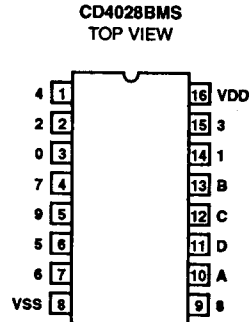

Functional Diagram

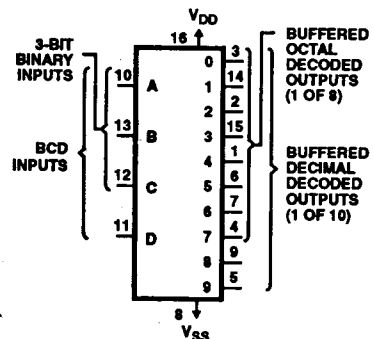

Specifications CD4028BMS

Absolute Maximum Ratings

DC Supply Voltage Range, (VDD) -0.5V to +20V
 (Voltage Referenced to VSS Terminals)
 Input Voltage Range, All Inputs -0.5V to VDD +0.5V
 DC Input Current, Any One Input ±10mA
 Operating Temperature Range -55°C to +125°C
 Package Types D, F, K, H
 Storage Temperature Range (TSTG) -65°C to +150°C
 Lead Temperature (During Soldering) +265°C
 At Distance 1/16 ± 1/32 Inch (1.59mm ± 0.79mm) from case for
 10s Maximum

Reliability Information

Thermal Resistance θ_{JA} θ_{JC}
 Ceramic DIP and FRIT Package 80°C/W 20°C/W
 Flatpack Package 70°C/W 20°C/W
 Maximum Package Power Dissipation (PD) at +125°C
 For TA = -55°C to +100°C (Package Type D, F, K) 500mW
 For TA = +100°C to +125°C (Package Type D, F, K) Derate
 Linearity at 12mW/°C to 200mW
 Device Dissipation per Output Transistor 100mW
 For TA = Full Package Temperature Range (All Package Types)
 Junction Temperature +175°C

TABLE 1. DC ELECTRICAL PERFORMANCE CHARACTERISTICS

PARAMETER	SYMBOL	CONDITIONS (NOTE 1)		GROUP A SUBGROUPS	TEMPERATURE	LIMITS		UNITS
						MIN	MAX	
Supply Current	IDD	VDD = 20V, VIN = VDD or GND		1	+25°C	-	10	µA
				2	+125°C	-	1000	µA
		VDD = 18V, VIN = VDD or GND		3	-55°C	-	10	µA
Input Leakage Current	IIL	VIN = VDD or GND	VDD = 20	1	+25°C	-100	-	nA
				2	+125°C	-1000	-	nA
				3	-55°C	-100	-	nA
Input Leakage Current	IIH	VIN = VDD or GND	VDD = 20	1	+25°C	-	100	nA
				2	+125°C	-	1000	nA
				3	-55°C	-	100	nA
Output Voltage	VOL15	VDD = 15V, No Load		1, 2, 3	+25°C, +125°C, -55°C	-	50	mV
Output Voltage	VOH15	VDD = 15V, No Load (Note 3)		1, 2, 3	+25°C, +125°C, -55°C	14.95	-	V
Output Current (Sink)	IOL5	VDD = 5V, VOUT = 0.4V		1	+25°C	0.53	-	mA
Output Current (Sink)	IOL10	VDD = 10V, VOUT = 0.5V		1	+25°C	1.4	-	mA
Output Current (Sink)	IOL15	VDD = 15V, VOUT = 1.5V		1	+25°C	3.5	-	mA
Output Current (Source)	IOH5A	VDD = 5V, VOUT = 4.6V		1	+25°C	-	-0.53	mA
Output Current (Source)	IOH5B	VDD = 5V, VOUT = 2.5V		1	+25°C	-	-1.8	mA
Output Current (Source)	IOH10	VDD = 10V, VOUT = 9.5V		1	+25°C	-	-1.4	mA
Output Current (Source)	IOH15	VDD = 15V, VOUT = 13.5V		1	+25°C	-	-3.5	mA
N Threshold Voltage	VNTH	VDD = 10V, ISS = -10µA		1	+25°C	-2.8	-0.7	V
P Threshold Voltage	VP TH	VSS = 0V, IDD = 10µA		1	+25°C	0.7	2.8	V
Functional	F	VDD = 2.8V, VIN = VDD or GND		7	+25°C	VOH > VDD/2	VOL < VDD/2	V
		VDD = 20V, VIN = VDD or GND		7	+25°C			
		VDD = 18V, VIN = VDD or GND		8A	+125°C			
		VDD = 3V, VIN = VDD or GND		8B	-55°C			
Input Voltage Low (Note 2)	VIL	VDD = 5V, VOH > 4.5V, VOL < 0.5V		1, 2, 3	+25°C, +125°C, -55°C	-	1.5	V
Input Voltage High (Note 2)	VIH	VDD = 5V, VOH > 4.5V, VOL < 0.5V		1, 2, 3	+25°C, +125°C, -55°C	3.5	-	V
Input Voltage Low (Note 2)	VIL	VDD = 15V, VOH > 13.5V, VOL < 1.5V		1, 2, 3	+25°C, +125°C, -55°C	-	4	V
Input Voltage High (Note 2)	VIH	VDD = 15V, VOH > 13.5V, VOL < 1.5V		1, 2, 3	+25°C, +125°C, -55°C	11	-	V

NOTES: 1. All voltages referenced to device GND, 100% testing being implemented. 2. Go/No Go test with limits applied to inputs. 3. For accuracy, voltage is measured differentially to VDD. Limit is 0.050V max.

7
LOGIC

Specifications CD4028BMS

TABLE 2. AC ELECTRICAL PERFORMANCE CHARACTERISTICS

PARAMETER	SYMBOL	CONDITIONS (NOTE 1, 2)	GROUP A SUBGROUPS	TEMPERATURE	LIMITS		UNITS
					MIN	MAX	
Propagation Delay	TPHL TPLH	VDD = 5V, VIN = VDD or GND	9	+25°C	-	350	ns
			10, 11	+125°C, -55°C	-	473	ns
Transition Time	TTHL TTLH	VDD = 5V, VIN = VDD or GND	9	+25°C	-	200	ns
			10, 11	+125°C, -55°C	-	270	ns

NOTES:

1. CL = 50pF, RL = 200K, Input TR, TF < 20ns.
2. -55°C and +125°C limits guaranteed, 100% testing being implemented.

TABLE 3. ELECTRICAL PERFORMANCE CHARACTERISTICS

PARAMETER	SYMBOL	CONDITIONS	NOTES	TEMPERATURE	LIMITS		UNITS
					MIN	MAX	
Supply Current	IDD	VDD = 5V, VIN = VDD or GND	1, 2	-55°C, +25°C	-	5	μA
				+125°C	-	150	μA
		VDD = 10V, VIN = VDD or GND	1, 2	-55°C, +25°C	-	10	μA
				+125°C	-	300	μA
		VDD = 15V, VIN = VDD or GND	1, 2	-55°C, +25°C	-	10	μA
				+125°C	-	600	μA
Output Voltage	VOL	VDD = 5V, No Load	1, 2	+25°C, +125°C, -55°C	-	50	mV
Output Voltage	VOL	VDD = 10V, No Load	1, 2	+25°C, +125°C, -55°C	-	50	mV
Output Voltage	VOH	VDD = 5V, No Load	1, 2	+25°C, +125°C, -55°C	4.95	-	V
Output Voltage	VOH	VDD = 10V, No Load	1, 2	+25°C, +125°C, -55°C	9.95	-	V
Output Current (Sink)	IOL5	VDD = 5V, VOUT = 0.4V	1, 2	+125°C	0.36	-	mA
				-55°C	0.64	-	mA
Output Current (Sink)	IOL10	VDD = 10V, VOUT = 0.5V	1, 2	+125°C	0.9	-	mA
				-55°C	1.6	-	mA
Output Current (Sink)	IOL15	VDD = 15V, VOUT = 1.5V	1, 2	+125°C	2.4	-	mA
				-55°C	4.2	-	mA
Output Current (Source)	IOH5A	VDD = 5V, VOUT = 4.6V	1, 2	+125°C	-	-0.36	mA
				-55°C	-	-0.64	mA
Output Current (Source)	IOH5B	VDD = 5V, VOUT = 2.5V	1, 2	+125°C	-	-1.15	mA
				-55°C	-	-2.0	mA
Output Current (Source)	IOH10	VDD = 10V, VOUT = 9.5V	1, 2	+125°C	-	-0.9	mA
				-55°C	-	-1.6	mA
Output Current (Source)	IOH15	VDD = 15V, VOUT = 13.5V	1, 2	+125°C	-	-2.4	mA
				-55°C	-	-4.2	mA
Input Voltage Low	VIL	VDD = 10V, VOH > 9V, VOL < 1V	1, 2	+25°C, +125°C, -55°C	-	3	V
Input Voltage High	VIH	VDD = 10V, VOH > 9V, VOL < 1V	1, 2	+25°C, +125°C, -55°C	7	-	V

Specifications CD4028BMS

TABLE 3. ELECTRICAL PERFORMANCE CHARACTERISTICS (Continued)

PARAMETER	SYMBOL	CONDITIONS	NOTES	TEMPERATURE	LIMITS		UNITS
					MIN	MAX	
Propagation Delay	TPHL	VDD = 10V	1, 2, 3	+25°C	-	160	ns
	TPLH	VDD = 15V	1, 2, 3	+25°C	-	120	ns
Transition Time	TTHL	VDD = 10V	1, 2, 3	+25°C	-	100	ns
	TTLH	VDD = 15V	1, 2, 3	+25°C	-	80	ns
Input Capacitance	CIN		1, 2	+25°C	-	7.5	pF

NOTES:

1. All voltages referenced to device GND.
2. The parameters listed on Table 3 are controlled via design or process and are not directly tested. These parameters are characterized on initial design release and upon design changes which would affect these characteristics.
3. CL = 50pF, RL = 200K, Input TR, TF < 20ns.

TABLE 4. POST IRRADIATION ELECTRICAL PERFORMANCE CHARACTERISTICS

PARAMETER	SYMBOL	CONDITIONS	NOTES	TEMPERATURE	LIMITS		UNITS
					MIN	MAX	
Supply Current	IDD	VDD = 20V, VIN = VDD or GND	1, 4	+25°C	-	25	µA
N Threshold Voltage	VNTH	VDD = 10V, ISS = -10µA	1, 4	+25°C	-2.8	-0.2	V
N Threshold Voltage Delta	ΔVTN	VDD = 10V, ISS = -10µA	1, 4	+25°C	-	±1	V
P Threshold Voltage	VTP	VSS = 0V, IDD = 10µA	1, 4	+25°C	0.2	2.8	V
P Threshold Voltage Delta	ΔVTP	VSS = 0V, IDD = 10µA	1, 4	+25°C	-	±1	V
Functional	F	VDD = 18V, VIN = VDD or GND	1	+25°C	VOH > VDD/2	VOL < VDD/2	V
		VDD = 3V, VIN = VDD or GND					
Propagation Delay Time	TPHL	VDD = 5V	1, 2, 3, 4	+25°C	-	1.35 x +25°C Limit	ns
	TPLH						

- NOTES: 1. All voltages referenced to device GND. 3. See Table 2 for +25°C limit.
 2. CL = 50pF, RL = 200K, Input TR, TF < 20ns. 4. Read and Record

TABLE 5. BURN-IN AND LIFE TEST DELTA PARAMETERS +25°C

PARAMETER	SYMBOL	DELTA LIMIT
Supply Current - MSI-2	IDD	± 1.0µA
Output Current (Sink)	IOL5	± 20% x Pre-Test Reading
Output Current (Source)	IOH5A	± 20% x Pre-Test Reading

TABLE 6. APPLICABLE SUBGROUPS

CONFORMANCE GROUP	MIL-STD-883 METHOD	GROUP A SUBGROUPS	READ AND RECORD
Initial Test (Pre Burn-In)	100% 5004	1, 7, 9	IDD, IOL5, IOH5A
Interim Test 1 (Post Burn-In)	100% 5004	1, 7, 9	IDD, IOL5, IOH5A
Interim Test 2 (Post Burn-In)	100% 5004	1, 7, 9	IDD, IOL5, IOH5A
PDA (Note 1)	100% 5004	1, 7, 9, Deltas	
Interim Test 3 (Post Burn-In)	100% 5004	1, 7, 9	IDD, IOL5, IOH5A

7
LOGIC

Specifications CD4028BMS

TABLE 6. APPLICABLE SUBGROUPS (Continued)

CONFORMANCE GROUP		MIL-STD-883 METHOD	GROUP A SUBGROUPS	READ AND RECORD
PDA (Note 1)		100% 5004	1, 7, 9, Deltas	
Final Test		100% 5004	2, 3, 8A, 8B, 10, 11	
Group A		Sample 5005	1, 2, 3, 7, 8A, 8B, 9, 10, 11	
Group B	Subgroup B-5	Sample 5005	1, 2, 3, 7, 8A, 8B, 9, 10, 11, Deltas	Subgroups 1, 2, 3, 9, 10, 11
	Subgroup B-6	Sample 5005	1, 7, 9	
Group D		Sample 5005	1, 2, 3, 8A, 8B, 9	Subgroups 1, 2, 3

NOTE: 1. 5% Parametric, 3% Functional; Cumulative for Static 1 and 2.

TABLE 7. TOTAL DOSE IRRADIATION

CONFORMANCE GROUPS	MIL-STD-883 METHOD	TEST		READ AND RECORD	
		PRE-IRRAD	POST-IRRAD	PRE-IRRAD	POST-IRRAD
Group E Subgroup 2	5005	1, 7, 9	Table 4	1, 9	Table 4

TABLE 8. BURN-IN AND IRRADIATION TEST CONNECTIONS

FUNCTION	OPEN	GROUND	VDD	9V ± 0.5V	OSCILLATOR	
					50kHz	25kHz
Static Burn-In 1 Note 1	1 - 7, 9, 14, 15	8, 10 - 13	16			
Static Burn-In 2 Note 1	1 - 7, 9, 14, 15	8	10 - 13, 16			
Dynamic Burn-In Note 1	-	8	16	1 - 7, 9, 14, 15	10, 12, 13	11
Irradiation Note 2	1 - 7, 9, 14, 15	8	10 - 13, 16			

NOTE:

1. Each pin except VDD and GND will have a series resistor of 10K ± 5%, VDD = 18V ± 0.5V
2. Each pin except VDD and GND will have a series resistor of 47K ± 5%; Group E, Subgroup 2, sample size is 4 dice/wafer, 0 failures, VDD = 10V ± 0.5V

Logic Diagram

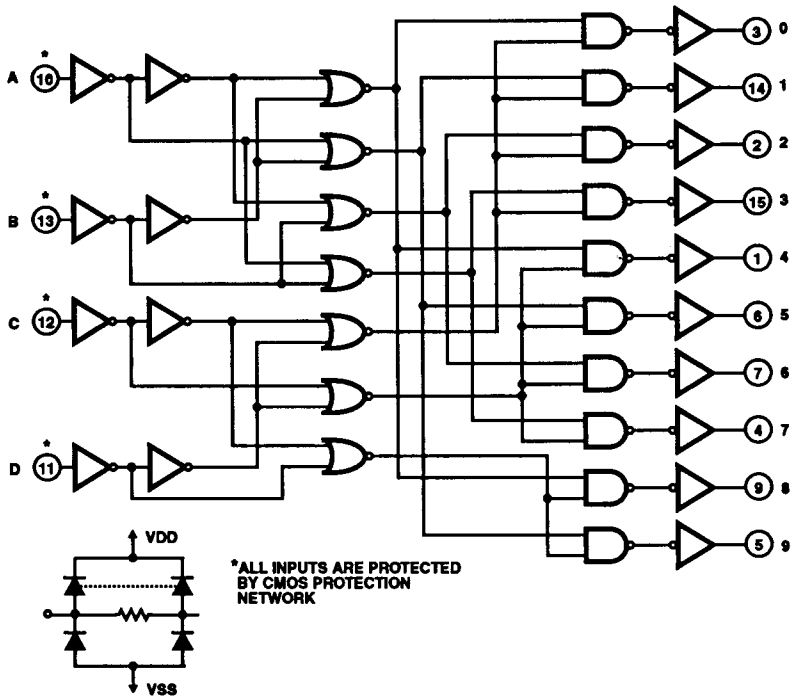

TABLE 1. TRUTH TABLE

D	C	B	A	0	1	2	3	4	5	6	7	8	9
0	0	0	0	1	0	0	0	0	0	0	0	0	0
0	0	0	1	0	1	0	0	0	0	0	0	0	0
0	0	1	0	0	0	1	0	0	0	0	0	0	0
0	0	1	1	0	0	0	1	0	0	0	0	0	0
0	1	0	0	0	0	0	0	1	0	0	0	0	0
0	1	0	1	0	0	0	0	0	1	0	0	0	0
0	1	1	0	0	0	0	0	0	0	1	0	0	0
0	1	1	1	0	0	0	0	0	0	0	1	0	0
1	0	0	0	0	0	0	0	0	0	0	0	1	0
1	0	0	1	0	0	0	0	0	0	0	0	0	1
1	0	1	0	0	0	0	0	0	0	0	0	0	0
1	0	1	1	0	0	0	0	0	0	0	0	0	0
1	1	0	0	0	0	0	0	0	0	0	0	0	0
1	1	0	1	0	0	0	0	0	0	0	0	0	0
1	1	1	0	0	0	0	0	0	0	0	0	0	0
1	1	1	1	0	0	0	0	0	0	0	0	0	0

1 = HIGH LEVEL

0 = LOW LEVEL

Typical Performance Characteristics

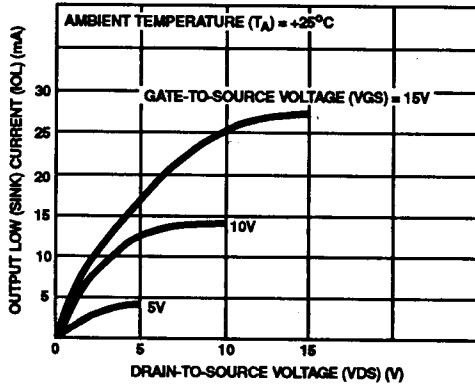

FIGURE 1. TYPICAL OUTPUT LOW (SINK) CURRENT CAPACITANCE

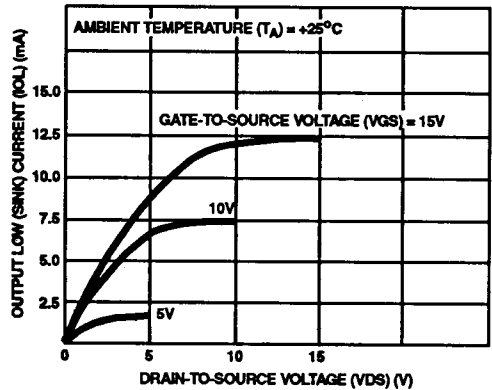

FIGURE 2. MINIMUM OUTPUT LOW (SINK) CURRENT CAPACITANCE

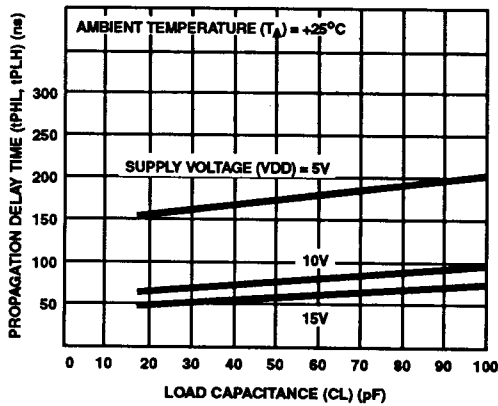

FIGURE 3. TYPICAL PROPAGATION DELAY TIME AS A FUNCTION OF LOAD CAPACITANCE

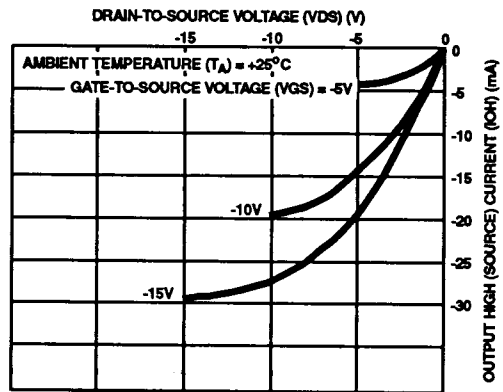

FIGURE 4. TYPICAL OUTPUT HIGH (SOURCE) CURRENT CHARACTERISTICS

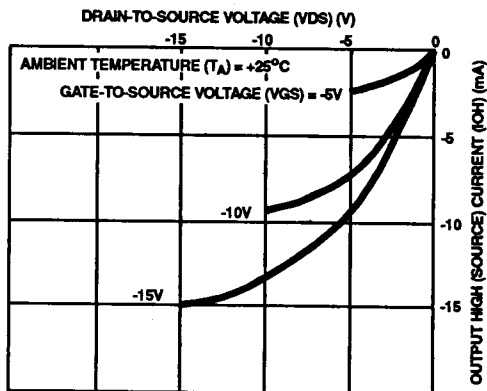

FIGURE 5. MINIMUM OUTPUT HIGH (SOURCE) CURRENT CHARACTERISTICS

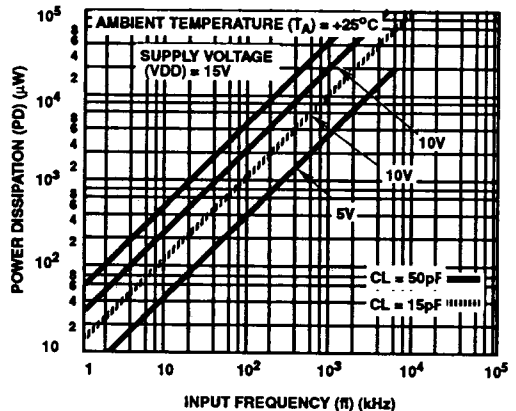

FIGURE 6. TYPICAL DYNAMIC POWER DISSIPATION AS A FUNCTION OF INPUT FREQUENCY

Typical Performance Characteristics (Continued)

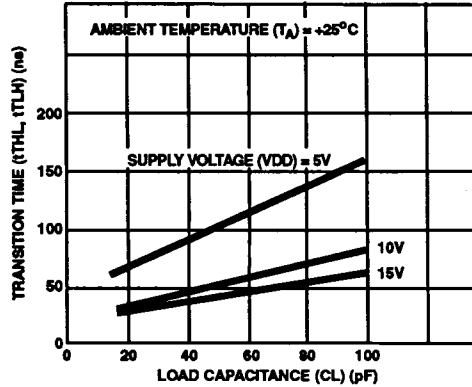

FIGURE 7. TYPICAL TRANSITION TIME AS A FUNCTION OF LOAD CAPACITANCE

Typical Applications

The circuit shown in Figure 8 converts any 4-bit code to a decimal or hexadecimal code. Table 2 shows a number of codes and the decimal or hexadecimal number in these codes which must be applied to the input terminals of the CD4028BMS to select a particular output. For example: in order to get a high on output number 8 the input must be either an 8 expressed in 4-bit Binary code, a 15 expressed in 4-Bit Gray code, or a 5 expressed in Excess-3 code.

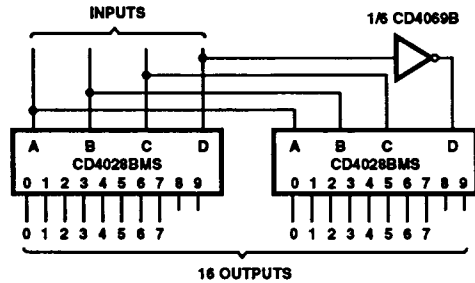

FIGURE 8. CODE CONVERSION CIRCUIT

TABLE 2. CODE CONVERSION CHART

INPUTS				INPUT CODES				OUTPUT NUMBER																		
				HEXA-DECIMAL		DECIMAL																				
D	C	B	A	4-BIT BINARY	4-BIT GRAY	EXCESS-3	EXCESS-3 GRAY	AIKEN	4-2-2-1	0	1	2	3	4	5	6	7	8	9	10	11	12	13	14	15	
0	0	0	0	0	0			0	0	1	0	0	0	0	0	0	0	0	0	0	0	0	0	0	0	0
0	0	0	1	1	1			1	1	0	1	0	0	0	0	0	0	0	0	0	0	0	0	0	0	0
0	0	1	0	2	3			0	2	2	0	0	1	0	0	0	0	0	0	0	0	0	0	0	0	0
0	0	1	1	3	2	0	3	3		0	0	0	1	0	0	0	0	0	0	0	0	0	0	0	0	0
0	1	0	0	4	7	1	4	4		0	0	0	0	1	0	0	0	0	0	0	0	0	0	0	0	0
0	1	0	1	5	6	2			3	0	0	0	0	0	1	0	0	0	0	0	0	0	0	0	0	0
0	1	1	0	6	4	3	1		4	0	0	0	0	0	0	1	0	0	0	0	0	0	0	0	0	0
0	1	1	1	7	5	4	2			0	0	0	0	0	0	0	1	0	0	0	0	0	0	0	0	0
1	0	0	0	8	15	5				0	0	0	0	0	0	0	0	1	0	0	0	0	0	0	0	0
1	0	0	1	9	14	6			5	0	0	0	0	0	0	0	0	0	1	0	0	0	0	0	0	0
1	0	1	0	10	12	7	9		6	0	0	0	0	0	0	0	0	0	0	1	0	0	0	0	0	0

CD4028BMS

TABLE 2. CODE CONVERSION CHART (Continued)

INPUTS				INPUT CODES					OUTPUT NUMBER																
				HEXA-DECIMAL		DECIMAL																			
D	C	B	A	4-BIT BINARY	4-BIT GRAY	EXCESS-3	EXCESS-3 GRAY	AIKEN	4-2-2-1	0	1	2	3	4	5	6	7	8	9	10	11	12	13	14	15
1	0	1	1	11	13	8		5		0	0	0	0	0	0	0	0	0	0	0	1	0	0	0	0
1	1	0	0	12	8	9	5	6		0	0	0	0	0	0	0	0	0	0	0	0	1	0	0	0
1	1	0	1	13	9		6	7	7	0	0	0	0	0	0	0	0	0	0	0	0	0	1	0	0
1	1	1	0	14	11		8	8	8	0	0	0	0	0	0	0	0	0	0	0	0	0	0	1	0
1	1	1	1	15	10		7	9	9	0	0	0	0	0	0	0	0	0	0	0	0	0	0	0	1

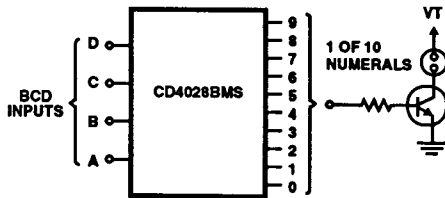

*(TRADEMARK) BURROUGHS CORP.

TUBE REQUIREMENTS

TYPE		VT(Vdc)	NUMERAL mA/
BURROUGHS	B4081	170	14
	B4336/718	170	2
	B4032	170	14
	B4021	120	14

TRANSISTOR CHARACTERISTICS

Leakage with transistor cutoff $\leq 0.05\text{mA}$
 $V(BR)_{CEO} \geq 70\text{V}$

FIGURE 9. NEON READOUT (NIXIE TUBE*) DISPLAY APPLICATION

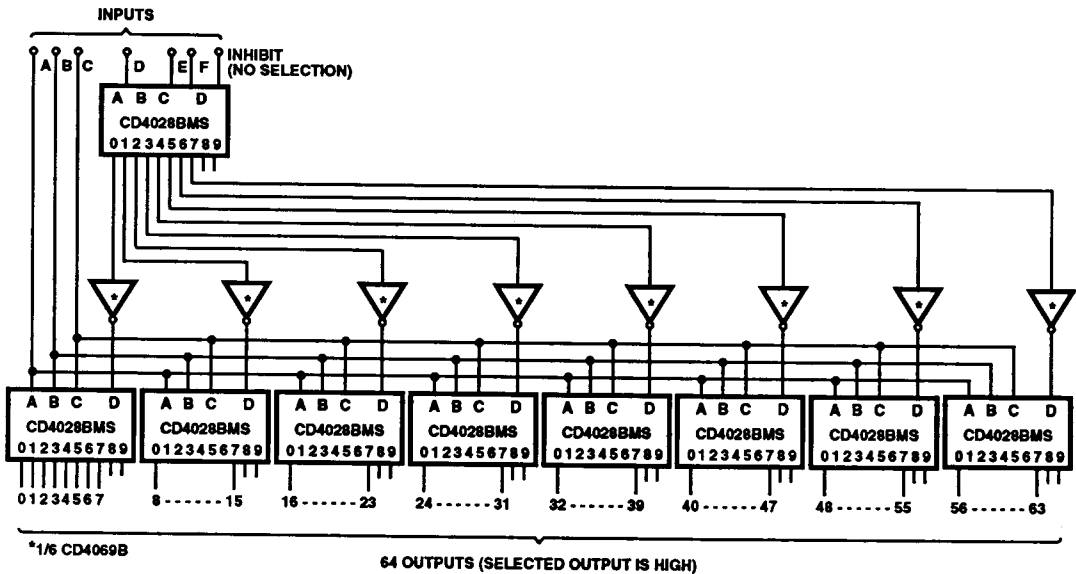

*1/6 CD4069B

64 OUTPUTS (SELECTED OUTPUT IS HIGH)

FIGURE 10. 6-BIT BINARY TO 1-OF-64 ADDRESS DECODER

Chip Dimensions and Pad Layout

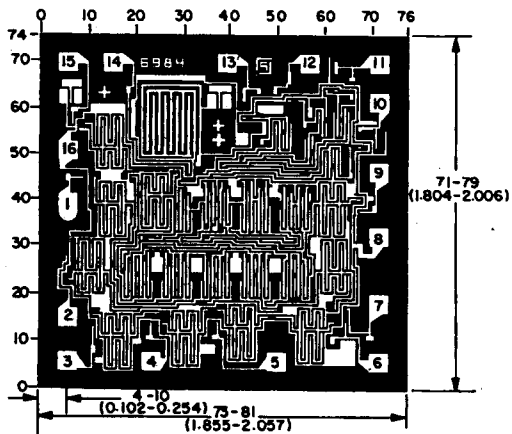

Dimensions in parentheses are in millimeters and are derived from the basic inch dimensions as indicated. Grid graduations are in mils (10^{-3} inch)

METALLIZATION: Thickness: $11\text{k}\text{\AA} - 14\text{k}\text{\AA}$, AL.

PASSIVATION: $10.4\text{k}\text{\AA} - 15.6\text{k}\text{\AA}$, Silane

BOND PADS: 0.004 inches X 0.004 inches MIN

DIE THICKNESS: 0.0198 inches - 0.0218 inches